

Robotic Pool Cleaner Mass 13

EN User Instructions

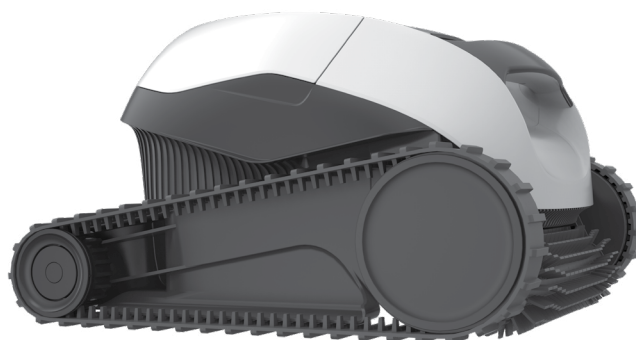

EN

Robotic Pool Cleaner Mass 13

User Instructions

Contents

1. INTRODUCTION	3
2. SPECIFICATIONS	3
3. WARNINGS AND CAUTIONS	3
3.1 Warnings.....	3
3.2 Cautions.....	3
4. POOL CLEANER PARTS	4
5. USING THE POOL CLEANER	5
5.1 Setup	5
5.2 Putting the Pool Cleaner into the pool	6
5.3 Removing the Pool Cleaner from the pool	6
6. CLEANING THE FILTER BASKET.....	8
6.1 Cleaning after use	8
6.2 Periodic cleaning	9
7. CLEANING THE NET CANISTER	10
8. CLEANING THE IMPELLER	11
9. OFF-SEASON STORAGE	12
10. TROUBLESHOOTING	12

Robotic Pool Cleaner Mass 13

User Instructions

1. INTRODUCTION

Thank you for purchasing a Maytronics Robotic Pool Cleaner.

We are sure that your Maytronics Robotic Pool Cleaner will provide you with reliable, convenient and cost-effective pool cleaning. Its reliable filtration in all pool conditions and active brushing, enhance pool hygiene.

Robotic Pool Cleaners by Maytronics deliver advanced cleaning technologies, long-lasting performance and easy maintenance. You and your family will be free to enjoy your swim with full confidence that your pool is completely clean.

2. SPECIFICATIONS

Motor protection: IP 68

Minimum depth: 0.4 m (1.33 ft)

Maximum depth: 5 m (16.4 ft)

Digital Power supply

Input: 100-125 AC Volts / 200-230 AC Volts

50-60 Hertz

Output: <30 VDC

IP 54

3. WARNINGS AND CAUTIONS

3.1 Warnings



- Use the originally supplied power supply only
- Ensure the electrical outlet is protected by a ground fault interrupter (GFI) or an earth leakage interrupter (ELI)
- Keep the power supply out of standing water
- Position the power supply at least 3.5 m (12 ft) away from the edge of the pool
- Do not enter the pool while the Pool Cleaner is working
- Unplug the power supply before servicing
- Keep the Robotic Pool Cleaner out of the reach of children or persons with reduced physical, sensory, or mental capabilities, or lack of experience and knowledge, unless they have been given supervision or instruction.

3.2 Cautions

Use the Pool Cleaner in the following water conditions only:

Chlorine	4 ppm max.
pH	7.0-7.8
Temperature	6-35°C (43-95°F)
NaCl	5000 ppm max.

4. POOL CLEANER PARTS

► Robotic Pool Cleaner Model Mass 13

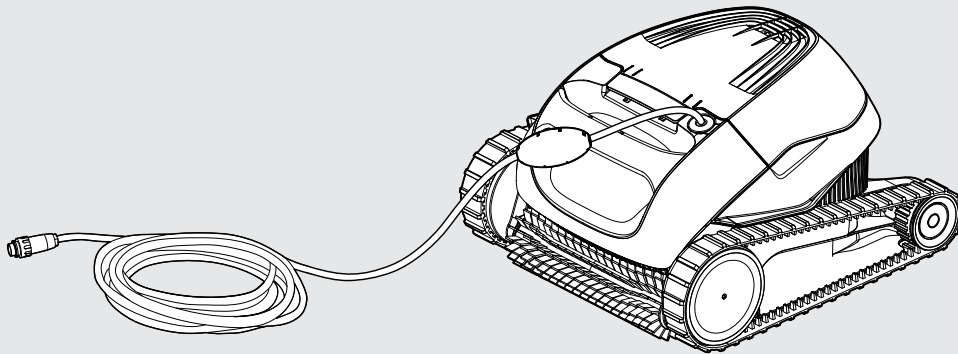

► Power supply unit

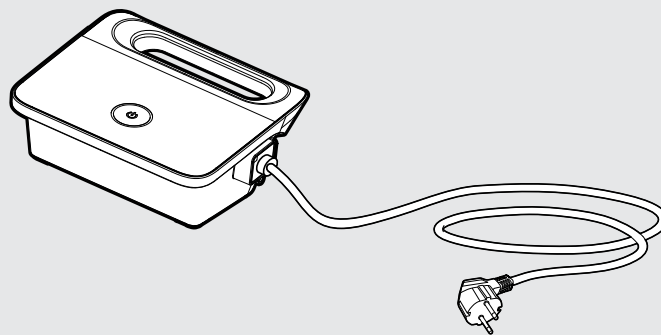

► Filtration - options

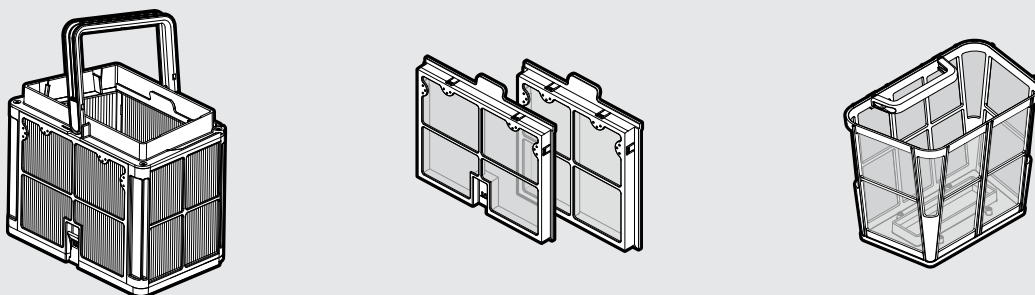

5. USING THE POOL CLEANER

5.1 Setup

Before using the Pool Cleaner for the first time, perform the following steps:

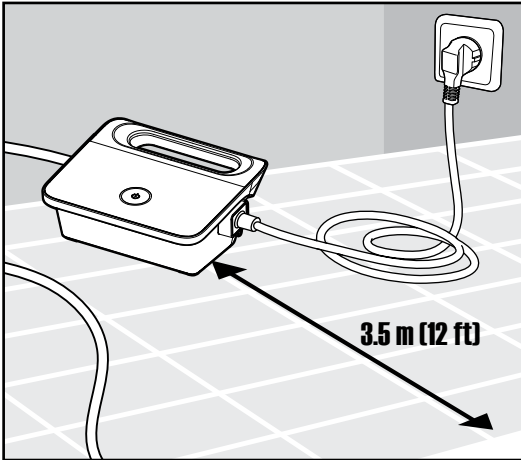

5.1.1 Position the power supply so that it is approximately in the middle of the long side of the pool at a distance of 3.5 m (12 ft).

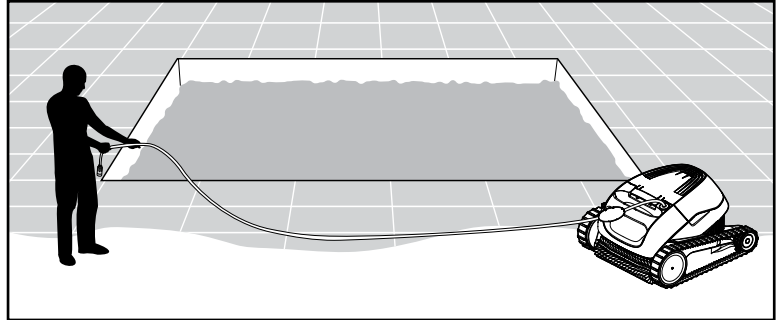

5.1.2 Unwind the cable and stretch it out completely so that it has no kinks.

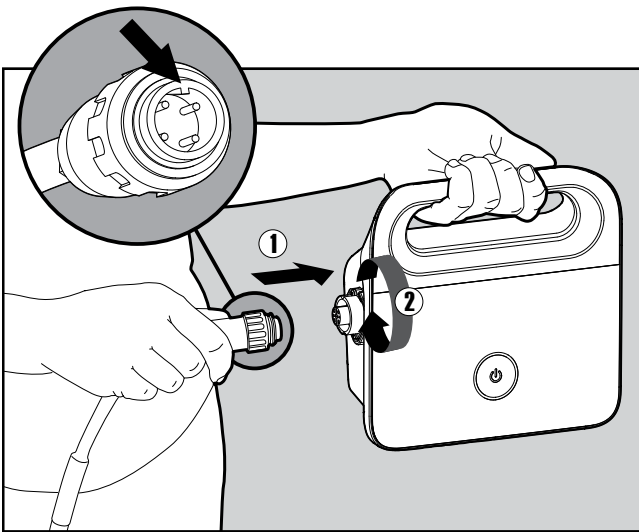

5.1.3 Attach the floating cable to the power supply by inserting it with the notch on the connector (1), lined up with the groove in the socket on the power supply, and turning clockwise (2).

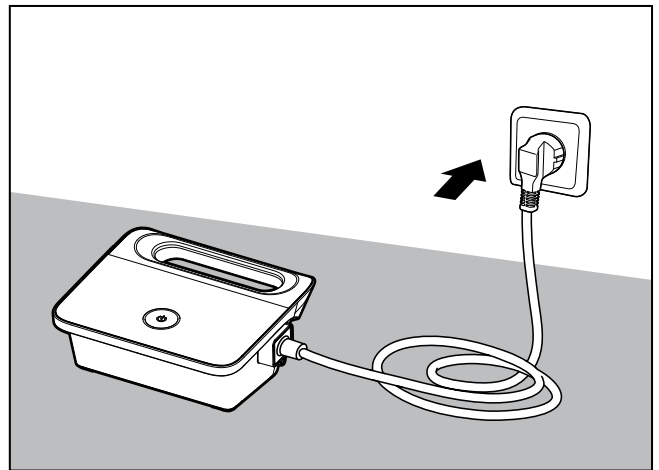

5.1.4 Plug in the power supply and leave it in the OFF position.

5.2 Putting the Pool Cleaner into the pool

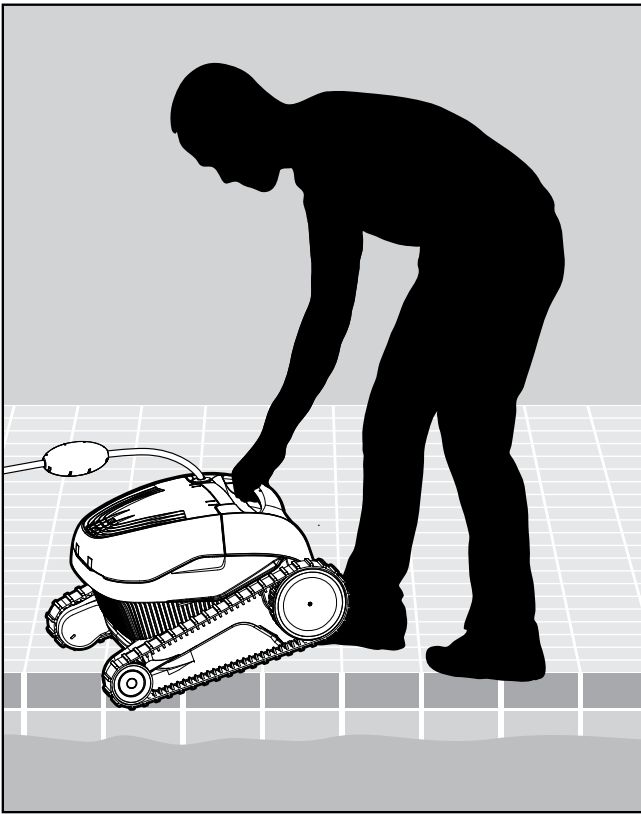

5.2.1 Put the Pool Cleaner into the pool. Release the Pool Cleaner and let it sink to the floor of the pool. Make sure that the floating cable is free of any obstructions.

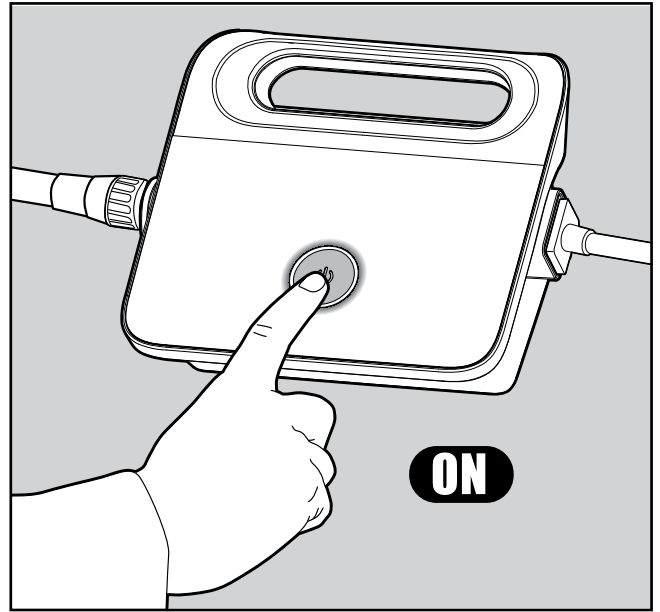

5.2.2 Turn the power supply ON. The Pool Cleaner will now operate until it has reached the end of the cleaning cycle.

5.3 Removing the Pool Cleaner from the pool

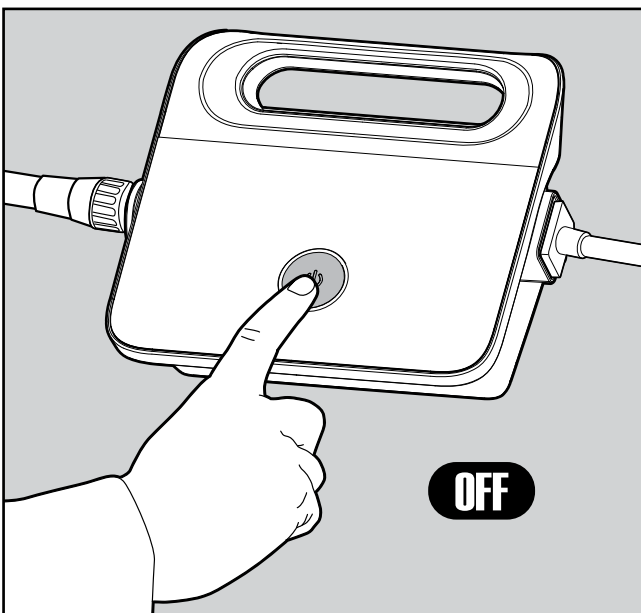

5.3.1



Turn OFF and unplug the power supply.

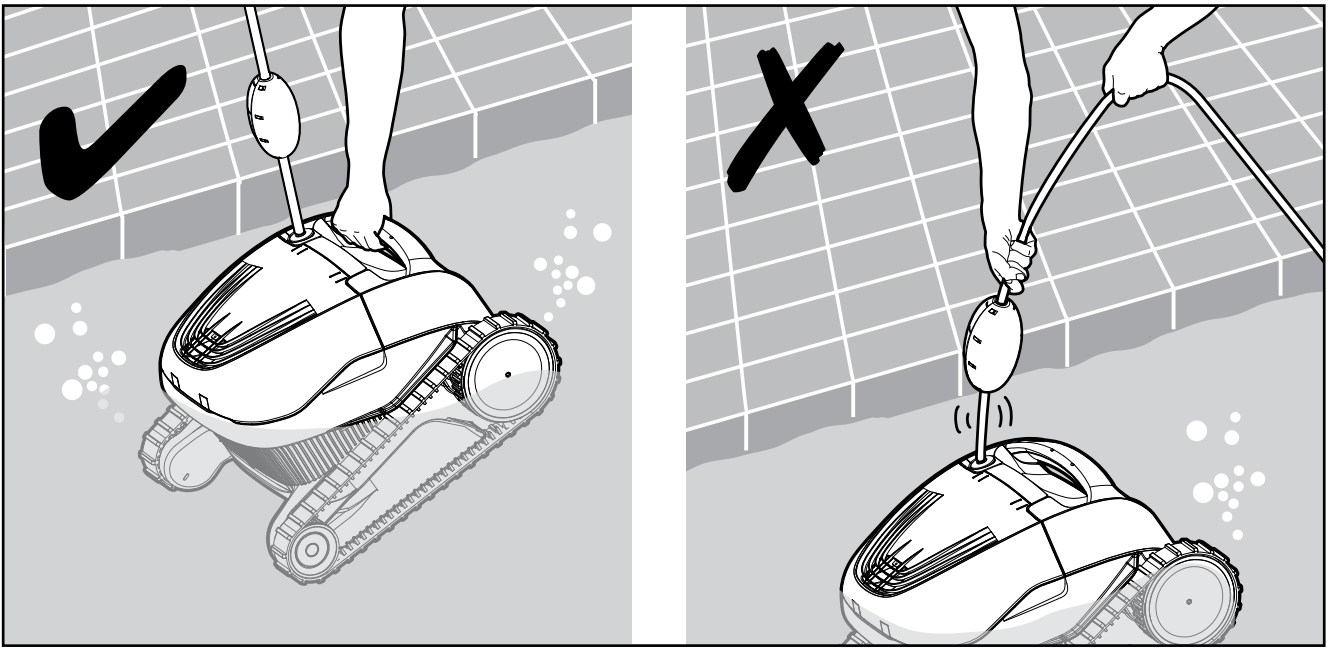

5.3.2 Using the floating cable, bring the Pool Cleaner to the pool's edge. Using the handle, remove the Pool Cleaner from the pool.

 **DO NOT PULL THE POOL CLEANER FROM THE POOL USING THE CABLE.**

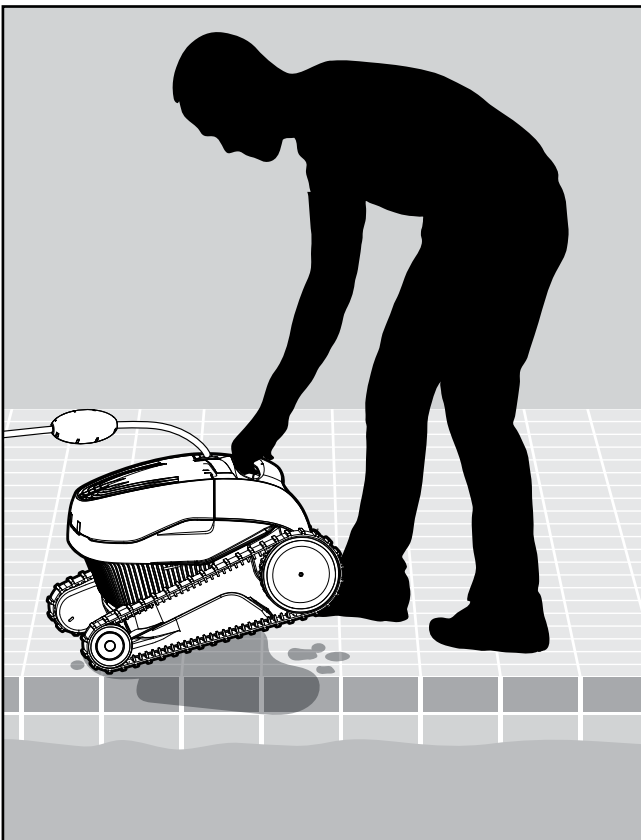

5.3.3 Place the Pool Cleaner on the edge of the pool and let the water drain out.

6. CLEANING THE FILTER BASKET

 Make sure the power supply is switched off and unplugged.

It is highly recommended to clean the filter basket after each cleaning cycle.

Note: Do not let the filter basket dry out before cleaning.

6.1 Cleaning after use - removing and cleaning the filter basket

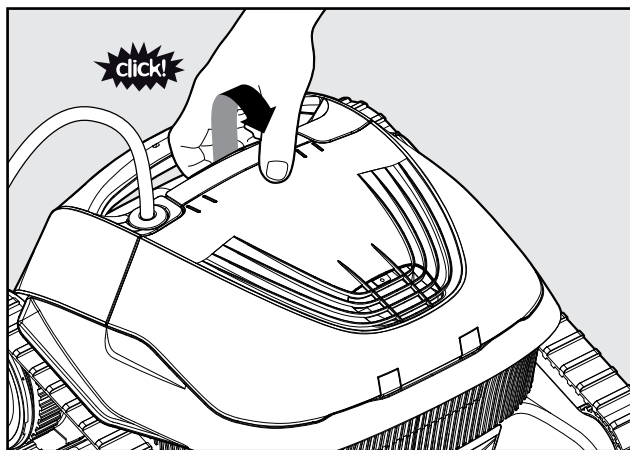

6.1.1 Open the filter cover.

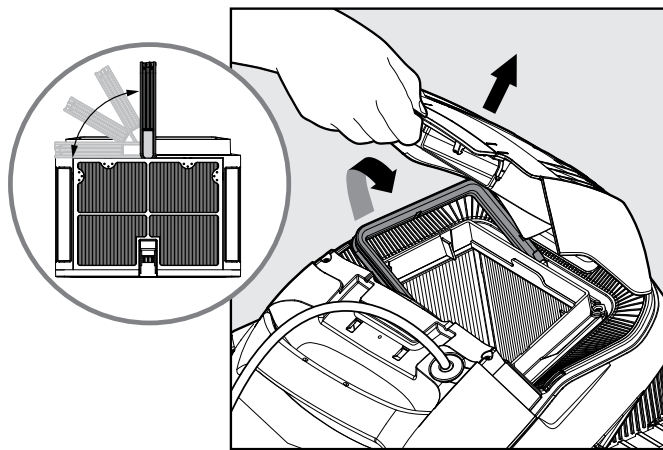

6.1.2 Upon opening the filter cover, the handle will lift independently.

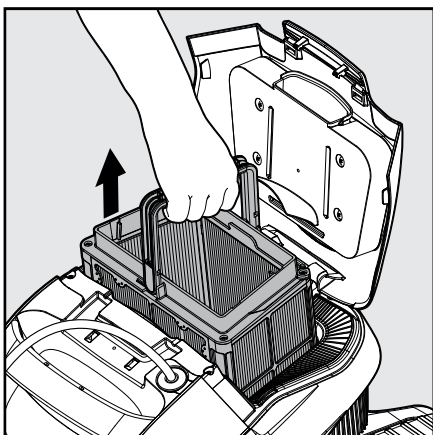

6.1.3 Lift up the basket.

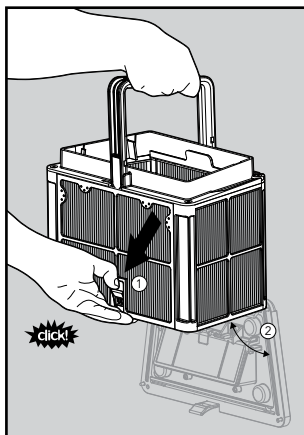

6.1.4 Open the latch to release the bottom lid in order to remove the debris.

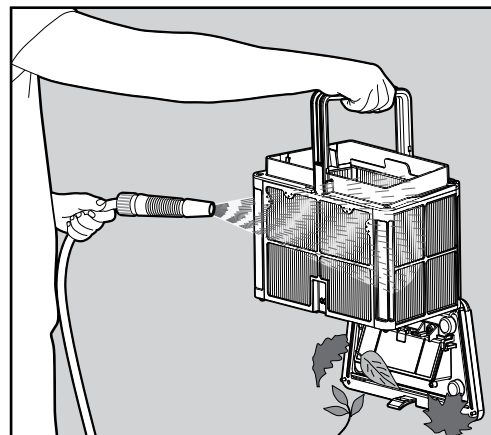

6.1.5 Clean the filter basket with a hose.

6.2 Periodic cleaning – recommended at least once a month

Dismantle the 2 ultra-fine filter panels of the basket, according to the following steps:

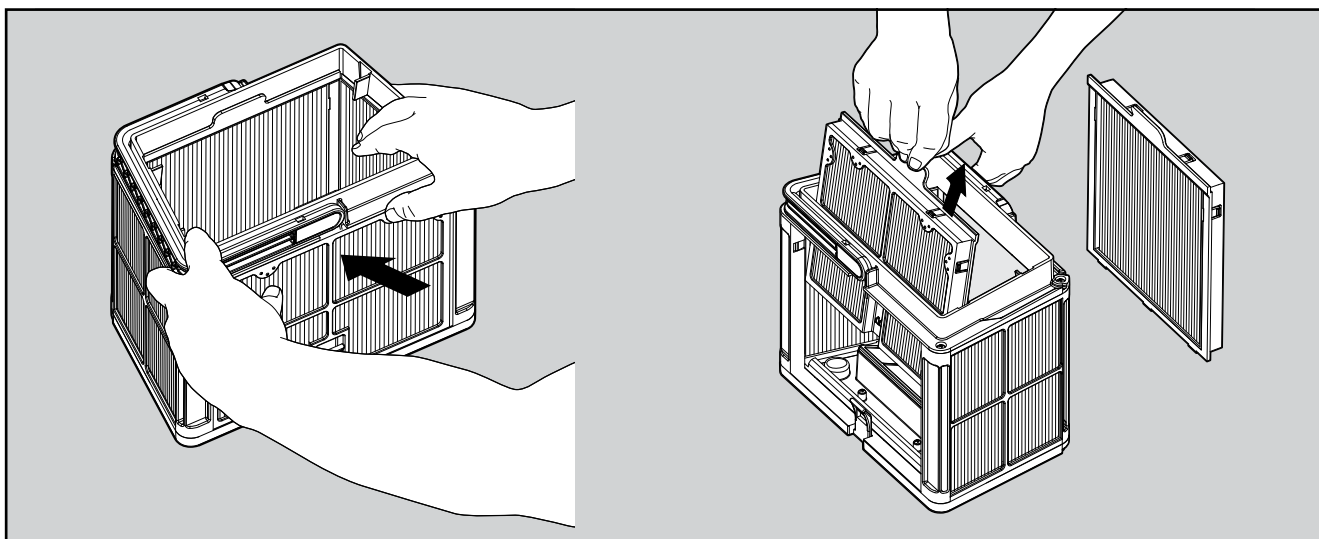

6.2.1 Dismantle the 2 panels using your thumbs.

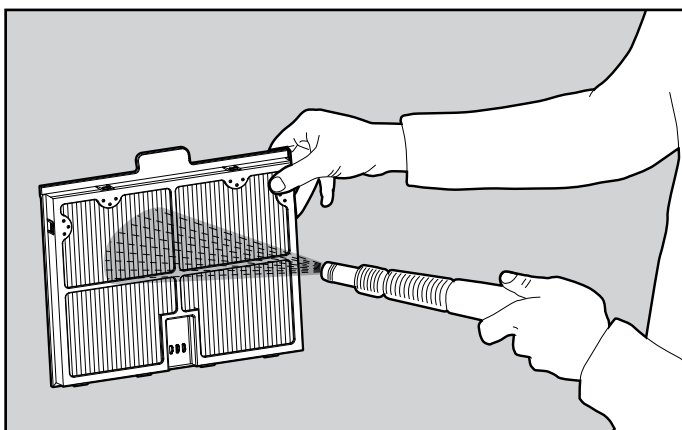

6.2.2 Clean the filter panels with a hose.

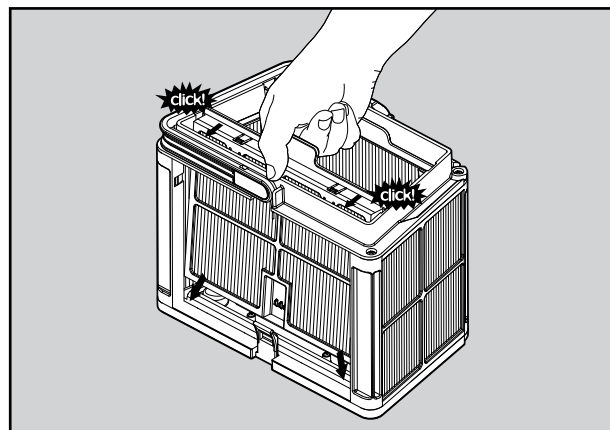

6.2.3 Assemble the filter panels.

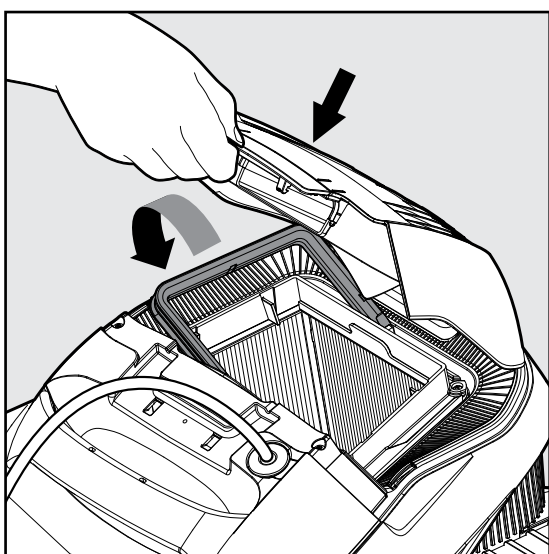

6.2.4 Insert the clean filter basket and close the filter cover.

7. CLEANING THE NET CANISTER

 Make sure the power supply is switched off and unplugged.

It is highly recommended to clean the net canister after each cleaning cycle.

Note: Do not let the net canister dry out before cleaning.

7.1 Cleaning after use - removing and cleaning the net canister

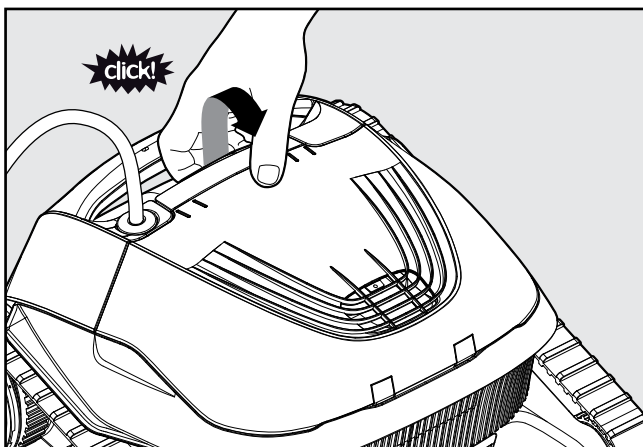

7.1.1 Open the filter cover.

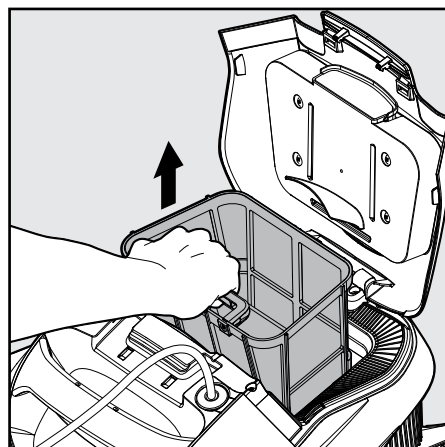

7.1.2 Lift up the net canister.

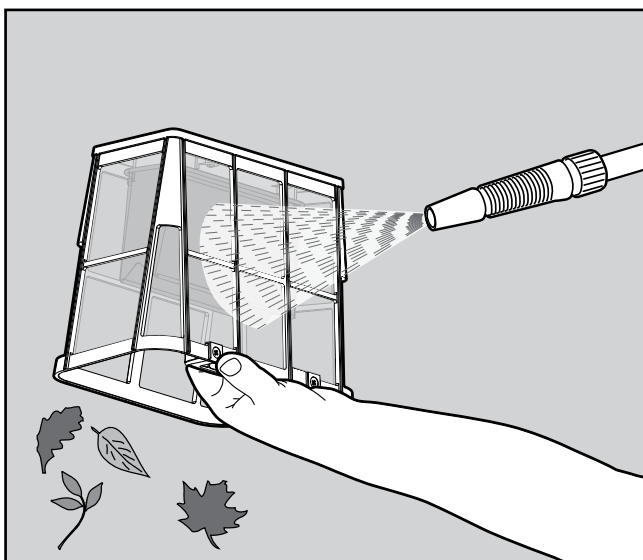

7.1.3 Clean the net canister with a hose.

8. CLEANING THE IMPELLER

If you notice debris trapped in the impeller:



Make sure the power supply is switched off and unplugged.

8.1 Clean the debris trapped in the impeller opening, according to the following steps:

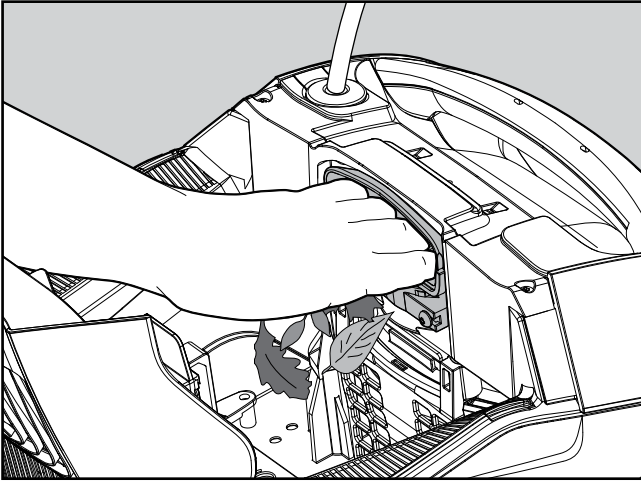

8.1.1 If the debris is not reachable follow the next steps.

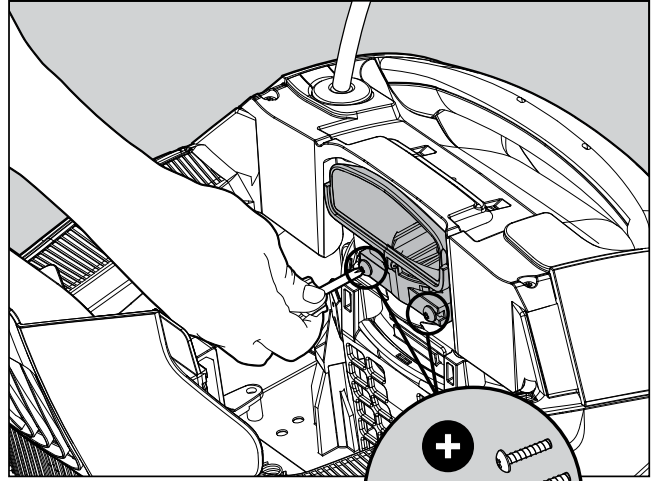

8.1.2 Using a short screwdriver open the 2 screws.

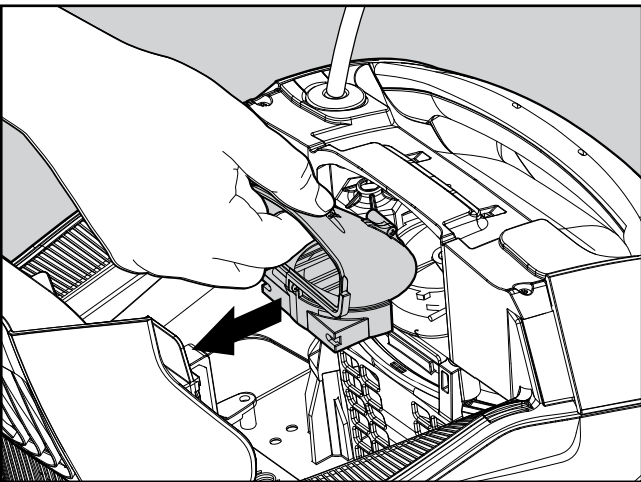

8.1.3 Pull the impeller cover backwards to release it. Clean the debris trapped around the impeller. Assemble the impeller cover.

9. OFF-SEASON STORAGE

If the Pool Cleaner will not be in use for an extended period of time, perform the following storage steps:

- Make sure that no water is left in the Pool Cleaner
- Thoroughly clean the filter basket and panels / canister and insert in place
- Roll up the cable so that it has no kinks
- Store the Pool Cleaner in a protected area out of direct sun/rain/frost, at a temperature of between 5°-45°C/41°-113°F

10. TROUBLESHOOTING

If the suggested solutions do not solve the problem, please contact your dealer or Service Center.

Symptom	Possible reason	Corrective action
The power-supply or its switch led are not working.	<ul style="list-style-type: none"> • No voltage in the power socket in the wall. • The power supply is not switched ON. • The power cable is not well connected into the power supply inlet. 	<ul style="list-style-type: none"> • Check that there is voltage in the power socket in the wall. • Check that the power supply is plugged in and turned ON. • Check that the power cable is securely connected all the way into the power supply. • Turn the power supply off. Wait 30 seconds then turn it back on.
The Pool Cleaner does not move.	<ul style="list-style-type: none"> • The floating cable is not well connected into the power supply outlet. • An obstacle blocks the impeller, tracks or wheels. 	<ul style="list-style-type: none"> • Check that the floating cable is securely connected all the way into the power supply. • Unplug the power supply. Open the impeller cover and check that nothing is trapped in the impeller. Verify that nothing blocks the tracks or wheels.
The Pool Cleaner is moving in circles.	<ul style="list-style-type: none"> • Clogged filter basket/canister. • Debris stuck in the impeller-house or impeller-cover. • Power supply incorrectly positioned. • Algae or pool water is out of Spec. 	<ul style="list-style-type: none"> • Clean the filter basket/canister. • Remove debris stuck in the impeller-house or impeller-cover (according to the drawings). • Place power supply in a position so that the Pool Cleaner can freely reach all the pool area. • Correct pool and water conditions.
The Pool Cleaner does not turn or moves in one direction only.	<ul style="list-style-type: none"> • Debris stuck in the impeller-house or impeller-cover. 	<ul style="list-style-type: none"> • Remove debris stuck in the impeller-house or impeller-cover (according to the drawings).
The Pool Cleaner moves but does not clean the pool.	<ul style="list-style-type: none"> • Clogged filter basket/canister. • Debris stuck in the impeller-house or impeller-cover. 	<ul style="list-style-type: none"> • Clean the filter basket/canister. • Remove debris stuck in the impeller-house or impeller-cover (according to the drawings).
The Pool Cleaner cleans only part of the pool.	<ul style="list-style-type: none"> • Power supply incorrectly positioned. • Not enough floating is released for the correct operation of the Pool Cleaner. 	<ul style="list-style-type: none"> • Place the power supply in a position so that the Pool Cleaner can freely reach all the pool area. • Check that there is enough slack in the floating cable for the Pool Cleaner to reach all of the pool. • Clean the filter basket/canister.
The floating cable has kinks.	<ul style="list-style-type: none"> • Clogged filter basket/canister. • Debris stuck in the impeller-house or impeller-cover. 	<ul style="list-style-type: none"> • Clean the filter basket/canister. • Remove debris stuck in the impeller-house or impeller-cover (according to the drawings). • To remove the kinks, stretch the floating cable out completely and let it sit for at least a day in the sun.
The Pool Cleaner doesn't climb the walls.	<ul style="list-style-type: none"> • Clogged filter basket/canister. • Algae on walls. • Unsuitable pH level. • Debris stuck in the impeller-house or impeller-cover. 	<ul style="list-style-type: none"> • Clean the filter basket/canister. • Check the level of the chemicals of the water. Improper levels may allow the growth of algae making the walls slippery. If so, adjust the levels and scrub the walls. • Remove debris stuck in the impeller-house or impeller-cover (according to the drawings).

Robotic Pool Cleaner Mass 13

8151910