

VEVOR[®]

TOUGH TOOLS, HALF PRICE

Technical Support and E-Warranty Certificate www.vevor.com/support

SWAGE LAG SCREWS

MODEL: YXHF-8102-1/8"-102

YXHF-8102-1/8"-122

We continue to be committed to provide you tools with competitive price.

"Save Half", "Half Price" or any other similar expressions used by us only represents an estimate of savings you might benefit from buying certain tools with us compared to the major top brands and does not necessarily mean to cover all categories of tools offered by us. You are kindly reminded to verify carefully when you are placing an order with us if you are actually saving half in comparison with the top major brands.

VEVOR®

TOUGH TOOLS, HALF PRICE

SWAGE LAG SCREWS

MODEL: YXHF-8102-1/8"-102 YXHF-8102-1/8"-122



<Picture Only For Reference >

NEED HELP? CONTACT US!

Have product questions? Need technical support? Please feel free to contact us: **Technical Support and E-Warranty Certificate**
www.vevor.com/support

This is the original instruction, please read all manual instructions carefully before operating. VEVOR reserves a clear interpretation of our user manual. The appearance of the product shall be subject to the product you received. Please forgive us that we won't inform you again if there are any technology or software updates on our product.

IMPORTANT SAFEGUARDS



WARNING: Read and understand this entire manual before operating or servicing this product. Failure to follow these warnings and instructions can cause personal injury or damage to valuable property.

- 1.The warning indicates that appropriate action should be taken to avoid the potential danger of personal injury.
- 2.Product capabilities apply to properly and completely assembled product only.
- 3.Please keep small spare parts out of children's reach,it is not a toy, Do not allow children to play.
4. For additional information regarding the parts listed in the following pages, please refer to the Assembly Diagram of this manual. Unwrap and separate all parts in a clean work area.

SAVE THESE INSTRUCTIONS

MAIN FEATURUES

This product is mainly used for column installation of wire functions and decorative accessories.

VEVOR's kit is made of all stainless steel materials, which has great resistance to rust and corrosion. It will work for long life time for interior and exterior railings with low maintenance. Please note that it is not recommended for coastal projects.

We work with every effort to provide quality products and professional service, and make VEVOR a reliable brand.

INSTALLATION INSTRUCTION

Installation indication and Applicable post

Only used for the end installation of wooden posts.

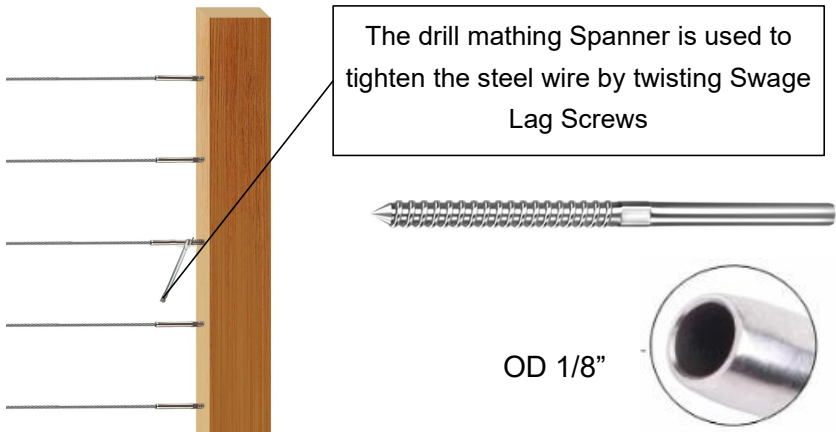

Fitting for wood post



Wire rope size

PRODUCT INFORMATION





Model	D1 (mm)	D2 (mm)	D3 (mm)
YXHF-8102-1/8"-102	ST6.3	3.6	5.5
YXHF-8102-1/8"-122	ST6.3	3.6	5.5

PACKAGE INCLUDE

Model	Qty			Color	
	Swage Lag Screws		Drill		Bent wrench
	R	L			
					
YXHF-8102-1/8"-102	50	50	1	1	silver
YXHF-8102-1/8"-122	60	60	1	1	silver

INSTALLATION

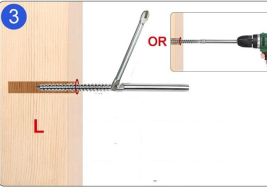
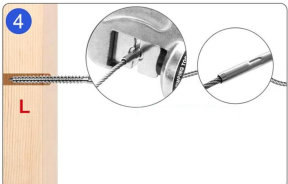
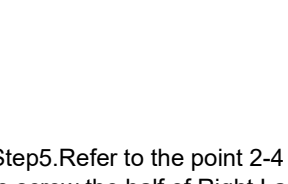
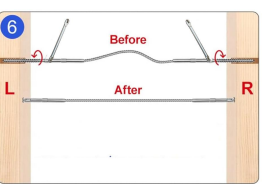
		
<p>Step1.Quick make sure the length of the cable.</p>	<p>Step2.drill holes in the posts to a depth less than1-1/2"</p>	<p>Step3.Use drill mathing Spanner Tool to screw half of the Left Hand Screw Thread into left hand end post about 1" to fix.</p>
		
<p>Step4.Swage lag screws</p>	<p>Step5.Refer to the point 2-4 to screw the half of Right Lag Screw Thread.</p>	<p>Step6.Tighten the cable with the Spanner Tool. Rotate two terminals into the post ends in the same direction at the same time.</p>

Made In China

VEVOR®

TOUGH TOOLS, HALF PRICE

Technical Support and E-Warranty Certificate www.vevor.com/support

VEVOR[®]

TOUGH TOOLS, HALF PRICE

Technique Assistance et certificat de garantie électronique

www.vevor.com/support

VIS TIRE-FOND À SERTIR

MODÈLE: YXHF-8102-1/8"-102

YXHF-8102-1/8"-122

We continue to be committed to provide you tools with competitive price.

"Save Half", "Half Price" or any other similar expressions used by us only represents an estimate of savings you might benefit from buying certain tools with us compared to the major top brands and does not necessarily mean to cover all categories of tools offered by us. You are kindly reminded to verify carefully when you are placing an order with us if you are actually saving half in comparison with the top major brands.

VEVOR®

TOUGH TOOLS, HALF PRICE

SWAGE LAG SCREWS

MODÈLE: YXHF-8102-1/8"-102 YXHF-8102-1/8"-122



< Image uniquement pour référence > _

NEED HELP? CONTACT US!

Have product questions? Need technical support? Please feel free to contact us: **Technical Support and E-Warranty Certificate**
www.vevor.com/support

This is the original instruction, please read all manual instructions carefully before operating. VEVOR reserves a clear interpretation of our user manual. The appearance of the product shall be subject to the product you received. Please forgive us that we won't inform you again if there are any technology or software updates on our product.

GARANTIES IMPORTANTES



AVERTISSEMENT : Lisez et comprenez l'intégralité de ce manuel avant d'utiliser ou d'entretenir ce produit. Le non-respect de ces avertissements et instructions peut entraîner des blessures corporelles ou des dommages à des biens de valeur.

1. L'avertissement indique que des mesures appropriées doivent être prises pour éviter tout risque potentiel de blessure.
2. Les capacités du produit s'appliquent uniquement au produit correctement et complètement assemblé.
3. Veuillez garder les petites pièces de rechange hors de portée des enfants , ce n'est pas un jouet, ne laissez pas les enfants jouer .
- 4 . Pour plus d'informations concernant les pièces répertoriées dans les pages

suivantes, veuillez vous référer au schéma d'assemblage de ce manuel. Déballez et séparez toutes les pièces dans une zone de travail propre.

CONSERVEZ CES INSTRUCTIONS

CARACTÉRISTIQUES PRINCIPALES

Ce produit est principalement utilisé pour l'installation sur colonne de fonctions filaires et d'accessoires décoratifs .

Le kit VEVOR est composé entièrement de matériaux en acier inoxydable, qui présentent une grande résistance à la rouille et à la corrosion. Il fonctionnera pendant une longue durée de vie pour les garde-corps intérieurs et extérieurs nécessitant peu d'entretien. Veuillez noter qu'il n'est pas recommandé pour les projets côtiers.

Nous travaillons avec tous les efforts pour fournir des produits de qualité et un service professionnel, et faire de VEVOR une marque fiable.

INSTRUCTIONS D'INSTALLATION

Indication d'installation et poste applicable

Utilisé uniquement pour l'installation finale de poteaux en bois .

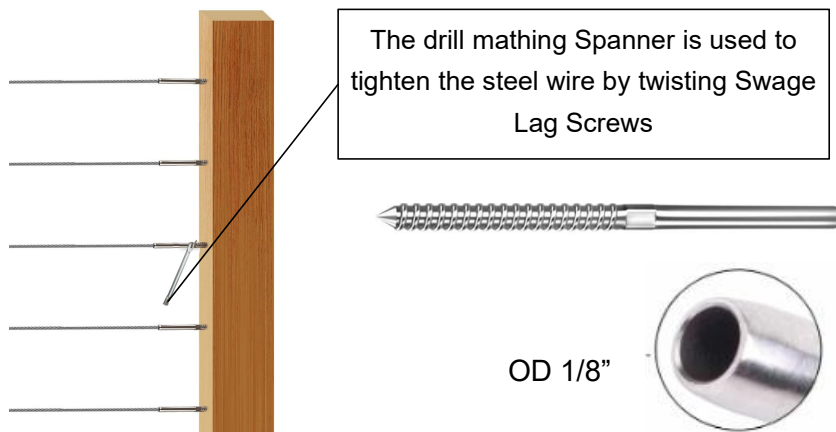

Fixation pour poteau en bois

Taille du câble métallique



INFORMATION PRODUIT





Modèle	D1	D2	D3
--------	----	----	----

	(mm)	(mm)	(mm)
YXHF-8102-1/8"-102	ST6.3	3.6	5.5
YXHF-8102-1/8"-122	ST6.3	3.6	5.5

EMBALLER INCLURE

Modèle	Quantité				Couleur
	Vis tire-fond à sertir		Perçer	Clé pliée	
	R.	L.			
					
YXHF-8102-1/8"-102	50	50	1	1	argent
YXHF-8102-1/8"-122	60	60	1	1	argent

INSTALLATION

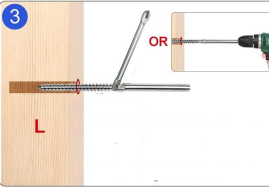
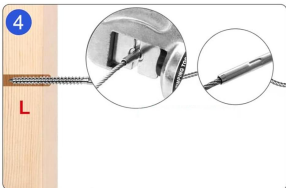
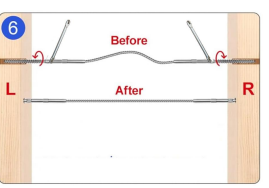
		
<p>Étape 1. Assurez-vous rapidement de la longueur du câble.</p>	<p>Étape 2. Percez des trous dans les poteaux à une profondeur inférieure à 1-1/2"</p>	<p>Étape 3. Utilisez la clé de perçage pour visser la moitié du filetage de vis gauche dans le poteau d'extrémité gauche d'environ 1" pour le fixer.</p>
	<p>Étape 5. Reportez-vous au point 2-4 pour visser la moitié du filetage du tire-fond droit.</p>	
<p>Étape 4. Tire- fond</p>		<p>Étape 6. Serrez le câble avec le Outil clé. Faites pivoter deux terminaux en le message se termine dans la même direction au en même temps.</p>

Fabriqué en Chine

VEVOR®

TOUGH TOOLS, HALF PRICE

Technique Assistance et certificat de garantie électronique
www.vevor.com/support

VEVOR®

TOUGH TOOLS, HALF PRICE

Technisch Support- und E-Garantie-Zertifikat www.vevor.com/support

GESENKSCHRAUBEN

MODELL: YXHF-8102-1/8"-102

YXHF-8102-1/8"-122

We continue to be committed to provide you tools with competitive price.

"Save Half", "Half Price" or any other similar expressions used by us only represents an estimate of savings you might benefit from buying certain tools with us compared to the major top brands and does not necessarily mean to cover all categories of tools offered by us. You are kindly reminded to verify carefully when you are placing an order with us if you are actually saving half in comparison with the top major brands.

VEVOR®

TOUGH TOOLS, HALF PRICE

SWAGE LAG SCREWS

MODELL: YXHF-8102-1/8"-102 YXHF-8102-1/8"-122



< Bild nur als Referenz > _

NEED HELP? CONTACT US!

Have product questions? Need technical support? Please feel free to contact us: **Technical Support and E-Warranty Certificate**
www.vevor.com/support

This is the original instruction, please read all manual instructions carefully before operating. VEVOR reserves a clear interpretation of our user manual. The appearance of the product shall be subject to the product you received. Please forgive us that we won't inform you again if there are any technology or software updates on our product.

WICHTIGE SICHERHEITSMASSNAHMEN



WARNUNG : Lesen und verstehen Sie dieses gesamte Handbuch, bevor Sie dieses Produkt in Betrieb nehmen oder warten. Die Nichtbeachtung dieser Warnungen und Anweisungen kann zu Verletzungen oder Sachschäden führen.

1. Der Warnhinweis weist darauf hin, dass geeignete Maßnahmen ergriffen werden sollten, um die potenzielle Gefahr einer Verletzung zu vermeiden.
2. Die Produkteigenschaften gelten nur für ordnungsgemäß und vollständig montierte Produkte.
3. Bitte bewahren Sie kleine Ersatzteile außerhalb der Reichweite von Kindern auf. Es handelt sich nicht um ein Spielzeug. Lassen Sie Kinder nicht spielen.
4. Weitere Informationen zu den auf den folgenden Seiten aufgeführten Teilen finden Sie im Montagediagramm dieser Anleitung. Packen Sie alle Teile aus und

trennen Sie sie an einem sauberen Arbeitsplatz.

ANLEITUNG AUFBEWAHREN

HAUPTMERKMALE

Dieses Produkt wird hauptsächlich für die Säuleninstallation von Drahtfunktionen und dekorativem Zubehör verwendet .

Das Kit von VEVOR besteht vollständig aus Edelstahlmaterialien, die eine hohe Beständigkeit gegen Rost und Korrosion aufweisen. Es eignet sich für eine lange Lebensdauer von Innen- und Außengeländern bei geringem Wartungsaufwand.

Bitte beachten Sie , dass dies nicht für Küstenprojekte empfohlen wird.

Wir arbeiten mit aller Kraft daran, Qualitätsprodukte und professionellen Service anzubieten und VEVOR zu einer zuverlässigen Marke zu machen.

INSTALLATIONSANWEISUNG

Installationshinweis und anwendbarer Beitrag

Wird nur für die Endmontage von Holzpfosten verwendet .

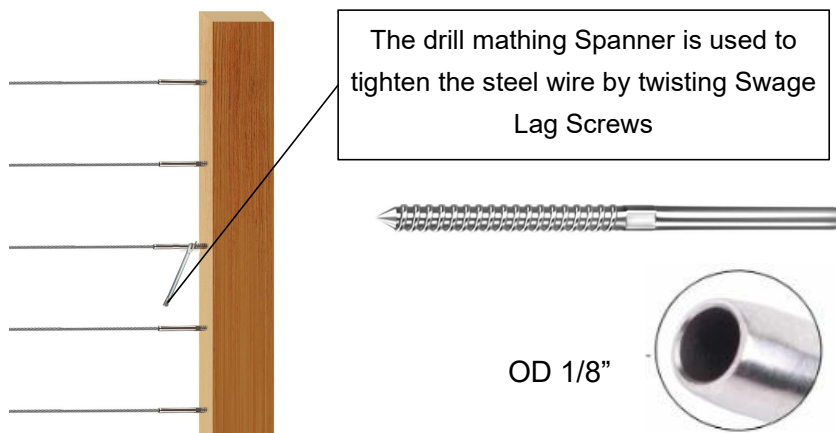

Passend für Holzpfosten

Drahtseilgröße



PRODUKTINFORMATION





Modell	D1 (mm)	D2 (mm)	D3 (mm)
YXHF-8102-1/8"-102	ST6.3	3.6	5.5

YXHF-8102-1/8"-122	ST6.3	3.6	5.5
--------------------	-------	-----	-----

PAKET ENTHALTEN

Modell	Menge				Farbe
	Gesenschrauben		Bohren	Verbogene r Schrauben schlüssel	
	R	L			
					
YXHF-8102-1/8"-102	50	50	1	1	Silber
YXHF-8102-1/8"-122	60	60	1	1	Silber

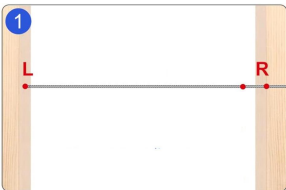
INSTALLATION

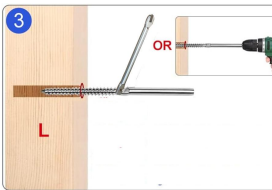
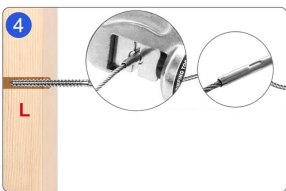
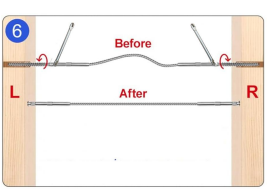
		
<p>Schritt 1: Stellen Sie schnell die Länge des Kabels sicher.</p>	<p>Schritt 2: Bohren Sie Löcher in die Pfosten bis zu einer Tiefe von weniger als 3,8 cm.</p>	<p>Schritt 3: Schrauben Sie mit einem Schraubenschlüssel die Hälfte des linken Schraubengewindes etwa 2,5 cm in den linken Endpfosten, um es zu befestigen.</p>
	<p>Schritt 5. Beziehen Sie sich auf die Punkte 2-4, um die Hälfte des rechten Zugschraubengewindes einzuschrauben.</p>	
<p>Schritt 4. Zugschrauben einpressen</p>		<p>Schritt 6. Ziehen Sie das Kabel mit dem fest Schraubenschlüssel- Werkzeug. Drehen Sie zwei Terminals in Der Beitrag endet in der gleichen Richtung am gleiche Zeit.</p>

In China hergestellt

VEVOR[®]

TOUGH TOOLS, HALF PRICE

Technisch Support- und E-Garantie-Zertifikat www.vevor.com/support

VEVOR®

TOUGH TOOLS, HALF PRICE

Tecnico Supporto e certificato di garanzia elettronica www.vevor.com/support

VITI DA TAGLIO A PRESSARE

MODELLO: YXHF-8102-1/8"-102

YXHF-8102-1/8"-122

We continue to be committed to provide you tools with competitive price.

"Save Half", "Half Price" or any other similar expressions used by us only represents an estimate of savings you might benefit from buying certain tools with us compared to the major top brands and does not necessarily mean to cover all categories of tools offered by us. You are kindly reminded to verify carefully when you are placing an order with us if you are actually saving half in comparison with the top major brands.

VEVOR®

TOUGH TOOLS, HALF PRICE

SWAGE LAG SCREWS

MODELLO: YXHF-8102-1/8"-102 YXHF-8102-1/8"-122



< Immagine solo per riferimento > _

NEED HELP? CONTACT US!

Have product questions? Need technical support? Please feel free to contact us: **Technical Support and E-Warranty Certificate**
www.vevor.com/support

This is the original instruction, please read all manual instructions carefully before operating. VEVOR reserves a clear interpretation of our user manual. The appearance of the product shall be subject to the product you received. Please forgive us that we won't inform you again if there are any technology or software updates on our product.

TUTELA IMPORTANTE



AVVERTENZA : leggere e comprendere l'intero manuale prima di utilizzare o sottoporre a manutenzione questo prodotto. La mancata osservanza di queste avvertenze e istruzioni può causare lesioni personali o danni a beni di valore.

1. L'avvertenza indica che è necessario adottare misure adeguate per evitare il potenziale pericolo di lesioni personali.
2. Le funzionalità del prodotto si applicano solo al prodotto correttamente e completamente assemblato.
3. Si prega di tenere piccoli pezzi di ricambio fuori dalla portata dei bambini , non è un giocattolo, non permettere ai bambini di giocare .
- 4 . Per ulteriori informazioni riguardanti le parti elencate nelle pagine seguenti, fare riferimento allo Schema di Montaggio di questo manuale. Scartare e separare tutte

le parti in un'area di lavoro pulita.

CONSERVA QUESTE ISTRUZIONI

CARATTERISTICHE PRINCIPALI

Questo prodotto viene utilizzato principalmente per l'installazione a colonna di funzioni di filo e accessori decorativi .

Il kit VEVOR è realizzato interamente in acciaio inossidabile, che ha una grande resistenza alla ruggine e alla corrosione. Funzionerà per una lunga durata di ringhiere interne ed esterne con bassa manutenzione. Si tenga presente che non è consigliato per progetti costieri.

Lavoriamo con ogni sforzo per fornire prodotti di qualità e un servizio professionale e rendere VEVOR un marchio affidabile.

ISTRUZIONI PER L'INSTALLAZIONE

Indicazione di installazione e post applicabile

Utilizzato solo per l'installazione finale dei pali in legno .

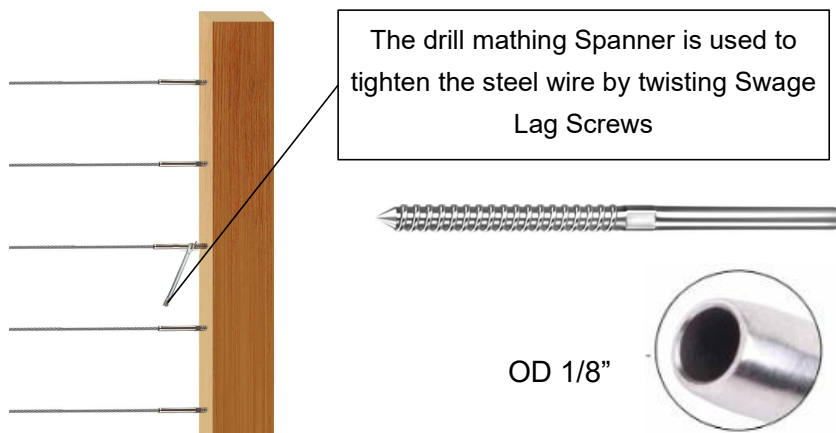

Raccordo per palo in legno
metallica

Dimensioni della fune



INFORMAZIONI SUL PRODOTTO



Modello	D1 (mm)	D2 (mm)	D3 (mm)

YXHF-8102-1/8"-102	ST6.3	3.6	5.5
YXHF-8102-1/8"-122	ST6.3	3.6	5.5

PACCHETTO INCLUDERE

Modello	Qtà				Color e
	Viti da taglio a pressare		Trapano	Chiave piegata	
	R	I			
					
YXHF-8102-1/8"-102	50	50	1	1	argento
YXHF-8102-1/8"-122	60	60	1	1	argento

INSTALLAZIONE

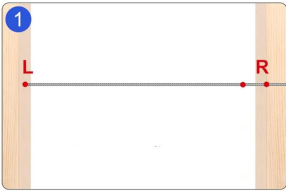
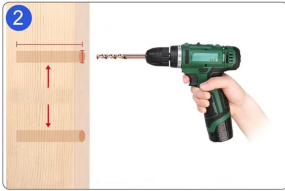
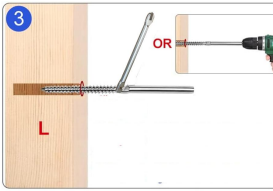
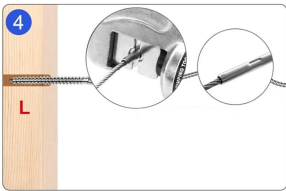
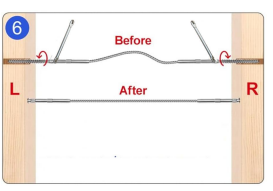
		
<p>Passo 1. Assicurarsi rapidamente della lunghezza del cavo.</p>	<p>Passaggio 2. Praticare dei fori nei montanti a una profondità inferiore a 1-1/2"</p>	<p>Passaggio 3. Utilizzare lo strumento chiave per trapano per avvitare metà della filettatura della vite sinistra nel montante sinistro per circa 1 pollice per fissarla.</p>
	<p>Passaggio 5. Fare riferimento al punto 2-4 per avvitare la metà della filettatura della vite interframmentaria destra.</p>	
<p>Step4. Swage viti da taglio</p>		<p>Passaggio 6. Stringere il cavo con il Strumento chiave inglese. Ruotare due terminali in il post termina nella stessa direzione al contemporaneamente.</p>

Made in China

VEVOR[®]

TOUGH TOOLS, HALF PRICE

Tecnico Supporto e certificato di garanzia elettronica

www.vevor.com/support

VEVOR®

TOUGH TOOLS, HALF PRICE

Técnico Soporte y certificado de garantía electrónica www.vevor.com/support

TIRAFONDOS ESTAMPADOS

MODELO: YXHF-8102-1/8"-102

YXHF-8102-1/8"-122

We continue to be committed to provide you tools with competitive price.

"Save Half", "Half Price" or any other similar expressions used by us only represents an estimate of savings you might benefit from buying certain tools with us compared to the major top brands and does not necessarily mean to cover all categories of tools offered by us. You are kindly reminded to verify carefully when you are placing an order with us if you are actually saving half in comparison with the top major brands.

VEVOR®

TOUGH TOOLS, HALF PRICE

SWAGE LAG SCREWS

MODELO: YXHF-8102-1/8"-102 YXHF-8102-1/8"-122



< Imagen sólo como referencia > _

NEED HELP? CONTACT US!

Have product questions? Need technical support? Please feel free to contact us: **Technical Support and E-Warranty Certificate**
www.vevor.com/support

This is the original instruction, please read all manual instructions carefully before operating. VEVOR reserves a clear interpretation of our user manual. The appearance of the product shall be subject to the product you received. Please forgive us that we won't inform you again if there are any technology or software updates on our product.

CONSIDERACIONES IMPORTANTES



ADVERTENCIA : Lea y comprenda este manual completo antes de operar o reparar este producto. El incumplimiento de estas advertencias e instrucciones puede provocar lesiones personales o daños a bienes valiosos.

1. La advertencia indica que se deben tomar las medidas adecuadas para evitar el peligro potencial de lesiones personales.
2. Las capacidades del producto se aplican únicamente al producto ensamblado de manera adecuada y completa.
3. Mantenga las piezas de repuesto pequeñas fuera del alcance de los niños , no es un juguete, no permita que los niños jueguen .
- 4 . Para obtener información adicional sobre las piezas enumeradas en las siguientes páginas, consulte el diagrama de montaje de este manual.

Desenvuelva y separe todas las piezas en un área de trabajo limpia.

GUARDA ESTAS INSTRUCCIONES

CARACTERÍSTICAS PRINCIPALES

Este producto se utiliza principalmente para la instalación en columnas de funciones de alambre y accesorios decorativos .

El kit de VEVOR está fabricado íntegramente con materiales de acero inoxidable, que tiene una gran resistencia al óxido y la corrosión. Funcionará durante una larga vida útil para barandillas interiores y exteriores con bajo mantenimiento.

Tenga en cuenta que no se recomienda para proyectos costeros.

Trabajamos con todo el esfuerzo para brindar productos de calidad y un servicio profesional, y hacer de VEVOR una marca confiable.

INSTRUCCIONES DE INSTALACIÓN

Indicación de instalación y publicación aplicable

Sólo se utiliza para la instalación final de postes de madera .

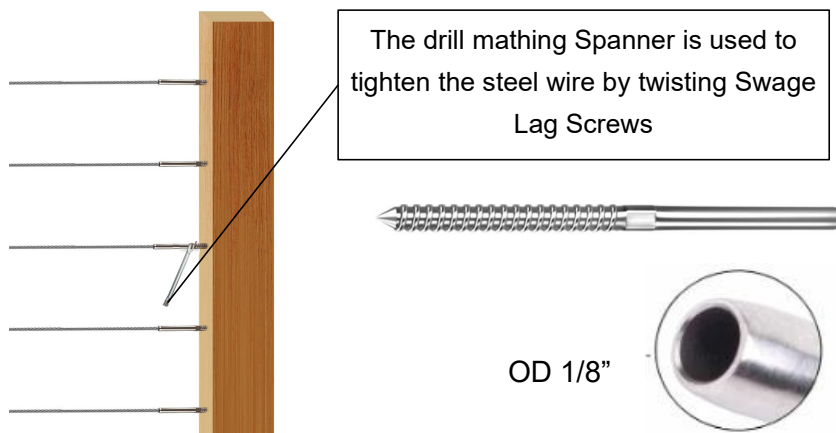

Accesorio para poste de madera

Tamaño del cable

INFORMACIÓN DEL PRODUCTO





Modelo	D1 (mm)	D2 (mm)	D3 (mm)
YXHF-8102-1/8"-102	ST6.3	3.6	5.5

YXHF-8102-1/8"-122	ST6.3	3.6	5.5
--------------------	-------	-----	-----

PAQUETE INCLUIR

Modelo	Cantidad				Color
	Tirafondos estampados		Perforar	llave doblada	
	R	I			
					
YXHF-8102-1/8"-102	50	50	1	1	plata
YXHF-8102-1/8"-122	60	60	1	1	plata

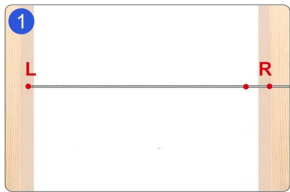
INSTALACIÓN

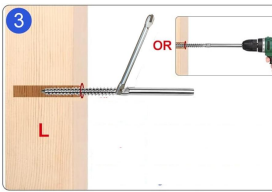
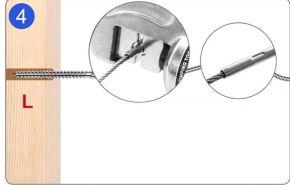
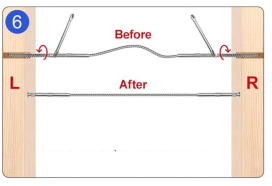
		
<p>Paso 1. Asegúrese rápidamente de la longitud del cable.</p>	<p>Paso 2. Taladre agujeros en los postes a una profundidad inferior a 1-1/2"</p>	<p>Paso 3. Utilice la herramienta de llave inglesa para atornillar la mitad de la rosca del tornillo izquierdo en el poste del extremo izquierdo aproximadamente 1" para fijar.</p>
	<p>Paso 5. Consulte el punto 2-4 para atornillar la mitad de la rosca del tirafondo derecho.</p>	
<p>Paso 4. Tirafondos estampados</p>		<p>Paso 6. Apriete el cable con el Herramienta llave inglesa. Gire dos terminales hacia el poste termina en la misma dirección en el Mismo tiempo.</p>

Hecho en china

VEVOR[®]

TOUGH TOOLS, HALF PRICE

Técnico Soporte y certificado de garantía electrónica

www.vevor.com/support

VEVOR®

TOUGH TOOLS, HALF PRICE

Techniczny Certyfikat wsparcia i e-gwarancji www.vevor.com/support

ŚRUBY DOCISKOWE

MODEL: YXHF-8102-1/8"-102

YXHF-8102-1/8"-122

We continue to be committed to provide you tools with competitive price.

"Save Half", "Half Price" or any other similar expressions used by us only represents an estimate of savings you might benefit from buying certain tools with us compared to the major top brands and does not necessarily mean to cover all categories of tools offered by us. You are kindly reminded to verify carefully when you are placing an order with us if you are actually saving half in comparison with the top major brands.

VEVOR®

TOUGH TOOLS, HALF PRICE

SWAGE LAG SCREWS

MODEL: YXHF-8102-1/8"-102 YXHF-8102-1/8"-122



< Zdjęcie wyłącznie w celach informacyjnych >

NEED HELP? CONTACT US!

Have product questions? Need technical support? Please feel free to contact us: **Technical Support and E-Warranty Certificate**
www.vevor.com/support

This is the original instruction, please read all manual instructions carefully before operating. VEVOR reserves a clear interpretation of our user manual. The appearance of the product shall be subject to the product you received. Please forgive us that we won't inform you again if there are any technology or software updates on our product.

WAŻNI OCHRONIARZE



OSTRZEŻENIE : Przed przystąpieniem do obsługi lub serwisowania tego produktu należy przeczytać i zrozumieć całą niniejszą instrukcję. Niezastosowanie się do tych ostrzeżeń i instrukcji może spowodować obrażenia ciała lub uszkodzenie cennego mienia.

1. Ostrzeżenie wskazuje, że należy podjąć odpowiednie działania, aby uniknąć potencjalnego niebezpieczeństwa obrażeń ciała.
2. Możliwości produktu dotyczą wyłącznie prawidłowo i całkowicie zmontowanego produktu.
3. Małe części zamienne należy trzymać poza zasięgiem dzieci . To nie jest zabawka. Nie pozwalaj dzieciom na zabawę .
- 4 . Dodatkowe informacje dotyczące części wymienionych na kolejnych stronach można znaleźć w schemacie montażu w niniejszej instrukcji. Rozpakuj i oddziel

wszystkie części w czystym miejscu pracy.

ZACHOWAJ TE INSTRUKCJE

GLÓWNE CECHY

Ten produkt jest używany głównie do montażu kolumn z funkcjami drutowymi i akcesoriami dekoracyjnymi .

Zestaw VEVOR wykonany jest w całości ze stali nierdzewnej, która charakteryzuje się dużą odpornością na rdzę i korozję . Będzie działać przez długi czas w przypadku balustrad wewnętrznych i zewnętrznych przy niewielkich wymaganiach konserwacyjnych. Należy pamiętać , że nie jest on zalecany do projektów przybrzeżnych.

Dokładamy wszelkich starań, aby zapewnić wysoką jakość produktów i profesjonalną obsługę oraz sprawić, że VEVOR będzie niezawodną marką.

INSTRUKCJA INSTALACJI

Wskazanie instalacji i odpowiedni słupek

Stosowany wyłącznie do końcowego montażu słupków drewnianych .

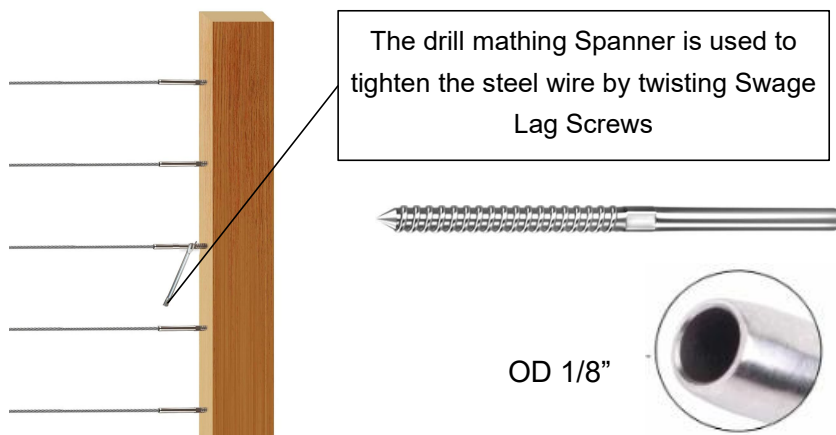

Pasowanie do słupka drewnianego

Rozmiar liny

stalowej



INFORMACJE O PRODUKCIE





Model	D1	D2	D3
-------	----	----	----

	(mm)	(mm)	(mm)
YXHF-8102-1/8"-102	ST6.3	3.6	5.5
YXHF-8102-1/8"-122	ST6.3	3.6	5.5

PAKIET WŁĄCZĄĆ

Model	Ilość				Kolor
	Śruby dociskowe		Wiertark	Wygięty klucz	
	R	L	a		
					
YXHF-8102-1/8"-102	50	50	1	1	srebro
YXHF-8102-1/8"-122	60	60	1	1	srebro

INSTALACJA

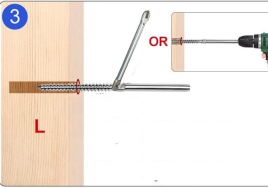
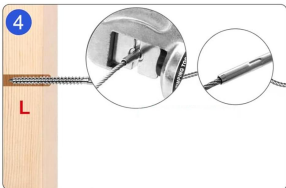
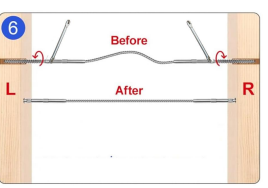
		
<p>Krok 1. Szybko sprawdź długość kabla.</p>	<p>Krok 2. wywierć otwory w słupkach na głębokość mniejszą niż 1-1/2"</p>	<p>Krok 3. Za pomocą narzędzia do wiercenia wkręć połowę lewego gwintu w lewy słupek końcowy na głębokość około 1 cala, aby go zamocować.</p>
	<p>Krok 5. Przejdź do punktu 2-4, aby przykręcić połowę prawego gwintu.</p>	
<p>Krok 4. Śruby dociskowe</p>		<p>Krok 6. Dokręć kabel za pomocą Narzędzie klucza. Obróć dwa zaciski do post kończy się w tym samym kierunku na w tym samym czasie.</p>

Wyprodukowano w Chinach

VEVOR®

TOUGH TOOLS, HALF PRICE

VEVOR[®]

TOUGH TOOLS, HALF PRICE

Technisch Ondersteuning en e-garantiecertificaat www.vevor.com/support

SWAGE LAG-SCHROEVEN

MODEL: YXHF-8102-1/8"-102

YXHF-8102-1/8"-122

We continue to be committed to provide you tools with competitive price.

"Save Half", "Half Price" or any other similar expressions used by us only represents an estimate of savings you might benefit from buying certain tools with us compared to the major top brands and does not necessarily mean to cover all categories of tools offered by us. You are kindly reminded to verify carefully when you are placing an order with us if you are actually saving half in comparison with the top major brands.

VEVOR®

TOUGH TOOLS, HALF PRICE

SWAGE LAG SCREWS

MODEL: YXHF-8102-1/8"-102 YXHF-8102-1/8"-122



< Afbeelding alleen ter referentie > _

NEED HELP? CONTACT US!

Have product questions? Need technical support? Please feel free to contact us: **Technical Support and E-Warranty Certificate**
www.vevor.com/support

This is the original instruction, please read all manual instructions carefully before operating. VEVOR reserves a clear interpretation of our user manual. The appearance of the product shall be subject to the product you received. Please forgive us that we won't inform you again if there are any technology or software updates on our product.

BELANGRIJKE VEILIGHEIDSMATREGELEN



WAARSCHUWING : Lees en begrijp deze gehele handleiding voordat u dit product bedient of onderhoudt. Het niet opvolgen van deze waarschuwingen en instructies kan persoonlijk letsel of schade aan waardevolle eigendommen veroorzaken.

1. De waarschuwing geeft aan dat passende maatregelen moeten worden genomen om het potentiële gevaar van persoonlijk letsel te voorkomen.
2. Productmogelijkheden zijn alleen van toepassing op correct en volledig gemonteerde producten.
3. Bewaar kleine reserveonderdelen buiten het bereik van kinderen . Het is geen speelgoed. Laat kinderen niet spelen .
- 4 . Voor aanvullende informatie over de onderdelen die op de volgende pagina's worden vermeld, verwijzen wij u naar het montageschema van deze handleiding.

Pak alle onderdelen uit en scheid ze van elkaar op een schone werkplek.

BEWAAR DEZE INSTRUCTIES

BELANGRIJKSTE KENMERKEN

Dit product wordt voornamelijk gebruikt voor kolominstallatie van draadfuncties en decoratieve accessoires .

De kit van VEVOR is gemaakt van volledig roestvrijstalen materialen, die een grote weerstand hebben tegen roest en corrosie. Het zal een lange levensduur hebben voor binnen- en buitenleuningingen met weinig onderhoud. Houd er rekening mee dat dit niet wordt aanbevolen voor kustprojecten.

We doen er alles aan om kwaliteitsproducten en professionele service te leveren, en maken van VEVOR een betrouwbaar merk.

INSTALLATIE INSTRUCTIE

Installatie-indicatie en toepasselijke post

Wordt alleen gebruikt voor de eindmontage van houten palen .

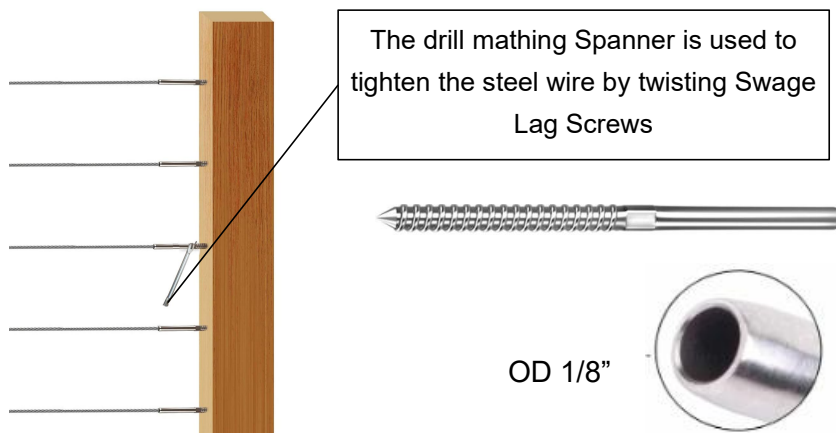

Passend voor houten paal

Afmeting draadkabel



PRODUCTINFORMATIE





Model	D1 (mm)	D2 (mm)	D3 (mm)
YXHF-8102-1/8"-102	ST6.3	3.6	5.5

YXHF-8102-1/8"-122	ST6.3	3.6	5.5
--------------------	-------	-----	-----

PAKKET ERBIJ BETREKKEN

Model	Aantal			Kleur	
	Swage Lag-schroeven		Oefening		Gebogen sleutel
	R	L			
					
YXHF-8102-1/8"-102	50	50	1	1	zilver
YXHF-8102-1/8"-122	60	60	1	1	zilver

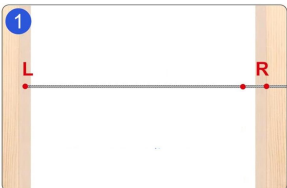
INSTALLATIE

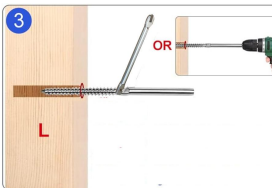
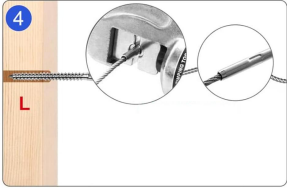
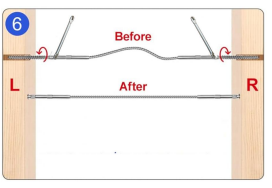
		
<p>Stap 1. Controleer snel de lengte van de kabel.</p>	<p>Stap 2. Boor gaten in de palen tot een diepte van minder dan 1-1/2 "</p>	<p>Stap 3. Gebruik het boorwiskundig gereedschap om de helft van de linker schroefdraad ongeveer 1 "in de linker eindstijl te schroeven om deze te bevestigen.</p>
	<p>Stap 5. Raadpleeg punt 2-4 om de helft van de rechtse schroefdraad te schroeven.</p>	
<p>Step4. Swage lag-schroeven</p>		<p>Stap6. Draai de kabel vast met de Sleutel gereedschap. Draai twee terminals in de paal eindigt in dezelfde richting bij de dezelfde tijd.</p>

Gemaakt in China

VEVOR[®]

TOUGH TOOLS, HALF PRICE

Technisch Ondersteuning en e-garantiecertificaat www.vevor.com/support

VEVOR[®]

TOUGH TOOLS, HALF PRICE

Teknisk Support och e-garanticertifikat www.vevor.com/support

SWAGE LAG SKRUVAR

MODELL: YXHF-8102-1/8"-102

YXHF-8102-1/8"-122

We continue to be committed to provide you tools with competitive price.

"Save Half", "Half Price" or any other similar expressions used by us only represents an estimate of savings you might benefit from buying certain tools with us compared to the major top brands and does not necessarily mean to cover all categories of tools offered by us. You are kindly reminded to verify carefully when you are placing an order with us if you are actually saving half in comparison with the top major brands.

VEVOR®

TOUGH TOOLS, HALF PRICE

SWAGE LAG SCREWS

MODELL: YXHF-8102-1/8"-102 YXHF-8102-1/8"-122



< Endast bild för referens > _

NEED HELP? CONTACT US!

Have product questions? Need technical support? Please feel free to contact us: **Technical Support and E-Warranty Certificate**
www.vevor.com/support

This is the original instruction, please read all manual instructions carefully before operating. VEVOR reserves a clear interpretation of our user manual. The appearance of the product shall be subject to the product you received. Please forgive us that we won't inform you again if there are any technology or software updates on our product.

VIKTIGA SÄKERHETSÅTGÄRDER



WARNING : Läs och förstå hela denna manual innan du använder eller servar denna produkt. Underlåtenhet att följa dessa varningar och instruktioner kan orsaka personskada eller skada på värdefull egendom.

1. Varningen anger att lämpliga åtgärder bör vidtas för att undvika den potentiella faran för personskada.
2. Produktegenskaper gäller endast för korrekt och fullständigt monterad produkt.
3. Förvara små reservdelar utom räckhåll för barn, det är inte en leksak, låt inte barn leka .
- 4 . För ytterligare information om delarna som listas på följande sidor, se monteringsdiagrammet i denna manual. Packa upp och separera alla delar på ett rent arbetsområde.

SPARA DESSA INSTRUKTIONER

HUVUDFUNKTIONER

Denna produkt används huvudsakligen för pelarinstallation av trådfunktioner och dekorativa tillbehör .

VEVORs kit är tillverkat av alla material i rostfritt stål, vilket har stor motståndskraft mot rost och korrosion . Det kommer att fungera för lång livslängd för inre och yttre räckan med lågt underhåll. Observera att det inte rekommenderas för kustprojekt . Vi arbetar med alla ansträngningar för att tillhandahålla kvalitetsprodukter och professionell service, och göra VEVOR till ett pålitligt varumärke.

INSTALLATIONSANVISNING

Installationsindikation och tillämplig stolpe

Används endast för slutmontage av trästolpar .

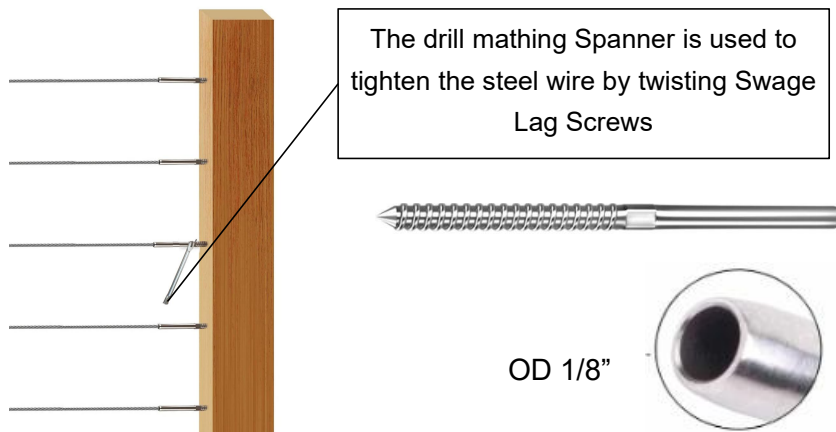

Passar till trästolpe

Vajerstorlek

PRODUKTINFORMATION



Modell	D1 (mm)	D2 (mm)	D3 (mm)
YXHF-8102-1/8"-102	ST6.3	3.6	5.5
YXHF-8102-1/8"-122	ST6.3	3.6	5.5

PAKET OMFATTA

Modell	Antal				Färg
	Swage Lag Skruvar		Borra	Böjd skiftnyckel	
	R	L			
YXHF-8102-1/8"-102	50	50	1	1	silver
YXHF-8102-1/8"-122	60	60	1	1	silver

INSTALLATION

<p>Steg 1. Snabb kontrollera längden på kabeln.</p>	<p>Steg 2. borra hål i stolparna till ett djup som är mindre än 1-1/2"</p>	<p>Steg 3. Använd borrhnyckelverktyget för att skruva hälften av den vänstra skruvgängan i den vänstra ändstolpen cirka 1" för att fixera.</p>
	<p>Steg 5. Se punkt 2-4 för att skruva hälften av höger lagskruvgänga.</p>	
<p>Steg 4. Swage lag skruvar</p>		<p>Steg 6. Dra åt kabeln med Nyckelverktyg. Vrid två terminaler in i stolpen slutar i samma riktning vid samma tid.</p>

Tillverkad i Kina

VEVOR®

TOUGH TOOLS, HALF PRICE

Teknisk Support och e-garanticertifikat www.vevor.com/support