

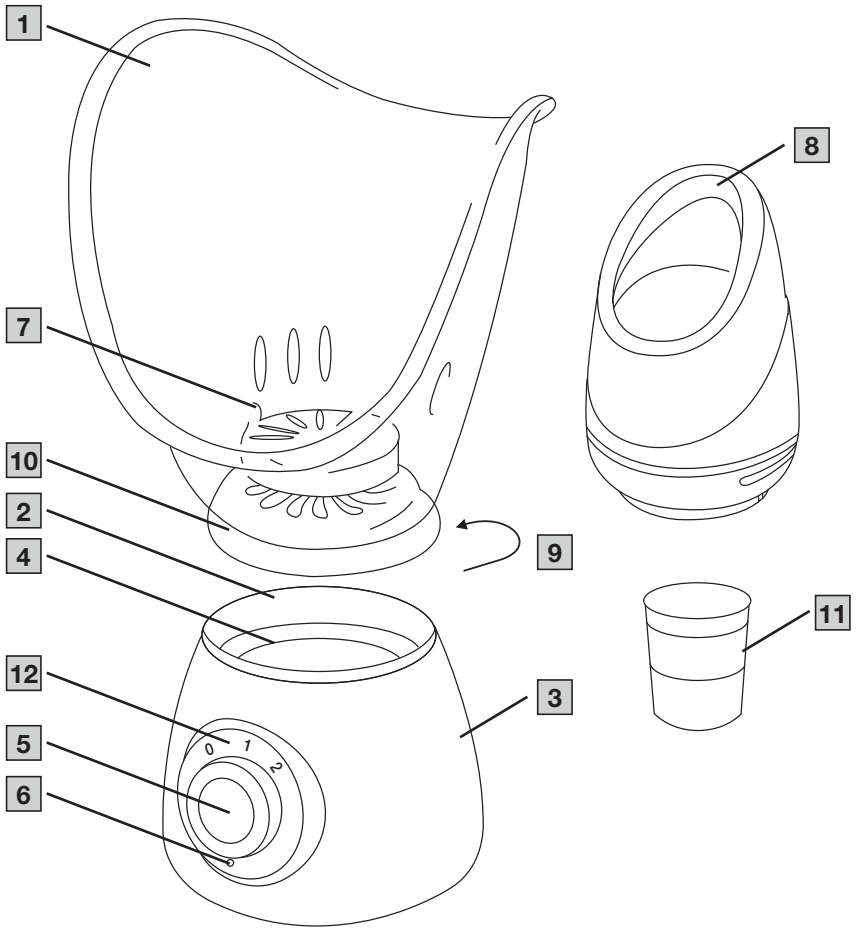

EN Facial sauna
Instructions for use





Read these instructions for use carefully. Observe the warnings and safety notes. Keep these instructions for use for future reference. Make the instructions for use accessible to other users. If the device is passed on, provide the instructions for use to the next user as well.

⚠ WARNING

- The device is only intended for domestic/private use, not for commercial use.
- This device may be used by children over the age of 8 and by people with reduced physical, sensory or mental skills or a lack of experience or knowledge, provided that they are supervised or have been instructed on how to use the device safely, and are fully aware of the consequent risks of use.
- Children must not play with the device.
- Cleaning and user maintenance must not be performed by children unless supervised.
- If the mains connection cable of this device is damaged, it must be disposed of. If it cannot be removed, the device must be disposed of.
- Always ensure that the device is securely positioned on a level surface. Risk of scalding through escaping liquids.
- Warning – the escaping steam is very hot!
- Under no circumstances should you open or repair the device yourself, as faultless functionality can no longer be guaranteed thereafter. Failure to adhere to this instruction will void the warranty.

Table of contents

1. Included in delivery	4	7.1 Using the facial sauna	5
2. Signs and symbols	4	7.2 Use of medicinal herbs, oils and other aromatic substances	5
3. Warnings and safety notes	4	7.3 Using the nose/mouth steam mask	5
4. Intended use	4	8. Cleaning and maintenance	6
4.1 Important instructions during use	4	9. Disposal	6
4.2 Important instructions for after use	5	10. Technical data	6
5. Device description	5	11. Warranty	6
6. Initial use	5		
7. Use	5		



1. INCLUDED IN DELIVERY















Check that the device packaging has not been tampered with and make sure that all contents are present. Before use, ensure that there is no visible damage to the device or accessories and that all packaging material has been removed. If you have any doubts, do not use the device and contact your retailer or the specified Customer Services address.

- 1 x Facial sauna
- 2 x Attachments
- 1 x Measuring jug
- 1 x Instructions for use

2. SIGNS AND SYMBOLS

The following symbols are used on the device, in these instructions for use, on the packaging and on the type plate for the device:

	WARNING
Indicates a potentially impending danger. If it is not avoided, death or serious injury will occur.	
	CAUTION
Indicates a potentially impending danger. If it is not avoided, slight or minor injuries may occur.	
	NOTICE
Indicates a potentially harmful situation. If it is not avoided, the system or something in its vicinity may be damaged.	

	Caution, hot surface
	CE labelling This product satisfies the requirements of the applicable European and national directives.
	The electronic device must not be disposed of with household waste
	Manufacturer
	Protection class II
 	Do not keep your face too close to the mask as otherwise burns can occur because of the hot steam.
	Read the instructions for use
	The products demonstrably meet the requirements of the Technical Regulations of the EAEU.
	Marking to identify the packaging material. A = Material code, B = Material number: 1-7 = Plastics, 20-22 = Paper and cardboard
 	Separate the product and packaging elements and dispose of them in accordance with local regulations.
	Importer symbol
	United Kingdom Conformity Assessed Mark

3. WARNINGS AND SAFETY NOTES

⚠ WARNING

- If using the device in the bathroom, unplug it after use - this is because proximity to water constitutes a danger even when the hair dryer is switched off.
- As an additional safety measure, the installation in the bathroom circuit of a residual current device (FI/RCD) with a rated tripping current not exceeding 30 mA is recommended. Ask your installer for advice.
- The device is intended only for the purpose described in the instructions for use. The manufacturer cannot be held responsible for damage arising from incorrect or careless use. This device is not suitable for commercial or medical use, but is only intended for private domestic use.
- Repairs must be carried out only by authorised service agents as special tools and special parts are required for repair. Otherwise the guarantee is void.
- Do not use the device if you suffer from heart disease, skin flushing, inflammation, swelling, sensitive areas, diabetes, wounds, burns, eczema or psoriasis.
- During pregnancy or if you have health problems, consult your doctor before using the device.
- Children do not recognise the dangers that can arise in conjunction with electrical devices. Ensure that the device cannot be used by children unsupervised.
- Check before you plug the device into the mains that the local voltage is the same as the voltage given on the device.
- Do not use the device in the vicinity of water (e.g. bath tub, wash basin, etc.).
- Do not use the device in the bath or shower or when you are asleep.
- Do not put it in water or other liquids. Keep the device in a safe place.
- Do not place the device on water-sensitive surfaces.
- Use the device only with the facial sauna steam mask attached.
- Keep the device and mains cable away from hot surfaces.

4. INTENDED USE

4.1 Important instructions during use

⚠ WARNING

- Switch off the device immediately if a fault occurs during use and unplug it from the socket.
- Do not keep your face too close to the mask as otherwise burns can occur because of the hot steam. Close your eyes during use and protect heat-sensitive areas.
- Do not use the device for longer than 20 minutes.
- Stop using it with oils and herbs if skin irritation or anything else unusual occurs in the skin.
- You should also stop using it if you develop pain or feel unwell and you should consult your doctor.
- Do not use the device under covers, towels etc.
- Do not change the accessories while in use as there is a risk of burns if hot liquids spill.
- **Caution:** The overheating protection switches the device off after approx. 2 minute if the water in the water container has run dry.
- The device can be started again as normal after a cooling down period of approx. 6 minutes.
- If the device falls into water by accident, unplug it immediately. Have the device checked by a qualified electrician before using it again.

4.2 Important instructions for after use

▲ IMPORTANT

- After use, switch off the device and unplug it.
- Never unplug it with wet hands or by pulling on the cable.
- Empty any remaining liquid from the side of the vaporizer. Ensure that no liquids can get into the device through the switch, the cable or the bottom of the device.
- The device should be cleaned after use to avoid the collection of grease and other residues. This ensures optimal operation and prolongs the working life of the device.
- Let the device cool down fully before operating it again.
- If you have any further questions about using our devices, please consult your dealer or the Customer Service department.

5. DEVICE DESCRIPTION

- 1 Facial sauna steam mask for the entire face
- 2 Water container
- 3 Basic unit
- 4 Maximum filling level
- 5 Rotary switch
- 6 Indicator light
- 7 Aroma attachment
- 8 Facial sauna steam mask for nose and mouth
- 9 Steam valve (reverse)
- 10 Steam disc
- 11 Measuring cup
- 12 Output levels

6. INITIAL USE

Uncoil the cable fully. Place the device on a flat, firm, level and water-insensitive surface or on a table.

Use the measuring cup to fill the device's water container with water. Do not exceed the **maximum** filling level.

You should never fill the container directly under running water but only use the measuring cup that comes with it. The water volume at maximum filling level is enough for about 20 minutes use. Do not use oils, herbs or other aromatic substances as a substitute for water but only added to adequate water filling.

As well as the facial mask, there is also a special attachment for the nose.

Fix the desired steam mask onto the basic unit by turning it. Ensure that the mask engages firmly with the knobs.

7. USE

This device is intended only for use on the human face.

Using the facial sauna provides an ideal basis for cosmetic facial care. The skin of your face is prepared optimally for further treatments such as deep cleansing, moisturising, face masks etc. Beauty salons very often begin facial treatments with a steam treatment. The invigorating steam increases the skin circulation, the pores are opened and impurities are removed more easily. You can thus provide the perfect basis for every kind of facial care. The skincare products penetrate deep into the skin through the opened pores, thus optimising their action.

7.1 Using the facial sauna

Plug into the socket. Then turn the control clockwise until the blue check lamp lights up. Turn the switch first to position "2" in order to speed up heating. After about 3 minutes, steam begins to rise. Turn the switch back to position "1" to reduce the steam output.

Adjustable steam outlet:

You can also regulate the strength of the steam outlet by turning the steam disc.

When the steam outlet is closed, the steam comes out of the steam valve which is located on the back of the device or mask. The water heating phase can also be shortened by closing the steam disc.

To avoid burns, never touch the steam outlet directly and ensure that the steam can come out of the valve freely.

Now sit down in front of the device. Bend forward until your face is above the mask.

▲ WARNING

Do not hold the device in your hand and do not adjust it during operation until it has cooled down. You could sustain burn injuries from hot water.

If the steam effect is perceived as too hot, increase the distance to avoid burns.

▲ WARNING

The exiting steam is hot!

During the treatment, you should always turn the switch back to position "1".

Do not position your face too close to the mask, as otherwise the high intensity of the steam can cause burns or redness.

When you want to stop using the device or the water has evaporated, turn the switch back to position "0". The device's indicator goes out.

Rinse your face with cold water after use. Then apply a face cream or mask. The opened pores let the active ingredients penetrate deep into the skin.

Do not use the facial sauna for more than 20 minutes per day. Using it 2-3 times a week is recommended.

7.2 Use of medicinal herbs, oils and other aromatic substances

The aroma attachment enables you to use medicinal herbs, oils and other aromatic substances as part of an aromatherapy treatment. This is the best way for medicinal herbs, oils and other aromatic substances that mix with the steam to exert their effect. However, no solutions containing salt should be used.

Only use medicinal herbs, oils and other aromatic substances that are intended and suitable for use with a steam mask and are licensed for this by the producer of these substances.

Use:

Open the lid of the aroma attachment. Put a few drops of the oil on a cotton wool ball. Put in the cotton wool ball and then close the aroma attachment.

Important: Please do not fill fragrances directly in the water containers; this may cause a fault in the device. Failure to comply will result in voiding of the warranty.

7.3 Using the nose/mouth steam mask

As the mucous membrane of the human nose is very sensitive, never use the device on position "2" when using with the nose/mouth steam mask. Do not keep your nose too close to the mask during use.

The treatment should not last more than 10 minutes per day and should be done 2-3 times a week at the most.

Use as described under 6.1.

8. CLEANING AND MAINTENANCE

Unplug the device. Let it cool for about 10–15 minutes before taking the steam mask off the basic unit by turning it anticlockwise. Empty the water container by holding it upside down.

Clean grease and chalk deposits after each use with a commercially available decalcification agent suitable for aluminium. Use a soft and slightly moistened cloth to clean the surface of the device and the steam mask and then wipe the surface dry.

- Do not use harsh agents (e.g. alcohol, acetone, benzine or abrasives) to clean the plastic parts.
- Do not use any sharp or pointed objects for cleaning.
- Do not immerse the device in water.

9. DISPOSAL

For environmental reasons, do not dispose of the device in household waste at the end of its service life. Dispose of the device at a suitable local collection or recycling point in your country. Observe the local regulations for material disposal. Dispose of the device in accordance with EC Directive – WEEE (Waste Electrical and Electronic Equipment).

If you have any questions, please contact the local authorities responsible for waste disposal.

You can obtain the location of collection points for old devices from the local or municipal authorities, local waste disposal company or your dealer, for example.



10. TECHNICAL DATA

Mains connection	230-240 V~; 50-60 Hz; 120 W
------------------	-----------------------------

Dimensions	19.5 x 18.0 x 30 cm
------------	---------------------

Weight	approx. 648 g
--------	---------------

Subject to technical changes.

11. WARRANTY

Further information on the warranty and warranty conditions can be found in the warranty leaflet supplied.

