

ROYAL 53S INTEK

Operator's Manual

Read the operator's manual carefully and make sure that you understand the contents before using the lawnmower.

Manual del operador





Lea el manual del operador con atención y asegúrese de que comprende el contenido antes de utilizar el cortacésped.

WARNING: Engine exhaust, some of its constituents, and certain vehicle components contain or emit chemicals known to the State of California to cause cancer and birth defects or other reproductive harm.

AVISO: El Estado de California tiene conocimiento de que los humos del escape del motor, algunos de sus constituyentes, y ciertos componentes del vehículo pueden causar cáncer, defectos de nacimiento y otros daños de reproducción.

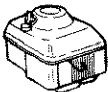
5119477-01

Technical data
Especificaciones técnicas

		ROYAL 53S INTEK
ENGINE		Briggs & Stratton Intek Edge OHV 6.75
GROUND SPEED		1.2 - 3.4 m.p.h
WEIGHT		122 lbs
WIDTH		21 inches
HEIGHT SETTINGS		0.7 - 3.3 inches

IMPORTANT! Read operating instructions carefully before using the mower. Fill the engine with oil. **The manufacturer reserves the right to carry out product modifications without further notice.**

IMPORTANTE! Es muy importante que Vd. lea estas instrucciones con mucha atención antes de estrenar el cortacésped. **El fabricante se reserva el derecho de poder cambiar los productos sin aviso previo.**

CARTON CONTENTS

CONTENIDO DE LA CAJA

1. Powerdrive Lever
2. Operator Presence Control
3. Handle Assembly
4. Grass Catcher
5. Bottle of oil
6. Instruction Manual
7. Rating Label
8. Warning Label
9. Mulching Plug

1. Palanca de cambios
2. Estribo de seguridad
3. Conjunto del mango
4. Recogedor
5. Botella de aceite
6. Manual de instrucciones
7. Etiqueta indicadora del producto
8. Etiqueta de Advertencia
9. Tapón bloqueador

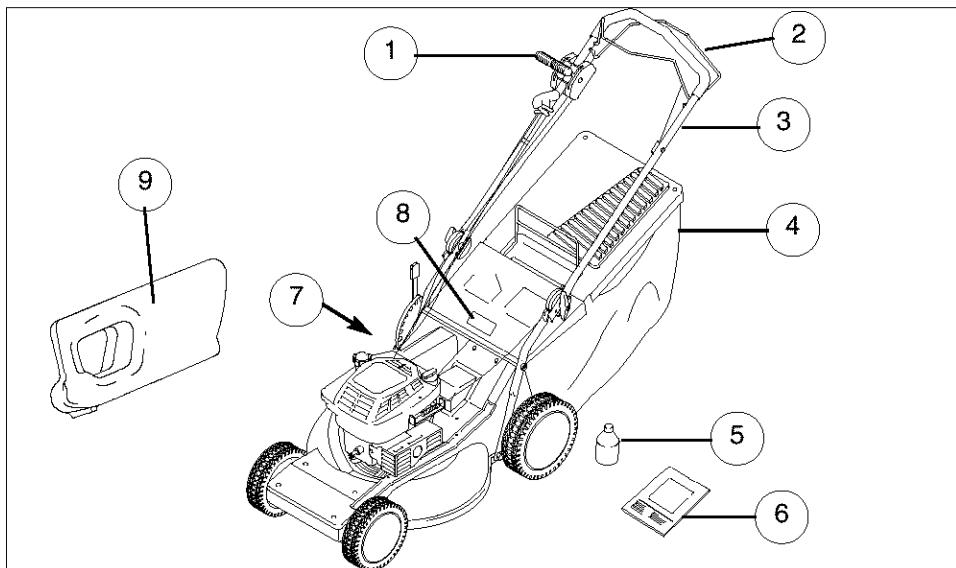

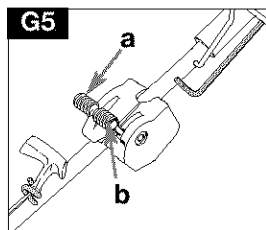
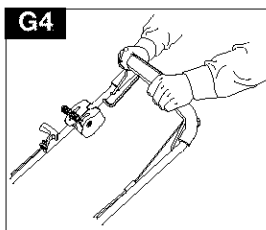
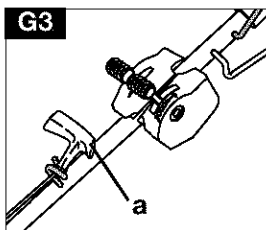
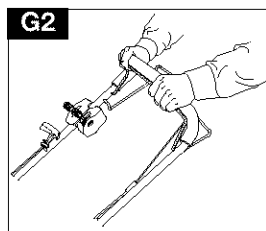
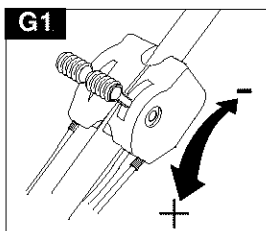
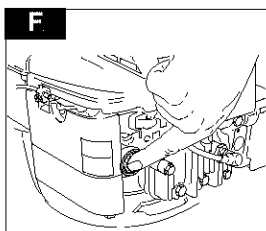
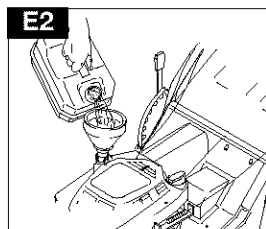
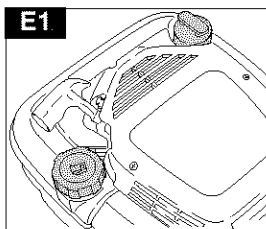
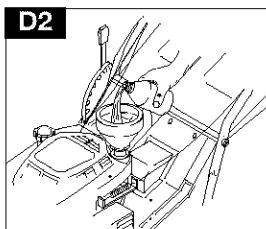
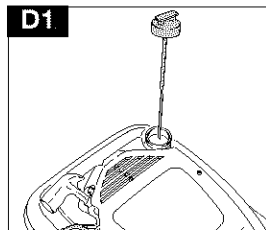
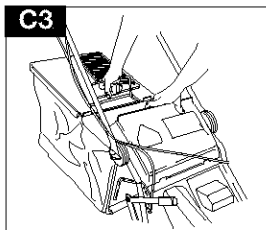
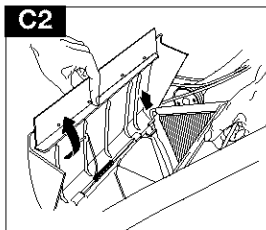
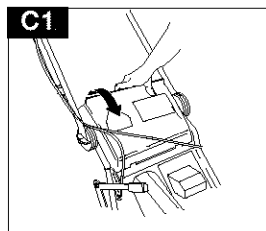
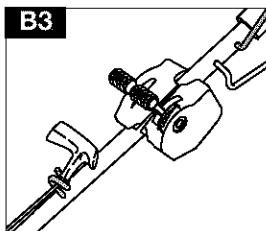
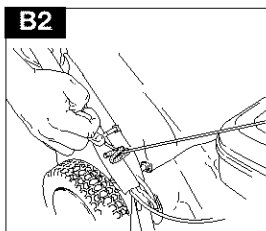
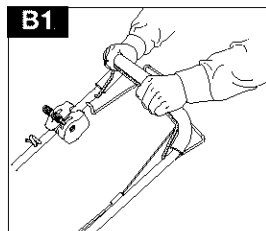
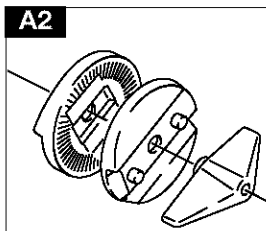
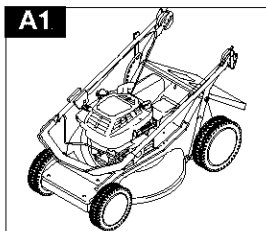

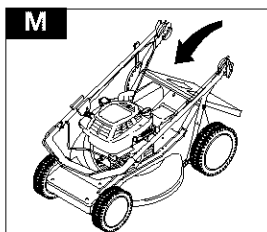
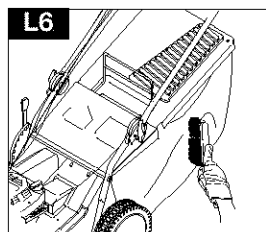
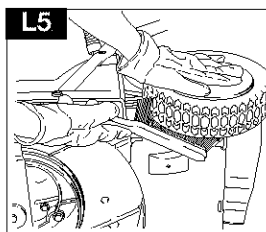
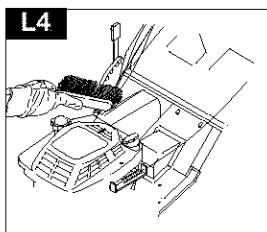
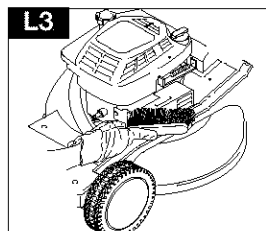
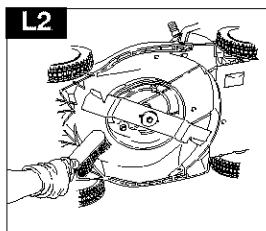
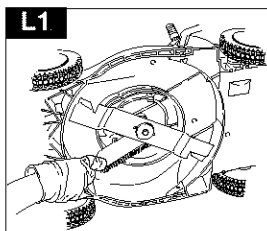
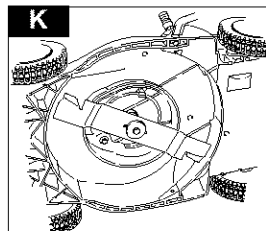
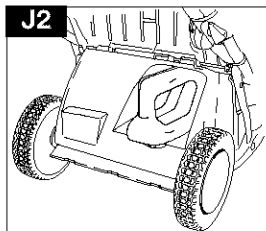
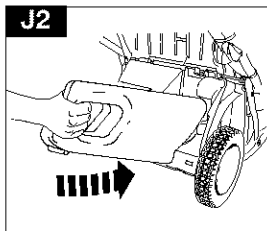
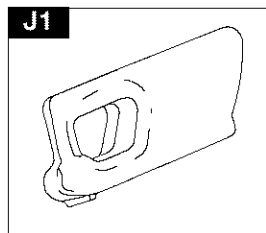
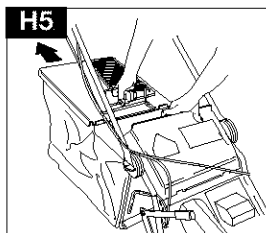
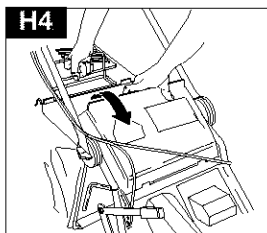
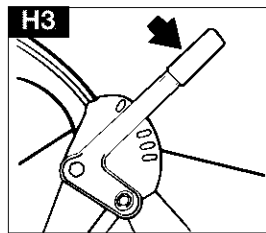
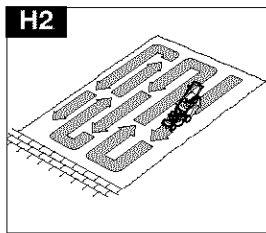
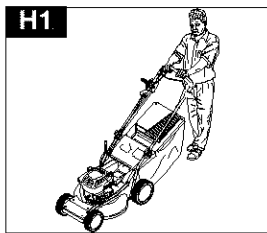

Safety Precautions



If not used properly this lawnmower can be dangerous! This lawnmower can cause serious injury to the operator and others, the warnings and safety instructions must be followed to ensure reasonable safety and efficiency in using this lawnmower. The operator is responsible for following the warning and safety instructions in this manual and on the lawnmower. Never use the mower unless the grasscatcher or guards provided by the manufacturer are in the correct position.

Explanation of Symbols on your Husqvarna Royal 53S Intek



Warning



Fuel



Oil



Danger, keep hands and feet away



Stop/Brake



Drive

General

1. Never allow children or people unfamiliar with these instructions to use the mower. Local regulations may restrict the age of the operator.
2. Only use the lawnmower in the manner and for the functions described in these instructions.
3. Never operate the lawnmower when you are tired, ill or under the influence of alcohol, drugs or medicine.
4. The operator or user is responsible for accidents or hazards occurring to other people or their property.

Fuel Safety

WARNING - Gasoline is highly flammable

- Store fuel in a cool place in a container specifically designed for the purpose.
- refuel outdoors only and do not smoke while refuelling
- add fuel **BEFORE** starting the engine. Never remove the cap of the fuel tank or add fuel while the engine is running or when the engine is hot if gasoline is spilled, do not attempt to start the engine but move the machine away from the area of spillage and avoid creating any source of ignition until gasoline vapours have dissipated

- replace all fuel tanks and container caps securely
- move the product away from the fueling area before starting

Preparation

1. While using your product always wear substantial footwear and long trousers.
2. Always wear safety goggles or safety glasses with side shields when operating mower.
3. The use of ear protection is recommended.
4. Make sure the lawn is clear of sticks, stones, bones, wire and debris; they could be thrown by the blade.
5. Before using the machine and after any impact, check for signs of wear or damage and repair as necessary.
6. Replace worn or damaged blades together with their fixings in sets to preserve balance.
7. Have faulty silencers replaced.

Children

Tragic accidents can occur if the operator is not alert to the presence of children. Children are often attracted to the machine and the mowing activity. Never assume that children will remain where you last saw them.

- Keep children out of the mowing area and under the watchful care of another responsible adult.
- Be alert and turn machine off if children enter the area.
- Before and while walking backwards, look behind and down for small children.
- Never allow children to operate the machine.
- use extra care when approaching blind corners, shrubs, trees, or other objects that may obscure vision.

Use

1. Do not operate the engine in a confined space where exhaust fumes (carbon monoxide) can collect.
2. Use the lawnmower only in daylight or good artificial light.
3. Avoid operating your lawnmower in wet grass, where feasible.
4. Take care in wet grass, you may lose your footing.
5. On slopes, be extra careful of your footing and wear non-slip footwear.
6. Mow across the face of slopes, never up and down.
7. Exercise extreme caution when changing direction on slopes.
8. Mowing on banks and slopes can be dangerous. Do not mow on **banks** or **steep** slopes.
9. Do not walk backwards when mowing, you could trip. Walk never run.
10. Never cut grass by pulling the mower towards you.
11. Stop the engine before pushing the mower across surfaces other than grass and when transporting the lawnmower to and from the area to be mowed.

Safety Precautions

- Never operate the lawnmower with damaged guards or without guards in place.
- Do not overspeed the engine or alter governor settings. Excessive speed is dangerous and shortens lawnmower life.
- Disengage all blade and drive clutches before starting.
- Keep hands and feet away from the cutting means at all times and especially when switching on the engine.
- Do not tilt lawnmower when starting the engine
- Do not put hands near the grass discharge chute whilst engine is running.
- Never pick up or carry a lawnmower while the engine is running
- Spark plug wire may be hot - handle with care.
- Do not attempt any maintenance on your lawnmower when the engine is hot.
- Stop the engine, and wait until the blade has stopped:-
 - before leaving the mower unattended for any period.
- Release the Operator Presence Control to stop the engine, wait until the blade has stopped, disconnect the spark plug lead and wait until the engine has cooled:-
 - before refueling;
 - before clearing a blockage;
 - before checking, cleaning or working on the appliance;
 - if you hit an object. Do not use your lawnmower until you are sure that the entire lawnmower is in a safe operating condition.;
 - if the lawnmower starts to vibrate abnormally. Check immediately. Excessive vibration can cause injury.
- Reduce the throttle setting during engine shut down and, if the engine is provided with a shut-off valve, turn the fuel off at the conclusion of mowing.

Maintenance and storage

- Keep all nuts, bolts and screws tight to be sure the lawnmower is in safe working condition.
- Check the grasscatcher frequently for wear or deterioration.
- Replace worn or damaged parts for safety.
- Only use the replacement blade, blade bolt, spacer and impeller specified for this product.
- Never store the lawnmower with fuel in the tank inside a building where fumes can reach an open flame or spark.
- Allow the engine to cool before storing in any enclosure.
- To reduce fire hazard, keep the engine, silencer, battery compartment and fuel storage area free of grass, leaves or excessive grease.
- If the fuel tank has to be drained, this should be done outdoors.
- Be careful during adjustment of the machine to prevent entrapment of the fingers between moving blades and fixed parts of the machine.

Assembly Instructions

Handle Assembly

- Your product is supplied with the handles folded over the product. **(A1)**
- Loosen handle adjusters **(A2)** on both sides of the product and lift handle assembly up.
- Adjust handle assembly to the most comfortable operating position and tighten handle adjusters **(A2)** on both sides of the product

Recoil Starter

- Disconnect the spark plug lead.
- Pull the Operator Presence Control **(B1)** to release the brake on the engine.

You must release the brake by pulling the OPC lever to the handle before pulling out the cord.

- Locate cord in the pull cord guide on the lower handle. **(B2)**

- Locate cord in the pull cord guide on the upper handle. **(B3)**

Fitting the Grasscatcher

- Lift safety flap. **(C1)**
- Place the grasscatcher onto the hooks. **(C2)**
- Lower the grasscatcher onto the rear surface of the mower.
- Locate safety flap onto the top of the grasscatcher. **(C3)**. Ensure the grasscatcher is securely located.

Please Note :- Ensure no gap remains between the safety flap and the grasscatcher

Where grass collection is not required you can use the lawnmower without the grasscatcher. Ensure the safety flap is fully closed.

Engine Notes

Oil

- Check oil level periodically and after every five hours of operation.
- Add oil as necessary to keep the level to the FULL mark on the dipstick.
- Use a good quality SAE 30 four stroke oil.
- To fill with oil:-
 - Remove oil filler cap. **(D1)**
 - Fill to the FULL mark on the dipstick. **(D2)**
- Change the oil after the first five hours operation and thereafter every 25 working hours.
- Always change the oil while the engine is warm - but not hot - never attempt any maintenance on a hot engine.

Gasoline

- Use fresh regular grade lead free gasoline.
- Do not fill the fuel tank when the engine is hot.
- Do not fill the fuel tank while smoking.
- Do not fill the fuel tank while the engine is running.
- To avoid introducing dirt into the fuel system, wipe all grass and dirt from the gasoline filler cap before unscrewing it. **(E1)**
- It is recommended that you fill the tank through a funnel with a filter. **(E2)**
- Wipe away spillages before starting.

Please Note :- move the product away from the fuelling area before starting

Starting - Priming the Engine

Please Note:- When starting the engine for the first time, fill with oil and gasoline as described above in the **Oil and Gasoline** section. Priming is usually unnecessary when restarting a warm engine. However, cool weather may require priming to be repeated.

Starting the engine for the first time

1. Advance engine speed control to FAST '+' as illustrated in the **Use - starting and stopping** section.
2. Push primer bulb (F) firmly five times.

3. Follow instructions in the **Use - starting and stopping** section.
4. If engine fails to start after three pulls of the pull cord, push primer bulb three times and repeat step 3.

Starting engine thereafter

1. Move engine speed control to FAST '+' position and push primer bulb firmly three times before starting engine. (if engine stopped because it ran out of fuel, refuel engine - push primer bulb three times.

Use - Starting and Stopping

**G3-a - Recoil Starter G5-a - Drive Speed Control
G5-b - Engine Speed Control**

Starting & Stopping Royal 53S Intek.

Starting

1. Connect the spark plug lead.
2. Move the Engine Speed Control to the FAST '+' position before starting. (G1)
3. Pull the operator presence control (OPC) to release the brake on the engine and the blade.(G2)
4. Pull the recoil starter fully towards you until you feel the full resistance, return the handle slowly then pull the handle firmly towards you to its full extent. (G3)

5. After the engine has started, allow to run for 30 seconds before commencing to use.

Engaging the Drive

1. Forward drive is engaged and disengaged with the Powerdrive lever at the top of the handle (G4).
2. Drive speed can be altered with the drive speed control. (G5)
3. Releasing the Powerdrive Lever stops the forward drive automatically.

Stopping

1. Release the powerdrive lever.
2. Release the OPC lever.

Use - Mowing

How to Mow

1. Always use the correct mowing position (H1).
2. Start mowing from the outside edge of the lawn, mowing in strips in alternate directions (H2).
3. Mow twice a week in the growing season, your lawn will suffer if more than one third of its length is cut at one time and this may also result in poor collection.

Cutting Height Adjustment

1. The height of cut is altered by pulling the adjustment lever away from the location slots and moving to the selected position (H3).

Emptying the Grasscatcher

1. Lift the safety flap (H4).
2. Remove the grasscatcher from the machine (H5)
3. Empty grasscatcher.

Please Note:-

Do not overload your Lawnmower

When mowing in long thick grass a first cut with the cutting height adjusted to its highest setting, see **Cutting Height**, will help reduce engine overload and will help prevent damage to your lawnmower.

Using as a mulcher

1. Your lawnmower is supplied with a mulching plug (J1).
2. Stop your lawnmower as described in **Use - starting and stopping**, and disconnect the spark plug.
3. Lift safety flap. Slide mulching plug into rear discharge chute. (J2)
4. Ensure mulching plug is securely fitted. (J3)
5. The mulching plug prevents grass from being collected by blocking the collection chute on the underside of the deck.
6. Ensure the safety flap is positioned correctly.

Cutting System (K)

Always handle the blade with care - sharp edges could cause injury. USE GLOVES.

Replace your metal blade after 50 hours mowing or 2 years whichever is the sooner - regardless of condition. If the blade is cracked or damaged replace it with a new one.

Removing the Blade

- Disconnect the spark plug lead.
1. Use wrench to loosen blade bolt by turning anti-clockwise.

2. Remove the blade bolt, blade and spacer washer.
3. Inspect for damage and clean as necessary.

Fitting the Blade

1. Fit the blade to the machine with the sharp edges pointing away from the machine.
2. Re-assemble blade bolt through blade and spacer washer.
3. Hold firmly and tighten blade bolt firmly with a wrench. Do not over tighten.

Maintenance

IMPORTANT

Do not attempt any maintenance on your lawnmower when the engine is hot.

IMPORTANT

Never use water for cleaning your lawnmower. Do not clean with chemical, including gasoline, or solvents - some can destroy critical plastic parts.

Cleaning

- Disconnect the spark plug lead.
1. Remove grass from under the deck with a brush (L1 and L2).
 2. Using a soft brush - remove grass clippings from the engine air intakes and exhaust (L3), cutting height adjustment area. (L4), around the wheels (L5) and the grasscatcher (L6).
 3. Wipe over the surface of your lawnmower with a dry cloth.

Maintenance

The engine brake cable should always be adjusted to stop the engine within 3 sec.

CAUTION! For adjustment contact your authorized service dealer.

At the End of the Mowing Season

1. Replace blade, bolts, nuts or screws, if necessary.
2. Clean your lawnmower thoroughly.
3. Ask your local service dealer to clean the air filter thoroughly and carry out any service or repairs required.
4. Drain engine of oil and gasoline.

Storing your Lawnmower

1. Do not store your lawnmower immediately after use.
2. Wait until the engine has cooled to avoid a potential fire hazard.
3. Disconnect the spark plug lead.
4. Clean your lawnmower
5. Loosen handle adjusters (**A2**) on both sides of the product and fold the handle forward. (**M**)
6. Store in a cool, dry place where your lawnmower is protected from damage.

Service Recommendations

Your product is uniquely identified by a silver and black product rating label.

We strongly recommend that your product is serviced at least every twelve months, more often in a professional application.

Engine Maintenance Schedule

Follow the hourly or calendar intervals, whichever occur first. More frequent service is required when operating in adverse conditions

First 5 hours - Change oil.

Every 5 hours or daily - Check oil level. Clean finger guard. Clean around muffler.

Every 25 hours or every season - Change oil if operating under heavy load or high ambient temperature. Service air cleaner.

Every 50 hours or every season - Change oil. Inspect spark arrester, if equipped.

Every 100 hours or every season - Clean cooling system*. Replace spark plug.

* Clean more often under dusty conditions, or when airborne debris is present or after prolonged operation cutting tall, dry grass.

Engine Servicing & Guarantee

The engine fitted to your lawnmower is guaranteed by the Engine Manufacturer. To obtain further information contact your dealer.

Trouble Shooting

Engine Will Not Start

1. Ensure **OPC Lever** is in the start position.
2. Check that the control lever is in the '+' position
3. Check that there is sufficient fuel in the tank and the cap air vent is clear.
4. Remove and dry the spark plug.
5. Gasoline may be stale, replace. Once gasoline has been replaced, it may take a little time for fresh gasoline to filter through.
6. Check that the blade bolt is tight. A loose bolt could cause difficult starting.
7. **If the engine will still not start, immediately disconnect the spark plug lead.**
8. **CONSULT YOUR LOCAL APPROVED SERVICE DEALER.**

Lack of Engine Power and/or Overheating

1. Check that the control lever is in the 'normal' position.
2. Disconnect the spark plug lead and allow the engine to cool down.
3. Clean grass clippings and debris from around the engine and air inlets and the underside of the deck including the chute.
4. Clean the engine air filter (Ask your local Approved Service Dealer to clean the engine air filter thoroughly).
5. Gasoline may be stale, replace. Once gasoline has been replaced, it may take a little time for fresh gasoline to filter through.
6. **If the engine still lacks power and/or is overheating, immediately disconnect the spark plug lead.**
7. **CONSULT YOUR LOCAL APPROVED SERVICE DEALER.**

Excessive Vibration

1. Disconnect the spark plug lead.
2. Check that the blade is correctly fitted.
3. If the blade is damaged or worn replace it with a new one.
4. **If vibration persists, immediately disconnect the spark plug lead.**
5. **CONSULT YOUR LOCAL APPROVED SERVICE DEALER.**

Environmental Information

Electrolux Outdoor Products are manufactured under an Environmental Management System (ISO 14001) using, where practical, components manufactured in the most environmentally responsible manner, according to company procedures, and with the potential for recycling at the end of the products' life.

- Packaging is recyclable and plastic components have been labelled (where practical) for categorised recycling.
- Awareness of the environment must be considered when disposing of 'end-of-life' product.
- If necessary, contact your local authority for disposal information.

DISPOSAL OF FUELS AND LUBRICATING OILS

- Wear protective clothing when handling any fuels and lubricants.
- Avoid contact with skin.
- Remove gasoline and engine oil before transporting the product.
- Contact your local authority for information of your nearest Recycling/Disposal Station.
- **Do NOT dispose of used fuels/oils with household waste**
- **Waste fuels/oils are harmful, but can be recycled and should be disposed of through the recognised facilities.**
- **Do NOT dispose of used fuels/oils to water.**
- **Do NOT incinerate**

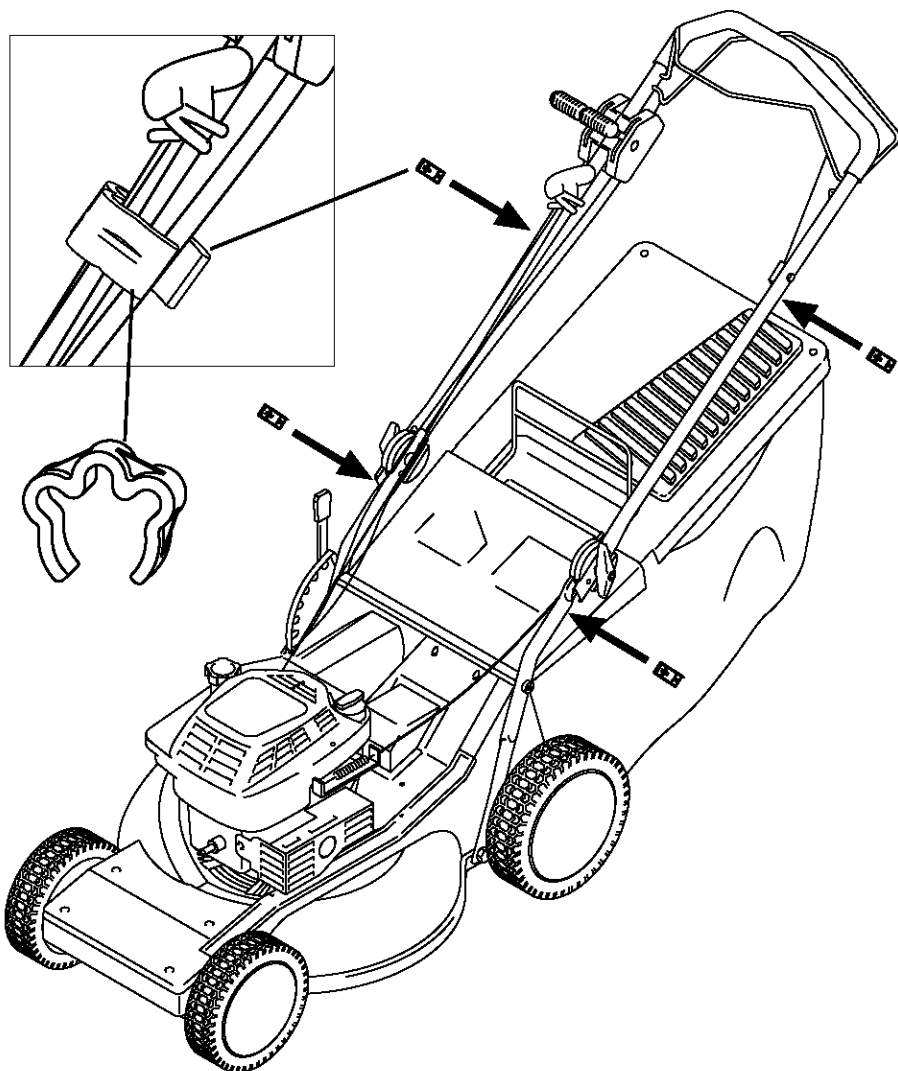

5119513-01





 **Husqvarna**

