



DRAPER[®]

230V 165/195BAR **PRESSURE WASHERS**

98678 & 98679



These instructions accompanying the product are the original instructions. This document is part of the product, keep it for the life of the product passing it on to any subsequent holder of the product. Read all these instructions before assembling, operating or maintaining this product.

This manual has been compiled by Draper Tools describing the purpose for which the product has been designed, and contains all the necessary information to ensure its correct and safe use. By following all the general safety instructions contained in this manual, it will ensure both product and operator safety, together with longer life of the product itself.

All photographs and drawings in this manual are supplied by Draper Tools to help illustrate the operation of the product.

Whilst every effort has been made to ensure the accuracy of information contained in this manual, the Draper Tools policy of continuous improvement determines the right to make modifications without prior warning.

1. TITLE PAGE

1.1 INTRODUCTION:

USER MANUAL FOR: 230V 165/195BAR Pressure Washers

Stock No: 98678 & 98679

Part No: PW2100I/110D & PW2500I/135D

1.2 REVISIONS:

Date first published October 2020.

As our user manuals are continually updated, users should make sure that they use the very latest version.

Downloads are available from: <http://drapertools.com/manuals>

Draper Tools Limited
Hursley Road
Chandler's Ford
Eastleigh
Hampshire
SO53 1YF
UK

Website: drapertools.com

Product Help Line: +44 (0) 23 8049 4344

General Fax: +44 (0) 23 8026 0784

1.3 UNDERSTANDING THIS MANUALS SAFETY CONTENT:

Warning! – Information that draws attention to the risk of injury or death.

Important – Information that draws attention to the risk of damage to the product or surroundings.

1.4 COPYRIGHT © NOTICE:

Copyright © Draper Tools Limited.

Permission is granted to reproduce this publication for personal and educational use only.

Commercial copying, redistribution, hiring or lending is prohibited.

No part of this publication may be stored in a retrieval system or transmitted in any other form or means without written permission from Draper Tools Limited.

In all cases this copyright notice must remain intact.

2. CONTENTS

2.1 TABLE OF CONTENTS

1. TITLE PAGE

1.1	INTRODUCTION:.....	2
1.2	REVISIONS:.....	2
1.3	UNDERSTANDING THIS MANUALS SAFETY CONTENT:.....	2
1.4	COPYRIGHT © NOTICE:.....	2

3. WARRANTY

3.1	WARRANTY	5
-----	----------------	---

4. INTRODUCTION

4.1	SCOPE.....	6
4.2	SPECIFICATION.....	6
4.3	HANDLING AND STORAGE.....	6

5. HEALTH AND SAFETY INFORMATION

5.1	GENERAL SAFETY INSTRUCTIONS FOR POWER TOOL USE	7
5.2	ADDITIONAL SAFETY INSTRUCTIONS FOR PRESSURE WASHER USE	8
5.3	RESIDUAL RISK.....	9
5.4	CONNECTION TO THE POWER SUPPLY.....	9

6. TECHNICAL DESCRIPTION

6.1	IDENTIFICATION.....	10
-----	---------------------	----

7. UNPACKING AND CHECKING

7.1	PACKAGING	11
7.2	WHAT'S IN THE BOX	11

8. ASSEMBLY

8.1	FITTING THE LANCE HOLDER	12
8.2	CABLE TIDY HOOKS	12
8.3	FITTING THE TURBO NOZZLE HOLDER	12
8.4	FITTING THE INTEGRATED DETERGENT BOTTLE.....	13
8.5	ASSEMBLING THE LANCE AND HOSE.....	13
8.6	ATTACHING THE WATER SUPPLY	14
8.7	TELESCOPIC HANDLE ADJUSTMENT (98678 ONLY).....	14
8.8	HOSE REEL.....	14

9. OPERATION

9.1	TOTAL STOP DEVICE.....	15
9.2	ON/OFF SWITCH	15
9.3	DETERGENT CONTROL (98679 ONLY).....	15
9.4	LANCE SAFETY LOCK	15
9.5	SPRAY NOZZLES.....	16
9.6	FIXED BRUSH.....	17
9.7	PATIO CLEANER.....	17

2. CONTENTS

- 11. MAINTENANCE AND TROUBLESHOOTING**
 - 11.1 MAINTENANCE 18
 - 11.2 TROUBLESHOOTING GUIDE..... 18
- 12. EXPLANATION OF SYMBOLS**
 - 12.1 EXPLANATION OF SYMBOLS..... 19
- 13. DISPOSAL**
 - 13.1 DISPOSAL 20
- DECLARATION OF CONFORMITY ENCLOSED**



3. WARRANTY

3.1 WARRANTY

Draper tools have been carefully tested and inspected before shipment and are guaranteed to be free from defective materials and workmanship.

Should the tool develop a fault, please return the complete tool to your nearest distributor or contact:

Draper Tools Limited, Chandler's Ford, Eastleigh, Hampshire, SO53 1YF. England.

Telephone Sales Desk: +44 (0) 8049 4333 or Product Help Line +44 (0) 23 8049 4344.

A proof of purchase **must** be provided with the tool.

If upon inspection it is found that the fault occurring is due to defective materials or workmanship, repairs will be carried out free of charge. This warranty period covering labour is 12 months from the date of purchase except where tools are hired out when the warranty period is 90 days from the date of purchase. The warranty is extended to 24 months for parts only. This warranty does not apply to any consumable parts, any type of battery or normal wear and tear, nor does it cover any damage caused by misuse, careless or unsafe handling, alterations, accidents, or repairs attempted or made by any personnel other than the authorised Draper warranty repair agent.

Note: If the tool is found not to be within the terms of warranty, repairs and carriage charges will be quoted and made accordingly.

This warranty applies in lieu of any other warranty expressed or implied and variations of its terms are not authorised.

Your Draper warranty is not effective unless you can produce upon request a dated receipt or invoice to verify your proof of purchase within the warranty period.

Please note that this warranty is an additional benefit and does not affect your statutory rights.

Draper Tools Limited.

4. INTRODUCTION

4.1 SCOPE

These portable pressure washers are highly specialized multifunctional machines which may be used to wash and clean cars, bikes and other outdoor equipment or garden patios, green houses etc. Any other application is considered misuse.

4.2 SPECIFICATION

Stock No	98678	98679
Part No	PW2100I/110D	PW2500I/135D
Rated voltage	230V~50Hz	230V~50Hz
Rated input	2100W	2500W
Working pump pressure	110bar (1595psi)	130bar (1885psi)
Max. pump pressure	165bar (2393psi)	195bar (2828psi)
Max. flow rate	7.2L/min (432L/hour)	8.0L/min (480L/hour)
Type of protection	IPX5	IPX5
Max. water feed temperature	50°C	50°C
Sound pressure level (LpA)	79dB(A)	81dB(A)
Sound power level (LWA)	96dB(A)	97dB(A)
Uncertainty (K)	3dB(A)	3dB(A)
Vibration level†:	2.929m/s ²	2.77m/s ²
Uncertainty (K)	1.5m/s ²	1.5m/s ²
Weight (machine and accessories)	18kg	25kg

4.3 HANDLING AND STORAGE

Note: Every machine is tested in its operating conditions, so it is normal for a few drops of water to be left inside it.

- This pressure washer and accompanying accessories should not be stored at, or below 0°C.
- Frozen water inside the machine can cause critical damage to pump and other components.
- Care must be taken when handling this product.
 - Dropping this power tool could have an effect on its accuracy and could also result in personal injury. This product is not a toy and must be respected.
- Environmental conditions can have a detrimental effect on this product if neglected.
 - Exposure to damp air can gradually corrode components. If the product is unprotected from dust and debris, components will become clogged.
 - If not cleaned and maintained correctly or regularly, the machine will not perform at its best.

5. HEALTH AND SAFETY INFORMATION

5.1 GENERAL SAFETY INSTRUCTIONS FOR POWER TOOL USE

When using any type of power tool there are steps that should be taken to make sure that you, as the user, remain safe.

Common sense and a respect for the tool will help reduce the risk of injury.

Read the instruction manual fully. Do not attempt any operation until you have read and understood this manual.

Most important you must know how to safely start and stop this machine, especially in an emergency.

Keep the work area tidy and clean. Attempting to clear clutter from around the machine during use will reduce your concentration. Mess on the floor creates a trip hazard. Any liquid spilt on the floor could result in you slipping.

Find a suitable location. If the machine is bench mounted, the location should provide good natural light or artificial lighting as a replacement. Avoid damp and dust locations as it will have a negative effect on the machine's performance. If the machine is portable do not expose the tool to rain. In all cases do not operate power tools near any flammable materials.

Keep bystanders away. Children, onlookers and passers by must be restricted from entering the work area for their own protection. The barrier must extend a suitable distance from the tool user.

Unplug and house all power tools that are not in use. A power tool should never be left unattended while connected to the power supply. They must be housed in a suitable location, away locked up and from children. This includes battery chargers.

Do not overload or misuse the tool. All tools are designed for a purpose and are limited to what they are capable of doing. Do not attempt to use a power tool (or adapt it in any way) for an application it is not designed for. Select a tool appropriate for the size of the job. Overloading a tool will result in tool failure and user injury. This covers the use of accessories.

Dress properly. Loose clothing, long hair and jewellery are all dangerous because they can become entangled in moving machinery. This can also result in parts of body being pulled into the machine. Clothing should be close fitted, with any long hair tied back and jewellery and neck ties removed. Footwear must be fully enclosed and have a non-slip sole.

Wear personal protective equipment (PPE). Dust, noise, vibration and swarf can all be dangerous if not suitably protected against. If the work involving the power tool creates dust or fumes wear a dust mask. Vibration to the hand, caused by operating some tools for longer periods must be protected against. Wear vibration reducing gloves and allow long breaks between uses. Protect against dust and swarf by wearing approved safety goggles or a face shield. These are some of the more common hazards and preventions, however, always find out what hazards are associated with the machine/work process and wear the most suitable protective equipment available.

Do not breathe contaminated air. If the work creates dust or fumes connect the machine (if possible) to an extraction system either locally or remotely. Working outdoors can also help if possible.

Move the machine as instructed. If the machine is hand held, do not carry it by the power supply cable. If the product is heavy, employ a second or third person to help move it safely or use a mechanical device. Always refer to the instructions for the correct method.

Do not overreach. Extending your body too far can result in a loss of balance and you falling. This could be from a height or onto a machine and will result in injury.

Maintain your tools correctly. A well maintained tool will do the job safely. Replace any damaged or missing parts immediately with original parts from the manufacturer. As applicable, keep blades sharp, moving parts clean, oiled or greased, handles clean, and emergency devices working.

5. HEALTH AND SAFETY INFORMATION

Wait for the machine to stop. Unless the machine is fitted with a safety brake, some parts may continue to move due to momentum. Wait for all parts to stop, then unplug it from the power supply before making any adjustments, carrying out maintenance operations or just finishing using the tool.

Remove and check setting tools. Some machinery requires the use of additional tools or keys to set, load or adjust the power tool. Before starting the power tool always check to make certain they have been removed and are safely away from the machine.

Prevent unintentional starting. Before plugging any machine in to the power supply, make sure the switch is in the OFF position. If the machine is portable, do not hold the machine near the switch and take care when putting the machine down, that nothing can operate the switch.

Carefully select an extension lead. Some machines are not suitable for use with extension leads. If the tool is designed for use outdoors, use an extension lead also suitable for that environment. When using an extended lead, select one capable of handling the current (amps) drawn by the machine in use. Fully extend the lead regardless of the distance between the power supply and the tool. Excess current (amps) and a coiled extension lead will both cause the cable to heat up and can result in fire.

Concentrate and stay alert. Distractions are likely to cause an accident. Never operate a power tool if you are under the influence of drugs (prescription or otherwise), including alcohol or if you are feeling tired. Being disorientated will result in an accident.

Have this tool repaired by a qualified person. This tool is designed to conform to the relevant international and local standards and as such should be maintained and repaired by someone qualified, using only original parts supplied by the manufacturer. This will ensure the tool remains safe to use.

5.2 ADDITIONAL SAFETY INSTRUCTIONS FOR PRESSURE WASHER USE

Warning!

- This appliance is for outdoor use only.
- Always disconnect the electricity and water supplies on completion of every job.
- Never use the appliance if the electrical cable or important parts of the appliance are damaged, e.g. safety devices, high pressure hose, gun, etc.
- This appliance has been designed for use with a neutral shampoo based on biodegradable anionic surface active detergents. The use of other detergents or chemicals may put the appliance's safety at risk.
- Never use the appliance with people in the vicinity, unless they are wearing protective clothing.
- Do not direct the nozzle toward mechanical parts containing lubricant grease, as the grease will dissolve and spread over the surrounding ground. Vehicle tyres/tyre valves may only be cleaned from a minimum distance of 30cm, otherwise the vehicle tyre/tyre valve could be damaged by the high-pressure jet. The first indication of this is a discolouration of the tyre. Damaged vehicle tyres/tyre valves can be deadly dangerous.
- High pressure jets may be dangerous if improperly used. Jets must never be pointed at people, animals, live electrical equipment or the appliance itself.
- The hoses, accessories and high pressure couplings are important for the appliance's safety. Use only hoses, accessories and couplings recommended (it is extremely important to protect these components against damage by avoiding their improper use and protecting them against bending, knocks and scratches).
- The gun is fitted with a safety catch. Whenever use of the machine is interrupted it is important to operate the safety catch to prevent accidental activation of the jet.
- Never point the jet at yourself or others to clean clothing or footwear.
- Never allow children or untrained people to use the appliance.

5. HEALTH AND SAFETY INFORMATION

- The safety button on the gun is not there to lock the lever during operation, but to prevent its accidental operation.
- Appliances equipped with Total Stop System: these appliances should not be left in standby for more than 5 minutes.
- Switch the appliance off completely (master switch ON/OFF) whenever it is left unattended.
- Take care not to damage the electric cable. Have a damaged power cord replaced immediately by an authorized service point or an electrical specialist.
- The high pressure hose is designed and produced to withstand high pressures. To avoid damage, it must be handled with special care. Misuse may lead to premature breakages or damage and cause the loss of warranty cover.
- Never start the high-pressure cleaner without first completely unwinding the high-pressure hose.
- When winding and unwinding the hose take care not to cause the high pressure cleaner to overturn.
- Before unwinding or winding the hose, switch the machine off and release the pressure in the hose itself (switching off).

5.3 RESIDUAL RISK

Important: Although the safety instructions and operating manuals for our tools contain extensive instructions of safe working with power tools, every power tool involves a certain residual risk which can not be completely excluded by safety mechanisms. Power tools must therefore always be operated with caution!

5.4 CONNECTION TO THE POWER SUPPLY

Caution: Risk of electric shock. Do not open.

This appliance is supplied with an approved plug and cable for your safety. The value of the fuse fitted is marked on the pin face of the plug. Should the fuse need replacing, ensure the substitute is of the correct rating, approved to BS1362 and ASTA or BS Kite marked.

ASTA 

BSI 

The fuse cover is removable with a small plain slot screwdriver. Ensure the fuse cover is replaced before attempting to connect the plug to an electrical outlet. If the cover is missing, a replacement must be obtained or the plug replaced with a suitable type.

If a replacement plug is to be fitted this must be carried out by a qualified electrician.

The damaged or incomplete plug, when cut from the cable should be disabled to prevent connection to a live electrical outlet.

This appliance is Class I[†] and is designed for connection to a power supply matching that detailed on the rating label and compatible with the plug fitted.

If an extension lead is required, use an approved and compatible lead rated for this appliance. Follow all the instructions supplied with the extension lead.

[†]Earthed : This product requires an earth connection to protect against electric shock from accessible conductive parts in the event of failure if the basic insulation.

IMPORTANT

If using an extension lead, follow the instructions that came with your lead regarding maximum load while cable is wound. If in doubt, ensure that the entire cable is unwound. Using a coiled extension lead will generate heat which could melt the lead and cause a fire.

6. TECHNICAL DESCRIPTION

6.1 IDENTIFICATION

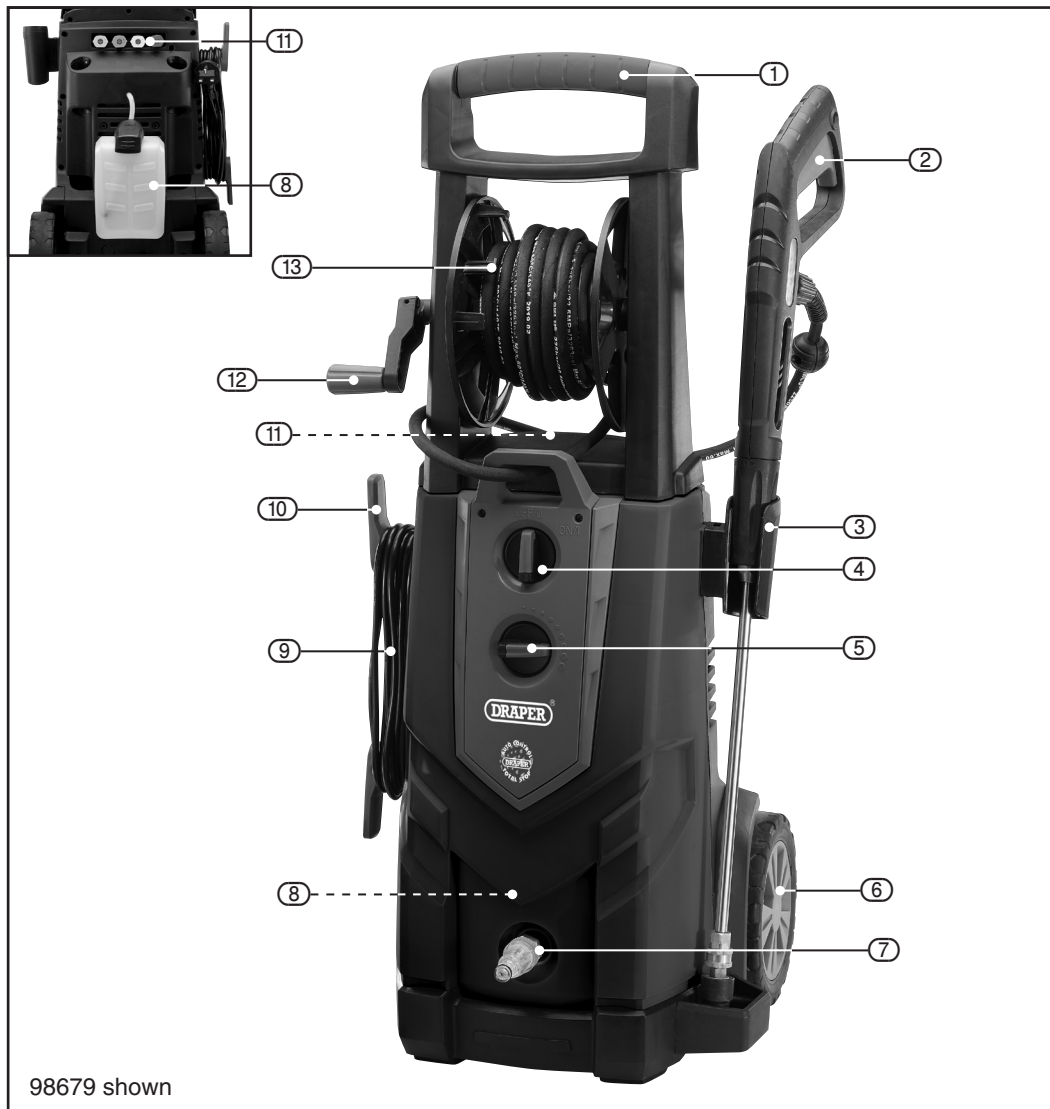

98679 shown

- ① Transport handle.
- ② Spray release trigger.
- ③ Lance holder.
- ④ Power supply ON/OFF switch.
- ⑤ Detergent flow adjustment (98679 only).
- ⑥ Transport wheels.
- ⑦ Water inlet.
- ⑧ Integrated detergent bottle.
- ⑨ Moulded approved plug and cable.
- ⑩ Cable hook.
- ⑪ Spare nozzles storage.
- ⑫ Hose reel handle.
- ⑬ 8M steel armoured hose (98679 only - 6M PVC hose on 98678).

7. UNPACKING AND CHECKING

7.1 PACKAGING

Carefully remove the product from the packaging and examine it for any sign of damage that may have happened during shipping. Lay the contents out and check them against the parts shown below. If any part is damaged or missing, please contact the Draper Help Line (the telephone number appears on the Title page) and do not attempt to use the product.

The packaging material should be retained at least during the warranty period, in case the machine needs to be returned for repair.

Warning!

- Some of the packaging materials used may be harmful to children. Do not leave any of these materials in the reach of children.
- If any of the packaging is to be thrown away, make sure they are disposed of correctly, according to local regulations.

7.2 WHAT'S IN THE BOX

As well as the main product, there are several parts not fitted or attached to it.

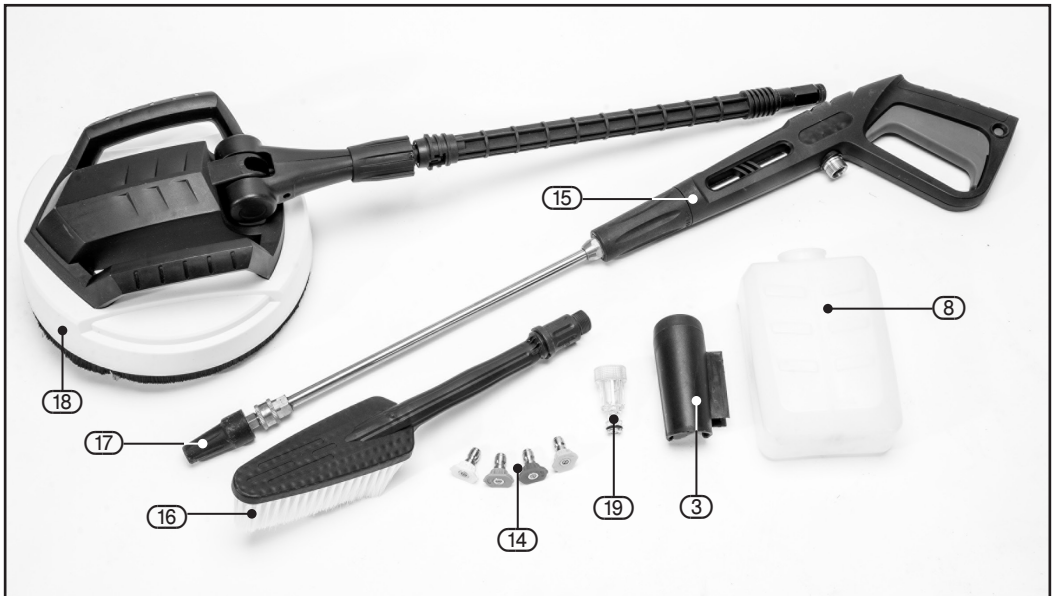

- | | |
|---------------------------|-----------------------------|
| ③ Lance holder. | ⑰ Turbo nozzle. |
| ⑧ Detergent bottle. | ⑱ Patio cleaner attachment. |
| ⑭ Spray nozzles. | ⑲ Water inlet adaptor. |
| ⑮ Lance. | |
| ⑯ Fixed brush attachment. | |

Note: For details of our full range of accessories and consumables, please visit drapertools.com

8. ASSEMBLY

8.1 FITTING THE LANCE HOLDER - FIGS. 1 - 2

To attach the side lance holder (3) simply locate and slide onto side of pressure washer body, as shown.

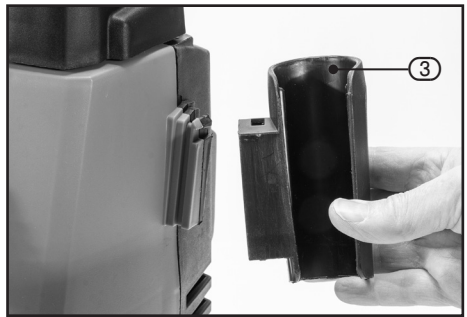

FIG.1

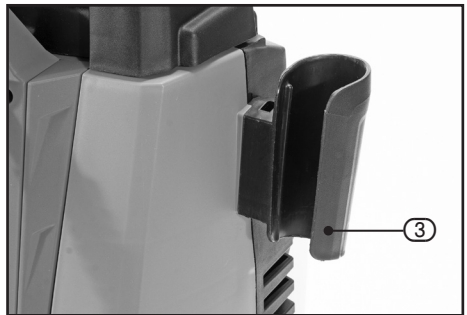

FIG.2

8.2 CABLE TIDY HOOKS - FIG. 3

The two cable tidy hooks (10) on 98679 machine both rotate 360°.

(98678 has one cable hook, but this does not rotate).

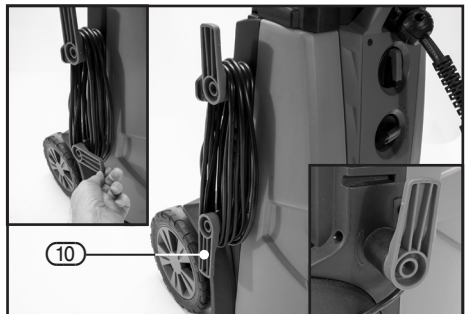

FIG.3

8.3 FITTING THE TURBO NOZZLE HOLDER - FIG. 4

98679 machine comes with a holder for the black turbo nozzle. To fit simply screw in position as shown.

98678 has built in storage for spare nozzles.

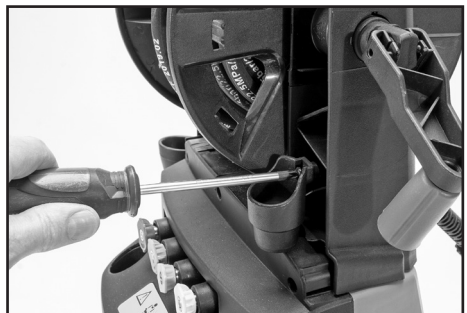

FIG.4

8. ASSEMBLY

8.4 FITTING THE INTEGRATED DETERGENT BOTTLE - FIGS. 5 - 6

Fill the detergent bottle (8) with a suitable detergent. Slot the bottle onto the back of the pressure washer and attach the cap, making sure the hose goes into the detergent liquid.

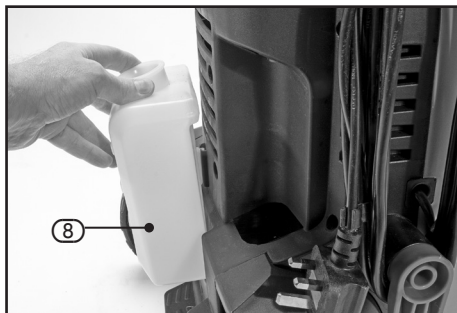

FIG.5



FIG.6

8.5 ASSEMBLING THE LANCE AND HOSE - FIGS. 7 - 8

Connect the end of the hose to the spray gun lance (15) by screwing the end connection in place. Make sure it is connected securely before use.



FIG.7



FIG.8

8. ASSEMBLY

8.6 ATTACHING THE WATER SUPPLY - FIGS. 9 - 10

Screw the supplied water inlet adaptor (19) to the water inlet taking care not to cross the threads.

To connect the pressure washer to the water supply, a push fit hose connector will be required. Ensure the connector is correctly fitted to the hose and that a 'click' is heard when attaching to the machine.

NOTE: Max. water temp: 50°C.

Always observe local bye-laws and regulations.



FIG.9



FIG.10

8.7 TELESCOPIC HANDLE ADJUSTMENT (98678 ONLY) - FIG. 11

98678 has a telescopic handle, allowing for adjustment in height. To adjust the height of the handle press the button (20) at the side of the pressure washer and move handle. Release button once at required position.



FIG.11

8.8 HOSE REEL - FIG. 12

The hose reel handle on both machines can be folded in for storage, and turned out when required for use, as shown.



FIG.12

9. OPERATION

9.1 TOTAL STOP DEVICE

This pressure washer is fitted with the **Auto Control Total Stop Device**. This will cause the motor to start and stop when the trigger is activated, unlike standard washers where the motor would run continuously.

This device reduces the amount of water and electricity used and the amount of wear and tear on the machines components. Also this helps cut down on the amount of noise emitted during use.

9.2 ON/OFF SWITCH – FIG. 13

Note: Do not run the motor DRY, and ensure the machine is switched OFF prior to plugging in.

To operate the pressure washer correctly carry out the following steps:

- Make sure the switch is in the OFF position.
- Plug in the pressure washer.
- Connect and turn on the water supply.
- Pull the trigger to bleed the air out of the system.
- Whilst the trigger is pulled switch on the pressure washer.
- When the air is purged release the trigger.

Ensure that during use the jet is not aimed at people, animals, electrical equipment or the pressure washer.

After use:

- Switch off the pressure washer and water supply and unplug the pressure washer.
- Pull the trigger to release the pressure and drain the water.
- Disassemble the machine, drain remaining water and store away safely.

9.3 DETERGENT CONTROL (98679 ONLY) - FIG. 14

This switch is used to adjust the flow rate of detergent when using the pressure washer. When you rotate clockwise, the flow rate of the cleaning solution will increase.

9.4 LANCE SAFETY LOCK – FIG. 15

The lance has a safety lock button, which must be depressed whenever not in use, to prevent accidental starting.



FIG.13



FIG.14



FIG.15

9. OPERATION

9.5 SPRAY NOZZLES - FIGS. 16 - 18

Note: Always make sure the pressure washer is OFF before swapping nozzles or attachments.

The pressure washer comes with four spray nozzles, which come stored on the back of the pressure washer, as well as a turbo nozzle. Each nozzle is color coded and delivers a specific spray pattern and pressure for particular uses detailed below. All of these nozzles fit to the lance as supplied.

0° Nozzle – Red:

This nozzle delivers a pin point stream of pressurized water and is extremely powerful. It covers only a small area of cleaning. This nozzle should only be directed at surfaces that can withstand high pressure such as metal or concrete. Do not use this nozzle to clean wood.

15° Nozzle – Yellow:

This nozzle delivers a powerful 15 degree spray pattern for intense cleaning of small areas. This nozzle should only be used on areas and materials that can withstand high pressure.

25° Nozzle – Green:

This nozzle delivers a 25 degree spray pattern for intense cleaning of larger areas. This nozzle should only be used on areas that can withstand pressure from this nozzle.

40° Nozzle – White:

This nozzle delivers a 40 degree spray pattern and a less powerful stream of water. This nozzle can cover a wide area and should be used for most general cleaning jobs.

Turbo Nozzle – Black:

This nozzle (which comes fitted to the lance) circulates a powerful spray into a circular pattern to provide greater cleaning efficiency over large areas.

Soap-on Nozzle – Black:

A sixth nozzle is also included. This is a low-pressure nozzle intended for the application of soap foam. When this nozzle is used, the washer will not create high pressure. This is by design and users should not be concerned that the pressure washer is not working correctly.



FIG.16



FIG.17



FIG.18

9. OPERATION

9.6 FIXED BRUSH - FIGS. 19 - 21

Note: Always make sure the pressure washer is OFF before swapping nozzles or attachments.

The pressure washer is supplied with a fixed brush (16). The brush has soft bristles and can be used in conjunction with the detergent dispenser to apply detergent to the surface you are cleaning. These are ideal for cleaning car bodywork, windows etc. This is a low pressure setting.

The fixed brush requires you to remove the lower section of the lance, and fit to the upper gun of the lance as shown.

Note: All these fittings are bayonet fittings which push in then twist to lock.



FIG.19

9.7 PATIO CLEANER - FIG. 22

Note: Always make sure the pressure washer is OFF before swapping nozzles or attachments.

The pressure washer is supplied with a patio cleaner attachment (18). The patio cleaner is ideal for quick and effective cleaning of large flat areas.

As with the fixed brush the patio cleaner attachment requires you to remove the lower section of the lance, and fit to the upper gun of the lance as shown.

Note: All these fittings are bayonet fittings which push in then twist to lock.



FIG.20

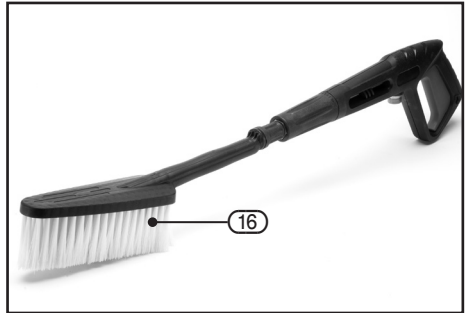

FIG.21

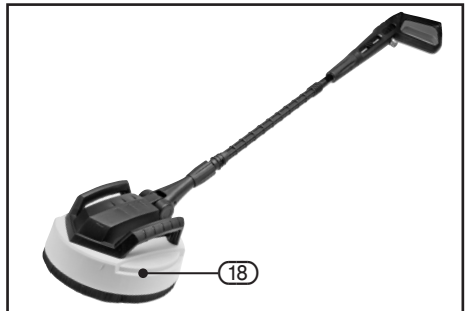

FIG.22

11. MAINTENANCE AND TROUBLESHOOTING

11.1 MAINTENANCE

Regular inspection and cleaning reduces the necessity for maintenance operations and will keep your tool in good working condition.

The motor must be correctly ventilated during tool operation. Avoid blocking the air inlets and vacuum the ventilation slots regularly.

11.2 TROUBLESHOOTING GUIDE

Problem	Possible Cause	Remedy
Motor pulsing.	1. Air in the system.	1. Bleed the gun (see p.14)
Pump fails to start.	1. Plug fuse blown.	1. Replace fuse.
	2. Cable damaged.	2. Have the cable replaced by a repair agent.
Pump starts/stops with the trigger operation.	1. Correct operation of the total stop device.	1. No issue.
Bad spray pattern.	1. Nozzle blocked.	1. Unblock nozzle.
Poor pressure.	1. Water leaks.	1. Check and tighten all connections.

12. EXPLANATION OF SYMBOLS

12.1 EXPLANATION OF SYMBOLS



Read the instruction manual.



Wear safety glasses.



Wear protective footwear.



Wear protective gloves.



Do not spray at animals or people.



For use with cool water. Do not exceed 50°C water temperature.



Earthed.



WEEE –
Waste Electrical & Electronic Equipment.
Do not dispose of Waste Electrical & Electronic
Equipment in with domestic rubbish.



Continuous A-Weighted Sound
Pressure Level.

13. DISPOSAL

13.1 DISPOSAL

- At the end of the machine's working life, or when it can no longer be repaired, ensure that it is disposed of according to national regulations.
- Contact your local authority for details of collection schemes in your area.

In all circumstances:

- Do not dispose of power tools with domestic waste.
- Do not incinerate.
- Do not dispose of WEEE* as unsorted municipal waste.



* *Waste Electrical & Electronic Equipment.*

CONTACTS

Draper Tools Limited, Hursley Road,
Chandler's Ford, Eastleigh, Hampshire. SO53 1YF. U.K.

Help Line: (023) 8049 4344

Sales Desk: (023) 8049 4333

Internet: drapertools.com

E-mail: sales@drapertools.com

General Enquiries: (023) 8026 6355

Service/Warranty Repair Agent:

For aftersales servicing or warranty repairs, please contact the Draper Tools Help Line for details of an agent in your local area.

YOUR DRAPER STOCKIST

TAJB0321

©Published by Draper Tools Limited.

No part of this publication may be reproduced, stored in a retrieval system or transmitted in any form or by any means, electronic, mechanical photocopying, recording or otherwise without prior permission in writing from Draper Tools Ltd.