

Installation instructions and User guide

Dishwasher

DW60 models

AU SG



Safety and warnings	2
Installation instructions	4
Introducing your dishwasher	8
Using your dishwasher	9
Selecting a wash programme	12
Caring for your dinnerware	13
Dishwasher standards test	14
Loading	15
Detergent	17
Rinse aid	18
Care and cleaning	19
Fault codes	21
Troubleshooting	22
Warranty and service	25

Important!

SAVE THESE INSTRUCTIONS

The models shown in this user guide may not be available in all markets and are subject to change at any time. For current details about model and specification availability in your country, please visit our local website listed on the back cover or contact your local Fisher & Paykel dealer.

Important safety precautions

For your safety, follow basic precautions when using your dishwasher, including the following:

- *Please read all instructions before operating your dishwasher.*
- *The information in this user guide must be followed to minimise the risk of fire or explosion, or to prevent property damage, personal injury or loss of life.*

Operational

- *Use the dishwasher only for its intended function as described in this user guide.*
- *Dishwasher detergents are alkaline. They can be dangerous if swallowed. Avoid contact with skin and eyes, and keep children and infirm persons away from the dishwasher when the door is open.*
- *Use only detergents or rinse aid recommended for use in a domestic dishwasher and keep them out of reach of children. Check that the detergent dispenser is empty after the completion of each wash programme.*
- *When loading items to be washed, place sharp items where they are not likely to damage the dishwasher and load sharp knives with the handles up to reduce the risk of cut type injuries.*
- *Do not tamper with the controls of your dishwasher.*
- *Do not abuse, sit on, or stand on the door or dish rack of your dishwasher. Do not place any heavy objects on the door when it is open. The dishwasher could tip forward.*
- *To reduce the risk of injury, do not allow children to play in or on the dishwasher.*
- *Under certain conditions hydrogen gas may be produced in a hot water heater system that has not been used for two weeks or more. HYDROGEN GAS IS EXPLOSIVE. If the hot water system has not been used for such a period, then before using the dishwasher, turn on all hot water taps and let the water flow from each for several minutes. This will release any accumulated hydrogen gas. As hydrogen gas is flammable, do not smoke or use an open flame during this time.*
- *Remove the door to the washing compartment when removing an old dishwasher from service or discarding it.*
- *Open the door very carefully if the dishwasher is in operation. There is a risk of being sprayed with hot water. Do not open the door fully until the spray arm has stopped rotating.*
- *The door should not be left in the open position as this could present a tripping hazard.*
- *When disconnecting the dishwasher pull by the plug rather than the cord or junction of cord to avoid damage.*
- *This dishwasher is not intended for use by young children or infirm persons unless they have been adequately supervised by a responsible person to ensure that they can use the dishwasher safely. Young children should be supervised to ensure that they do not play with the dishwasher.*
- *The water inside the dishwasher is not suitable for drinking.*
- *This dishwasher is designed for washing normal household utensils. Items that are contaminated by petrol, paint, steel or iron debris, or corrosive, acidic or alkaline chemicals are not to be washed in this dishwasher.*
- *If the dishwasher is not being used for long periods of time, turn the electricity and water supply to the dishwasher off.*

Installation

- *This dishwasher must be installed and positioned in accordance with the 'Installation instructions' before it is used.*
- *Installation and service should be performed by a qualified technician.*
- *If the power supply cord is damaged, it must be replaced by the manufacturer or Authorised Service Centre or a similarly qualified person in order to avoid a hazard.*
- *Ensure the dishwasher is placed between cabinetry. Failure to do so may result in an unstable product, which may cause damage or injury.*
- *Do not operate this dishwasher if it is damaged, malfunctioning, partially disassembled or has missing or broken parts, including a damaged power supply cord or plug.*
- *Do not store or use petrol or other flammable vapours and liquids in the vicinity of the dishwasher.*
- *Connect to a properly rated, protected and sized power supply circuit to avoid electrical overload.*
- *Make sure that the power supply cord is positioned where it will not be stepped on, tripped over, or otherwise subjected to damage or stress.*
- *Do not install or store the dishwasher where it will be exposed to temperatures below freezing or exposed to the weather.*
- *Do not use an extension cord or portable electrical outlet device (eg multi-socket outlet box) to connect the dishwasher to the power supply.*

Maintenance

- *Do not repair or replace any part of the dishwasher or attempt any servicing unless specifically recommended in this user guide. We recommend that you call a Fisher & Paykel Authorised Service Agent.*
- *Keep the floor around your dishwasher clean and dry to reduce the possibility of slipping.*
- *Keep the area around and underneath your dishwasher free from the accumulation of combustible materials, such as lint, paper, rags and chemicals.*
- *When cleaning the underside of the filter, take care on the sharp outer edge to avoid the risk of cut type injuries.*
- *If the dishwasher is not operating properly or maintenance must be performed, disconnect the dishwasher from the power supply.*

Before you start

- These instructions are intended as a guide only. It is the responsibility of the plumber and electrician to ensure that each installation complies with the Government and local government by-laws.
- Check packaging and dishwasher immediately for signs of transport damage. If the appliance is damaged, do not put into use but contact your Fisher & Paykel Authorised Service Centre or dealer.
- The dishwasher must not be connected to the electrical supply while installation is being carried out. Ensure all domestic wiring is properly earthed.
- Never lift from the door handle.
Do not lift from the decorative panel on the front of the dishwasher. Always be careful with the hoses and the power cord at the back of the dishwasher. Careful handling will prevent damage and malfunction from squashing, kinking or cuts.
- The dishwasher should not be connected to a hot water system where the temperature exceeds 60°C, or where there is no temperature control, eg wetback system unless the system is fitted with a suitable tempering valve.
- The dishwasher must not be connected to an under sink high pressure “push through” type hot water system, as damage to the system will result.
- Ensure the bare wood surrounding the dishwasher is sealed with an oil-based paint or moisture-proof polyurethane to prevent possible steam damage.
- While installing a dishwasher, check the drain hose is not restricted or kinked.

Levelling

Before sliding the dishwasher into position, adjust the feet to ensure that the dishwasher is level at the required height. Check that the door opens and closes freely without resistance to adjacent cabinetry. If necessary adjust the levelling feet slightly. The dishwasher should not be inclined more than 2°. If the dishwasher is level it will help to ensure optimum performance.

Plumbing

Drainage

The recommended method of installation is shown in diagrams 1,2 and 3. The diagrams are designed to eliminate problems that occur with combined sink – dishwasher waste systems.

The standpipe must have a minimum diameter of 38 mm and stand 750mm above the floor. A drain hose support is provided to hold the drain hose in place in the standpipe (See diagrams 1 and 2). It is not recommended that the drain hose or drain pipe be connected directly to a waste disposal unit (see diagram 2).

When connecting the drain hose to a sink trap with a drain hose spigot, it is important that the drain hose is supported to the height of the bench (see diagram 3). Ensure the drain spigot has a minimum hole size of 15 mm and that it has been drilled out.

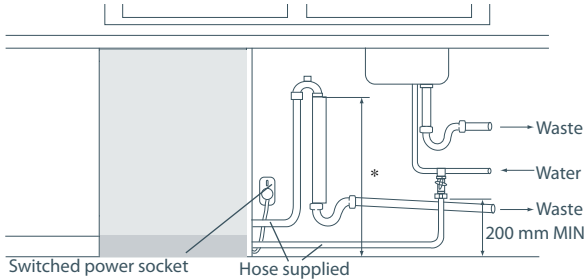

* Standpipe Ø38 mm
750 mm MIN above floor

Diagram 1: Dishwasher

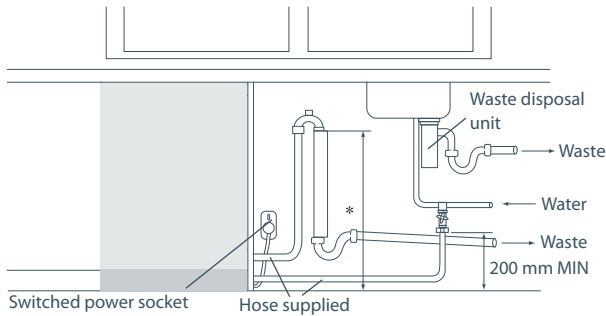

* Standpipe Ø38 mm
750 mm MIN above floor

note:
Connection of drain hose
direct to the waste disposal
unit is NOT recommended.

Diagram 2: Dishwasher & waste disposal unit

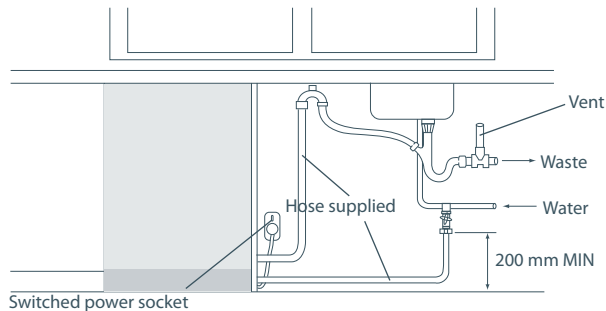

Diagram 3: Dishwasher using sink trap with dishwasher drain hose spigot

6 Installation instructions

Water inlet connections

The dishwasher has a single valve water connection. We recommend a cold water connection to give the best wash performance and energy efficiency.

Important!

The appliance should be connected to the water main using a new hose set. Old hose sets should not be used. If the water inlet hose is not long enough to make a proper connection, it must be replaced. This hose can be purchased from a Fisher & Paykel dealer or authorised service centre.

Water supply

The dishwasher inlet hose must be connected to an accessible water tap. The water supply to the dishwasher should be through a 3/4" bsp connector, making sure it is tightly fastened. The hose coupling must be tightened a further half turn after seal contact

If the water pipes have not been used for an extended period of time, let the water run to make sure that the water is clear and free of impurities. If this precaution is not taken, there is a risk the water inlet will get blocked and damage the appliance.

Anti-flood protection

This dishwasher has an anti-flood protection which will stop the water flowing in the event of a damaged hose or a leak within the machine.

Positioning your dishwasher

Position the appliance in the desired location. The water inlet and drain hoses can be positioned to the right or left to assist proper installation.

Underbench or built-in appliances should be installed under a continuous surface, which is attached to adjacent cupboards, in order to ensure that the appliance is stable.

The dishwasher may be installed with the top panel removed.

Electrical Connection

Ensure the voltage and frequency values for the current in your home correspond to those on the rating plate (located on the stainless steel inner door of your dishwasher), and that the electrical system is correct for the maximum voltage on the rating plate. Insert the plug into an electrical socket which is earthed properly (the earthing of the appliance is a safety requirement mandated by law).

If the electrical socket to which the appliance must be connected is not appropriate for the plug, replace the whole cable, rather than using adaptors as they could cause overheating and burns.

Important!

The dishwasher plug must be accessible even when the appliance is installed as a built-in unit so that maintenance can be done safely.

If a fault occurs

If the dishwasher malfunctions, turn off the water supply to the appliance and disconnect the plug from the wall socket. Refer to the Troubleshooting section. If you cannot solve the problem, contact a Fisher & Paykel Authorised Service Centre.

Specifications

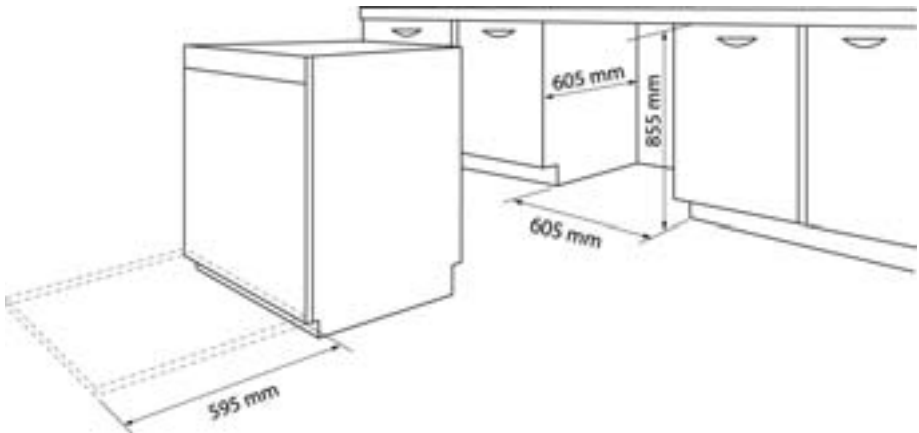

Model details

Model

DW60CSW2 / DW60CDW2
DW60CSX2 / DW60CDX2

Colour

White
Stainless steel

Technical Data

Width	600 mm
Depth	600 mm
Height	850 mm
Capacity	12 standard place settings
Mains water pressure	0.03 – 1 MPa (4.35 - 145 psi)
Power voltage	220-240 V - 50 Hz
Maximum current intensity	10 A
Total absorbed power	1950 W

8 Introducing your dishwasher

Dishwasher interior

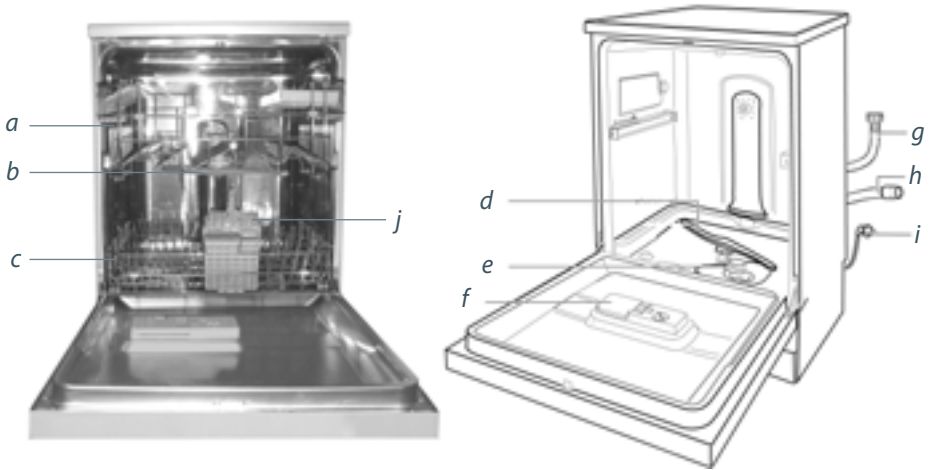
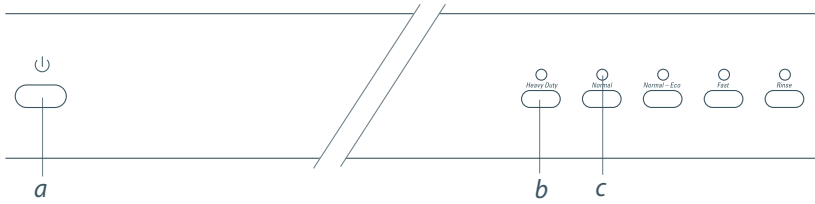

Fig. 1 Dishwasher interior

- a** Upper rack
- b** Top spray arm
- c** Lower rack
- d** Bottom spray arm
- e** Drain filter
- f** Detergent and rinse aid dispenser
- g** Water inlet hose
- h** Drain hose
- i** Power supply cord
- j** Cutlery basket



- a** Power button (ON/OFF)
- b** Programme button
- c** Programme indicator

Fig. 2 Control panel for DW60CS models

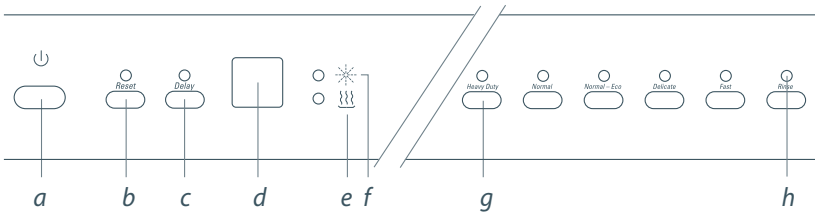

- a** Power button (ON/OFF)
- b** Reset button
- c** Delay start button
- d** Time remaining indicator
- e** Heater indicator
- f** Rinse aid indicator
- g** Programme button
- h** Programme indicator

Fig. 3 Control panel for DW60CD models

Quick start

- 1 Remove all food scraps and load the dishes.
- 2 Add detergent.
- 3 Check rinse aid.
- 4 Check that there is nothing obstructing the spray arms.
- 5 Close the door.
- 6 Press the Power button to turn the dishwasher on.
 - All the programme indicators will light up.
- 7 Press a programme button to select a wash programme.
 - After five seconds, the selected programme indicator light will start flashing, the dishwasher will beep once and the wash programme will start automatically. The Time remaining indicator will display the estimated time for the programme (DW60CD models only).

At the end of the wash programme, your dishwasher will beep six times, and all the programme indicators will light up.

- 8 Open the door and leave it slightly ajar to improve the drying performance.
- 9 After several minutes, press the Power button to turn the dishwasher off.
- 10 Remove dishes once they are cool enough to touch.

If you have forgotten to load some dishes

To pause a wash programme (DW60CD models only)

- 1 Press the Power button.
- 2 Open the door slowly.

Important!

There is a risk of being sprayed with hot water. Do not open the door fully until the spray arm has stopped rotating.

- If the door is left open during the wash programme, the dishwasher will beep ten times every thirty seconds.
- When the dishwasher has been paused and the dishwasher has heated the water, leave the door ajar for several minutes and then close. Otherwise, the dishwasher door may open due to expansion.

If you want to change or cancel a wash programme

A wash programme can be changed if it has only been running for a short time. The detergent dispenser may need to be refilled.

To cancel and reset a programme:

DW60CD models

Press the Reset button. One beep will sound, and all the programme indicators will light up to indicate that the current programme was cancelled successfully. You can now select a new wash programme.

DW60CS models

Press the Power button.

Memory function (DW60CD models only)

If the power supply is switched off during a programme, or the Power button is accidentally pushed, your dishwasher is able to remember the current setting and stage in the wash programme. It will automatically return to the same stage in the programme, once power is restored (or the Power button is set to 'ON'), and will continue with the wash.



If you want a programme to start later

Delay start (DW60CD models only)

This feature can delay the start of a wash programme from 1 to 12 hours. To activate the delay start:

- 1 Ensure you have loaded all the dishes, added detergent, and closed the door.
- 2 Turn your dishwasher ON.
- 3 Press the Delay start button. The Delay indicator will flash and the Time remaining indicator will change to '1h'.
- 4 Press and hold the Delay start button, until the Time remaining indicator shows the required delay.
- 5 Press a Programme button to select the desired programme.
- 6 Once the door is closed, after five seconds, the Time remaining indicator will flash and the dishwasher will begin to count down the time remaining. It will then start automatically after the selected time.

Note: to cancel the Delay Start setting, press the Reset button.

Selecting a wash programme

PROGRAMME	HEAVY DUTY	NORMAL	NORMAL ECO	DELICATE*	FAST	RINSE
<i>What load should I use it for?</i>	Heavily soiled pots, pans, and dishes.	Dishes with normal soils for optimum wash and dry performance.	Normally soiled dishes for optimum energy usage.	Lightly soiled delicate items.	Very lightly soiled mixed dishes.	Rinses dishes that have been stacked for several days in the dishwasher prior to washing.
<i>What stages does the programme consist of?</i>	Hot pre-wash	Cold pre-wash.	Cold pre-wash.	n/a	n/a	Short cold wash
	Main wash	Main wash	Main wash	Wash	Wash	
	Cold rinse	Cold rinse (x2)	Cold rinse	Cold rinse	Cold rinse	
	Hot rinse	Hot rinse	Hot rinse	Hot rinse	n/a	
	Drying	Drying	Drying	Drying	n/a	
	Hot rinse.	Hot rinse.	Hot rinse.			

*DW60CD models only

Wash times vary depending on incoming water temperatures, ambient conditions, type of dish load and whether the dishwasher has been opened during the wash. In DW60CD models, remaining wash times are only approximate on the display.

The combination of high temperatures and dishwasher detergent may cause damage to some items if they are washed in your dishwasher. Remember, if in doubt about any items to be washed in the dishwasher, follow the instructions from the manufacturer of the items, or wash them by hand.

Cutlery and silverware

All cutlery and silverware should be rinsed immediately after use to prevent tarnishing caused by some foods. The Rinse wash programme is useful for this. Silver items should not come into contact with stainless steel, for example other cutlery. Mixing these items can cause staining. Remove silver cutlery from the dishwasher and hand dry it immediately after the programme has finished.

Aluminium

Aluminium can be dulled by dishwasher detergent. The degree of change depends on the quality of the product.

Other metals

Iron and cast iron items can rust and stain other items. Copper, pewter and brass tend to stain.

Woodware

Wooden items are generally sensitive to heat and water. Regular use in the dishwasher may cause deterioration over time. If in doubt, wash by hand.

Glassware

Most everyday glassware is dishwasher safe. Crystal, very fine and antique glassware may etch (become opaque). You may prefer to wash these items by hand.

Plastic

Some plastic may change shape or colour with hot water. Check the manufacturer's instructions about washing plastic items. Washable plastic items should be weighed down so they do not flip over and fill with water, or fall through the basket during the wash.

Decorated items

Most modern china patterns are dishwasher safe. Antique items, those with a pattern painted over the glaze or gold rims, or hand painted china may be more sensitive to machine washing. If in doubt, wash these items by hand.

Glued items

Certain adhesives are softened or dissolved by machine washing. If in doubt, wash glued items by hand.

Never put highly absorbent materials, such as sponges and towels in your dishwasher.

Do not put dishes or cutlery that have been soiled by tobacco ash, wax, lubricating grease or paint in your dishwasher.

Dishwasher standards test

This dishwasher is tested to AS/NZS 2007 standards for both wash and dry performance. The following are loading pattern diagrams, detergent quantities and rinse aid quantities used for the dishwasher.

Wash programme	<i>Normal Eco</i>
Detergent quantities	<i>5 g prewash, +25 g main wash</i>
Rinse aid setting	5
Maximum place setting	12

Recommended loading pattern

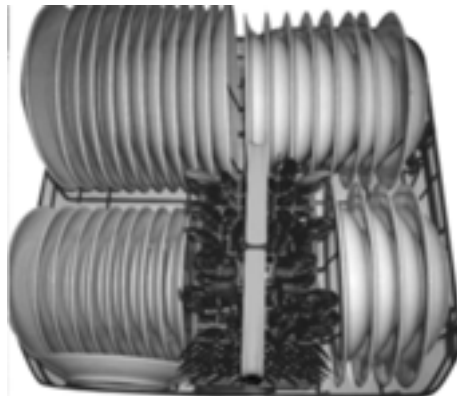

- The height-adjustable top basket must be in the uppermost position.
- When the programme is finished leave the door open 30° to improve the drying performance

Cutlery basket loading pattern

F	F	F	F	F			F	F	F	F	F
S		F	t	t	K	K	D		F		S
S		K	t	t	D	D	D	D		K	S
S	K		t	t	D	D	D	D	K		S
S		K	t	t	K	K	D	D		K	S
S		S		K			K		S		S

F = Fork

K = Knife

S = Tablespoon

D = Dessert spoon

t = Teaspoon

Take care when loading dishes to ensure that there is enough space and room for the water to reach all areas, particularly the cup racks. If there are any items blocking the spray arms' paths or the wash water, then the performance will be ineffective.

Before placing the dishes in the dishwasher, remove larger food particles to prevent the filter from becoming clogged.

If the pots and pans have baked-on food residue that is extremely hard to remove, we recommend that they are soaked before being washed. This will eliminate the need for extra wash cycles.

How to load the lower rack

The tines on the lower rack can be folded down so large items like pots and pans can be placed flat on the basket.

We recommend that you place the most difficult-to-clean items on the lower rack: pots, pans, lids, serving dishes and bowls.

Place serving dishes and lids on the sides of the racks to avoid blocking the rotation of the top spray arm.

The cutlery basket can be halved as shown in Fig 4 , so that you can use just one section when the cutlery load is light. This also makes space for additional pots and pans.

Place cutlery in the cutlery basket with the handles at the bottom. If you are using the anti-nesting grids, place spoons individually into the appropriate slots. Place long utensils in the horizontal position at the front of the upper rack. Place knives and other utensils with sharp points down, or in a horizontal position.



Fig. 4 Halving the cutlery basket

How to load the upper rack

The upper rack is designed to hold items like glasses, cups, saucers, plates, small bowls and shallow pans. Position these items so that they cannot be moved during the wash.

Upper rack adjustment for DW60CS models

- The upper rack can be adjusted for height by using the rollers located on both sides of the rack (see below).
- Adjusting the upper rack to a higher level will give you more space to accommodate taller items in the lower rack.

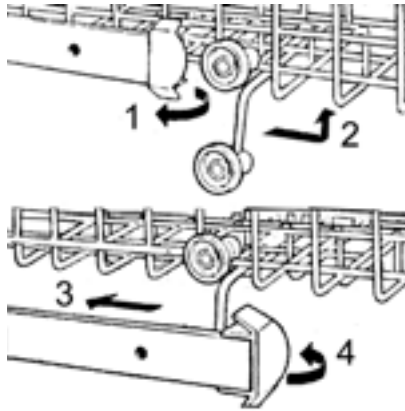

Fig. 5 Adjusting the upper rack for DW60CS models

Upper rack adjustment for DW60CD models

The upper rack can be adjusted for height using the levers located on both sides of the rack (see below).



Fig. 6 Adjusting the rack for DW60CD models

Important!

- *Never sprinkle or pour detergent directly onto any item in the dishwasher.*
- *Hand washing liquids, soap, laundry detergents or disinfectants will damage your dishwasher.*

Filling the detergent dispenser

- 1 Press the button on the top of the dispenser to open the cover.
- 2 Pour the detergent for the wash cycle into the larger main detergent compartment.
- 3 Pour the detergent for the pre-wash cycle into the smaller pre-wash detergent compartment.
- 4 Remove any excess detergent from the edges of the dispenser.
- 5 Close the cover and press down until it clicks into place.
The detergent will automatically be released into the dishwasher during the wash programme.

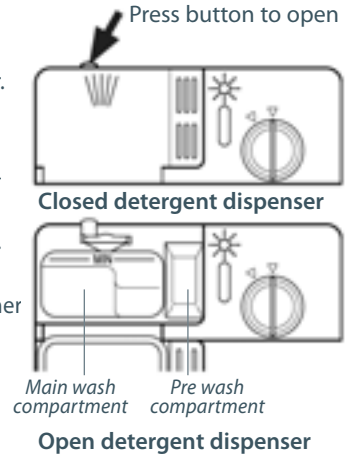
**Detergent quantities**

Wash programme	Detergent quantity	
	Pre-wash (g)	Main wash (g)
HEAVY DUTY	5	25
NORMAL	5	25
NORMAL ECO	5	25
DELICATE		15
FAST*		25
RINSE		

*available in DW60CD models only.

Important!

- *Dishwasher detergents are strongly alkaline and can be dangerous if swallowed.*
- *Avoid contact with skin and eyes.*
- *Keep children and infirm persons away from the dishwasher when the door is open.*
- *Check that the detergent receptacle is empty after the completion of the wash cycle – failure to do so could result in poisoning.*

We highly recommend the regular use of liquid rinse aid to give the best drying results. Rinse aid gives a streak-free, sparkling clean look to glass and chinaware. In addition it prevents metal from tarnishing. The rinse aid dispenser is located on the inside panel of the door.

Filling the rinse aid dispenser

- 1 Open the dispenser by turning the cap in an anticlockwise direction.

- 2 Pour the rinse aid into the dispenser, making sure not to overflow.

Take care not to spill rinse aid into the dishwasher. Any spills must be wiped up to prevent excess foaming. Failure to wipe up rinse aid spills may result in a service call, which will not be covered by warranty.

- 3 Fit the cap back in the original position.

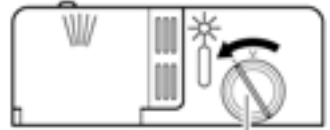

Fig. 7 Opening the rinse aid dispenser

How much rinse aid to use

The dose regulator may need to be adjusted to suit your water conditions. Regulate the amount of rinse aid by turning the dose regulator, using a screwdriver. The dose regulator is located underneath the rinse aid cap.

There are six dosage settings; the lowest setting is '1' and the highest setting is '6'. The normal dosage is setting '4'. If there is excessive foaming at the end of the wash, reduce the setting. If dishes are wet or streaky after drying, increase the setting.

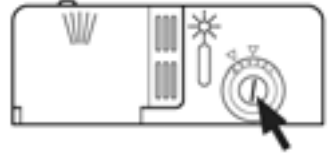

Fig. 8 Adjusting the dose regulator

Important!

If you are using dishwasher tablets that contain rinse aid, set the dose regulator to the lowest setting (1).

Too much rinse aid can lead to excessive foaming and may even damage the dishwasher.

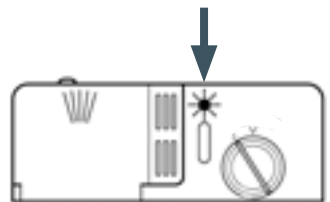

Fig. 9 Rinse Aid indicator light

Rinse Aid indicator light

When the rinse aid level becomes low, the Rinse Aid indicator will light up to remind you to refill the rinse aid. The Rinse Aid indicator light can be found on the detergent dispenser cover for all models, and on the exterior control panel for models DW60CDW2 and DW60CDX2.

After each wash, turn off the water supply to the dishwasher and leave the door ajar 30°, so that moisture and odours are not trapped inside.

Important!

The door should not be left in the fully open position as this could present a tripping hazard. Before cleaning or performing maintenance, always remove the power plug from the wall socket.

Cleaning the outer surfaces

From time to time the wash programme indicator panel and its surrounds need to be cleaned to remove food particles, and any spillages. We recommend wiping these areas with a clean, soft damp cloth, and drying them with a clean lint-free cloth.

Important!

We do not recommend the use of the following cleaning aids on your dishwasher, as they may damage the surfaces:

- *Plastic or stainless steel scouring pads.*
- *Abrasive, solvent house hold cleaners.*
- *Hand washing liquids or soaps.*
- *Laundry detergents or disinfectants.*

Cleaning the door seals

If food is trapped in the seals, then it can cause odours. Clean the seals periodically with a clean damp cloth to prevent this from happening.

Holiday time

If your dishwasher is not going to be used for some time, we recommend you ensure the baskets are empty. Leave the inside of the dishwasher clean. Leave the door ajar to allow air to circulate. Turn off both the power and water supply to your dishwasher.

Cleaning the drain filters and spray arms

Regular inspection and maintenance of your dishwasher helps to prevent problems from occurring. You should carefully inspect your dishwasher regularly. Check that no grease or scale has accumulated on the inside of your dishwasher. If you discover any deposits, clean them thoroughly with warm water on a soft, lint-free cloth.

Filters

The filters A and B prevent larger particles of food in the water from reaching the pump. These particles may occasionally block the filters. We recommend that the drain filter is cleaned whenever there is evidence of food particles.

- When the dishwasher has finished washing, check the filters for particles of food and, if required, clean.
- After removing the coarse micro-filter (filter A), the filter unit (filter B) can be removed. Remove any particles of food and rinse the filters under running water.
- Replace the filter unit (B) and then the coarse micro-filter (A). Ensure that the micro-filter is tightened firmly.

Spray arms

Lime and remnants of food in the wash water can block the nozzles in the spray arms and the arm mountings. The spray arms and mountings may need cleaning about once a month in normal use or more often should the need arise:

- Inspect the nozzles in the spray arms for blocked holes.
- If necessary, unscrew the lower arm (C) and lift it off. Unscrew the upper spray arm (D).
- Clean both spray arms under running water.
- Refit the spray arms. Ensure that the lower spray arm is locked into place and the upper one is screwed tightly.

Important!

The dishwasher must be used with the filter plate, drain filter and spray arms correctly in place. Where there is broken crockery or glass in the dishwasher, carefully and immediately remove it to prevent damage.

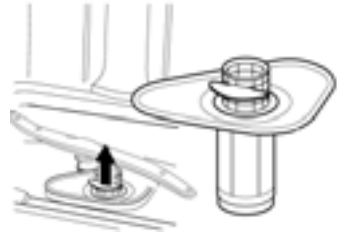

Fig. 10 Removing the micro-filter (Filter A)

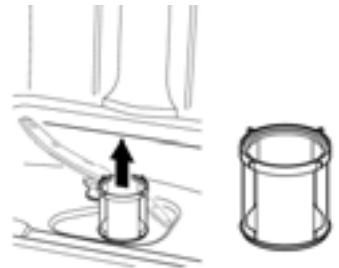

Fig. 11 Removing the filter unit (Filter B)

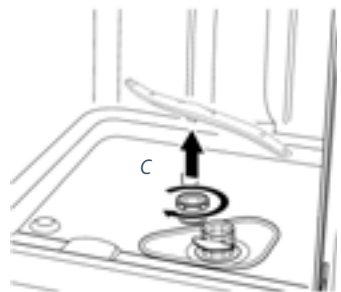
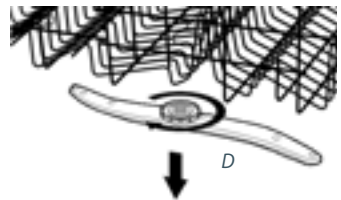

Fig. 12 Removing the spray arms (C and D)

Please read the following pages before you call for service.

You can correct many of your dishwasher's problems yourself, using the checklists on the following pages.

Fault signal	Fault code	Possible causes	What to do
First 2 programme indicators flashing	E1	The door is not properly closed.	Close the door firmly.
1 and 3 programme indicator lights flashing	E2	Temperature sensor faulty	Turn the water and power off to the dishwasher. Call your Fisher & Paykel dealer or Authorised Service Centre.
1 and 4 programme indicator lights flashing	E3	Drain hose is too low. The wash water level is too low.	Ensure that drain hose is connected in accordance with the 'Installation instructions'.
Programme indicators 1, 3 and 4 flashing	E4	Drain hose is crimped or bent. The wash water is not draining out. Drain hose is too high.	Check hose and straighten if needed. Ensure that drain hose is connected in accordance with the 'Installation instructions'.
First 3 programme indicators flashing	E5	Water tap not turned on. Insufficient water supply pressure. Water supply hose is crimped or bent. Drain hose is too low.	Ensure the water is connected and turned on. Check household water pressure. Check hose and straighten if needed. Ensure that drain hose is connected in accordance with the 'Installation instructions'.
First 4 programme indicators flashing	E6	Flood switch activated.	Turn the water off and the mains power off to the dishwasher. Call your Fisher & Paykel dealer or authorised service centre.

If the dishwasher still will not work, or shows any other error display:

- Power the dishwasher OFF and wait for a few minutes.
- Power the dishwasher ON and retry.

If the dishwasher still does not function, and/or the problem persists, contact your Fisher & Paykel Dealer or Authorised Service Centre with the fault code/signal information.

22 Troubleshooting

Problem	Probable cause	What to do
Dishwasher will not start.	Power supply is not connected.	Connect the power supply.
	The door is not properly closed.	Close the door.
	Programme button has not been pressed.	Select a programme.
	Water tap not turned on.	Ensure the water is connected and turned on.
	Blocked strainer in water intake hose.	Check strainer – located in the inlet supply hose where it screws into the tap.
Lower spray arm rotates with difficulty.	Spray arm is blocked by small items or food remains.	Clean spray arm.
Lid of detergent dispenser cannot be closed.	Detergent compartment has been overfilled.	Remove detergent until the lid can be closed.
	Detergent dispenser is clogged with remnants of detergent.	Wipe dispenser out with a damp cloth. Dry before adding detergent.
Remnants of detergent stuck inside dispenser.	Compartment was damp when filled with detergent.	Wipe dispenser out with a damp cloth. Dry before adding detergent.
Indicator lights do not extinguish after washing has finished.	Power button is ON.	Turn the Power button off.
Water remains inside dishwasher after wash has ended.	Drain hose is crimped, bent or blocked.	Check hose and straighten if needed.
	Pump is jammed.	Call your Fisher & Paykel Authorised Service Centre.
	Filter/s blocked.	Clean the filter/s.
	The wash is still running.	Wait for the programme to end.
Foaming.	Incorrect amount/type of detergent used.	See the 'Detergent' section or consult the detergent manufacturer's instructions.
	Too much egg in the wash load.	Increase the amount of detergent.
	Rinse aid setting too high.	Decrease the rinse aid setting.
	Rinse aid spills not wiped up.	Ensure that all rinse aid spills are wiped up when they occur.
Stops suddenly during wash.	Power supply has been interrupted.	Check power supply.
	Water supply has been interrupted.	Check water supply.



Problem	Probable cause	What to do
Knocking or rattling sound during wash.	Spray arm knocking against dishes.	Stop cycle and reposition dishes.
	Dishes have been stacked incorrectly.	Stop cycle and reposition dishes.
Unclean dishes.	Wash programme unsuitable for load or soils were too heavily baked on and dishes may need soaking.	See the 'Wash programme chart' for a suitable wash programme.
	Spray arm unable to rotate.	Ensure no items are obstructing the spray arm path.
	Dishwasher overloaded/ incorrectly loaded.	See the 'Loading' section.
	The filters are incorrectly inserted.	See the 'Care and cleaning' instructions.
	Detergent put in the wrong compartment.	Put detergent in the large (main wash) compartment.
	Excessive food not removed from dinnerware prior to cleaning.	Scrape all food scraps off dinnerware prior to loading.
	Unsuitable detergent.	Use recommended brands of dishwasher detergent.
	Not enough detergent.	See the 'Detergent' section or the detergent manufacturer's instructions.
Plastic items are discoloured.	Spray arm holes are blocked.	Clean the spray arm.
	The filters are blocked.	Clean the filters.
Plastic items are discoloured.	Not enough detergent.	Pre-rinse dishes before placing in the dishwasher. Alternatively, using the rinse programme after adding dishes may minimise staining.
White stains are left on dishes; glasses have a milky appearance.	Not enough detergent.	See the 'Detergent' section or the detergent manufacturer's instructions.
	Rinse aid set too low.	Increase rinse aid dose setting.
Dishes, cutlery have not dried.	Selected programme did not include drying function.	Select wash programme with drying function.
	Rinse aid set too low.	Increase rinse aid setting. See the 'Rinse aid' section.
	Items removed too soon.	Wait until dishwasher beeps to indicate the end of the programme.



Problem	Probable cause	What to do
Glasses have dull appearance.	Rinse aid set too low.	Increase rinse aid setting. See the 'Rinse aid' section.
Tea stains or traces of lipstick have not been completely removed.	Not enough detergent.	See the 'Detergent' section or the detergent manufacturer's instructions.
	Wash temperature too low.	Select wash programme with higher temperature.
Traces of rust on cutlery.	Cutlery is not sufficiently rust proof.	Wash by hand.
Glasses clouded and discoloured; coating cannot be removed.	Unsuitable detergent.	Use recommended brands of dishwasher detergent.
	Glasses are not dishwasher proof.	Wash by hand.
Smears left on glasses and cutlery.	Rinse aid set too high.	Reduce rinse aid setting. See the 'Rinse aid' section.



Manufacturer's warranty

When you purchase any new Fisher & Paykel whiteware Product you automatically receive a two year Manufacturer's Warranty covering parts and labour for servicing.

Fisher & Paykel undertakes to

Repair or, at its option, replace without cost to the owner either for material or labour any part of the Product, the serial number of which appears on the Product, which is found to be defective within TWO YEARS of the date of purchase.

This warranty DOES NOT cover

- A Service calls which are not related to any defect in the Product. The cost of a service call will be charged if the problem is not found to be a Product fault. For example:
 1. Correct the installation of the product.
 2. Instruct you how to use the product.
 3. Replace house fuses or correct house wiring or plumbing.
 4. Correcting fault(s) caused by the user.
- B Defects caused by factors other than:
 1. Normal domestic use or
 2. Use in accordance with the Product's User Guide.
- C Defects to the Product caused by accident, neglect, misuse or Act of God.
- D The cost of repairs carried out by non-authorized repairers or the cost of correcting such unauthorised repairs.
- E Normal recommended maintenance as set out in the Product's User Guide.
- F Repairs when the appliance has been dismantled, repaired or serviced by other than a Fisher & Paykel AUTHORISED SERVICE CENTRE or the selling dealer.
- G Pick up and delivery.
- H Transportation or travelling costs involved in the repair when the product is installed outside the Fisher & Paykel AUTHORISED SERVICE CENTRE'S normal service area.

Service under this manufacturer's warranty must be provided by an Authorised Service Agent (refer to the Customer care section for contact details). Such service shall be provided during normal business hours. This warranty certificate should be shown when making any claim.

Note:

This Warranty is an extra benefit and does not affect your legal rights and applies only to product purchased in Australia and Singapore.

*Please keep this User Guide in a safe place.
Do not return to Fisher & Paykel.*

Customer care



Check the things you can do yourself. Refer to your User Guide and check:

- 1 your appliance is correctly installed
- 2 you are familiar with its normal operation

If after checking these points you still need assistance please refer to the following:

In Australia If you need assistance call...*

Call the Fisher & Paykel Customer Care Centre and talk to one of our Customer Care Consultants.

Toll Free - 1300 650 590

Fax: (07) 3826 9298

Email: customer.care@fp.com.au

Postal Address: PO Box 798, Cleveland QLD 4163

If you need service...*

Fisher & Paykel Australia Pty Ltd has a network of independent Fisher & Paykel Authorised Service Centres whose fully trained technicians can carry out any service necessary on your appliance. Our Customer Care Centre can recommend an Authorised Service Centre in your area.

In Singapore If you need assistance...*

Call your Fisher & Paykel retailer who is trained to provide information on your appliance, or if we can be of any further help, please contact our Customer Care Centre,

Tel: +65 6741 0777

Fax: +65 6547 0123

Email: customer.service@fisherpaykel.com.sg

Postal address: Singapore Fisher & Paykel (Singapore) PTE Ltd.

150 Ubi Avenue 4

Sunlight Building #02-00

Singapore 408825

*If you call or write, please provide: name, address, model number, serial number, date of purchase and a description of the problem. This information is needed in order to better respond to your request for assistance.







Copyright © Fisher & Paykel 2008. All rights reserved.

The product specifications in this booklet apply to the specific products and models described at the date of issue. Under our policy of continuous product improvement, these specifications may change at any time. You should therefore check with your Dealer to ensure this booklet correctly describes the product currently available.

www.fisherpaykel.com.au

www.fisherpaykel.com.sg

AU SG

Dishwasher user guide

Published: 08/2008

Part No. 599613 A