

AC INFINITY

CLOUDFORGE

ENVIRONMENTAL HUMIDIFIER

USER MANUAL



WELCOME

Thank you for choosing AC Infinity. We are committed to product quality and friendly customer service. If you have any questions or suggestions, please don't hesitate to [contact](#) us. Visit www.acinfinity.com and click contact for our contact information.

EMAIL

support@acinfinity.com

WEB

www.acinfinity.com

LOCATION

Los Angeles, CA

MANUAL CODE CF2311X1

PRODUCT

CLOUDFORGE T3
CLOUDFORGE T5
CLOUDFORGE T7
CLOUDFORGE T9

MODEL

AC-CFT3
AC-CFT5
AC-CFT7
AC-CFT9

UPC-A

819137023611
819137023635
819137023628
819137023642

MANUAL INDEX

Manual Index	Page 5
Product Warning	Page 6
Key Features	Page 7
Product Contents	Page 8
Installation	Page 9
Powering and Setup	Page 16
UIS™ Platform	Page 20
Connecting to UIS™ Controllers	Page 21
Cleaning	Page 22
Programming	Page 24
Other Settings	Page 35
Other AC Infinity Products	Page 37
Warranty	Page 38

PRODUCT WARNING



TO REDUCE THE RISK OF FIRE, ELECTRIC SHOCK, OR INJURY TO PERSONS, OBSERVE THE FOLLOWING:

1. Ensure your power source conforms to the electrical requirements of this product.
2. Read all instructions before installing and using this product.
3. Only use distilled water, and do not pour water into the central pipe. This will prevent your humidifier from functioning properly.
4. Do not attempt to hardwire this product. Performing any retrofitting actions may result in personal injury and/or electrical damage, and will void this product's warranty.
5. Be careful not to damage or cut the wire insulation (covering) during the installation. Do not permit wires to come in contact with any sharp edges.
6. This product must not be used or placed in potentially hazardous locations such as flammable, explosive, electrical, or chemical-laden atmospheres.
7. Do not cover any power cords with rugs or other fabric materials.
8. Safety precautions should be exercised during the installation, operation, and maintenance of this product.
9. Do not block or tamper with this product in any manner while it is in operation as it may cause electric shock, fire, or damage to this product.
10. Do not depend on the on/off programming as the sole means of shutting power from this product. Unplug the power cord before installing, servicing, or moving this product.
11. Do not operate this product while its cord is damaged, or if it malfunctions, has been dropped, or is damaged in any manner.

KEY FEATURES

TARGETED ZONE

Includes a directional cap and stretchable tube, or pipe and nozzles, for various humidity distribution methods in spaces like grow tents, DIY grow rooms, living spaces, and greenhouses.

PRECISION DETECTION

Swiss-made thermal alloy sensor with a waterproof gasket made of SAE grade-316 steel detects humidity changes and provides up-to-the-minute readings. Extension cord enables detection in spot areas and convenient humidifier placement.

SMART CONTROLLER

Onboard controller with LED touch interface featuring humidity balance programming. Pair with UIS controllers to access intelligent programming and app control with advance automation and data charts.

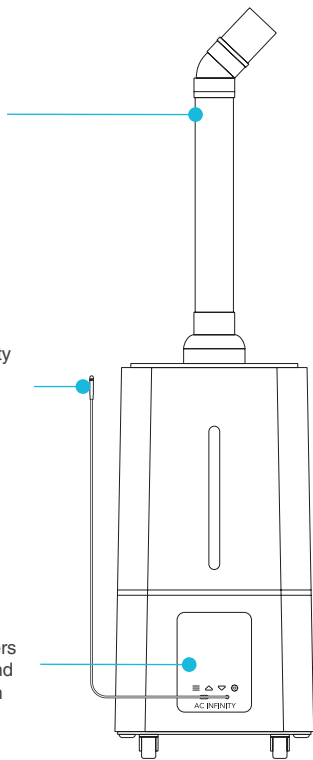
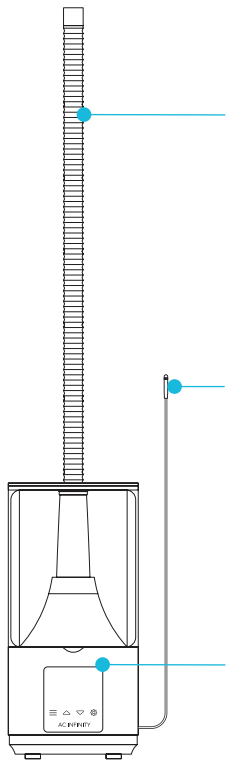

PRODUCT CONTENTS

CLOUDFORGE T3



4.5L
HUMIDIFIER
(x1)



FLEXIBLE
HOSE
(x1)

CLOUDFORGE T7



15L
HUMIDIFIER
(x1)



PIPE
BASE
(x1)



PVC
PIPE
(x1)



FLEXIBLE
HOSE
(x1)



ELBOW
NOZZLE
(x1)



5-WAY
NOZZLE
(x1)



ELASTIC
BANDS
(x4)

ALL MODELS

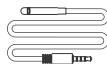

SENSOR
PROBE
(x1)

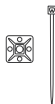

PROBE
MOUNT
(x1)

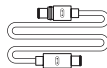

UIS EXTENSION
CORD (M-M)
(x1)



NEBULIZER
BRUSH
(x1)



HOOK AND
LOOP TIE
(x1)

INSTALLATION

CLOUDFORGE T3

STEP 1

Add water into the tank. You may detach the tank to fill it with water.

We recommend using distilled water to reduce the amount of mineral build-up.

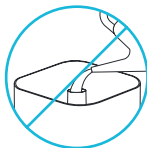
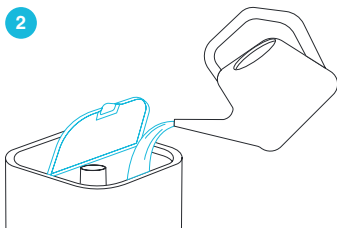

NOTE: Do NOT pour water into the central pipe. This will prevent your humidifier from functioning properly.

INSTALLATION

CLOUDFORGE T3

STEP 2

You may swap the directional flow cap with the included flexible hose for extended targeted flow.

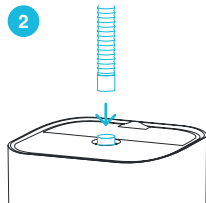
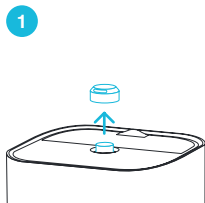

INSTALLATION

CLOUDFORGE T3

ROUTING THE HOSE

Do not bend the hose in a U-shape. Doing so will result in water pooling, which will spill into puddles and block humidity from emitting. This will also result in water flowing back into the base, which can overflow it and cause leakage.

In addition, make sure the hose is sloped upwards when routing it to your grow tent. Sloping the hose downward will result in condensation building up in the hose. This may further result in water dripping out and creating a puddle.

Dry the hose after each use.

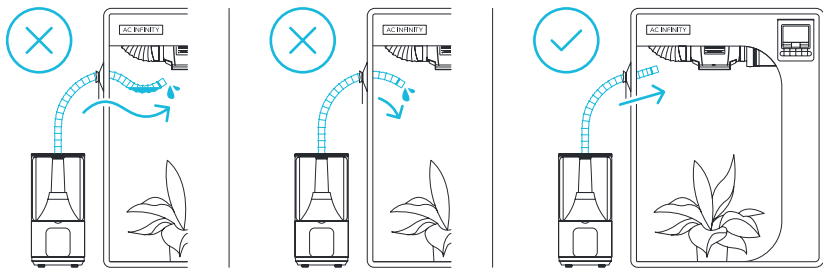

INSTALLATION

CLOUDFORGE T7

STEP 1

Add water into the tank. You may detach the tank to fill it with water.

We recommend using distilled water to reduce the amount of mineral build-up.

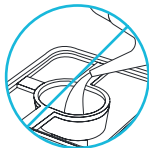
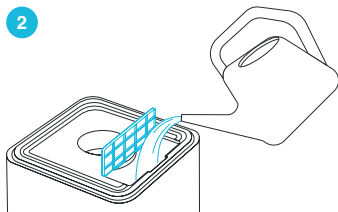
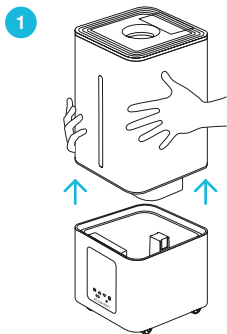

NOTE: Do NOT pour water into the central pipe. This will prevent your humidifier from functioning properly.

INSTALLATION

CLOUDFORGE T7

STEP 2

Top the center lid opening with the included base.

You may install either the included hose or pipe to extend the reach of your humidifier.

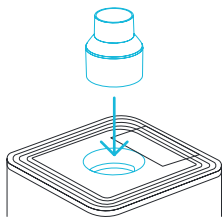

STEP 3 — PIPES

Attach the pipe into the base, followed by your choice of nozzle:

- Elbow nozzle* for unidirectional flow
- 5-way nozzle for omnidirectional flow

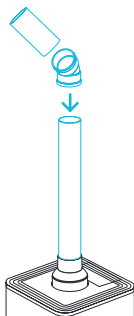

OR

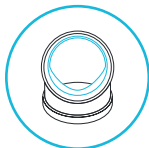
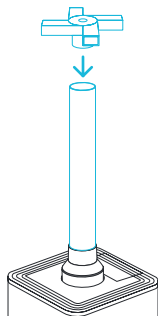

*Make sure the elbow nozzle is placed over the pipe with the interior ridge facing the ground.

INSTALLATION

CLOUDFORGE T7

USING YOUR OWN PIPES

You may use your own PVC pipes to extend the reach of your humidifier.

Line the pipe with the included elastic band and attach it to the base or elbow nozzle.

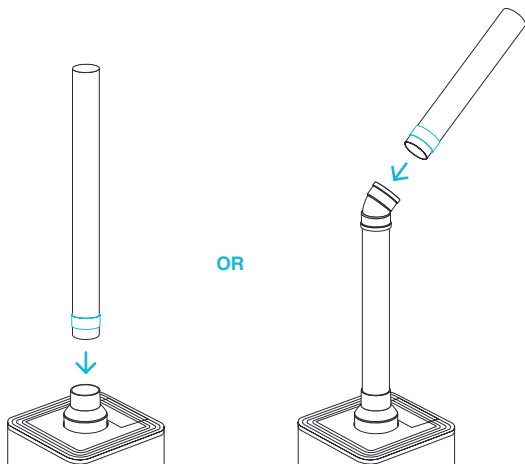
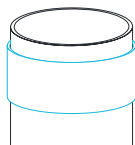

INSTALLATION

CLOUDFORGE T7

STEP 3 — HOSE

Attach the flexible hose to the base for targeted flow.

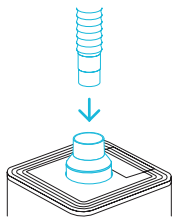

ROUTING THE HOSE

Do not bend the hose in a U-shape. Doing so will result in water pooling, which will spill into puddles and block humidity from emitting. This will also result in water flowing back into the base, which can overflow it and cause leakage.

In addition, make sure the hose is sloped upwards when routing it to your grow tent. Sloping the hose downward will result in condensation building up in the hose. This may further result in water dripping out and creating a puddle.

Dry the hose after each use.

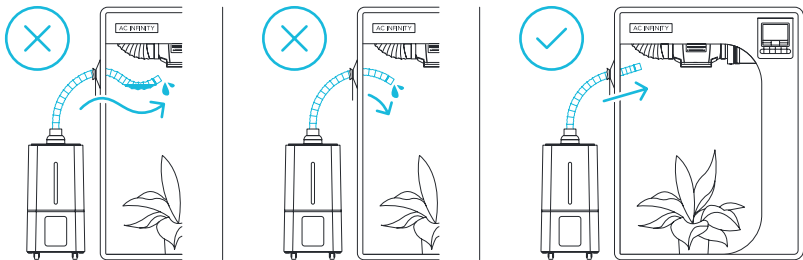

POWERING AND SETUP

CLOUDFORGE T3

STEP 1

Plug the sensor connector with the gasket into the 3.5mm jack located at the rear side.

The gasket is specially designed to protect against liquids and dust.

Route the probe head to spot areas as needed.

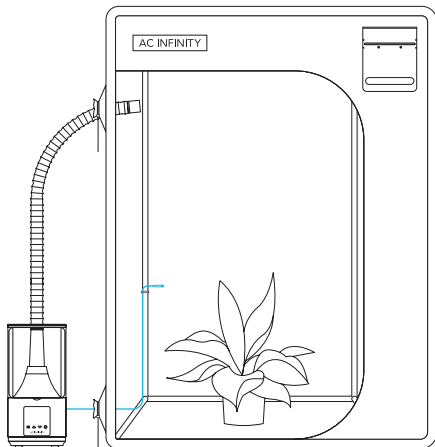
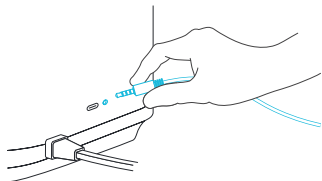

POWERING AND SETUP

CLOUDFORGE T3

STEP 2

You may plug the included UIS extension cord into the rear side port to connect your humidifier to your UIS controller.

Plug the UIS connector with the gasket end into your humidifier. The gasket is specially designed to protect against liquids and dust.

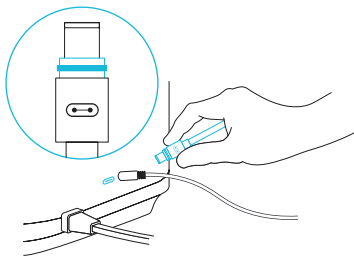

STEP 3

Plug your humidifier's power plug into an outlet to power it.

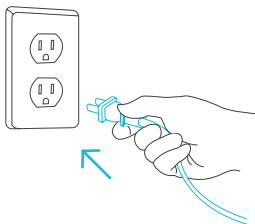

POWERING AND SETUP

CLOUDFORGE T7

STEP 1

Plug the sensor connector with the gasket into the 3.5mm jack located below the display screen.

The gasket is specially designed to protect against liquids and dust.

Route the probe head to spot areas as needed.

You may also use the included probe mount to cable manage the corded probe.

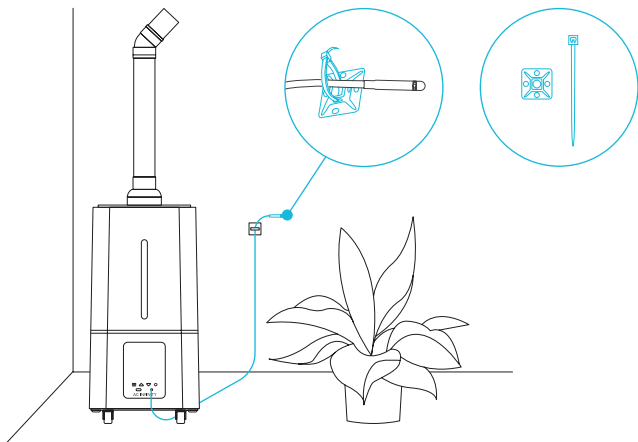
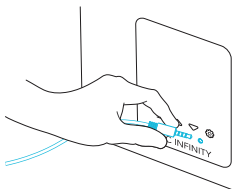

POWERING AND SETUP

CLOUDFORGE T7

STEP 2

You may plug the included UIS extension cord into the front side port to connect your humidifier to your UIS controller.

Plug the UIS connector with the gasket end into your humidifier. The gasket is specially designed to protect against liquids and dust.

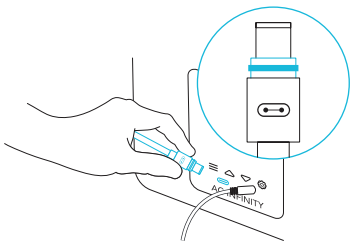

STEP 3

Plug your humidifier's power plug into an outlet to power it.

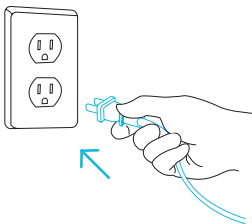

UIS™ PLATFORM

The UIS™ platform enables you to connect a single central controller with several grow devices simultaneously. By creating this fully integrated system, you can power and program all your devices together or separately for optimized grow tent management.

Your grow system can be regulated using your controller hub or remotely on the AC Infinity app (paired with compatible controllers), where you will have access to automation programming and climate data.

You can also connect your favorite grow light and outlet device to integrate them into the UIS platform using our RJ11/12 adapter and control plug module.

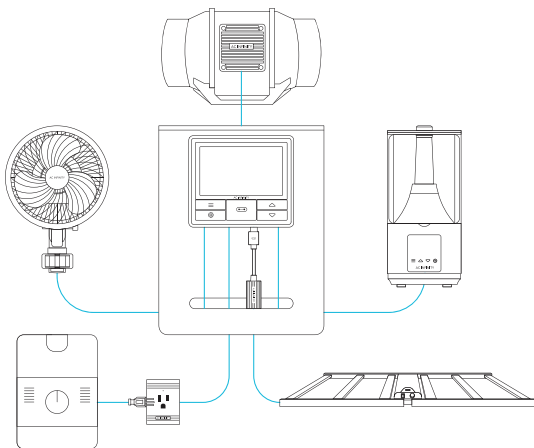

Grow devices will be sold separately and may still be in development at the time of your purchase of this product.

CONNECTING TO UIS™



CLOUDFORGE humidifiers can connect with CONTROLLER 69 PRO (sold separately) as part of an integrated system using the included UIS extension cord.

EXTENSION CABLE

Use the included UIS M-M extension cord to connect your humidifier to your CONTROLLER 69 PRO unit.

Plug the UIS connector with the gasket end into your humidifier. The gasket is specially designed to protect against liquids and dust.

Your CONTROLLER 69 PRO unit will override all on-board settings, assume control (parameters must be adjusted on CONTROLLER 69 PRO), and shut off your humidifier's display and touch functions when connected in this manner.

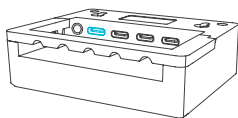
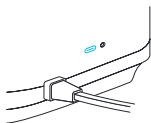
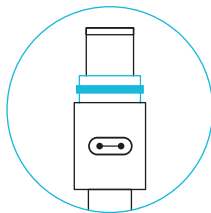

CLEANING

Exchange the water in the reservoir at least once every 4 days. Clean and maintain your humidifier and its filter piece* at least once a week. The filter piece is used to catch any debris or particles that may be in the water.

STEP 1

Unplug your humidifier and remove the tank from the base.

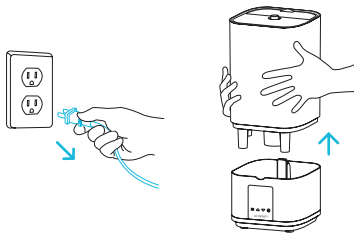

STEP 2

Pour out any water sitting in the base. Pour two cups of distilled water and one tablespoon of vinegar into the base. Let it sit for five minutes.

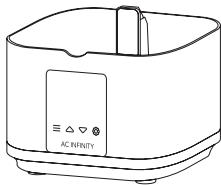

*CLOUDFORGE T3 ONLY

CLEANING

STEP 3

Use the included brush to remove any build-up from the nebulizer(s).

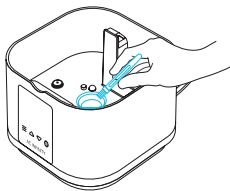

STEP 4

Pour out the vinegar water mixture and wipe the base dry. Replace the tank to finish.

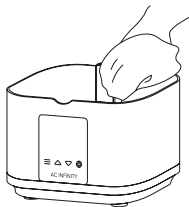

WATER FILTER — CLOUDFORGE T3 ONLY

Remove the filter from the tank and soak it in two cups of distilled water and one tablespoon of vinegar for 5 minutes.

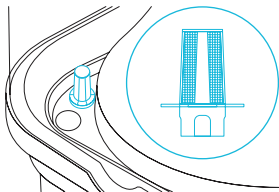

PROGRAMMING

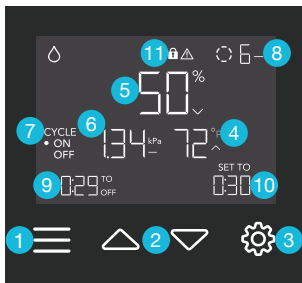

Screen shown: CLOUDFORGE T3

1. MODE BUTTON

Cycles through the controller's modes: OFF, ON, AUTO (1 trigger), VPD (1 trigger), TIMER (to OFF), CYCLE (ON and OFF).

4. PROBE TEMPERATURE

Displays the current temperature that the probe is measuring. Shows "--" if no probe is plugged in.

7. CURRENT MODE

Displays the controller's current mode. Pressing the mode button cycles through the available modes.

10. USER SETTING

Displays the value of your current mode. Use the up or down buttons to adjust the value.

2. UP/DOWN BUTTONS

Adjusts the value of your current mode. The up button increases and down button decreases the setting. Hold both to reset values to OFF/Default.

5. PROBE HUMIDITY

Displays the current humidity that the probe is measuring. Shows "--" if no probe is plugged in.

8. CURRENT LEVEL

Displays your humidifier's current moisture level.

11. ALERT ICONS

Displays alerts and statuses of the onboard controller, including the controller lock, CLIMATE alert, and TIMER alert.

3. SETTING BUTTON

Cycles through the controller's settings: °F / °C, CALIB. T° / H% / kPa, and LEAF OFFSET.

6. PROBE VPD

Displays the current VPD that the probe is measuring. Shows "--" if no probe is plugged in.

9. COUNTDOWN

Displays the countdown of the TIMER or CYCLE modes that activates or deactivates your humidifier. TO ON shows the amount of time left before your humidifier turns on. TO OFF shows the amount of time left before your humidifier turns off.

PROGRAMMING

HUMIDIFIER MODES

Tap the mode button will cycle through the controller's available programming modes: OFF, ON, AUTO (1 trigger), VPD (1 trigger), TIMER (ON and OFF), and CYCLE (ON and OFF).

OFF MODE

Your humidifier will not run while in this mode. The OFF Mode setting also serves as the minimum level the other modes will run at while triggered OFF.

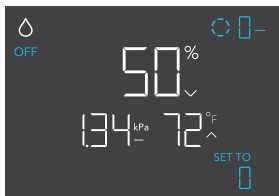

Screen shown: CLOUDFORGE T3

MINIMUM LEVEL

Your humidifier will run at the level set in OFF Mode, as the minimum level, when triggered to turn OFF. These other modes include the AUTO Mode, CYCLE Mode, and TIMER Mode.

It will run continuously until triggered ON, at which point it will run at the level set in ON Mode.

If you want your humidifier to turn off completely when it's triggered to be OFF, set the OFF Mode level to zero.

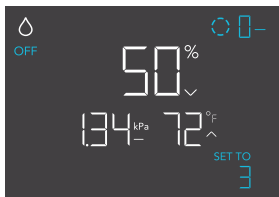

Screen shown: CLOUDFORGE T3

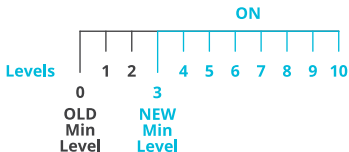

PROGRAMMING

ON MODE

Your humidifier will actively run at the level set here, regardless of the probe's reading. The ON Mode setting also serves as the maximum level the other modes will run at.

MAXIMUM LEVEL

Your humidifier will run at the level set in ON Mode, as the maximum level, when triggered ON, as well as in the AUTO Mode, CYCLE Mode, and TIMER Mode.

Do not set the ON Mode figure to zero or your humidifier will turn off when it's triggered ON in all modes.

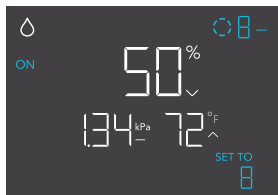

Screen shown: CLOUDFORGE T3



PROGRAMMING

AUTO MODE (LOW HUMIDITY TRIGGER)

The AUTO Mode sets the low humidity trigger. Your humidifier will activate if the probe's reading falls below this threshold.

Once triggered, your humidifier will ramp up to the level set in ON Mode. If the probe's reading rises above this trigger point, your humidifier will stop emitting vapors.

Leaving the AUTO Mode while it is active will pause it until you return to this mode.

If there is a level set in OFF Mode other than zero, your humidifier will run at that level when triggered to turn off.

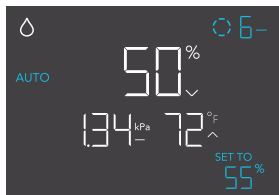

Screen shown: CLOUDFORGE T3

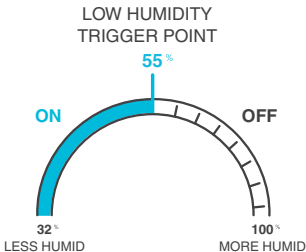

PROGRAMMING

VPD MODE (HIGH VPD TRIGGER)

The VPD Mode sets the high VPD trigger. Your humidifier will activate if the probe's reading meets or exceeds this threshold.

Once triggered, your humidifier will gradually ramp up to the level set in ON Mode. If the probe's reading falls below this trigger point, your humidifier will gradually slow down to a stop or at the level set in OFF Mode.

Leaving the VPD Mode while it is active will pause it until you return to this mode.

If there is a level set in OFF Mode other than zero, your humidifier will run at that level when triggered to turn off.



Screen shown: CLOUDFORGE T3

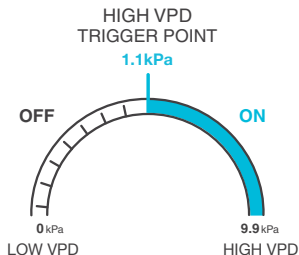

PROGRAMMING

TIMER MODE (TO OFF)

The TIMER Mode sets a countdown time. Your humidifier will run at the level set in ON Mode until the countdown ends.

The countdown will begin if no buttons are tapped for 3 seconds.

Leaving the TIMER Mode while the countdown is running will pause it until you return to this mode.

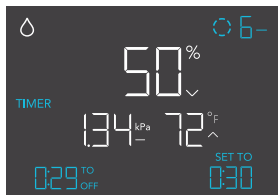

Screen shown: CLOUDFORGE T3

If there is a level set in OFF Mode other than zero, your humidifier will run at that level when triggered to turn off.

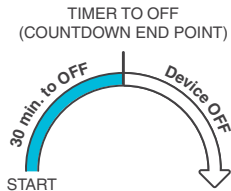

PROGRAMMING

CYCLE MODE (ON AND OFF)

The CYCLE Mode sets an on duration and an off duration for your humidifier to cycle through continuously. Press the up or down button to first set a duration for your humidifier to activate. Then press the mode button again and set a duration for your humidifier to deactivate.

When your humidifier is activated, it will run at the level set in ON Mode. When your humidifier is deactivated, it will run at the level set in OFF Mode.

The countdown will begin if no buttons are pressed for 5 seconds. Leaving the CYCLE Mode while the countdown is running will pause it until you return to this mode.

If there is a level set in OFF Mode other than zero, your humidifier will run at that level when triggered to turn off.

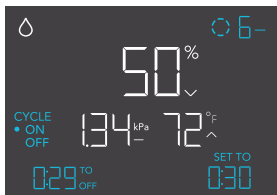

Screen shown: CLOUDFORGE T3

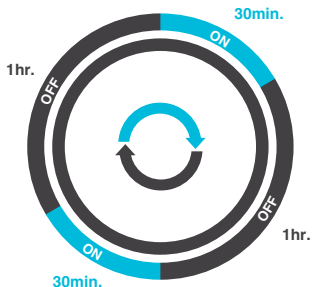

PROGRAMMING

CONTROLLER SETTINGS

Pressing the setting button will cycle through the controller's available settings: °F / °C, CALIB. T° / H% / kPa, and LEAF OFFSET.

°F/°C SETTING

Changes the displayed units to Fahrenheit or Celsius. Press the up or down button to cycle through F and C. All displayed units will automatically convert when adjusting this setting.

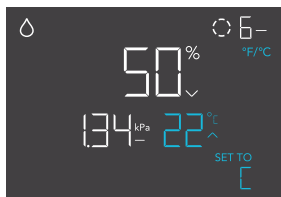

Screen shown: CLOUDFORGE T3

CALIBRATION TEMPERATURE SETTING

Adjusts the temperature reading the sensor probe is measuring. Press the up or down button to increase or decrease the data figure in 1° increments. The calibration cycle ranges from -20°F to 20°F (or -10°C to 10°C) and will be applied to the sensor probe's measurements.

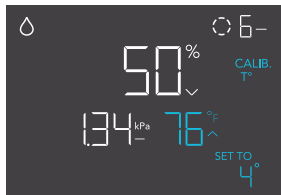

Screen shown: CLOUDFORGE T3

PROGRAMMING

CALIBRATION HUMIDITY SETTING

Adjusts the relative humidity reading the sensor probe is measuring. Press the up or down button to increase or decrease the data figure in 1% increments. The calibration cycle ranges from -10% to 10% and will be applied to the sensor probe's measurements.

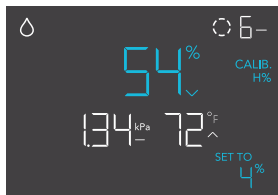

Screen shown: CLOUDFORGE T3

CALIBRATION LEAF OFFSET SETTING

Adjusts the VPD reading the sensor probe is measuring. Press the up or down button to increase or decrease the data figure in 1° increments. The calibration cycle ranges from -20°F to 20°F (or -10°C to 10°C) and will be applied to the sensor probe's measurements.

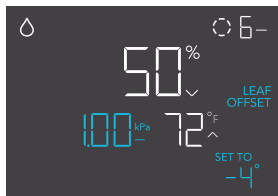

Screen shown: CLOUDFORGE T3

PROGRAMMING

ALERT ICONS

The alert icons are displayed at the top of the screen and will flash when the controller signals an alert, notifying you of any triggered functions or alarms.

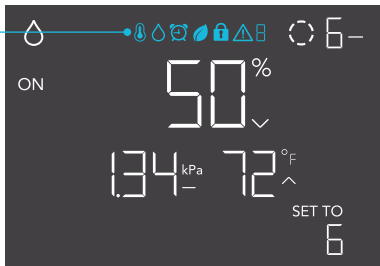

Screen shown: CLouDFORGE T3



WATER LEVEL LOW

Displays whenever the water level is low. Your humidifier will pause programming and its screen will flash until its tank is replenished. Please note lifting the tank will also trigger this alert icon, disappearing when you put the tank back in place.



FAIL-SAFE

Displays whenever your humidifier falls or is tilted past a 20° angle. Your humidifier will pause programming and its screen will flash until it is back to an upright position.



AUTO MODE ALERT

Flashes whenever the AUTO Mode trigger activates your humidifier.

PROGRAMMING

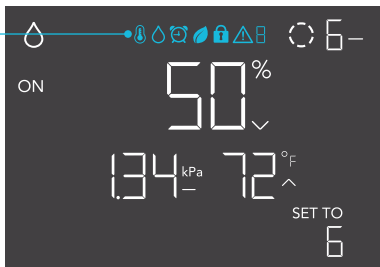

Screen shown: CLOUDFORGE T3



TIMER ALERT

Flashes when a countdown has completed in the TIMER or CYCLE Mode.



VPD ALERT

Flashes whenever the VPD Mode trigger activates your humidifier.



DISPLAY LOCK ALERT

Displays when you lock the screen. The icon will flash and beep if you attempt to adjust your humidifier while it is still locked.

OTHER SETTINGS

FACTORY RESET

Holding the mode, up, and down buttons together for 5 seconds will reset your humidifier and restore factory settings. This clears all user parameters in each mode and setting.

HOLD +   

CONTROLLER LOCK

Holding the setting button will lock the humidifier in your current mode. While your humidifier is locked, no parameters may be adjusted, nor will you be able to switch modes. Holding the setting button again will unlock the humidifier.

HOLD + 

HIDE SCREEN

Lock the humidifier so no settings can be adjusted. See above. Then press the setting button to turn the display off. Pressing it again will turn the display back on. Programs will still run in the background while the LCD screen is off.

PRESS + 

JUMP TO OFF MODE

Holding the mode button for 3 seconds while in any mode or setting will automatically jump to OFF Mode. This function is disabled if the humidifier is locked.

HOLD + 

OTHER SETTINGS

RESET TO OFF/DEFAULT

Holding the up and down buttons together for 2 seconds will reset the value of your current mode or setting to default. In AUTO and VPD Mode, pressing either the up or down button will return to its previous value.

HOLD +  

AUTO INCREASING OR DECREASING

Holding the up or down button will increase or decrease the user setting automatically until you release them.

HOLD +  

DISABLE BEEPING

Holding the mode and up buttons for 3 seconds will turn off beeping sounds. A single beep will indicate beeping sounds are disabled when using the onboard controller. Holding the mode and up buttons again will re-enable them.

HOLD +  

AC INFINITY PRODUCTS

Advance Grow Tents

The CLOUDLAB series is a line of grow tents designed to create ideal growing conditions and facilitate indoor plant cultivation year-round. Features 2000D thick oxford canvas lined with inner diamond-patterned mylar that maximizes grow light luminosity, and a reinforced frame with 150 lb. weight capacity. Includes a mounting plate to install your AC Infinity controller onto.

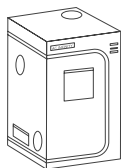

Thermo-Hygrometers

The CLOUDCOM series is a line of smart thermo-hygrometers designed to accurately detect and measure your space's temperature and relative humidity. Features a bright backlit screen and desktop, wall, or magnetic mounting options to place and display anywhere. Select models include a corded, Swiss-made sensor probe by Sensirion AG for spot detection.

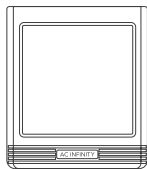

CONTROLLER 69 PRO

The CONTROLLER 69 PRO is the centerpiece of the UIS platform, able to connect with our smart devices including fans and LED grow lights to create the optimal growing environment. Connects with up to four devices to provide independent programming while capable of dynamically adjusting fan speed and brightness intensity levels in response to temperature, humidity, and VPD levels.



Discover the latest innovations in environmental controls at [acinfinity.com](https://www.acinfinity.com)

WARRANTY

This warranty program is our commitment to you, the product sold by AC Infinity will be free from defects in manufacturing for a period of two years from the date of purchase. If a product is found to have a defect in material or workmanship, we will take the appropriate actions defined in this warranty to resolve any issues.

The warranty program applies to any order, purchase, receipt, or use of any products sold by AC Infinity or our authorized dealerships. The program covers products that have become defective, malfunctioned, or expressively if the product becomes unusable. The warranty program goes into effect on the date of purchase. The program will expire two years from the date of purchase. If your product becomes defective during that period, AC Infinity will replace your product with a new one or issue you a full refund.

The warranty program does not cover abuse or misuse. This includes physical damage, submersion of the product in water, incorrect Installation such as wrong voltage input, and misuse for any reason other than intended purposes. AC Infinity is not responsible for consequential loss or incidental damages of any nature caused by the product. We will not warrant damage from normal wear such as scratches and dings.

Contact our dealers department at dealers@acinfinity.com or (626) 838-4656 for more information about our dealers and distributors program. Contact our customer service department at support@acinfinity.com or 626-923-6399 for product and warranty assistance. Our business hours are Monday through Friday, 9:00 am to 5:00 pm PST.



If you have any issues with this product, contact us and we'll happily resolve your problem or issue a full refund!

COPYRIGHT © 2023 AC INFINITY INC. ALL RIGHTS RESERVED

No part of the materials including graphics or logos available in this booklet may be copied, photocopied, reproduced, translated or reduced to any electronic medium or machine readable form, in whole or in part, without specific permission from AC Infinity Inc.

www.acinfinity.com