

Dishwasher

User manual

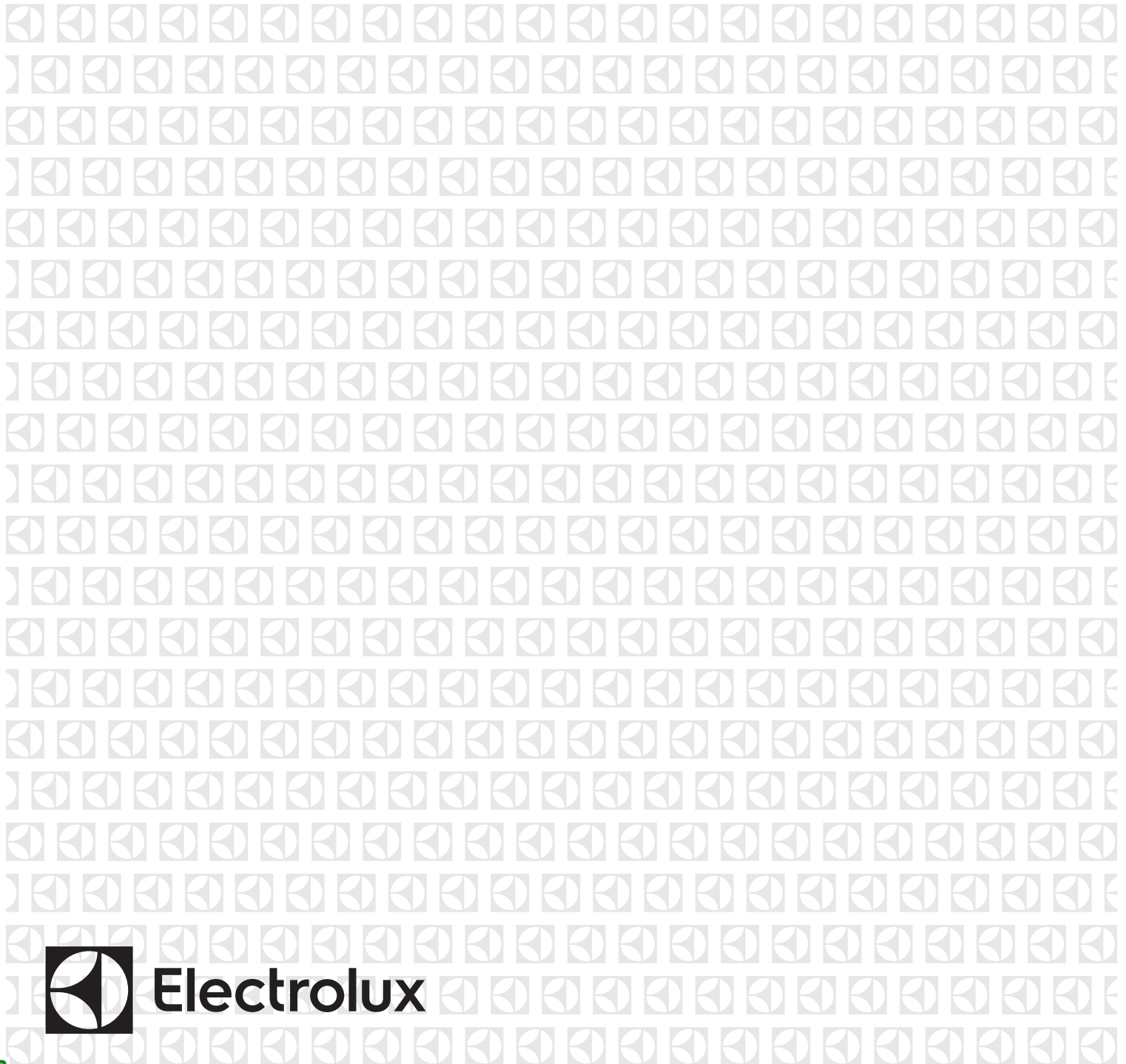

CONGRATULATIONS

Thank you for purchasing an Electrolux dishwasher. You've chosen a product that brings with it decades of professional experience and innovation. Ingenious and stylish, it has been designed with you in mind. So whenever you use it, you can be safe in the knowledge that you'll get great results every time.

Welcome to Electrolux.

REGISTERING YOUR APPLIANCE

Please visit our website www.electrolux.com.au/register to quickly and easily register your product.

BEFORE USING YOUR APPLIANCE

Check for any damage or marks. If you find the appliance damaged or marked you must report it within 7 days to claim for damages under the manufacturers warranty.

Before you use the appliance, we recommend that you read through the whole user manual which provides the description of the product and its functions. It is important that the product is installed correctly and that you read the safety instructions carefully to avoid misuse and hazards.

For future reference, please store this booklet in a safe place.

This appliance complies with the requirements of Australian Standard AS/NZS 60335.2.5.

CONDITIONS OF USE

This appliance is intended to be used in household and similar applications such as:

- Staff kitchen areas in shops, offices and other working environments
- Farm houses
- By clients in hotels, motels and other residential type environments
- Bed and breakfast type environments.

BEFORE YOU CALL

Please ensure you read the instruction manual fully before you call for service, or a full service fee could be applicable. Record model and serial number here:

Model number: _____

Serial number: _____

PNC number: _____

CONTENTS

Safety information	3
Product description	5
Getting familiar with your machine	6
Programs	7
Options	9
Before first use	10
Daily use.....	11
Settings	12
Hints and tips	17
Loading your dishwasher.....	19
Care and cleaning.....	21
Consumption values	22
Power half load consumption values.....	23
Troubleshooting	24
Technical specifications	27
Installation	28
Warranty.....	31

IMPORTANT INFORMATION THAT MAY IMPACT YOUR MANUFACTURER'S WARRANTY

Adherence to the directions for use in this manual is extremely important for health and safety. Failure to strictly adhere to the requirements in this manual may result in personal injury, property damage and affect your ability to make a claim under the Electrolux manufacturer's warranty provided with your product. Products must be used, installed and operated in accordance with this manual. You may not be able to claim on the Electrolux manufacturer's warranty in the event that your product fault is due to failure to adhere this manual.

SAFETY INFORMATION

SYMBOLS



WARNING!

This symbol indicates information concerning your personal safety.



CAUTION!

This symbol indicates information on how to avoid damaging the appliance.



IMPORTANT!

This symbol indicates tips and information about use of the appliance.



ENVIRONMENT!

This symbol indicates tips and information about economical and ecological use of the appliance.

Before the installation and use of the appliance, carefully read the supplied instructions. The manufacturer is not responsible for any injuries or damages that are the result of incorrect installation or usage. Always keep the instructions in a safe and accessible location for future reference.

Children and vulnerable people safety

- This appliance can be used by children aged from 8 years and above and persons with reduced physical, sensory or mental capabilities or lack of experience and knowledge if they have been given supervision or instruction concerning the use of the appliance in a safe way and understand the hazards involved.
- Do not let children play with the appliance.
- Keep detergents away from children.
- Keep children and pets away from the appliance when the door is open.
- Children shall not carry out cleaning and user maintenance of the appliance without supervision.

General Safety

- Do not change the specification of the appliance.
- The operating water pressure (minimum and maximum) must be between 0.03MPa (0.3bar - 1 MPa (10bar)
- Obey the maximum number of 15 place settings.
- If the supply cord is damaged, it must be replaced by the manufacturer, its Authorised Service Centre or similarly qualified persons in order to avoid a hazard.
- Put cutlery in the cutlery basket with the sharp ends pointing down or put them in the cutlery drawer in horizontal position with the sharp edge down.
- Do not leave the appliance with the open door unattended to avoid stepping accidentally onto it.

- Some dishwasher detergents are strongly alkaline. They can be extremely dangerous if swallowed. Avoid contact with the skin and eyes and keep children away from the dishwasher when the door is open.
- Before any maintenance operation, deactivate the appliance and disconnect the mains plug from the socket.
- Do not use high pressure water sprays and/or steam to clean the appliance.
- If the appliance has ventilation openings in the base, they must not be covered e.g. by carpet.
- The appliance is to be connected to the water mains using the new supplied hose-sets. Old hose-sets must not be used.

Safety instructions

Installation

- Remove the packaging.
- Do not install or use a damaged appliance.
- Do not install or use the appliance where the temperature is less than 0°C.
- Follow installation instructions supplied with appliance.
- Make sure that the appliance is installed below and adjacent to safe structures.

Electrical connection



WARNING!

Risk of fire and electrical shock

- The appliance must be earthed.
- Make sure the parameters on the rating plate are compatible with the electrical ratings of the main power supply.
- Always use a correctly installed shock proof socket.
- Do not use multi-plug adapters and extension cables.
- Make sure not to cause damage to the mains plug and the mains cable. Should the mains cable need to be replaced, this must be carried out by our Authorised Service Centre.
- Connect the mains cable to the mains socket only at the end of the installation. Make sure that there is access to the mains plug after installation.
- Do not pull the mains cable to disconnect the appliance. Always pull the mains plug.

Water connection

- Do not cause damage to the water hoses.
- Before connection to new pipes, pipes not used for a long time, where repair work has been carried out or new devices fitted (water meters etc.), let the water flow until it is clean and clear.

SAFETY INFORMATION

Use

- Do not sit or stand on the open door.
- Dishwasher detergents are dangerous. Follow the safety instructions on the detergent packaging.
- Do not drink and play with the water in the appliance
- Do not remove the dishes from the appliance until the program is complete. Some detergent may remain on the dishes.
- The appliance can release hot steam if you open the door while a program operates.
- Do not put flammable products or items that are wet with flammable products in, near or on the appliance.



Disposal



WARNING!

- Risk of injury or suffocation
- Disconnect the appliance from the mains power supply.
- Cut off the mains cable and discard it.
- Remove the door catch to prevent children and pets to get closed in the appliance.

Environmental concerns

- Recycle the materials with the symbol . Put the packaging in applicable containers to recycle it. Help protect the environment and human health and to recycle waste of electrical and electronic appliances. Do not dispose appliances marked with the symbol  with the household waste. Return the product to your local recycling facility or contact your municipal office
- Ensure that there are no visible water leaks during and after the first use of the appliance.
- If the water inlet hose is damaged immediately close the water tap and disconnect the mains plug from the mains socket. Contact the Authorised Service Centre to replace the water inlet hose.

PRODUCT DESCRIPTION

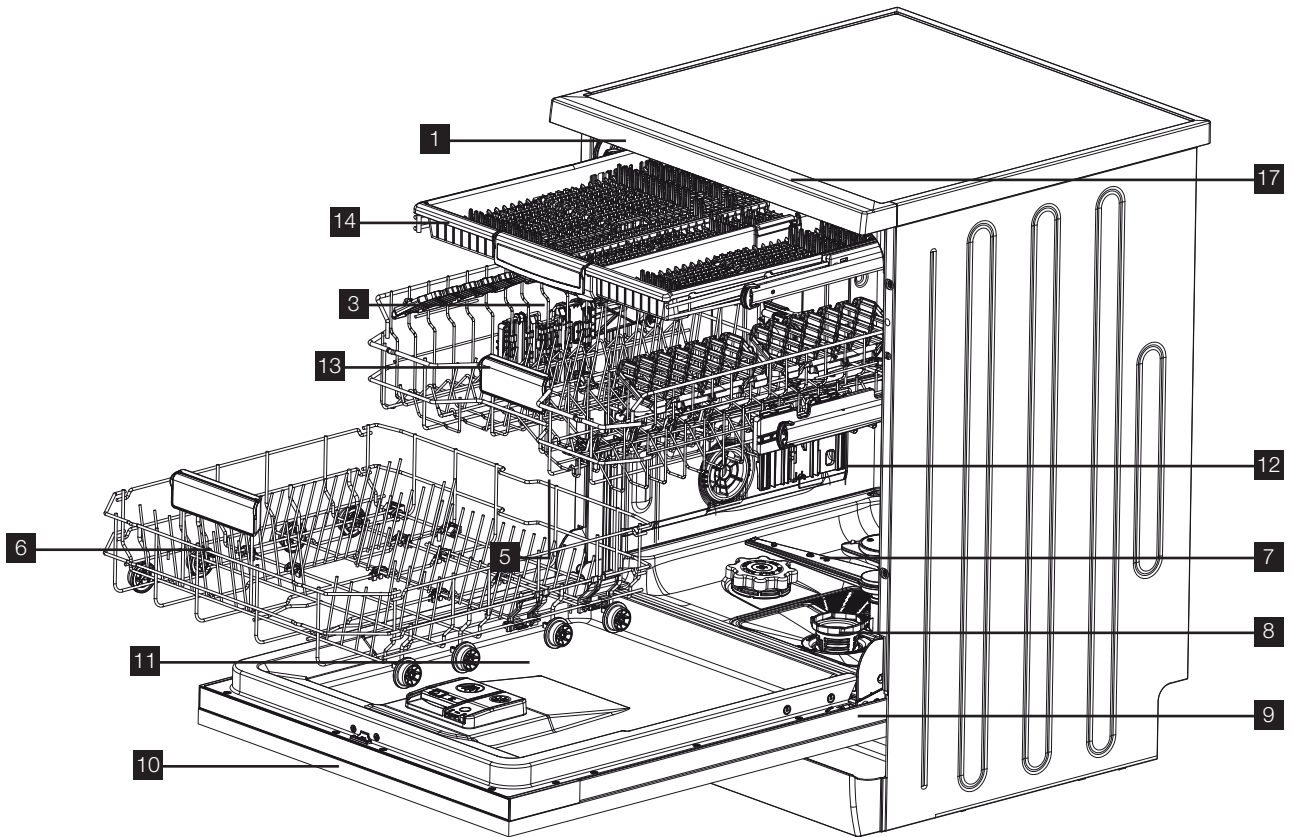

- 1 Worktop
- 2 Glass stem grip on cup racks
- 3 Upper basket with cup racks
- 4 Upper basket direct wash system
- 5 Upper spray arm
- 6 Lower basket with folding supports
- 7 Lower spray arm triple wash system
- 8 Filters
- 9 Rating plate
- 10 Control panel
- 11 Detergent and rinse-aid dispenser
- 12 Upper basket height adjusting mechanism
- 13 Basket handle
- 14 Cutlery tray
- 15 Ceiling spray
- 16 Turbo drying unit
- 17 Auto door opening
- 18 Light

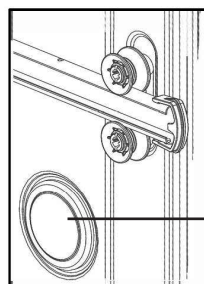
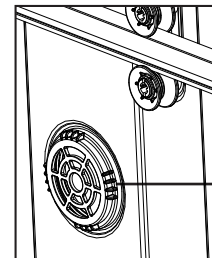
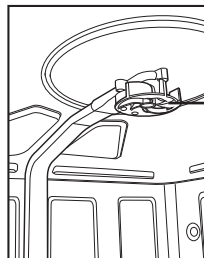
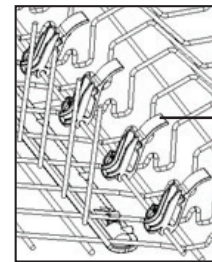
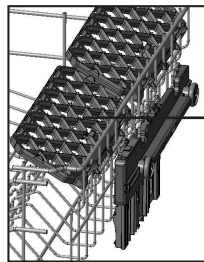

GETTING FAMILIAR WITH YOUR MACHINE

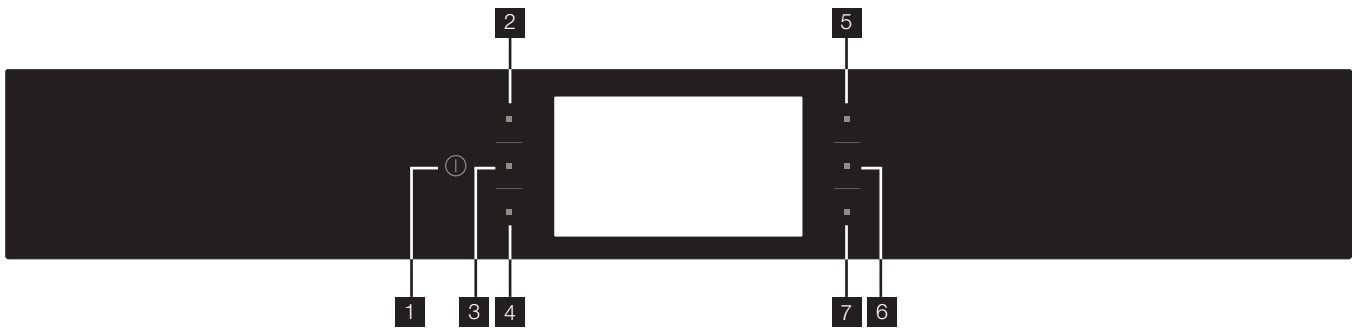

Program Selection and Operating the Machine



1. On/Off Button

The machine will be energised when the On/Off button is pressed and held until the screen is turned on. The machine will be switched off when you press and hold the On/Off button again until the display turns black.



2. Program Button

Allows you to select the appropriate program.



3. Option Button

Allows you to use the functions in the additional functions menu. Also acts as the 'back' button when the settings are being changed.



4. Time Delay Button

Allows you to delay the starting time of the selected program for a period between 30 minutes to 24 hours. You can see the delay time on the Remaining Time/Delay Time indicator. "TIME DELAY ACTIVE!"



5. Settings Button

You can navigate the settings menu by pressing the settings button before starting the Program.



6. Favourite Button

It allows you to enter the "Favourite" menu that includes 5 favourite Programs you have previously saved. Also is forward button when the settings are being changed.



7. Start/Pause Button

When you press the Start/Pause button, the Program you have selected will start and the washing bar will be shown on the display. You can track the time remaining until the end of the washing on the display. If you press this button during an active program, the program will pause and the remaining time will stop. The program will resume when you press this button again.

PROGRAMS

Program	Degree of soil type of load	Program phases	Options	Detergent Amount	
Prewash	-	Cold rinse	Delay start, Power Half load, Child lock	-	
Jet Wash 14'	Low soil levels, fresh light soil, coffee, milk, tea	Main wash 35°C Hot rinse	Delay start, Power Half load, Child lock, Energy Save	25	Powder, Gel
Quick 30'	Low soil levels, fresh light contamination, coffee, tea, milk, cold meat, vegetables	Main wash 40°C Cold rinse Hot rinse	Delay start, Power Half load, Child lock, Extra drying, Energy Save	15	Powder, Gel
Eco	Normal soil levels, old soups, sauces, pastries, egg, rice, potato and oven foods, fried foods	Cold rinse Main wash 50°C Warm rinse Hot rinse	Delay start, Power half load, tablet, child lock, extra fast, extra hygiene, extra drying, extra silent, Energy save	40	Powder, Tablet, Capsule
FlexiWash 60°C	For both delicate glassware and heavily soiled crockery at the same time	40°C wash, 65°C Lukewarm rinse, Hot rinse, Dry	Delay start, Power half load, tablet, child lock, extra fast, extra hygiene, extra drying, extra silent, Energy save	30	Powder, Tablet, Capsule
Super 50'	Medium soil levels, old soups, sauces, pastries, egg, rice, potato and oven foods, fried foods	Main wash 65°C Warm rinse Hot rinse	Delay start, Power half load, tablet, child lock, extra hygiene, extra drying, Energy save	40	Powder, Gel
AutoFlex 30°C - 50°C	Automatically adjusts the washing time, temperature and amount of water by determining the level of soil	Washing steps are determined automatically according to the level of soil	Delay start, Power Half load, Tablet, Child lock, Extra hygiene, Extra drying, Energy save	25	Powder, Gel
AutoFlex 50°C - 60°C			Delay start, Power Half load, Tablet, Child lock, Extra hygiene, Extra drying, Energy save	30	Powder, Tablet
AutoFlex 60°C - 70°C			Delay start, Power Half load, Tablet, Child lock, Extra hygiene, Extra drying, Energy save	30	Powder, Tablet
Steam Wash	Heavy soil levels, old soups, sauces, pastries, egg, rice, potato and oven foods, fried foods		Delay start, Power Half load, Tablet, Child lock, Extra hygiene, Extra drying	30	Powder, Tablet, Capsule

Warning: In Jetwash 14 min, Quick 30 min and Super 50 min programs, there is no drying phase.

FlexiWash

This program is to wash both delicate/less soiled dishes and heavily soiled dishes at the same time. The delicate dishes on the upper basket are washed at a lower pressure and the heavily soiled dishes on the lower basket are washed at a higher pressure.

PROGRAMS (CONTINUED)

Additional Options



Extra Fast Option

Increases the water pressure of the selected Program, thus shortens its duration and reduces the amount of water.



Extra Silent Option

Allows for a sensitive and silent washing cycle by making the Program wash the dishes with lower pressure.



Extra Drying Option

Using the extra drying option, you can have drier dishes by adding extra drying steps to the Program you have selected.



Energy Save Option – Auto Door

Thanks to the energy save option, the automatic door opening mechanism will be activated when the Program is complete. Door will open for 10cm when drying and rinsing is complete and the steam in the machine will be released for better drying performance.

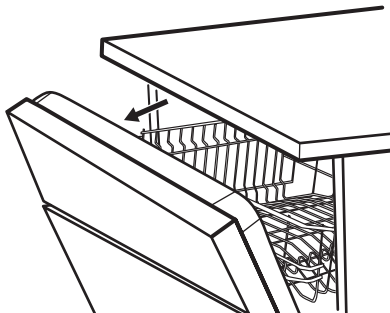

Extra Hygiene Option

You can select the hygiene option for dishes requiring extra hygiene and achieve a more hygienic wash by changing the washing temperature and duration of the current Program.



Tablet Detergent Option

Please use the Tablet Detergent option when using combined detergents containing salt, rinse aid and extra features.



Power Half Load Option

With the half load option, three different washes can be performed, namely in the upper basket, lower basket and both baskets. If you have a small amount of dishes you need to wash in the machine, you can activate the half load option as an addition to some programs. If you have dishes in both baskets, select the icon that lights both figures by selecting the half load option.

If you have dishes in the upper basket only, select the icon where the figure above is lit. Therefore, only the upper basket of your machine will perform washing. For this reason, make sure you do not have dishes in the lower basket. If you have dishes in the lower basket only, select the icon where the figure below is lit. Therefore, only the lower basket of your machine will perform washing. Make sure that there are no dishes in the upper basket while using this feature.



Power Half Load upper basket – DIRECT WASH

For a partial load where there are difficult to remove food soils the dishware can be located over the direct wash jets in the upper baskets. These additional jets will provide a direct spray to the interior of the dishware.



Power Half Load lower basket – TRIPLE WASH







For a partial load where there are difficult to remove food soils. Large soiled items should be placed over the triple wash sprays at the back of the lower basket.

You may change the program according to your preferences by selecting additional options to the washing program. The washing programs have been designed so as to obtain the best cleaning considering the type and amount of food soil properties of the washing materials. The additional functions were developed in order to save time, water and electricity and thus allow you to wash your dishes more conveniently. For example, if you think your dishes are slightly dirty, you may select the Fast function  and make your washing process more economical in terms of time and water.

If you are going to use a multipurpose detergent, you obtain better performance by selecting Tablet detergent  function.

If you live in a place where electricity is cheaper to use at night, you might select the silent function  and wash your dishes more economically and silently; this function was developed also for a more sensitive washing process.

Additional options are not suitable for every program; you might find below the functions suitable for the programs. For the programs not suitable for functions, you will see that the function indicator is not illuminated.

Programs	 Time Delay	 Power Half Load	 Tablet	 Child Lock	 Extra Fast	 Extra Hygiene	 Extra Silent	 Extra Drying	 *Energy Save
Prewash	✓	✓	×	✓	×	×	×	×	×
Jet Wash 14'	✓	✓	×	✓	×	×	×	×	✓
Quick 30'	✓	✓	×	✓	×	×	×	✓	✓
Eco	✓	✓	✓	✓	✓	✓	✓	✓	✓
FlexiWash 60°C	✓	✓	✓	✓	✓	✓	✓	✓	✓
Super 50'	✓	✓	✓	✓	×	✓	×	✓	✓
AutoFlex 30°C - 50°C	✓	✓	✓	✓	×	✓	×	✓	✓
AutoFlex 50-60°C	✓	✓	✓	✓	×	✓	×	✓	✓
AutoFlex 60°/70°C	✓	✓	✓	✓	×	✓	×	✓	✓
Steam Wash	✓	✓	✓	✓	×	✓	×	✓	×

“×” Function cannot be selected “✓” function can be selected.

*Note: Energy Save will add extra time to the program cycle.

OPTIONS

Options	Delay Start	Power Half Load	Tablet	Child Lock	Extra Fast	Extra Hygiene	Extra Silent	Extra Drying	Energy Save
Delay Start		✓	✓	✓	✓	✓	✓	✓	✓
Power Half Load (3 modes)	✓		✓	✓	✓	✓	✓	✓	✓
Tablet	✓	✓		✓	✓	✓	✓	✓	✓
Child Lock	✓	✓	✓		✓	✓	✓	✓	✓
Extra Fast	✓	✓	✓	✓		×	×	✓	✓
Extra Hygiene	✓	✓	✓	✓	×		×	×	✓
Extra Silent	✓	✓	✓	✓	×	×		✓	✓
Extra Drying	✓	✓	✓	✓	✓	×	✓		✓
Energy Save	✓	✓	✓	✓	✓	✓	✓	✓	

BEFORE FIRST USE

1. Fill the rinse aid dispenser.
2. Turn on the water tap.
3. Start a program ('Super 50' is recommended) to remove any processing residuals that can still be inside the appliance. Do not use detergent and do not load the baskets.

Filling the rinse-aid and setting

To fill the rinse aid compartment, open the rinse-aid compartment cap. Fill the compartment with rinse aid until MAX level and then close the cap. Be careful not to overfill the rinse aid compartment and wipe up any spills.

Rinse aid level is changed by using Rinse aid menu.

Be careful not to overfill the rinse aid compartment and wipe up any spills.

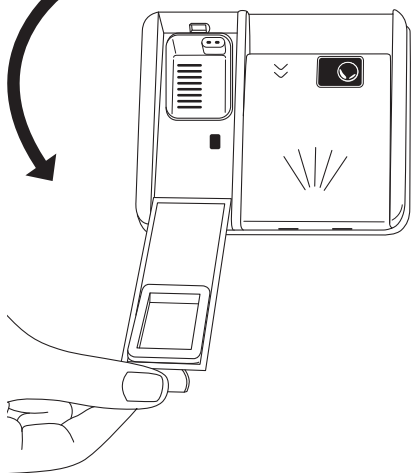
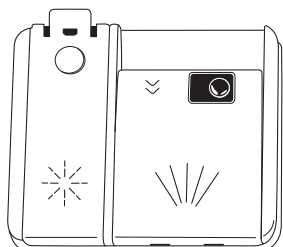
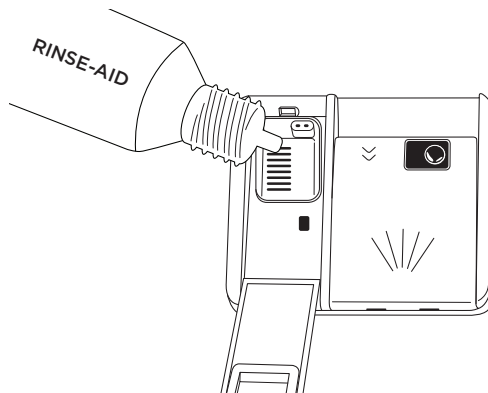



i IMPORTANT!

Fill the rinse aid dispenser when the indicator on the display illuminates.

If you use multi-tablets we recommend to always use rinse aid for better drying performance, also in combination with multi tablets containing rinsing agent.

DAILY USE

1. Turn on the water tap.
2. Press the on/off button  to activate the appliance. Make sure that the appliance is in program selection mode. If the rinse aid indicator * is on, fill the rinse aid dispenser.
3. Load the basket.
4. Add the detergent.
5. Set the start, the correct program  and options  for the type of load and the degree of soil. See Settings section for more detail.

Adding the detergent



CAUTION

Only use detergent specifically designed for dishwashers

Press the latch to open the detergent container as shown in the image.

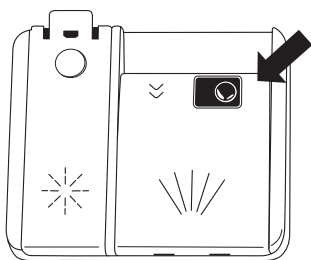

Detergent container has level lines inside. It is possible to measure the right detergent amount using these lines.

The detergent container can take a maximum of 40cm³ detergent.

Open the dishwasher detergent container and pour 25cm³ if your dishes are heavily soiled or 15cm³ if they are less soiled.

You may have to add more detergent into your machine, depending on the degree of soil and the water hardness in your area.

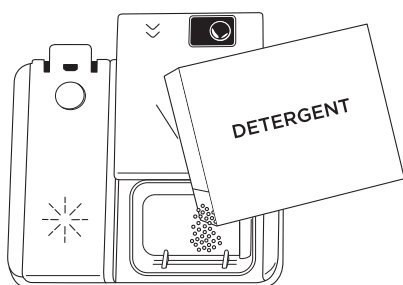

If your dishes are from the previous day and there is dried food waste on them, or if you have fully loaded the dishwasher, pour 5cm³ detergent onto the base of the door and start your machine.

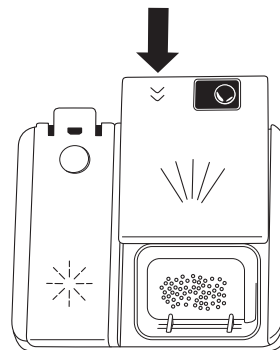

To close the detergent container, push the cover as shown until it locks.



CAUTION

Solubility of the tablet detergents produced by different companies can vary depending on the temperature and time. Therefore, it is not recommended to use tablet detergents in short programs. It is more suitable to use powder detergents for these programs.



IMPORTANT!

If your dishes have been dirty for a long period, if there is dried food waste on them and if you have fully loaded the dishwasher, pour 5cm³ detergent into the pre-wash compartment and start your machine.

You may have to add more detergent into your machine, depending on the degree of soil and on the water hardness level.

Opening the door while the appliance operates

If you open the door while a program is running, the appliance stops. It may affect the energy consumption and the program duration. When you close the door, the appliance continues from the point of interruption.



CAUTION!

Do not try to close the appliance door within 1 minute after Auto Door automatically opens it, as this may cause damage to the appliance.



CAUTION

When opening the door of the machine while a program is in progress, open the door slightly in order to avoid spillage of hot water with detergent, or excessive steam.



IMPORTANT!

Make sure that there is detergent in the detergent dispenser before you start a new program.

End of program.

When the program is completed, open the door and press the power button to turn off the appliance.

Turn off the water tap.

SETTINGS

Turning on the machine

1. Press and hold the On/Off button until the screen is turned on.
2. Eco program will be selected the first time the appliance is turned on.

Note: When turned on after first use the program will default to the program last used, unless a favourite program ☆ has been set up. In that case it will default to favourite 1. Other favourite programs 2, 3, etc will follow if set up.

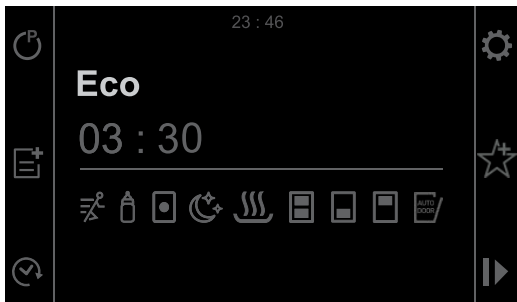

3. Select the desired Program by pressing the Program button Ⓢ successively.

Select the washing Program according to your dishes, using the Program listed on the previous page.

4. You can select options Ⓢ according to the options list on previous page.
5. You can start the Program by pressing the Start/Pause button ▶. "WASHING" will be shown on the display and the Program you have selected will start.



When the Program starts working, you can track the name of the Program on the display information line (1), the remaining time on the remaining time indicator (2), the progress of the Program on the progress bar (3), the options you have selected on the options indicator (4).

NOTE: Be careful not to open the door of the machine while it is running. If you need to open, pause the Program by pressing the Start/Pause button. "PROGRAM PAUSED!" warning will be shown on the display. You can open the door after you have seen this warning.

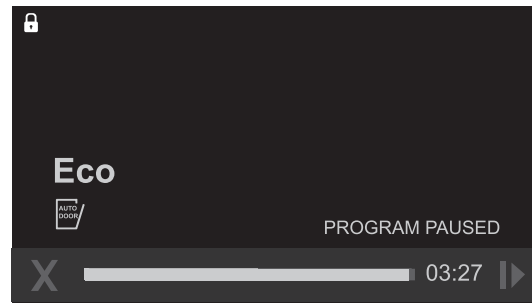

Steam may be released when you open the door of your machine. Be careful. Press the Start/Pause button again after closing the machine door. The Program will resume and the screen will display "WASHING".

Program Monitoring

You can track the progress of the Program using the progress bar. Remaining time and program places expressions (washing, program finished) will be shown on the display.

NOTE: If the door of the machine is opened or power gets disconnected during washing, the Program will resume when the door is closed or the power is supplied again.

NOTE: In order for the drying process to be performed more quickly, you may manually slightly open the machine door after a few minutes when the Program has ended and you have seen the "PROGRAM FINISHED".

Alternately activate the 'Auto Door' option and the door will open automatically at the end of the Program.

Cancelling the Program

1. Press the cancel button located on the left-hand side of the washing bar to cancel a program in progress.
2. The display will show "Program will be cancelled. Could you confirm please?" warning.

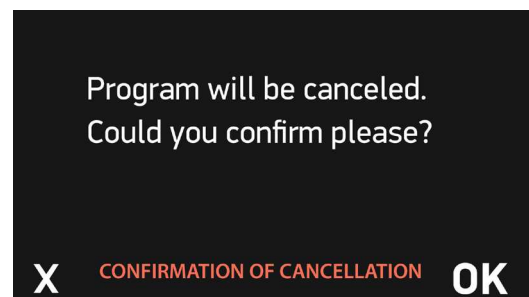

3. The Program will be cancelled when you press the confirm button on the bottom-right corner of the display and the display will show "CANCELLING".

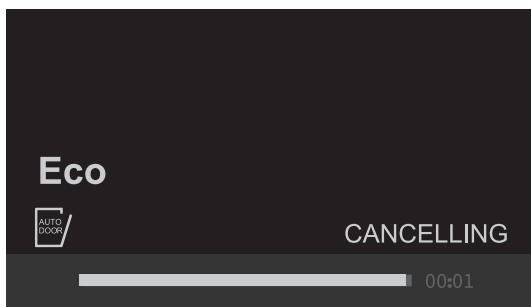

4. 1 minute after you cancel the program “PROGRAM FINISHED” warning will be displayed.

5. You can now select a new Program, additional options or time setting by pressing the back button.

NOTE: Detergent or rinse aid residues may be present in the machine or on the dishes being washed depending on the washing step of the Program you have cancelled.

Settings Menu

Press the settings button  to access the settings menu. Menu contents are as follows;

1. Time settings
2. Date settings
3. Volume settings
4. Rinse aid settings
5. Factory settings
6. Brightness
7. Language
8. Eco mode

Press back to exit the menu.

NOTE: You can access the short details of the related menu by pressing the info button on the top right corner of the screen.

1. Time settings

Switch to “TIME SETTINGS” menu using the Forward/backward buttons. When you enter the “TIME SETTINGS” by pressing confirm, hour section is selected. New hour can be set when you press confirm. You can select the desired hour by pressing Forward/Backward. The new hour is set by pressing confirm. The hour set will not be saved if you press back instead of confirm. Switch to the minute setting section by pressing forward. New minute can be set when you press confirm. You can select the desired minute by pressing Forward/Backward. The new minute is set by pressing confirm and the new hour setting will be saved. The minute set will not be saved if you press back instead of confirm.

2. Date settings

Switch to the “DATE SETTINGS” menu using the Forward/backward buttons. When you enter “DATE SETTINGS” by pressing confirm, “DAY” section will be shown at first. Press confirm to change the day on the display. Change the selection using the “Forward/Backward” buttons and press confirm to save.

Secondly, “MONTH” section will be shown when you press forward. Follow the steps you followed for the day setting to change the selection.

Finally, move to the “YEAR” section. Follow the steps you followed for day and month settings to change the selected year.

3. Volume settings

You can set the level of the audio warnings that your machine emits. Default volume level is “2”, shown in blue when you first start your machine. 0 is the silent level and 5 is the highest volume level. Select the desired volume level using forward/backward buttons after entering the menu. Press confirm once the required volume setting is chosen.

4. Rinse aid settings

Switch to “RINSE AID” menu using the Forward/backward buttons and press confirm to enter the menu.

The level selected in blue shows the last selected rinse aid level. Select the new level using forward/backward buttons. The newly selected level will be saved by pressing confirm and will turn to blue.

6. Brightness

You can adjust the display brightness of your machine here. Brightness level is “5”, shown in blue when you first start your machine. 0 is the lowest brightness level and 5 is the highest. Select the desired brightness level using forward/backward buttons after entering the menu, and the newly selected level will be saved by pressing confirm.

7. Language

Switch to the “LANGUAGE” menu using Forward/backward buttons. Press confirm to enter the Language menu. Language selected in blue shows the selected language. Select the new language using forward/backward buttons, and the newly selected language will be saved by pressing confirm.

SETTINGS (CONTINUED)

8. Eco mode

The internal light lights up when you open the door of the machine. Select “Yes” with the forward/backward buttons < > to activate the Eco mode and press OK.

The following describes how Eco mode affects functionality during various stages of dishwashing:

The program selection screen:

- If there is no user interference to the machine during 15 minutes, the machine turns off.
- If there is no user interference to the machine during 2 minutes the backlight turns off.
- When the door is opened, the inner light turns ON and after 2 minutes it turns OFF.

When a program is operating:

- The backlight is always ON.
- When the door is opened, the inner light turns ON and after 2 minutes it turns OFF.

To deactivate Eco mode, select “No” with the forward/backward button < > and press OK. In this case, internal illumination will be lit as long as the door is open.

5. Factory settings

When you enter the menu, “Yes” will be selected and “All settings will be reset. Could you confirm please?” expression will be displayed when you confirm with the confirm button. Press cancel if you do not confirm. Press confirm to return your machine to the Factory settings. Factory settings menu will appear again. Your machine’s factory settings are as follows;



- Favourite Programs are deleted
- Eco-mode is active
- Volume level is 2
- Display brightness level is 5
- Economical time interval is between 22:00-06:00
- Hour is 00:00

- Date is 01.01.2016

Your settings will not be changed if you select “No” and press confirm.

Favourite Program Setting

You can add the programs and options that you consider are best for your dishes and you frequently use to the Programs list in the favourites menu. To set your favourite Program;

1. Select the Program that you want to select using the Program button .
2. Add the suitable options for the wash using the options button  if you want to add additional options to this Program.
3. When you press the favourites button  after completing your Program and option selection, the screen below will be displayed.

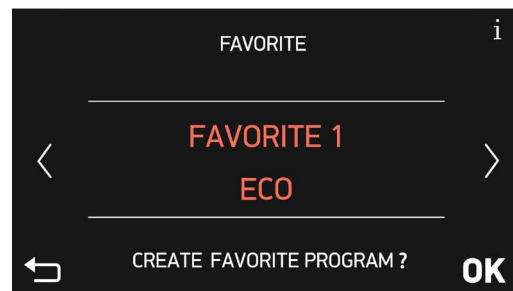

4. Use forward/backward buttons < > to save the selection in any of the selections (Favourite1, Favourite2, Favourite3, Favourite4 and Favourite5).
5. Move Favourite1 to the center of the screen using forward/backward buttons < > if you are going to save the selection to Favourite1.
6. The prompt ‘Create favourite program?’ will appear. Press OK to confirm and save.

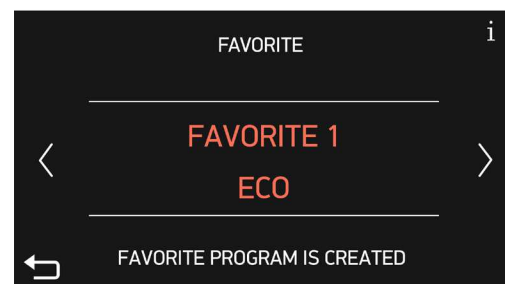

7. Press the back button  if you do not want to save.

8. You will be redirected to the favourite Program selection menu when you press OK again.

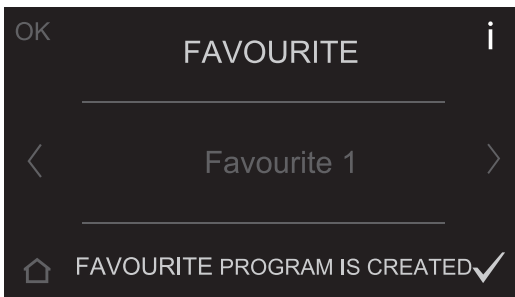

After you press “OK”, your favourite Program and options you have added will be saved to the Favourite you have selected.

Child Lock

You can prevent others from changing your settings while your machine is operating. Press and hold the child lock button  on the top left corner of the screen for 3 sec.

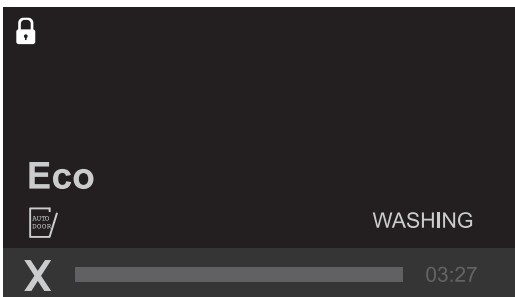

“Child lock on” warning will be displayed and a warning tone will be heard when the child lock is active.

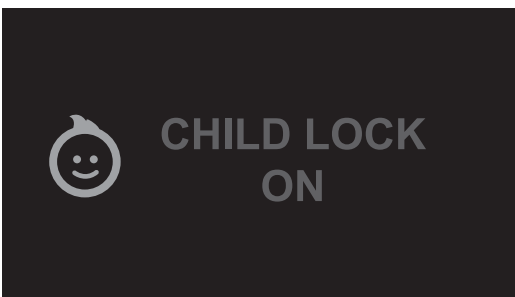



Child lock indicator on the top left corner of the screen will turn to the locked position. All buttons are non-functional when the child lock is active.

Press and hold the child lock button  for 3 seconds to cancel the child lock. “Child lock off” warning will be displayed on the screen and a warning tone will be heard. Child lock indicator will turn to unlocked position.







Time Delay for Wash Program (Delay):

You can delay the starting time of the selected Program up to 24 hours. Delay setting cannot be made after the Program has started. The selected Program should not be started for you to set the delay time.

1. Press the delay button  and increase delay for the time required for the delay.
2. Set the delay time to the desired time using forward/backward buttons  . Delay time is increased for 30 minutes with the forward button and decreased for 30 minutes with the backward button. Select the delay time by pressing the confirm button. You can start the delay time countdown by pressing the start/pause button. The display will show “TIME DELAY ACTIVE”, and the delay time and the Program time will be alternately shown on the display until the end of this time. The selected Program will start when countdown ends. The time required for the started Program to end will be shown on the indicator display. All buttons except for On/Off and Delay buttons will be disabled when delay is active.

If you want to cancel or set a new time when the machine is in delay

Press the delay button  to cancel the delay and press confirm by selecting “00:00” as the delay time. The display will show the latest selected Program and options. Delay time will not be shown.

Press the delay button  again to set a new delay time. Select the new time using forward/backward   buttons and press the start/pause button  to start the delay time.

Rinse Aid

The rinse aid helps to dry the dishes without streaks and stains. The rinse aid is automatically released during the hot rinse phase. When rinse aid chamber is empty, “LOW RINSE-AID” warning  is shown on the display notifying to refill rinse aid.

When you stop using combined detergents

- Fill the rinse aid compartment
- Set the suitable rinse aid setting

SETTINGS (CONTINUED)

Auto Door



Do not try to close the appliance door within 1 minute after automatic open. This can cause damage to the appliance.

In case of presence of children, if you want to keep the door closed in the end of the cycle, do not activate the Auto Door. Auto Door is not automatically activated with all programs and must be selected.

To improve the drying performance refer to the Programs charts to select a program with hotter temperatures.

If the machine door is opened during washing or the power is cut off, the machine will continue the program when the door is shut or the power is back.

HINTS AND TIPS

General

The following hints will ensure optimal cleaning and drying results in daily use and also help to protect the environment.

Before loading dishes

- Remove larger residues and food scraps from the dishes into the waste bin.
- When needed, use the prewash program (if available) or select a program with a prewash phase.
- For best results distribute the plates, cups and cutlery evenly in the baskets.
- When loading the appliance, make sure that the dishes can be completely reached and washed by the water released from the spray arm nozzles. Make sure that items do not touch or cover each other.
- You can use dishwasher detergent and rinse aid or you can use the multi-tablets (e.g. "3-in-1", "4-in-1", "All-in-1"). Follow the instructions written on the packaging.
- Select the program according to the type of load and degree of soil.

NOTE: With the Eco (Economic 50°C) program you have the most efficient use of water and energy consumption for crockery and cutlery with normal soil.



ENVIRONMENT!

Operate the machine after it is completely full.

Use pre-washing program only when necessary.

If the appliance is in a location where the risk of freezing exists, you must completely drain the water that has remained in the machine. Turn off the tap and drain the water from the inlet hose.

Using rinse aid and detergent

- Only use rinse aid and detergent for dishwashers. Other products can cause damage to the appliance.
- At least once a month run the appliance with the use of appliance cleaner which is particularly suitable for this purpose.
- Detergent tablets do not fully dissolve with short programs. To prevent detergent residue on the tableware, we recommend that you use the tablets with long programs.
- Do not use more than the correct quantity of detergent. Refer to the instructions on the detergent packaging.

Before starting a program

Make sure that:

- The filters are clean and correctly installed.
- The spray arms are not clogged.
- There is dishwasher rinse aid (unless you use multi-tablets).
- The position of the items in the baskets is correct.
- The program is applicable for the type of load and for the degree of soil.
- The correct quantity of detergent is used.



CAUTION!

Ensure that the dishes loaded in the baskets will not block the upper and lower spray arms and prevent them from spinning.

Loading the baskets

- Only use the appliance to wash items that are dishwasher-safe.
- Do not put in the appliance items made of wood, horn, aluminium, pewter and copper.
- Do not put in the appliance items that can absorb water (sponges, household cloths).
- Put hollow items (cups, glasses and pans) with the opening down.
- Soak (soften) and remove any burnt food from your crockery before placing in the dishwasher.
- Put cutlery and small items in the cutlery drawer.
- Put light items in the upper basket. Make sure that the items do not move.
- Make sure that the spray arms can move freely before you start a program.

HINTS AND TIPS (CONTINUED)

Height adjustable cup rack

These racks are designed to increase the capacity of the top basket. You can place your glasses and cups on the racks. You can adjust the height of these racks. Thanks to this feature, you can place different sizes of glasses under these racks.

If you have delicate stemmed glasses, the soft supports will support and protect the glasses.

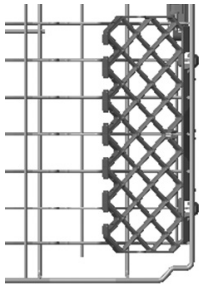

Upper basket

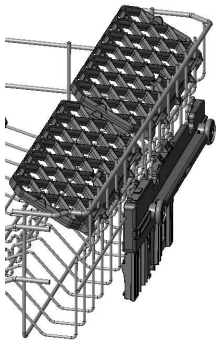

Due to the height adjustment mechanism mounted on the basket, you can use your cup racks at two different heights.

In addition, you can place long forks, knives and spoons on these racks horizontally, so that they do not block the rotation of the spray arm.

Upper basket folding racks

Folding tines (prongs) on the upper basket are designed to allow you to place larger items such as pots, pans, etc, easily. Each rack can be folded separately or together, depending on the space required.

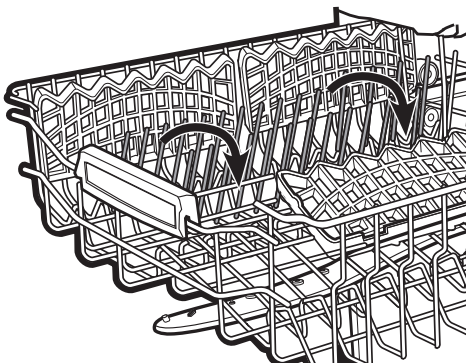

Upper basket height adjustment while it is full

Basket height adjustment mechanism on the upper basket of your machine is designed to let you adjust the height of your upper basket (refer to diagram 1) upwards or (refer to diagram 2) downwards, without removing it from your machine when it is full, to create large spaces at the upper or bottom area of your machine as needed.

The basket of your machine is set to the upper position from the factory.

In order to raise your basket, hold it from both sides and pull it upwards. In order to lower it, hold it from both sides again, pull upwards and then lower carefully.

Make sure that both sides are in the same position (up or down).

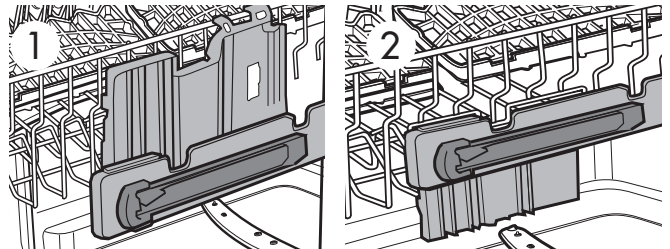
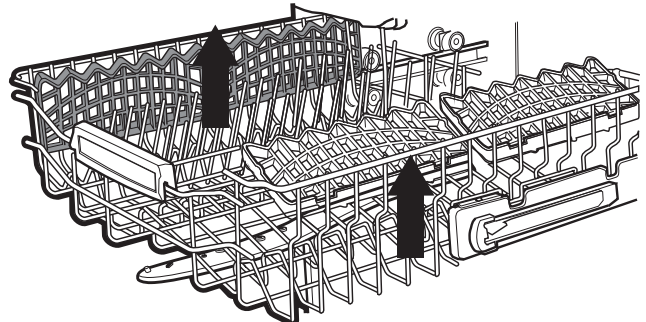

LOADING YOUR DISHWASHER

Upper Cutlery Tray

The upper cutlery tray is designed for you to place forks, spoons and knives, long and small items.



If desired, when the program has completed, the tray can be taken out with your cutlery.

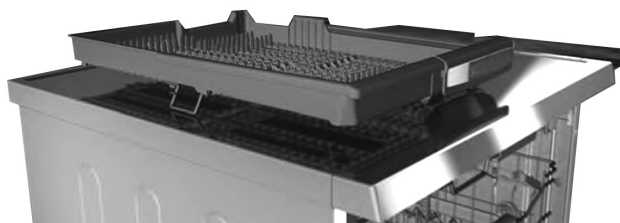

The upper cutlery basket is composed of two pieces; if you need to make space for the dishes in the upper basket, you can take out the left or right part of the upper cutlery basket in order to create more space.



Alternate cutlery basket (Accessory)

An alternate cutlery basket is available as an accessory if needed. This can be located in the lower basket.

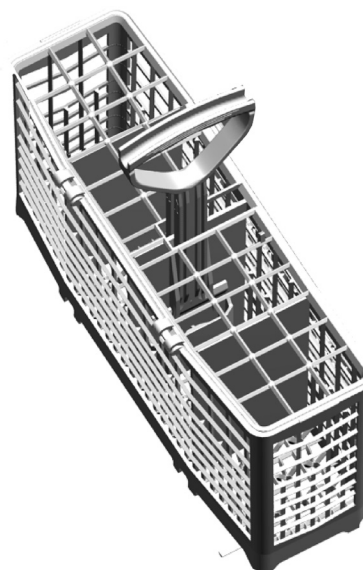

Wine glass holder (Accessory)

The sides of the wine glass holder fold up to allow for compact size when storing.

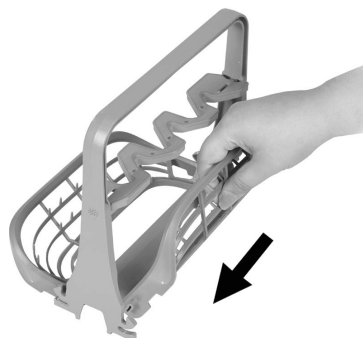

When the sides are fully expanded, wine glasses can be placed in the holder using the secure and space efficient formation below.



LOADING YOUR DISHWASHER (CONTINUED)

Lower Basket Folding Racks

Folding tines (prongs) consisting of four parts that are located on the lower basket of your machine are designed in order to let you place big items easier such as pots, pans, etc. If required, each rack can be folded separately, or all of them can be folded and larger spaces created. You can use folding tines (prongs) in the upright position, or by folding.

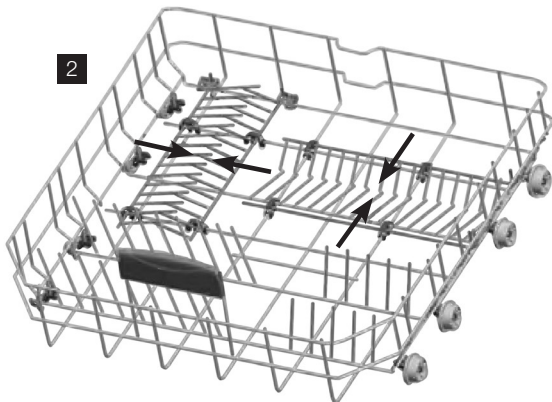
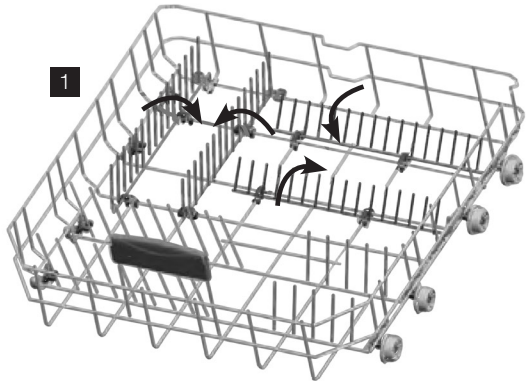

Alternative basket loads

Lower Basket

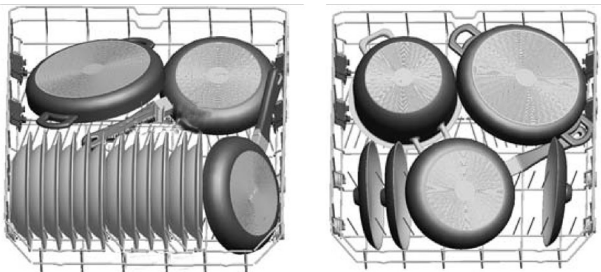

Upper Basket

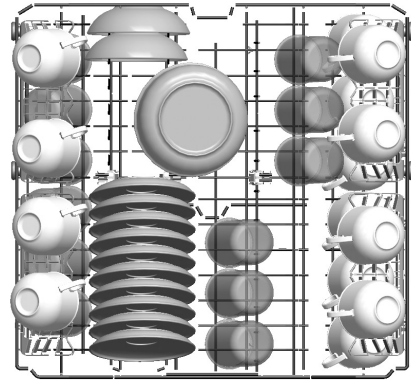

! WARNING!

Examples of incorrect loading

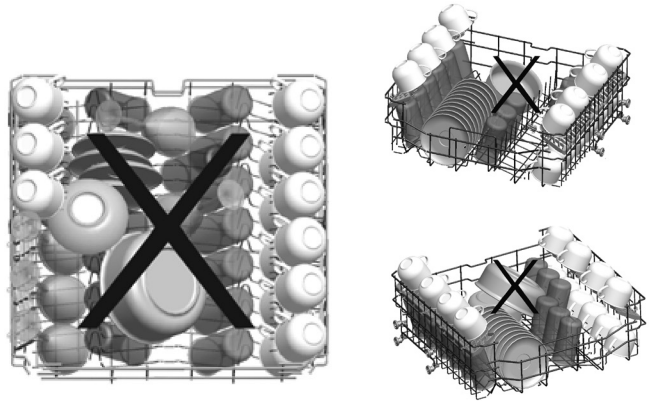

* Illustration only

Upper Cutlery Tray

The upper cutlery tray is designed for you to place forks, spoons and knives, long and small items.

1. Let the tableware cool down before you remove it from the appliance. Hot items can be easily damaged.
2. First remove items from the lower basket, then from the upper basket.

i IMPORTANT!

At the end of the program, water can still remain on the sides and on the door of the appliance.

For better drying results, set the auto door function, or open the door 5-10cm and allow tableware to cool down for 30-40 minutes.

Whenever you are away on holiday for an extended period:

- Unplug the machine and then turn the water off.
- Leave the door slightly ajar in order to prevent the formation of unpleasant smells.
- Keep the machine interior clean.

CARE AND CLEANING

Switch off the power supply or disconnect the product before any maintenance or cleaning operation.

Cleaning the machine at regular intervals prolongs the machine's service life.

Oil and lime may accumulate in the machines washing section. To clean the machine:

Fill the detergent compartment with detergent without loading any dishes into the machine. Select a program that runs at high temperature and start the machine. Alternatively, a dishwasher descaler which is available from most supermarkets can be used.

Cleaning the seals in the machine door

To clean any accumulated residues in the door seals, wipe the seals regularly by using a dampened cloth.

Cleaning the machine

Clean the filters and spray arms at least once a week. Unplug your machine and turn off its tap before starting to clean. Do not use hard materials when cleaning your machine. Wipe with a fine cleaning material and a dampened cloth.

Filters

Check if any food wastes have remained on the coarse and fine filters. If any food waste is found, remove the filters and clean them thoroughly with water under the tap.

- a. Micro Filter
- b. Coarse Filter
- c. Metal

1. To remove and clean the filter combination (a+b), turn it counter clockwise and remove it by lifting upwards. (picture 1)
2. Then pull the coarse filter out of the micro filter. Rinse the filters with water under the tap and reassemble. (picture 2)
3. Pull and remove the metal filter (c) and clean. (picture 3).
4. Reposition the metal filter in the machine.
5. Relocate the filter combination (a+b) into the metal filter and turn it in the direction of the arrow. It is locked when the arrows on the micro filter can be seen on either side. (picture 4)
6. Never use your dishwasher without any filter.
7. Incorrect fitting of the filter will reduce the washing effectiveness.
8. Clean filters are very important in terms of the proper running of the machine.

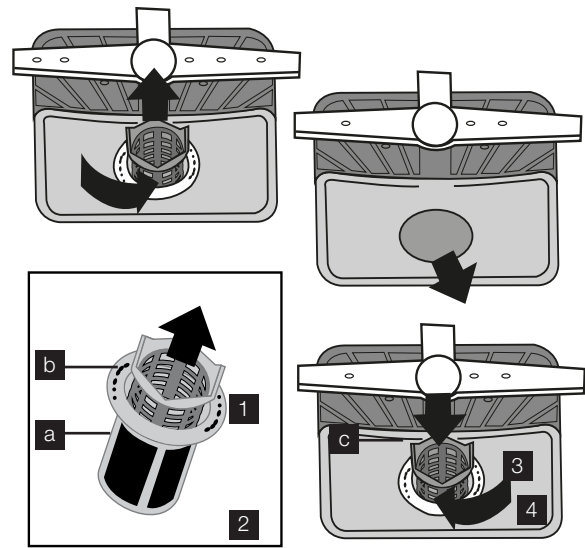

Spray arms

Check whether or not the holes for the upper and lower spray arms are clogged. If there is any clogging, remove the spray arms and clean them under water.

You can remove the lower spray arm by pulling it upwards, while the upper spray arm can be removed by turning the nut to the left.

Be sure that the nut is perfectly tightened when refitting the upper spray arm.

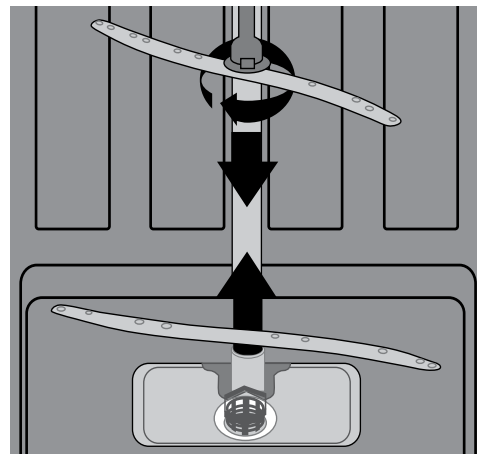

Hose filter

The inlet hose filter reduces contamination (sand, clay, rust etc.) that might be occasionally carried in through the mains water supply or the indoor plumbing, and avoids damage to the dishwasher components. Check the filter and the hose from time to time and clean them if necessary. To clean the filter, first turn off your tap and then remove the hose.

After removing the filter from the hose, clean it under the tap. Insert the cleaned filter back into its place inside the hose. Refit the hose, turn on the tap and check for leaks.

CONSUMPTION VALUES

Program	Water (l)	Energy (kWh)	Duration (min)
Prewash	4.2	0.02	15
Jet Wash 14'	6.6	0.34	14
Quick 30'	10.9	0.74	30
*Eco	12.2	0.65	215
FlexiWash 60°C	15.4	1.43	113
Super 50'	10.7	1.29	50
AutoFlex 30°C-50°C	10.6-17.7	0.92	77-91
AutoFlex 50°C - 60°C	10.9-18.5	1.18	107-122
AutoFlex 60°C- 70°C	12.3-24.6	1.58	109-179
Steam Wash	20.3	1.3	161

Caution: Values above have been tested according to related Standards in laboratory conditions, these values may vary due to environment conditions (mains voltage, water pressure, water inlet temperature and ambient temperatures).

*With this program you have the most efficient use of water and energy consumption for crockery and cutlery for normal soil (This is the standard program for Test Institutes).

Off mode and end of cycle mode tests in accordance with AS/NZS Standards must be carried out with Eco mode brightness level.

Information for Test institutes

For all necessary information for test performance, send an email to dishwasher@standardtest.info and provide the model and PNC number on the rating plate.

POWER HALF LOAD CONSUMPTION VALUES

Program	Water (l)	Energy (kWh)	Duration (min)
Prewash	4.2	0.02	15
Jet Wash 14'	6.6	0.34	14
Quick 30'	10.9	0.74	30
Eco	10.5	0.65	144
FlexiWash 60°C	11.1	0.97	103
Super 50'	10.7	1.23	47
AutoFlex 30°C - 50°C	9.9 - 13.7	1.33	65-85
AutoFlex 50°C - 60°C	10.5 - 14.3	1.11	87-110
AutoFlex 60°C - 70°C	11.9 - 19.9	1.28	89-168
Steam Wash	15.6	1.28	149

TROUBLESHOOTING

If the appliance does not start or it stops during operation, first check if you can solve the problem by yourself with the help of the information in the table or contact an Authorised Service Centre.



WARNING!

Repairs not properly done may result in serious risk to the safety of the user. Any repairs must be performed by qualified personnel.

With some problems, the display shows an alarm code. The majority of problems that can occur can be solved without the need to contact an Authorised Service Centre.

Problem and alarm code	Possible cause and solution
You cannot activate the appliance.	<ul style="list-style-type: none"> • Make sure that the mains plug is connected to the mains socket. • Make sure that there is no damaged fuse in the fuse box.
The program does not start	<ul style="list-style-type: none"> • Make sure that the appliance door is closed. • If the delay start is set, cancel the setting or wait for the end of the countdown.
The appliance does not fill with water. The display shows F5	<ul style="list-style-type: none"> • Make sure that the water tap is open. • Make sure that the pressure of the water supply is not too low. For this information, contact your local water authority. • Make sure that the water tap is not clogged. • Make sure that the filter in the inlet hose is not clogged. • Make sure that the inlet hose has no kinks or bends.
The appliance does not drain the water The display shows F2	<ul style="list-style-type: none"> • Make sure that the sink spigot is not clogged. • Make sure that the filter in the outlet hose is not clogged. • Make sure that the interior filter system is not clogged. • Make sure that the drain hose has no kinks or bends.
The anti-flood device is on. The display shows F1	<ul style="list-style-type: none"> • Close the water tap and contact an Authorised Service Centre
The appliance stops and starts more times during operation.	<ul style="list-style-type: none"> • It is normal. It provides optimal cleaning results and energy savings.
The program lasts too long.	<ul style="list-style-type: none"> • Select the Extra Fast option to shorten the program time. • If the delayed start option is set, cancel the delay setting or wait for the end of the countdown.
The remaining time in the display increases and skips nearly to the end of program time.	<ul style="list-style-type: none"> • This is not a defect. The appliance is working correctly

If the program won't start

- Check if the plug is connected.
- Check your indoor fuses.
- Be sure that the water inlet tap is turned on.
- Be sure that you have closed the machine door.
- Be sure that you switched off the machine by pressing the Power On / Off button.
- Be sure that the water inlet filter and the machine filters are not clogged.

If detergent residues are left in the detergent compartment

- Detergent has been added when the detergent compartment was wet.

If water is left inside the machine at the end of the program

- The water drain hose is clogged or twisted.
- The filters are clogged.
- The program is not finished yet.

If the machine stops during a wash operation

- Power failure.
- Water inlet failure.
- Program can be on standby mode.

If shaking and hitting noises are heard during a wash operation

- Dishes placed incorrectly.
- Spray arm hitting the dishes.

If there are partial food wastes left on the dishes

- Dishes placed incorrectly into the machine, sprayed water did not reach related places.
- Basket overly loaded.
- Dishes leaning against one another.
- Very small amount of detergent added.
- An unsuitable, rather weak wash program selected.
- Spray arm clogged with food wastes.
- Filters clogged.
- Filters incorrectly fitted.
- Water drain pump clogged.

If there are whitish stains on the dishes

- A very small amount of detergent is being used.
- Rinse aid dosage setting at a very low level.
- A detergent without phosphate used; try one that contains phosphate.

If the dishes are not dry

- A program without a dry operation selected.
- Rinse aid dosage set too low
- Dishes unloaded too soon

If there are rust stains on the dishes

- Stainless-steel quality of the dishes washed is not dishwasher grade.
- High level of salt in the wash water.
- Poor mains grounding.

If the 'Turn on the Tap' warning shows during operation

When you see "Turn on the tap" warning;

- Make sure water is not cut off.
- Make sure the tap is turned on.
- Call the authorised service if there is water and the tap is turned on.

Call an Authorised Service Centre if the problem still persists after the controls or in case of any malfunction not described above.

When you see the messages above, error codes are stated before definitions. You can find these details on page 27 of your manual.

TROUBLESHOOTING (CONTINUED)

Error codes, cause and solution

Error code	Possible cause and solution	Control
F1	Overfill	<ul style="list-style-type: none"> • Power off your machine and close the tap. • Contact the customers services centre.
F2	Not draining	<ul style="list-style-type: none"> • Water discharge hose is clogged. • Water drainage hose kinked, check installation. • The filters of your machine might be clogged. • Power off–on your machine and activate the program cancellation command. • If the error continues, contact the Customer Care Centre.
F3	Inlet valve faulty	<ul style="list-style-type: none"> • Close the tap. • Contact the Customer Care Centre.
F5	Inadequate water supply	<ul style="list-style-type: none"> • Make sure the water tap is fully open and that there is mains water available. • Water inlet hose kinked, check installation. • Close the water tap, disconnect the hose from the tap and clean the filter at the connection. • Restart your machine, contact the service if the error resumes.
F6	Faulty heater sensor	<ul style="list-style-type: none"> • Contact the Customer Care Centre.
F7	Over temperature	<ul style="list-style-type: none"> • Contact the Customer Care Centre.
F8	Heating error	<ul style="list-style-type: none"> • Contact the Customer Care Centre.
F9	Diverter valve faulty	<ul style="list-style-type: none"> • Contact the Customer Care Centre.
FE	Power supply problem	<ul style="list-style-type: none"> • Contact the Customer Care Centre.

TECHNICAL SPECIFICATIONS

ESF6768KXA	
Technical specifications	
Capacity	15 place settings
Height with worktop	850mm
Height (without worktop)	820mm
Width	598mm
Depth	598mm
Net weight	62kg
Electricity input	220–240V, 50Hz
Total power	1900W
Current	10A
Water supply pressure	0.03 MPa (0,3 bar) – 1 MPa (10 bar)
Water supply	Hot or Cold water, max 60°C, 10L/min

INSTALLATION

Positioning the machine

When considering the location for the dishwasher, ensure that there is adequate space to enable loading and unloading of the dishes.

- Do not put your machine in any location where the ambient temperature can fall below 5°C.
- Before positioning, take the machine out of its packaging by following the warnings located on the package.
- Position the machine close to a water tap and drain. You need to position your machine, taking into consideration that its connections will not be altered once they are made.
- Do not grip the machine by its door or panel in order to move it.
- Take care to leave a certain clearance from all sides of the machine so that you can comfortably move it back and forth during cleaning.
- Make sure that the water inlet and outlet hoses do not get squeezed while positioning the machine. Also, make sure that the machine does not stand on the electrical cable. Adjust the machine's feet so that it is level and stable. Proper positioning of the machine ensures problem-free opening and closing of its door.
- If the door of your machine does not close properly, check if the machine is stable on the floor; if not, adjust the feet and ensure it is level and stable.

Water connection

Ensure that the indoor plumbing is suitable for installing a dishwasher and complies with AS/NZS 3500.1. Also, we recommend that you fit a filter at the entrance of your place or apartment so as to avoid any damage to your machine because of any contamination (sand, clay,

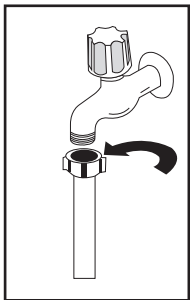

rust etc) that might be occasionally carried in through the main's water supply or the indoor plumbing, and to avoid problems of staining and formation of deposits after washing.

Water inlet hose

Do not use the water inlet hose of your old machine, you must use the new water inlet hose supplied with your machine. Before connecting the water inlet hose to the water tap, ensure clean water is flowing from the tap before making the connection. Connect the water inlet hose directly to the water inlet tap. The pressure supplied by the tap should be at a minimum of 0.03 MPa and at a maximum of 1 MPa. If the water pressure is above 1 MPa, a pressure-relief valve should be installed.



WARNING

Only turn the locking nut to secure hose – do not turn the hose.

- The first time you use the appliance, make sure that there is no leakage.
- The water inlet hose has a safety valve and a sheath with an inner mains cable.
- After the connections are made, the tap should be turned on fully and checked for water tightness. For the safety of your machine, make sure to always turn off the water inlet tap after each wash program is finished.

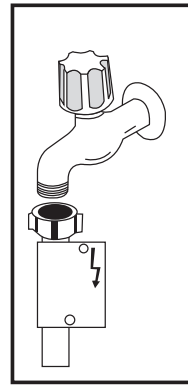

WARNING

NOTE: Aquastop inlet hose has components using 240V. Do not cut Aquastop inlet hose. Do not let it get folded, twisted, kinked or crushed.



WARNING

NOTE: A water tempering valve is required if the water temperature is over 60°C.



CAUTION

Always use new hoses when you connect the appliance to the water supply. Old hoses must not be used. The water inlet hose must be examined at an interval of twelve months for deterioration and replaced if necessary.

In order to pass the safety valve through the kitchen cabinets, an opening of at least 45mm x 90mm is needed.

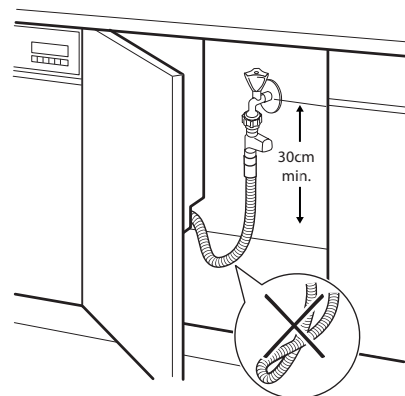

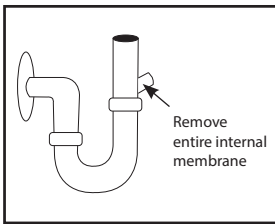

Water drain hose

If you connect the water drain hose to a trap spigot under the sink, remove the plastic membrane. If you do not remove the entire membrane, remaining food can cause blockage in

the drain hose spigot. Ensure a hose clamp is used to secure the hose to the spigot.

Water drain hose

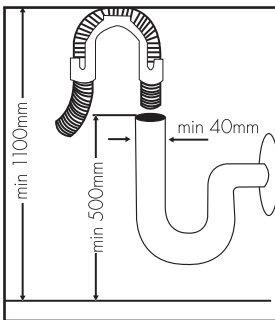

The water drain hose can be connected either directly to the water drain hole or to the sink outlet spigot. Using a hose hook (if available), the water can be drained directly into the sink by positioning the hose hook over the edge of the sink.

This connection should be at a minimum of 50cm and at a maximum of 110cm above the base of the dishwasher.



WARNING

Maximum drain hose length is 4m. Longer hose length will prevent correct draining, and result in poor wash performance.

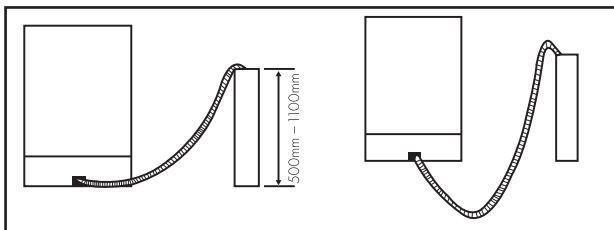

✓
(correct)

✗
(incorrect)



WARNING

Electrical Connection

The plug of your machine should be connected to an earthed outlet that supplies suitable voltage and current. If there is no earthing installation, have a competent electrician carry out an earthing installation. In case of usage without earthing installed, our company will not be responsible for any loss of usage that might occur.

The indoor fuse current value should be 10-16 A.

Your machine is designed for 220-240 V. The machine should not be plugged in during installation.

- Always use the molded plug supplied with your machine.
- Running at low voltage will cause a decline in washing quality.
- The machine's electrical cable should be replaced by an authorised service or an authorised electrician only. Failure to do so may lead to accidents.
- For safety purposes, always make sure to disconnect the plug when a wash program is finished.
- In order not to cause an electric shock, do not unplug when your hands are wet.
- When disconnecting your machine from the mains supply, always pull from the plug. Never pull the cord itself.

Fitting the machine undercounter

If you wish to fit your machine undercounter, check whether you have sufficient space under your countertop and whether the wiring-plumbing is suitable to do so.

1. To ensure the stability of the dishwasher for an underbench installation, if the underbench dimension is greater than 820mm, any gap between the dishwasher and the underside of the benchtop should be bridged with a packing piece. This may be achieved by wedging a piece of timber between the dishwasher and the benchtop as shown
2. If required, remove the worktop as shown in the illustration.
3. To remove the worktop, remove the screws that hold the worktop which are located at the rear of the machine; then push the front panel 1cm from the front

INSTALLATION (CONTINUED)

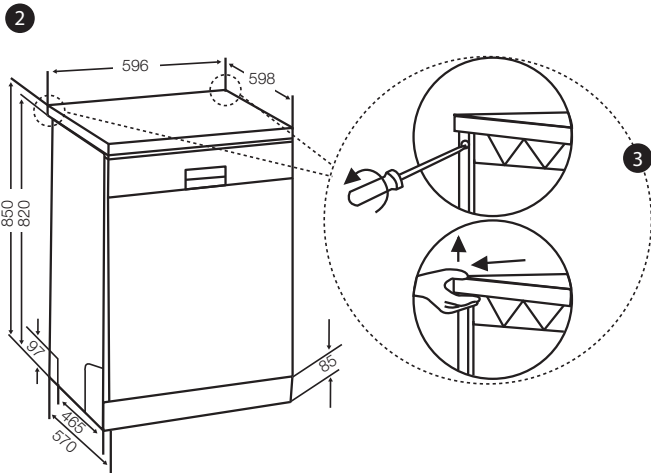
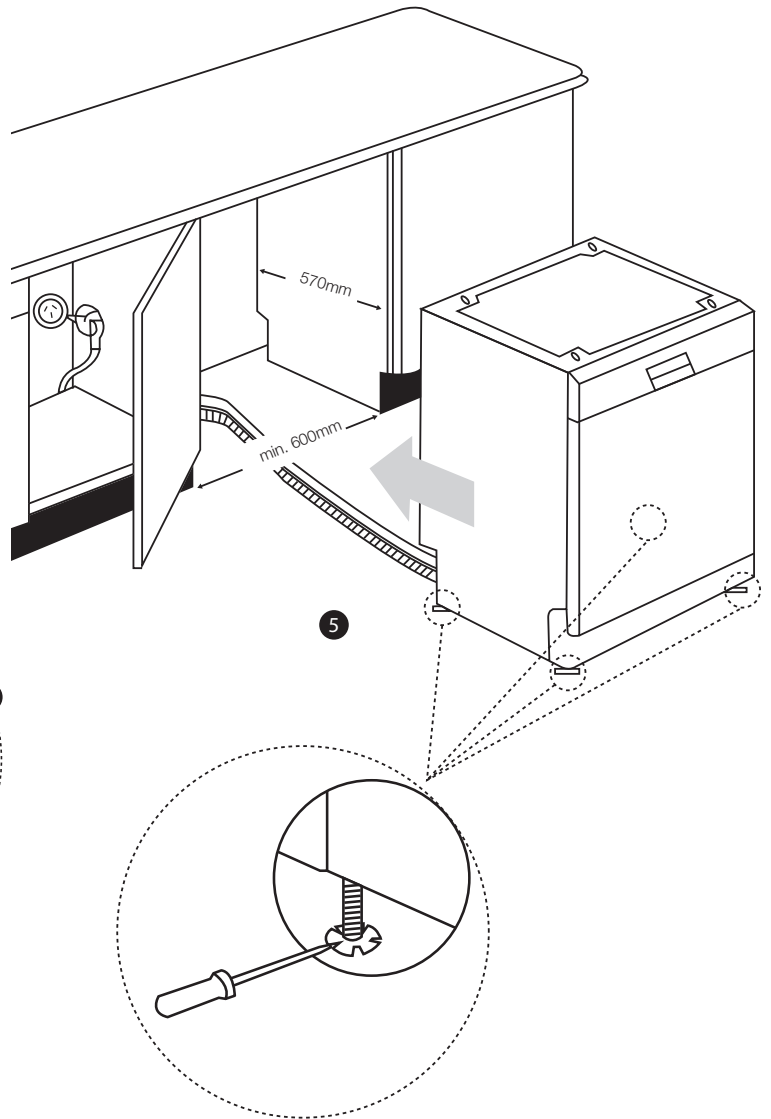
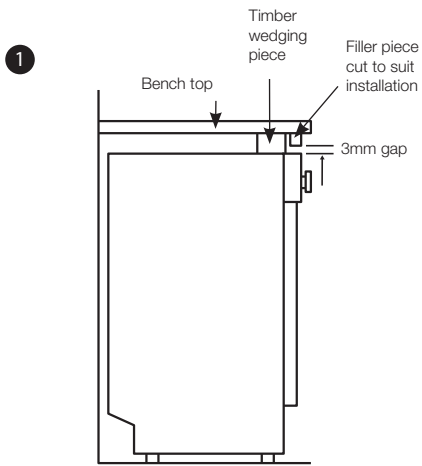

1. towards the rear and lift it.
2. Adjust the machine feet according to the slope of the floor.
3. Fit your machine by pushing it undercounter without letting the hoses get crushed or bent.

⚠ WARNING

After removal of worktop, ensure the opening for the dishwasher is according to the following dimensions.

This document sets out the terms and conditions of the product warranties for Electrolux Appliances. It is an important document. Please keep it with your proof of purchase documents in a safe place for future reference should there be a manufacturing defect in your Appliance. This warranty is in addition to other rights you may have under the Australian Consumer Law.

1. In this warranty:

- (a) 'ACL' or 'Australian Consumer Law' means Schedule 2 to the Competition and Consumer Act 2010;
- (b) 'Appliance' means any Electrolux product purchased by you and accompanied by this document;
- (c) 'ASC' means Electrolux's authorised serviced centres;
- (d) 'Electrolux' is the brand controlled by Electrolux Home Products Pty Ltd of 163 O'Riordan Street, Mascot NSW 2020, ABN 51 004 762 341 in respect of Appliances purchased in Australia and Electrolux (NZ) Limited (collectively "Electrolux") of 3-5 Niall Burgess Road, Mount Wellington, in respect of Appliances purchased in New Zealand;
- (e) 'Warranty Period' means the period specified in clause 3 of this warranty;
- (f) 'you' means the purchaser of the Appliance not having purchased the Appliance for re-sale, and 'your' has a corresponding meaning.

2. Application: This warranty only applies to new Appliances, purchased and used in Australia or New Zealand and is in addition to (and does not exclude, restrict, or modify in any way) other rights and remedies under a law to which the Appliances or services relate, including any non-excludable statutory guarantees in Australia and New Zealand.

3. Warranty Period: Subject to these terms and conditions, this warranty continues for in Australia for a period of 24 months and in New Zealand for a period of 24 months, following the date of original purchase of the Appliance.

4. Repair or replace warranty: During the Warranty Period, Electrolux or its ASC will, at no extra charge if your Appliance is readily accessible for service, without special equipment and subject to these terms and conditions, repair or replace any parts which it considers to be defective. Electrolux may, in its absolute discretion, choose whether the remedy offered for a valid warranty claim is repair or replacement. Electrolux or its ASC may use refurbished parts to repair your Appliance. You agree that any replaced Appliances or parts become the property of Electrolux.

5. Travel and transportation costs: Subject to clause 7, Electrolux will bear the reasonable cost of transportation, travel and delivery of the Appliance to and from Electrolux or its ASC. Travel and transportation will be arranged by Electrolux as part of any valid warranty claim.

6. Proof of purchase is required before you can make a claim under this warranty.

7. Exclusions: You may not make a claim under this warranty unless the defect claimed is due to faulty or defective parts or workmanship. This warranty does not cover:

- (a) light globes, batteries, filters or similar perishable parts;
- (b) parts and Appliances not supplied by Electrolux;
- (c) cosmetic damage which does not affect the operation of the Appliance;
- (d) damage to the Appliance caused by:

- (i) negligence or accident;
- (ii) misuse or abuse, including failure to properly maintain or service;
- (iii) improper, negligent or faulty servicing or repair works done by anyone other than an Electrolux authorised repairer or ASC;
- (iv) normal wear and tear;
- (v) power surges, electrical storm damage or incorrect power supply;
- (vi) incomplete or improper installation;
- (vii) incorrect, improper or inappropriate operation;
- (viii) insect or vermin infestation;
- (ix) failure to comply with any additional instructions supplied with the Appliance;

In addition, Electrolux is not liable under this warranty if:

- (a) the Appliance has been, or Electrolux reasonably believes that the Appliance has been, used for purposes other than those for which the Appliance was intended, including where the Appliance has been used for any non-domestic purpose;
- (b) the Appliance is modified without authority from Electrolux in writing;
- (c) the Appliance's serial number or warranty seal has been removed or defaced

8. How to claim under this warranty: To enquire about claiming under this warranty, please follow these steps:

- (a) carefully check the operating instructions, user manual and the terms of this warranty;
- (b) have the model and serial number of the Appliance available;
- (c) have the proof of purchase (e.g. an invoice) available;
- (d) telephone the numbers shown below.

9. Australia: For Appliances and services provided by Electrolux in Australia: Electrolux goods come with guarantees that cannot be excluded under the Australian Consumer Law. You are entitled to a replacement or refund for a major failure and for compensation for any other reasonably foreseeable loss or damage. You are also entitled to have the Appliance repaired or replaced if the Appliance fails to be of acceptable quality and the failure does not amount to a major failure. 'Acceptable quality' and 'major failure' have the same meaning as referred to in the ACL.

10. New Zealand: For Appliances and services provided by Electrolux in New Zealand, the Appliances come with a guarantee by Electrolux pursuant to the provisions of the Consumer Guarantees Act, the Sale of Goods Act and the Fair Trading Act. Where the Appliance was purchased in New Zealand for commercial purposes the Consumer Guarantee Act does not apply.

11. Confidentiality: You accept that if you make a warranty claim, Electrolux and its agents including ASC may exchange information in relation to you to enable Electrolux to meet its obligations under this warranty.

Important Notice

Before calling for service, please ensure that the steps listed in clause 8 above have been followed.

<p style="text-align: center;">FOR SERVICE</p> <p>or to find the address of your nearest authorised service centre in Australia PLEASE CALL 13 13 49 For the cost of a local call (Australia only)</p>	<p style="text-align: center;">AUSTRALIA</p> <p style="text-align: center;">ELECTROLUX HOME PRODUCTS 163 O'Riordan Street, Mascot NSW 2020 electrolux.com.au</p>	<p style="text-align: center;">FOR SPARE PARTS</p> <p>or to find the address of your nearest spare parts centre in Australia PLEASE CALL 13 13 50 For the cost of a local call (Australia only)</p>
<p style="text-align: center;">FOR SERVICE</p> <p>or to find the address of your nearest authorised service centre in New Zealand PLEASE CALL 0800 10 66 10 (New Zealand only)</p>	<p style="text-align: center;">NEW ZEALAND</p> <p style="text-align: center;">ELECTROLUX (NZ) Limited 3-5 Niall Burgess Road, Mount Wellington electrolux.co.nz</p>	<p style="text-align: center;">FOR SPARE PARTS</p> <p>or to find the address of your nearest spare parts centre in New Zealand PLEASE CALL 0800 10 66 20 (New Zealand only)</p>

Electrolux Home Products Australia

telephone: 1300 363 640
fax: 1800 350 067
email: customercare@electrolux.com.au
web: electrolux.com.au



Electrolux Home Products New Zealand

telephone: 0800 436 245
fax: 0800 225 088
email: customercare@electrolux.co.nz
web: electrolux.co.nz



To add a touch of professional inspiration to your home, visit electrolux.com.au or electrolux.co.nz

electrolux.com.au



or electrolux.co.nz



P/No. 52217762-A.

© 2019 Electrolux Home Products Pty Ltd.
EMAN_ESF6768KXA_11Apr19

