

Contents

1 Instructions	8
1.1 Introduction	8
1.2 This user's manual	8
1.3 Intended use	8
1.4 Manufacturer's liability	9
1.5 Identification plate	9
1.6 Disposal	9
2 Description	10
2.1 Product Description	10
3 Use	11
3.1 Before first use	11
3.2 First use	12
3.3 How to access the settings menu	12
3.4 How to make coffee	14
4 Cleaning and maintenance	19
4.1 Warnings	19
4.2 Cleaning the drip coffee maker	19
4.3 Cleaning the parts of the drip coffee maker	19
4.4 Descaling	20
4.5 What to do if...	22

Important Safeguards

WARNING: If the instructions contained in this manual are not followed precisely, fire or explosion may result causing property damage, personal injury or death.



READ AND SAVE THESE INSTRUCTIONS - Your safety and the safety of others are very important.

We have provided many important safety messages throughout this manual and on the appliance.

Read all the instructions before using the appliance and always obey all safety messages.

WARNING



- To reduce the risk of fire or electric shock, do not remove the cover (or back).
- No user-serviceable parts inside!
- Repair should be done by authorized service personnel only.



Important Safeguards



RECOGNIZE SAFETY INFORMATION

This is a safety alert symbol. This symbol alerts you to potential hazards that can result in severe personal injury or death.

UNDERSTAND SIGNAL WORDS

A signal word - DANGER, WARNING or CAUTION - is used with the safety alert symbol. DANGER denotes the most serious hazards. It means you could be killed or seriously injured if you do not immediately follow the instructions.

WARNING means you could be killed or seriously injured if the instructions are not followed. CAUTION indicates a potentially hazardous situation, which, if not avoided, could result in minor to moderate injury.

WARNING



- This appliance is intended for use in the home only.
- Use this appliance only for its intended purpose. The manufacturer cannot be held liable for damage caused by improper use of this appliance.
- This appliance complies with current safety regulations. Improper use of this appliance can result in personal injury and material damage.
- Read all the instructions before installing or using the appliance for the first time.
- Keep these operating instructions in a safe place and pass them on to any future user.

The safety messages will inform you of potential hazards, on how to avoid the risk of injury and what can occur if the instructions are not followed.

IMPORTANT: Observe all codes and ordinances in force.

WARNING: For your safety, the instructions contained in this manual must be followed to minimize the risk of fire or explosion and to prevent property damage, personal injury or death.

Do not store or use gasoline or other flammable vapors, liquids or materials near this or any other appliance.



NOTE: This appliance is NOT designed for installation in manufactured (mobile) homes or in recreational vehicles (RVs).

DO NOT install this appliance outdoors.

Important Safeguards



WARNING



When using electrical appliances, basic safety precautions should always be followed to reduce the risk of fire, electric shock, and/or injury to persons including the following:

NE

Follow all safety precautions to ensure safe use of the appliance.

- Before using the appliance, read this user manual carefully.
- Do not use the appliance outdoors.
- This appliance is for household use only.
- Do not use the appliance for other than its intended use.
- Do not allow children to use the appliance.
- Children should not play with the appliance. Keep the appliance out of the reach of children.
- Close supervision is necessary when any appliance is used by or near children.
- Turn off the appliance immediately after use.
- Do not leave the appliance unattended while it is running.
- Disconnect the appliance from the wall outlet before assembly, disassembly, cleaning and after each use.
- To disconnect, turn any control to the off position, then remove plug from wall outlet.
- Unplug from outlet when either the appliance or display clock is not in use, and before cleaning. Allow to cool before putting on or taking off parts, and before cleaning the appliance.
- Do not use appliance for other than intended use.
- To protect against fire, electrical shock and personal injury, do not immerse the appliance, the power cord or plug in water or any other liquid.
- Do not touch the appliance or the plug with wet hands.
- Never try to extinguish a flame/fire with water: turn off the appliance, unplug it from the outlet and cover the flame with a lid or a fire blanket.
- Do not use the appliance if the power cord or plug is damaged or if the appliance has been dropped or damaged in any way.
- Do not let cord hang over edge of table or counter, or touch hot surfaces.
- Do not operate any appliance with a damaged cord or plug or after the appliance malfunctions, or has been damaged in any manner. Return appliance to an authorized service facility for examination, repair or adjustment.
- Make sure the power cord does not come in contact with sharp edges.
- Do not pull on the cord to remove the plug from the socket.
- Do not place the appliance on or near switched-on gas or electric burners, inside an oven, or near heat sources.



Important Safeguards

- Do not touch hot surfaces. Use handles and knobs.
- Do not place the appliance near faucets or sinks.
- Never attempt to repair the appliance yourself or without the help of a qualified technician. Failing to do this will void the warranty.
- In case of malfunction, have the appliance repaired by a qualified technician.
- Do not make any changes to the appliance.
- Use only original spare parts from the manufacturer. The use of spare parts not recommended by the manufacturer may cause fire, electric shock or injury to persons.
- Place the drip coffee maker on a flat, dry surface.
- Avoid wetting or spraying liquid on the drip coffee maker. In case of contact with liquid, immediately unplug the cord from the electrical outlet and dry thoroughly: Risk of electric shock!
- Do not use abrasive cleaners or sharp objects to clean the drip coffee maker.
- The use of an accessory not evaluated for use with this appliance may cause injuries.
- The carafe is designed for use with this appliance. It must never be used on a range top.
- Do not use the carafe if damaged or if the handle has come loose.
- Do not use a cracked carafe or a carafe having a loose or weakened handle.
- Do not clean carafe with cleansers, steel wool pads, or other abrasive material.
- Make sure the lid is firmly inserted on the carafe.
- Do not place the carafe on a burner or in a microwave oven.
- Do not place the hot carafe on a cold or wet surface.
- Fill the water tank before connecting the plug to an electrical outlet.
- Do not install the appliance in environments with a temperature less than or equal to 0°C.

For this appliance

- The drip coffee maker shall not be placed in a cabinet when in use.
- Leave a space of 10 cm around the drip coffee maker.
- Do not use the drip coffee maker without water in the tank.
- Use cold and possibly filtered water. Do not use other liquids.
- Make sure the lid is firmly closed.
- Risk of scalding! Do not open the lid during the coffee preparation cycle.
- Risk of scalding! Do not touch hot surfaces with your hands: use the handles and buttons.
- Risk of scalding! The heating element surface is subject to residual heat after use. Do not touch.
- Do not use the drip coffee maker in combination with parts or accessories from other manufacturers.

SAVE THESE INSTRUCTIONS

Important Safeguards



Electrical Cord:

a) A short power-supply cord (or detachable power-supply cord) is provided to reduce risks resulting from becoming entangled in or tripping over a longer cord.

b) Longer detachable power-supply cords or extension cords are available and may be used if care is exercised in their use.

c) If a long detachable power-supply cord or extension cord is used:

1. The marked electrical rating of the detachable power-supply cord or extension cord should be at least as great as the electrical rating of the appliance;
2. If the appliance is of the grounded type, the extension cord should be a grounding-type 3-wire cord; and
3. The longer cord should be arranged so that it will not drape over the counter top or table top where it can be pulled on by children or tripped over.

- Plug the cord into a grounded socket of the correct current.
- Do not tamper with the grounding.
- Do not use an adapter.
- Do not use an extension cord.
- Failure to observe these warnings may result in death, fire or electric shock.

SAVE THESE INSTRUCTIONS



Important Safeguards

1 Instructions

1.1 Introduction

Key information for the user:

Warnings



General information about the user manual, safety and final disposal.

Description



Description of the appliance.

Use



Information on using the appliance.

Cleaning and maintenance



Information for proper cleaning and maintenance.



Safety warning



Information



Suggestion

1.2 This user's manual

This user's manual is an integral part of the appliance and must be kept intact and available to the user throughout its life cycle.

1.3 Intended use

- The appliance is for indoor use only.
- The appliance is intended solely for household-type use.
- The appliance may be used to prepare drip coffee. Any other use is inappropriate. Do not use the appliance for purposes other than its intended use.



The California Safe Drinking Water and Toxic Enforcement Act requires the Governor of California to publish a list of substances known to the State of California to cause cancer, birth defects or other reproductive harm, and requires businesses to warn customers of potential exposure to such substances.



Warning

- This product contains a chemical known by the State of California to cause cancer, birth defects or other reproductive harm.
- This appliance can cause low-level exposure to some of the substances listed, including benzene, formaldehyde, carbon monoxide, toluene, and soot.

Important Safeguards



1.4 Manufacturer's liability

The manufacturer accepts no liability for damage to persons and property caused by:

- using the appliance in ways other than those provided;
- not reading the user's manual;
- tampering with any part of the appliance;
- using non-original parts;
- ignoring safety warnings.

1.5 Identification plate

The identification plate lists the technical data, serial number and brand name. The identification plate must never be removed.

1.6 Disposal



Power voltage Risk of electric shock

- Unplug the appliance.
- Unplug the cord from the wall outlet.
- **Old electrical equipment must not be disposed of with household waste!** In accordance with the law in force, electrical appliances at the end of their life should be taken to separate collection facilities for electrical and electronic waste. This is so that valuable materials from old appliances can be recycled and the environment can be protected. For more information, please contact your local authorities or recycling center employees.

Note that non-polluting and recyclable materials are used for packaging the appliance.

- Dispose of the packaging materials at appropriate differentiated waste collection centers.



Plastic packaging Risk of suffocation

- Do not leave the packaging or any part of it unattended.
- Do not allow children to play with the plastic packaging bags.



Description

2 Description

2.1 Product Description

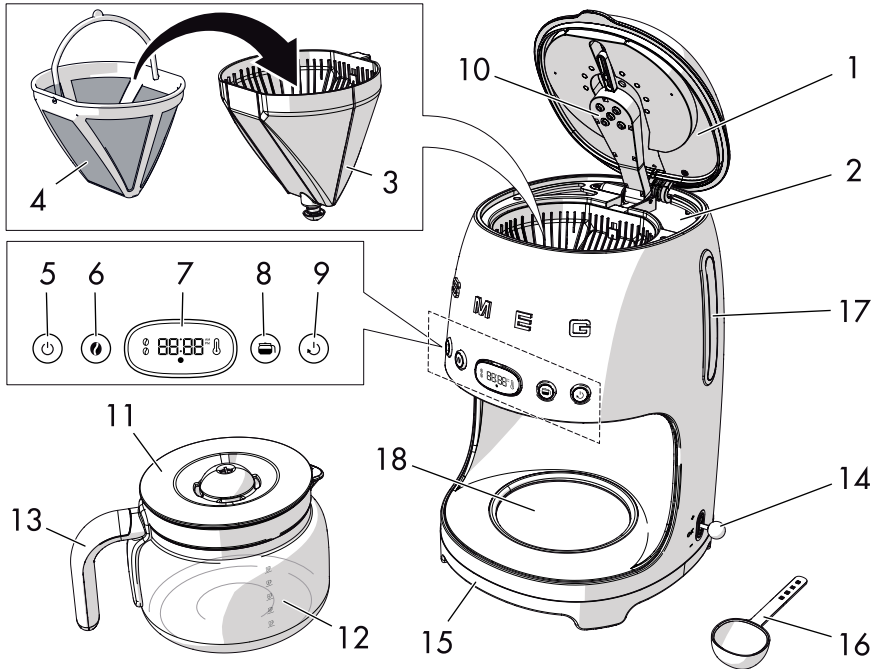

Drip coffee maker

- | | |
|---|--|
| 1 Lid | 10 Grouphead |
| 2 Water tank (1.4 liters) | 11 Carafe lid |
| 3 Filter holder with anti-drip valve system | 12 Carafe (10 cups) |
| 4 Permanent filter | 13 Carafe handle |
| 5 ON/OFF button | 14 Time/Timer setting lever |
| 6 AROMA setting button | 15 Base and non-slip feet |
| 7 Time/settings display | 16 Measuring scoop |
| 8 4 CUPS function button | 17 Tank water level indicator (maximum 1.4 liters) |
| 9 AUTO START button | 18 Keep Warm plate |



3 Use

3.1 Before first use

1. Remove all labels and stickers from the drip coffee maker.
2. Thoroughly wash and dry the drip coffee maker's parts (see "4 Cleaning and maintenance").
3. Lift the lid (1) by pulling up on the tab (2).

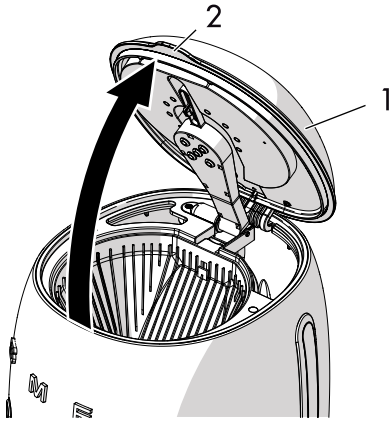

To make it easier to fill the water tank, check that the lid is completely open.

4. Fill the tank (3) with cold and clean water, taking care not to exceed the maximum level shown on the level indicator (4) (1.4 liters).

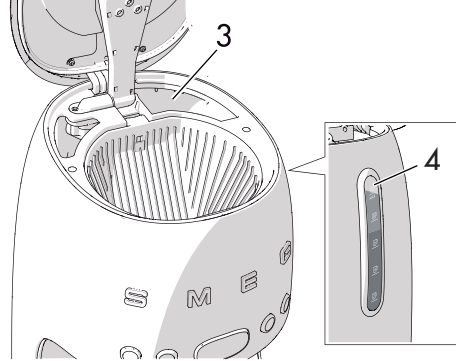

Risk of damage

- Do not use the drip coffee maker without water in the tank.
- Use only cold and clean water inside the tank.
- Do not use any liquids other than water.



The parts that may come into contact with food are made of materials that comply with all legal provisions in force.



3.2 First use

1. Insert the plug into an electrical socket.
2. Press the ON /OFF (⏻) button. The display shows the flashing symbols.

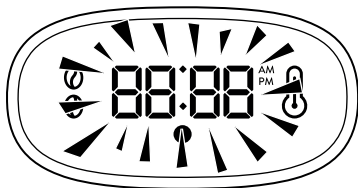

3. Set the time using the lever (1).
4. Set the hour value by moving the lever up (+) to increase the value or down (-) to decrease the value.
5. Confirm the value by placing the lever in the central position and pressing it (OK).

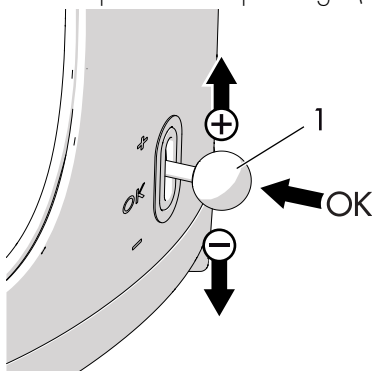

6. Set the minute value following the same procedure.

7. After confirming the minute setting, the appliance activates the **CLOCK** mode.



The first time the appliance is powered on, by default the clock will be in the 12-hour format with AM/PM indicated.

To change the time format, please refer to the section "Clock format settings menu".

3.3 How to access the settings menu

Some settings can be customized:

- SE01: Sets the clock format
- SE02: Sets how hard/soft the water is
- SE03: Activates/deactivates audible signals

Open the settings menu by pressing and holding buttons (⏻) and (🔌) at the same time for 3 seconds.

To exit the settings menu, press any button.



Clock format settings menu

The clock format can be set after turning the appliance on for the first time:

1. Open the settings menu and select **SE01**.
2. Move the lever to select the desired format (12-hour or 24-hour clock).
3. Move the lever to the central position and press **(OK)** to confirm.
The format will blink for 2 seconds and the setting will then be saved.



The clock format is selected only once and is then saved from that moment on.

How to change the time:

1. Make sure that the desired clock format (12h or 24h) has been set as described above.
2. Keep the lever pressed in the central position for 3 seconds: the display will start to flash.
3. Change the hour and minute as indicated in section "3.2 First use".

Water settings menu (hard/soft water)

The type of water being used can be set by selecting one of the three available levels: **HARD**, **MEDIUM** and **SOFT**.

1. Open the settings menu and select **SE02**:
By default, the screen will show **HA02** (medium).
2. Move the lever up **(+)** or down **(-)** to set the desired level: **HA01** (soft), **HA02** (medium) and **HA03** (hard).
3. Move the lever to the central position and press **(OK)** to confirm.
The selection will blink for 2 seconds and the setting will then be saved.

Audible signal settings

You can disable the audible signals as follows:

1. Open the settings menu and select **SE03**.
2. Move the lever up or down until you see the word **OFF** on the display.
3. Move the lever to the central position and press **(OK)** to confirm.
The selection will blink for 2 seconds and the setting will then be saved.



To enable audible signals:

1. Open the settings menu and select **SE03**.
2. Move the lever up or down until you see the word **ON**.
3. Move the lever to the central position and press **(OK)** to confirm.
The selection will blink for 2 seconds and the setting will then be saved.

Rinsing the internal circuits

Rinse the internal circuits once the tank is full:

1. Place the carafe (**6**) on the Keep Warm plate (**7**) **WITHOUT** adding ground coffee to the filter.

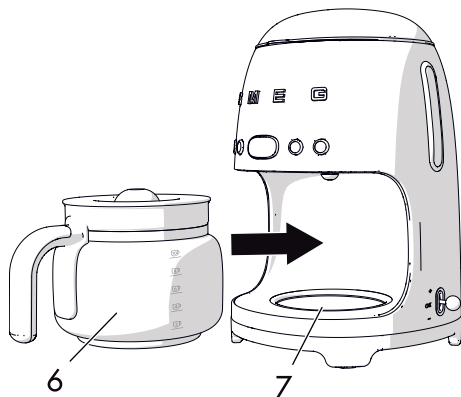

2. Press the **ON /OFF** (power button) button.
3. Wait for the cycle to complete and empty the carafe.
4. Repeat the cycle: the appliance is now ready for use.

3.4 How to make coffee

1. Fill the water tank as indicated in the paragraph "3.1 Before first use".
2. Keep the water tank lid (**1**) raised and insert the permanent filter (**2**) into the filter holder (**3**).

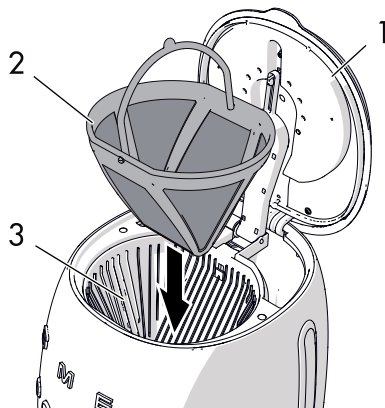

3. Add the desired quantity of coffee according to the number of cups to be prepared using the supplied measuring scoop (**4**).

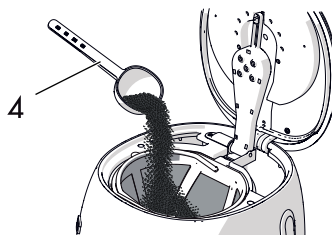

The permanent filter allows you to prepare drip coffee without using paper filters. However, according to your own preference, a paper filter #4 can be used instead.



Place the paper filter inside the filter holder and add the desired amount of coffee.

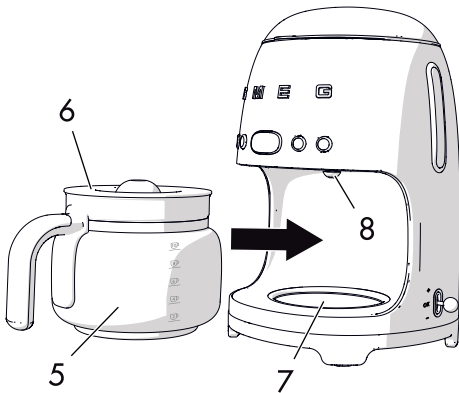

- One level scoop of ground coffee is approximately equivalent to one cup. However, the amount of ground coffee to be used may vary according to personal taste.
- Use good quality medium ground coffee.

4. Close the lid (1) by lowering the tab.
5. Place the carafe (5) with the lid (6) on the special Keep Warm plate (7). Make sure that the lid fits perfectly with the anti-drip valve (8).



6. Press the ON/OFF  button to activate **BREW** mode: the LED on the ON/OFF  button lights up and flashes quickly for the entire time that the coffee brews.



Steam coming out during coffee brewing is completely normal.



Risk of scalding

- Do not open the water tank lid during the coffee brewing cycle.
7. The coffee brewing operation can be stopped at any time by pressing the ON/OFF  button.





Warning

- Do not open the lid of the drip coffee machine at the end of the brewing cycle. Wait at least 3 minutes after the brewing cycle has finished before opening the lid.
- After 3 minutes, you can remove and clean the filter and refill the water tank in order to start a new brewing cycle.



Use

i

- Pressing all the buttons except the **ON/OFF**  button does not affect the coffee preparation and brewing operation in any way.
- If the **ON/OFF**  button is not pressed, the coffee continues to brew according to the automatic setting for filling the entire carafe (10 cups).





- The filter holder and permanent filter may be hot even after the coffee has been dispensed. Take care before removing them.
- The base of the carafe may be very hot after coffee has been dispensed. Take care when removing it and make sure you do not place the carafe on a heat-sensitive surface.



KEEP WARM mode

The **KEEP WARM** mode is activated automatically after the coffee has been brewed, keeping the Keep Warm plate on for 60 minutes.

In this way, the coffee will be hot for 60 minutes after the coffee has been brewed.

In **KEEP WARM** mode, the LED of the **ON/OFF**  button flashes slowly, the **KEEP WARM**  icon lights up on the display.

The **ON/OFF**  button turns off automatically when the **KEEP WARM** mode ends.

You can manually end the **KEEP WARM** mode at any time by pressing the **ON/OFF**  button: the LED of the **ON/OFF**  button and the **KEEP WARM**  icon go out.

i

The **KEEP WARM** mode cannot be activated if the **BREW** mode is stopped manually or if the **4 CUPS** mode is active.





Risk of scalding

- The plate remains hot after the coffee has been brewed: be careful not to touch it while extracting the carafe.









AROMA setting

This setting allows you to choose the intensity of the aroma for your coffee from two levels: **DELICATE AROMA** or **INTENSE AROMA**.

The appliance is set by default to **DELICATE** aroma: the LED of the aroma setting  button is off, and on the display only the lower bean of the  icon is selected.

To change the setting:

1. Press the **AROMA**  setting button to select **INTENSE** aroma: the LED of the **AROMA**  setting button lights up and on the display both the beans of the icon  are selected.
2. Press the **AROMA**  setting button again to select **DELICATE** aroma: the LED of the **AROMA**  setting button goes out and the selection of the upper bean of the icon  disappears from the display.







The desired aroma settings are saved for the next time coffee is brewed.

4 CUPS function setting

This function allows you to dispense a small amount of coffee, corresponding to about 4 cups.

The setting is **OFF** by default.

To select the **4 CUPS** function:

1. Press the appropriate button  to set it to **ON**: the LED of the **4 CUPS**  function button lights up.
2. Press the button  again to set this function to **OFF**: the LED on the button  goes out.





If the **4 CUPS** mode has been selected, the **KEEP WARM** mode cannot be activated.







Setting the time for AUTO START mode

Use this setting to program the appliance to switch on automatically to prepare the drip coffee at a time selected by the user.

To set the auto start time, proceed as follows:

1. Check that the displayed time is correct. If not, set the current time as described in the paragraph "3.2 First use".
2. Hold down the  button for 3 seconds to set the time for the **AUTO START** mode: the LED of the  button and the time display (HH:MM) start to flash.
3. Use the lever, moving it up (+) or down (-) to set the desired time.
4. Move the lever to the central position and press **(OK)** to confirm.
5. Once the settings are saved, the programmed **AUTO START** time will be automatically saved and maintained until a new setting is selected to replace it.

AUTO START mode

1. Press the **AUTO START**  button to activate the **AUTO START** mode: the LED of the **AUTO START**  button will light up and the hours and minutes set for the coffee preparation will flash on the display for a few seconds. Then the current time will be displayed.
2. Press the **AROMA**  button to select the desired coffee intensity in **AUTO START** mode. If necessary, depending on the quantity to be dispensed in **AUTO START** mode, press the **4 CUPS**  function button to store the function.
3. The appliance will remain in **AUTO START** mode until the programmed time. The brewing cycle starts automatically.
4. Press the **AUTO START**  button at any time to exit the **AUTO START** mode: the appliance will beep and return to **CLOCK** mode.



4 Cleaning and maintenance

4.1 Warnings



Misuse
Risk of electric shock

- Unplug the drip coffee maker before cleaning.
- Do not immerse the drip coffee maker in water or other liquids.
- Allow the drip coffee maker to cool before cleaning.



Misuse
Risk of damage to surfaces

- Do not use steam jets to clean the drip coffee maker.
- Do not use cleaning products containing chlorine, ammonia or bleach on parts with metallic surface finishes (e.g. anodizing, nickel or chrome plating).
- Do not use abrasive or corrosive detergents (e.g. powders, stain removers and metal scouring pads).
- Do not use rough or abrasive materials or sharp metal scrapers.

4.2 Cleaning the drip coffee maker

To maintain the outer surfaces, you must clean them regularly after each use after letting them cool down. Clean with a soft, damp cloth.

4.3 Cleaning the parts of the drip coffee maker

Cleaning the permanent filter and the filter holder

1. Lift the lid flap (1) and pull up on the permanent filter (2) and then the filter holder (3).

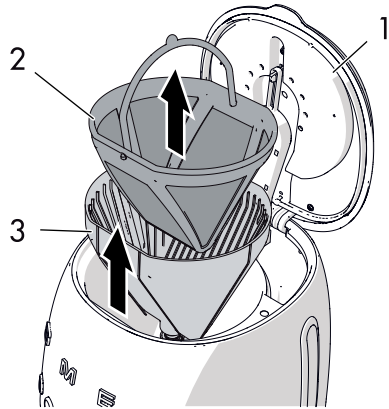

2. Clean the permanent filter and the filter holder by removing any coffee residue.
3. Rinse the filter and filter holder under the faucet and dry thoroughly.



The permanent filter and the filter holder may be washed in the dishwasher.



Cleaning and maintenance

Cleaning the carafe

1. Empty the carafe after each use to avoid stains caused by coffee residues.
2. Wash the carafe in hot, soapy water with a soft brush.
3. Rinse and dry thoroughly.



Risk of damage to the carafe







- Do not wash the carafe in the dishwasher to avoid damaging it permanently.

4.4 Descaling

Depending on the set water hardness, the appliance automatically signals when it is necessary to descale.

The **DESCALING**  icon starts flashing on the display to warn the user that the appliance needs to be descaled.

To activate the descaling cycle:

1. Pour water and descaler into the water tank.
2. Press the **ON/OFF**  and **AUTO START**  buttons simultaneously for 5 seconds to activate the **DESCALING** mode: the LEDs of the **ON/OFF**  and **AUTO START**  buttons flash and the **DESCALING**  icon flashes until the end of the cycle.
3. At the end of the cycle, the display returns to **CLOCK** mode and the **DESCALING**  icon disappears from the display.



4. Rinse the appliance by running it with only water for at least 2 times, filling the tank up to the maximum limit (1.4 liters).



Warning

- Coffee may be brewed even in the presence of a **DESCALING** alarm.
- Carry out the clean cycle when signaled by the appliance.
- **Calcium deposits can compromise the proper functioning of the appliance, especially if the water being used is particularly hard.**



- Proper descaling to remove mineral deposits ensures the aroma of the coffee is maintained and the appliance will function properly in the long term.



Danger of chemical burns and damage to the appliance

- The cleaning solution used to remove mineral deposits contains acids that may irritate the skin or eyes.
- Carefully follow the manufacturer's instructions and the safety warnings listed on the container should the solution come into contact with the skin or eyes.
- Use the cleaning solution recommended by Smeg to ensure your drip coffee maker is not damaged in the process.



Any other servicing should be performed by an authorized service representative.



Cleaning and maintenance

4.5 What to do if...

Problem	Possible cause	Solution
The coffee does not come out	No water in the tank.	Fill the tank.
	Presence of limescale.	Run the descaling cycle.
Coffee takes a long time to come out	Presence of limescale.	Run the descaling cycle.
The coffee has an acidic taste	Possible stagnation of coffee in the circuits.	Rinse as described in paragraph "4.4 Descaling".
The drip coffee maker overflows	The filter is not positioned correctly.	Insert the filter correctly into the filter holder.
	The carafe is not positioned correctly on the base.	Check that the carafe is positioned correctly under the grouphead.
	The lid is not inserted on the carafe.	Insert the lid on the carafe.
	Excessive amount of coffee.	Add to the permanent filter up to a maximum of 5 level scoops of ground coffee.
	Coffee ground too fine.	Use ground coffee for drip coffee makers.

Cleaning and maintenance



Problem

Possible cause

Solution

Only water comes out of the drip coffee maker

No ground coffee in the filter.

Add the desired quantity of coffee to the filter.



If the problem has not been resolved or there are other types of faults, contact your local authorized service center.

23