

Haier

User Manual Dishwasher

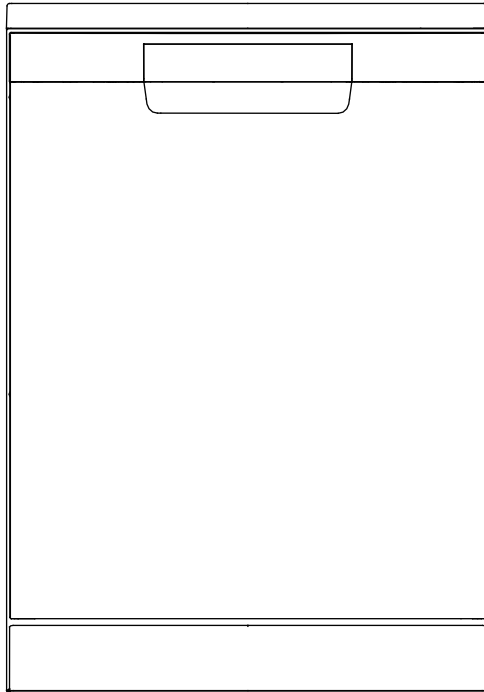

HDWI3VI Models

Thank you for purchasing a Haier product

Please read these instructions carefully before using this appliance. The instructions contain important information which will help you get the best out of the appliance and ensure safe and proper installation, use and maintenance.

Keep this manual in a convenient place so you can always refer to it for the safe and proper use of the appliance.

If you sell the appliance, give it away, or leave it behind when you move house, make sure you also pass on this manual so that the new owner can become familiar with the appliance and safety warnings.

Legend



General information and tips



Warning – Important Safety information



Environmental information

Disposal



Help protect the environment and human health. Put the packaging in applicable containers to recycle it. Help to recycle waste of electrical and electronic appliances. Do not dispose appliances marked with this symbol with the household waste. Return the product to your local recycling facility or contact your municipal office.



WARNING!

Risk of injury or suffocation!

Disconnect the appliance from the mains supply. Cut off the mains cable and dispose of it. Remove the door catch to prevent children and pets to get closed in the appliance.

Content

| | |
|---|-----------|
| Safety | 3 |
| Product Description | 5 |
| Control Panel | 6 |
| Programmes | 8 |
| Before first Use | 9 |
| Daily Use | 12 |
| Care and Cleaning | 20 |
| Troubleshooting | 22 |
| Economic and Environmental Use | 25 |
| Installation | 26 |
| Technical Data | 30 |
| Customer Service | 31 |
| Standards Test | 32 |

Safety

Intended Use

The appliance is designed for domestic use inside the house. It is not intended for commercial or industrial use. Do not use it for purposes other than that for which it was designed.

Changes or modifications to the device are not allowed. Unintended use may cause hazards and loss of warranty claims.

Standards and Directives

This product meets the requirements of all applicable EC directives with the corresponding harmonised standards, which provide for CE marking.

Before Switching on the Appliance for the First Time

Do...

- ▶ make sure all packaging is removed and is kept out of children's reach.
- ▶ make sure that the electrical information on the rating plate agrees with the power supply. If it does not, contact an electrician.
- ▶ use a separate earthed socket for the power supply. The appliance must be earthed.
- ▶ make sure the plug is easy accessible.
- ▶ make sure only the delivered electric cable and hose set are used.
- ▶ hold the plug and not the electric cable when unplugging the power supply.
- ▶ make sure not to damage the electric cable and the plug. If damaged, have it replaced by an electrician.
- ▶ make sure the hose joints and connections are firm and there is no leakage.

Do not...

- ✗ install or use the appliance where the temperature is below 5 °C.
- ✗ use multi-plug adapters and extension cables.
- ✗ let persons, children included, with reduced physical sensory, reduced mental functions or lack of experience and knowledge use the appliance if not supervised by a person responsible for their safety.
- ✗ put flammable products or items that are wet with flammable products in, near, or on the appliance.

During Daily Use

Do...

- ▶ supervise children to prevent them playing with the appliance.
- ▶ put sharp pointed objects (e.g. knives) in a way that there is no danger of injury.

Do not...

- × open the door while a programme operates. The appliance can release hot steam.
- × keep the appliance door open without supervision to prevent tripping and falling.
- × let children or pets come close to the appliance when the door is open.
- × sit or place heavy items on the open door.
- × remove the dishes from the appliance until the programme is completed. There can still be detergent on the dishes.
- × drink the water in the appliance. The water may be contaminated with detergent residues.
- × cover any ventilation openings in the base by a carpet or similar object.
- × use water spray or steam to clean the appliance.
- × let the children make the cleaning and user maintenance without supervision.

WARNING:

Some dishwasher detergents are strongly alkaline. They can be extremely dangerous if swallowed. Avoid contact with the skin and eyes and keep children away from the dishwasher when the door is open. Check that the detergent receptacle is empty after completion of the wash cycle.

Product Description

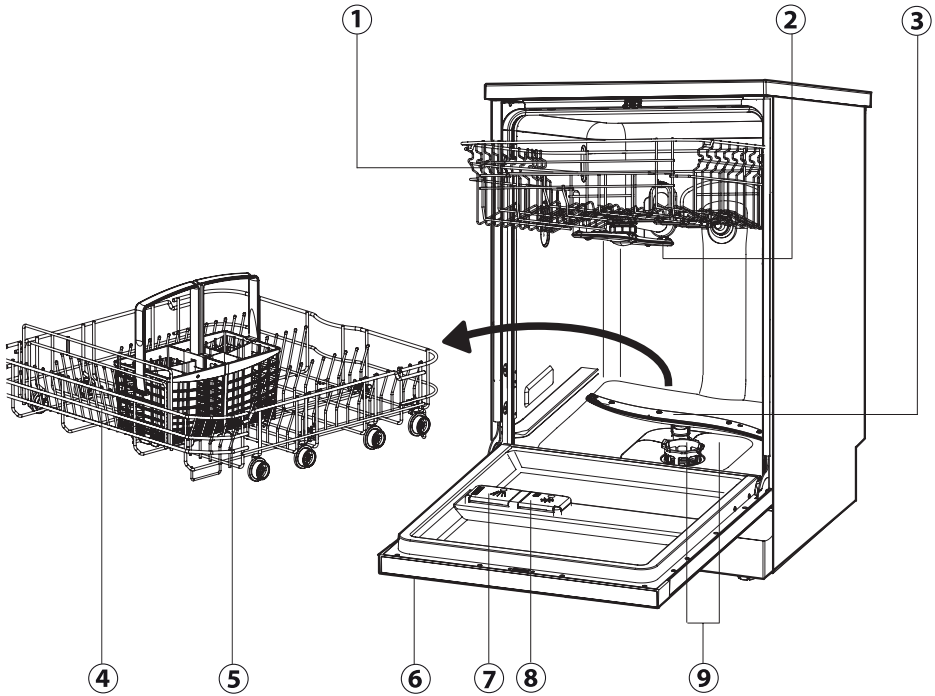

1. Upper basket
2. Upper spray arm
3. Lower spray arm
4. Lower basket
5. Cutlery basket
6. Rating label
7. Detergent dispenser
8. Rinse aid dispenser
9. Filters

Accessories

Check the accessories and literature in accordance with this list:



water inlet hose



U-support



User manual

HDWI3VIWI/SI :

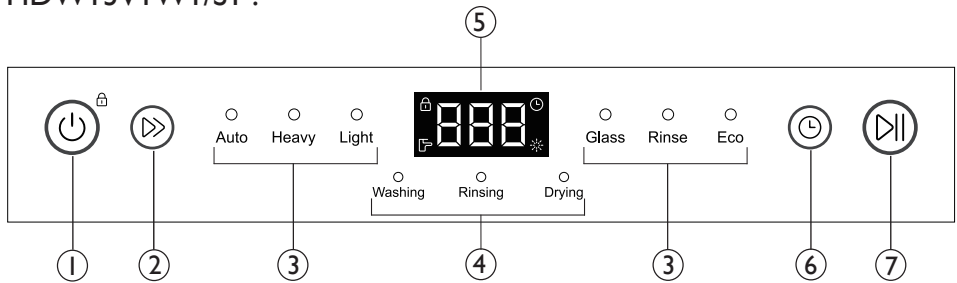

1. ON / OFF button
2. PROGRAMME SELECT button
3. Programme Indicators
4. Status Indication
5. Time & Info Display/Indicator Icon
6. START DELAY button
7. START / PAUSE button

Time & Info display

During any selection the display shows by flashing related information like

- ▶ Programme cycle time
- ▶ Programme start delay time
- ▶ Error codes and service information

After start of an operation it displays without flashing:

- ▶ Remaining time in hours of a delayed programme starts, e.g. 24h
- ▶ Remaining programme cycle time in hours + minutes, e.g. 1:59

While running it may vary due to local conditions and daily working load.

Control Panel

Indicator Icon



Rinse aid

If the indicator lights up: Rinse aid is empty!
After adding Rinse Aid, press  for 3 seconds and the light goes out.



Water tap

If the indicator lights up: The appliance does not fill with water.
Check section: "TROUBLESHOOTING"



Child Lock

If the indicator lights up: Child lock mode has been opened

Delay start

If the indicator lights up: Delay start mode has been opened

Status Indicators



Wash

If the indicator lights up: the Dishwasher is washing.



Rinse

If the indicator lights up: the Dishwasher is rinse washing.



Dry

If the indicator lights up: the Dishwasher is drying.

Option Indication



Delay start

You can delay the start of a programme in 1 hour steps up to 24 hours. Check the according paragraph under "Daily use".



Child Lock

To activate or cancel Child lock, press and hold  until the Child lock indicator comes on or turn off.

Programmes

| Programme | Type of food residue | Type of load |
|---------------------|---|--|
| Auto ¹⁾ | Light to heavy soil: Casseroles, sauces, potatoes, pasta, rice, roasted or fried food | Non-delicate: Dinnerware, cutlery, pots and pans |
| Heavy | Heavy soil: Casseroles, sauces, potatoes, pasta, rice, roasted or fried food | Non-delicate: Dinnerware, cutlery, pots and pans |
| Light ²⁾ | Fresh soil: Coffee, cake, milk, cold drinks, salad, sausages | Non-delicate: Dinnerware, cutlery, glassware |
| Glass | Light soil: Coffee, cake, milk, cold drinks, salad, sausages | Delicate: Glassware, dinnerware, cutlery |
| Rinse ³⁾ | Dishes to be stored for a few days before washing | All: Dinnerware, cutlery, glassware, pots and pans |
| ECO | Normal soil: Soups, eggs, sauces, potatoes, pasta, rice, roasted or fried food | Non-delicate: Dinnerware cutlery, glassware |

- 1) The appliance senses the type of soil and the quantity of items in the baskets. It automatically adjusts the temperature and quantity of water, energy consumption and programme duration.
- 2) With this programme you can wash a load with fresh soil. It gives good washing results in a short time.
- 3) Use this programme to quickly rinse the dishes. This prevents the remaining food to bond on the dishes and bad odours to come out from the appliance. Do not use detergent with this programme!

Before first Use

First Steps

Remove all packaging materials, keep them out of children's reach and dispose them in an environmentally friendly manner. There could be water residue inside the appliance due to quality checks in the factory.

Perform the following steps:

1. Install the appliance.
 - ▶ Refer to section INSTALLATION.
2. Only for use of Multitabs: Adjust the rinse aid setting.
 - ▶ Refer to section DIFFERENT SETTINGS FOR RINSE AID.
3. Fill the rinse aid dispenser.
 - ▶ Refer to section HOW TO FILL THE RINSE AID DISPENSER.
4. Open the water tap.
5. Start any wash programme (apart from Rinse programme) with detergent but no load to remove possible manufacturing residues.

Activate / De-Activate the Buzzer

An acoustic signal informs about the end of a programme. This signal can be switched off.

Refer to section HOW TO ADJUST SETTINGS and select the *b*-setting:

- ▶ If the display shows *b 0* the signal is switched off.
- ▶ If the display shows *b 1* the signal is switched on.

Different Settings for Rinse Aid

Rinse aid is added during the last rinsing phase to dry the dishes without streaks and stains.

Detergent (e.g. powder, tablets, ...)

- ▶ requires separate rinse aid:
Factory default setting: $d5$. No settings are necessary.
The rinse aid is added from the rinse aid dispenser only.

Detergent with multifunction (e.g. Multitabs)

- ▶ combine detergent and rinse aid:
The rinse aid setting should be adjust to $d2$. Please use the setting instructions in section HOW TO ADJUST SETTINGS and select the d -setting.
The rinse aid is added from the rinse aid dispenser in addition to the multitabs rinse aid.

Setting d - cuts off the rinse aid dosage and the rinse aid indication.
The higher the value for d the higher the dosage.

Usually the recommended setting performs well. In case of streaks, stains, shimmer etc.; refer to section TROUBLESHOOTING.

How to fill the Rinse Aid Dispenser



CAUTION!

Only use rinse aid for dishwashers.
Other products can cause damage to the appliance!

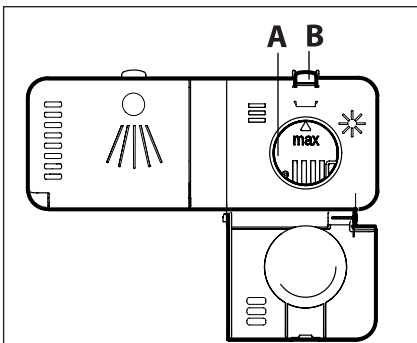

1. Press the release button (**B**) to open the lid.
2. Fill the tank (**A**) up to the 'max' mark.
3. Remove any spilled rinse aid with an absorbent cloth. Overdosed or spilled rinse aid may cause problems creating foam
4. Close the lid. Make sure that the release button locks into position.



Before first Use

How to Adjust Settings





To adjust the Rinse Aid level

1. The appliance is switched off.
2. Press and hold  about 3 seconds until:
 - ▶ The display shows the current Rinse Aid setting (the default is *d5*).





3. Press  to change the Rinse Aid setting in steps between *d-* (minimum dispense) and *d5* (maximum dispense).
4. To exit the Rinse Aid menu, press and hold  for 1 second.

Activate / De-Activate the Buzzer



1. The appliance is switched off.
2. Press and hold  for about 3 seconds until:
 - ▶ The display shows the current Rinse Aid setting.
3. Press  to scroll to the buzzer menu.
4. The display will show *b0* (buzzer off) or *b1* (buzzer on).
5. Press  to toggle between *b0* (buzzer off) or *b1* (buzzer on).
6. To exit, press and hold  1 second.

Child lock

This feature disables all the buttons on the dishwasher. If any other buttons are pressed while Child lock is activated, the Child lock indicator will flash for a few seconds.

1. To activate Child lock, press and hold  for 3 seconds.
2. The display will remain on (if no programme has been started it will continue to flash while the control panel is locked).
3. To cancel Child lock, press and hold  for 3 seconds.

Please note that not all sales models comes with identical features and options. So pictures of that chapter are sometimes different to your dishwasher model. Explanations try only to point out basic model variants.

1. Load the baskets.
2. Press the ON/OFF button  to activate the appliance.
 - ▶ If the rinse aid indicator is on, fill the rinse aid dispenser and reset the rinse aid indicator; refer to section HOW TO RESET THE RINSE AID IDNICATOR.
3. Add the detergent; refer to section DETERGENT.
4. Close the door.
5. Set the programme according to the type of load and how dirty the dishes, cups and cutlery are.
6. Maybe select a start delay time.
7. Press the START / PAUSE button  to start the programme.
8. After programme end the appliance change to auto off. Unload the baskets.

How to Reset Rinse Aid Indicator

The appliance is switched on.

The rinse aid indicator is on:

1. Always completely fill the rinse aid before starting the next wash cycle.
2. Press and hold the START/PAUSE button  until the Rinse Aid indicators light up. The Status Indicators light up.

Daily Use

Load the Baskets

i With delicate glasses and porcelain make sure they are labelled dishwasher-proof.

- ✘ Do not put in the appliance items made of wood, horn, aluminium, pewter and copper.
- ✘ Do not put in the appliance items that can absorb water (sponges, household cloths).
 - ▶ Only use the appliance to wash items that are dishwasher-safe.
 - ▶ Remove remaining food from the items.
 - ▶ Soften burned food on the items before washing.
 - ▶ Put hollow items (cups, glasses and pans) with the opening down.
 - ▶ Put items with deep hollows in a slanted position.
 - ▶ Mix spoons with other cutlery to prevent them to bond together.
 - ▶ Make sure that cutlery and dishes do not bond together and there is a gap between each item.
 - ▶ Make sure that glasses do not touch other glasses.
 - ▶ Put small items in the cutlery basket.
 - ▶ Put light items in the upper basket. Make sure that the items do not move.
 - ▶ Make sure that the spray arms can move freely before you start a programme.

i If jingling noises are heard during a programme run: Check that the dishes and glassware have a firm position.

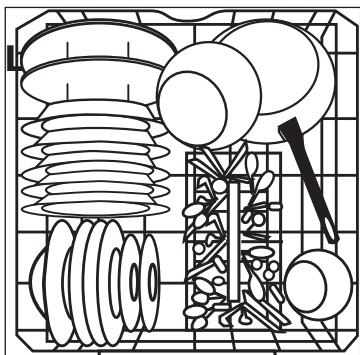

Place heavily soiled items (like pots and pans or dinner plates) in the bottom basket. The more powerful spray jet provides a better dishwashing result.

Upper basket

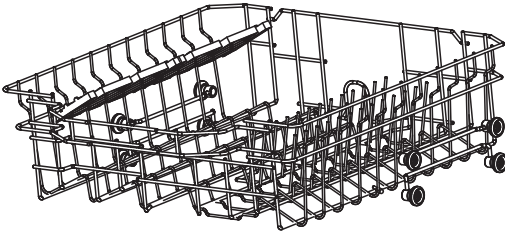

- ▶ The upper basket is designed to hold items like glasses, cups, saucers, plates, small bowls and shallow pans.
- ▶ You can adjust the height of the upper basket to create more space for tall items in the lower basket. See below.
- ▶ Place small items on the foldable cup holder.

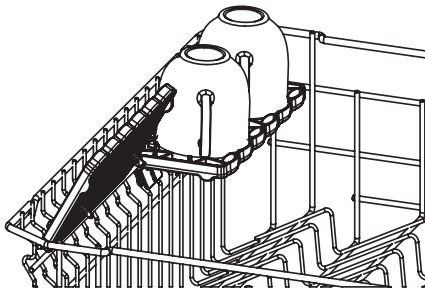

IMPORTANT!

Place sharp and pointed items with the blade pointing downward into the knife rack, to keep them out of harms way.

Adjusting the height of the upper basket

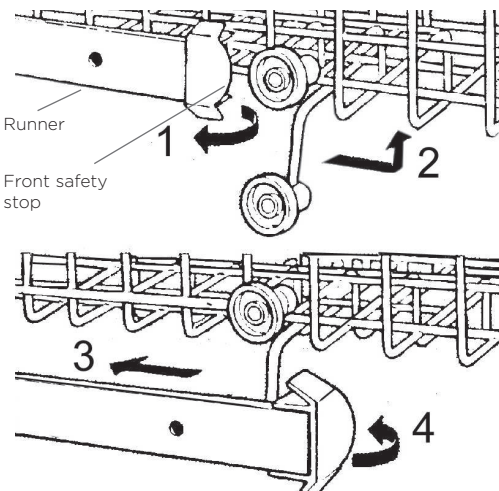

IMPORTANT!

Before you adjust its height, make sure the basket is empty.

- ① Turn the front safety stops on either side outwards.
- ② Slide the empty basket out of the runners.
- ③ Reinsert the higher or lower set of rollers in the runners and slide the basket all the way back in.
- ④ Turn the front safety stops inwards.

Daily Use

Lower basket



- ▶ Place the largest items here: pots, pans, lids, serving dishes and bowls.
- ▶ Fold down the tines to place pots and pans flat on the bottom.
- ▶ Ensure dishware items do not block the spray arm above from rotating.
- ▶ If you need more height for tall items, you can raise the upper basket. See instructions on previous pages.

Cutlery basket

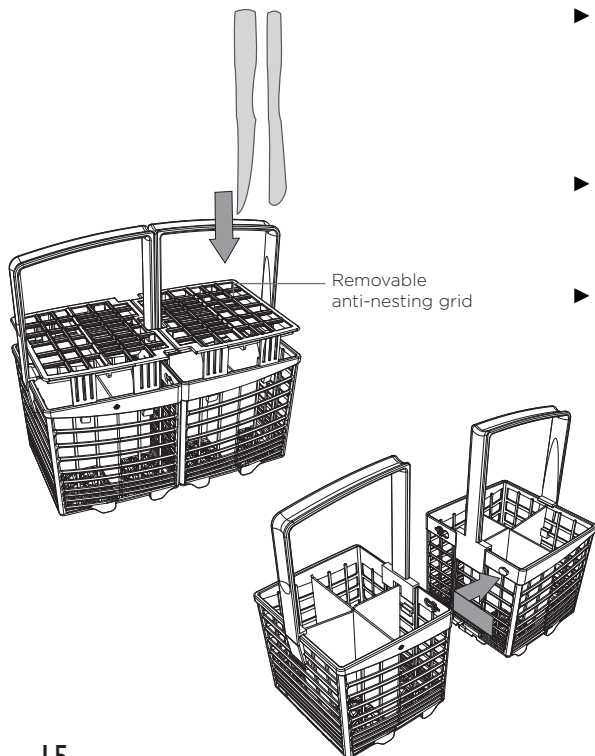

- ▶ To reduce the risk of injury, we recommend loading knives and sharp utensils with handles facing up.
- ▶ Mix spoons, knives and forks within each section to stop cutlery nesting together and to ensure the water circulates freely. Alternatively, use the clip-on anti-nesting grids to keep cutlery items apart. Keep stainless steel from touching silver cutlery to avoid staining.
- ▶ You can halve the cutlery basket as shown and use just one section. This is useful if the cutlery load is light or if you want to make more space for other dishes.

Detergent



Please use only a dedicated dishwasher detergent and follow the related instructions and dosage on its package.

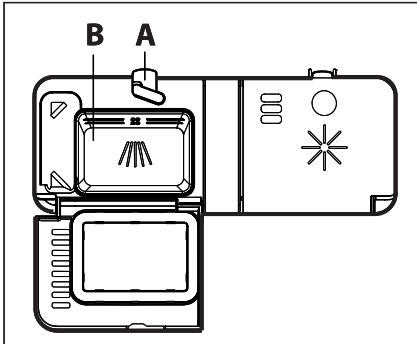

1. If the lid is closed press the release button **(A)** to open the lid.
2. Put any detergent into compartment **(B)**.
3. If the programme has a pre-wash phase, put a small quantity of detergent on the inner part of the appliance door. Refer to section PROGRAMMES.
4. Close the lid. Make sure that the release button locks into position.

Multitabs

These Multitabs detergent tablets could include two different agents for water softening, rinse aid and other functions. The softener and rinse aid setting must be adjusted according to section BEFORE FIRST USE.

Usually the default setting performs well. If there are streaks, stains, shimmer etc.; refer to section TROUBLESHOOTING and BEFORE FIRST USE.





Detergent tablets do not fully dissolve with short programmes. That may cause bad washing results and detergent residues.

If detergent without multifunction should be used again:

1. Save 3 to 5 tablets
2. Adjust the softener and rinse aid setting according to section BEFORE FIRST USE.
3. Use Multitabs detergent tablets for the next 3 to 5 wash cycles.

Daily Use

Start a Programme



1. Close the door.
2. Press the ON/OFF button .
3. Press the program button you want to select and then the required programme indicator lights up.
Additionally the display flashes the programme run-time.
4. If desired select a start time for a delay start. Refer to section START A PROGRAMME WITH DELAY.
5. Press the START/PAUSE button  to activate the programme or the delay start.
The programme starts. The display acts now as countdown of the remaining run-time.



The appliance remembers the last programme you used. The next time the appliance will switch on, the appliance pre-selects the programme last used.

Interrupt a Running Programme

To interrupt a programme run:

- ▶ Press the START/PAUSE button . In the display  is flashing.
and/or
- ▶ Open the door. The displayed cycle time is flashing.

Press the START/PAUSE button  and/or close the door to continue the programme from the point of interruption. Longer breaks may cause bad cleaning results.

Activate / Deactivate options

On some models, the combination of all options is possible with all programmes. You can set one option or combine all options.

1. Switch on the appliance.
2. Press any of the currently extinguished washing procedure icons to select the washing procedure.
The display shows the duration of the programme.
3. If needed, press any unlit additional function button (1/2, wash block, increase the brightness).
If it can be matched with the current washing procedure,

the additional function indicates that the icon will be lit, and if it cannot be matched, it will not be lit.

4. If the currently selected washing procedure is rapid washing, washing and single rinsing, press the \oplus and add the button, the washing time can be increased by 10 minutes at a time, up to three times.
5. Press the button $\triangleright||$ to start the program.

Start a Programme with Delay

Set a start time by the following procedure in order to delay a programme start:

1. Set a programme.
2. Press and hold the reservation button \textcircled{L} until the display flashes the required delay time (from 1 to 24hours).
3. Press the START/PAUSE button $\triangleright||$.
 - ▶ The display shows the countdown of the start delay. The countdown decreases with steps of 1 hour.
4.
 - ▶ When the countdown is completed, the programme starts.

Cancel a Delayed Start

When the current reservation time is displayed for 24h, press the reservation \textcircled{L} button again to cancel the reservation. Afterwards the display flashes with the duration time for the set programme.

The selected programme starts after a few seconds

Daily Use

Cancel Start Delay / Programme

1. Press the ON/OFF button  for about 1 second.
 - ▶ The start delay is cancelled.
 - ▶ The programme is aborted.
 - ▶ The appliance is switched off.
2. Start a new programme and a delayed start if desired.



CAUTION!

If a programme will be aborted in the process of washing dishes, the residue of detergent remains on the dishes. These can cause damage to health! Make sure to rinse off the detergent residues completely before using these dishes again.



Make sure that there is detergent in the detergent dispenser before start a new programme.

End of Programme

When the programme is completed, the display shows  and an acoustic signal is heard (if it is not switched off). The display switches off.

1. Press  to switch off the appliance or the appliance switches into standby mode automatically after 2 minutes.
2. Open the door.



CAUTION!

If the door will be opened immediately after the end of programme, hot steam can escape. Danger of scalding! Open the door carefully!

3. Remove dishes:
 - ▶ Open the door slightly and leave it ajar (about 100 mm) to help the drying process.
 - ▶ Let the dishes become cold before removing them from the appliance. Hot dishes damage more easily.
 - ▶ First remove the items from the lower basket, then from the upper basket.



There can be water on the sides and on the door of the appliance. Stainless steel becomes cool more quickly than the dishes.

Standby Mode

The switched on appliance will go into standby mode if it is not activated within 2 minutes before starting a programme, or at the end of a programme. This saves energy. The display switches off. To interrupt the standby mode push one button.

Care and Cleaning

Inspect and clean your appliance at regular intervals. Basically any detergent and food residues may cause diverse problems. But especially dirty filters, clogged or blocked spray arms significantly decrease the washing results.

Care and Cleaning the Filters

There are three filters (A1, A2, B) to be checked and cleaned.

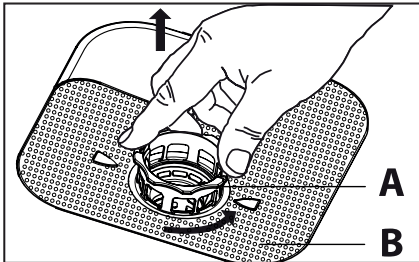

1. Turn the filter **A** anticlockwise and remove it.

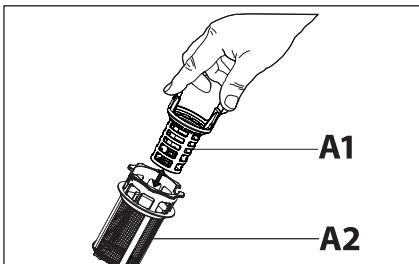

2. To disassemble the filter **A** press the latches and unplug **A1** from **A2**.

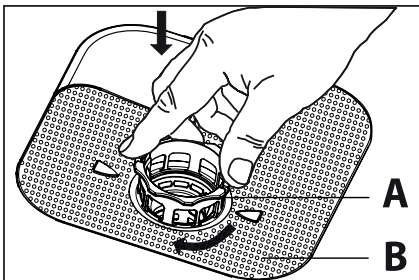

3. Remove the filter **B**.
4. Clean the filters with water.
5. Put the filter **B** to its initial position.
6. Assemble the filter **A** and put it into position in filter **B**. Turn it clockwise until it locks.



An incorrect assembly or position of the filters will cause bad washing results and possibly serious damage to the appliance.

If any filter is removed make sure that no solid object of any size is left beyond these filters!

Care and Cleaning

Care and Cleaning of the Spray Arms

Spray arms should be regularly inspected for dirt. If needed the spray arms could be removed.

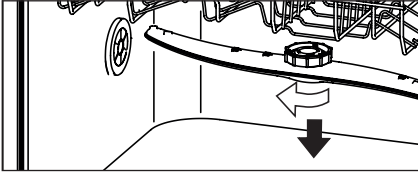

Upper spray arm

1. Turn bayonet socket to the left to remove spray arm.
2. Remove remaining parts of food remnants with a thin pointed object.
3. Flush with water and check all the holes are clear.
4. Turn bayonet socket clockwise to fasten spray arm.

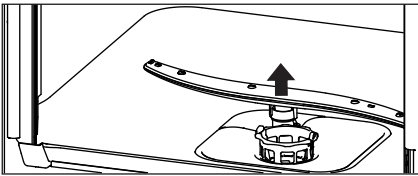

Lower spray arm

1. Pull at the center to remove spray arm.
2. Remove remaining parts of food remnants with a thin pointed object.
3. Flush with water and check all the holes are clear.
4. Place spray arm at the center with a light push.

External Cleaning



CAUTION!

Never clean the appliance with a steam cleaner.
Never use bleach or other chlorinated detergents.

- ▶ Clean the appliance with a damp soft cloth.
- ▶ Only use neutral detergents. Do not use abrasive products, abrasive cleaning pads or solvents.
- ▶ Clean the door seal with a damp soft cloth.

Troubleshooting

Many occurring problems could be solved by yourself without specific expertise. In case of a problem please check all shown possibilities and follow below instructions before you contact an after sales service



CAUTION!

- ▶ Before maintenance, deactivate the appliance and disconnect the mains plug from the mains socket.
- ▶ Electrical equipment should be serviced only by qualified electrical experts, because improper repairs can cause considerable consequential damages.

The appliance does not start, or it stops during operation

| Problem | Possible cause | Possible solution |
|--|--|--|
| The programme does not start. | Appliance door is open. | Close the appliance door. |
| | Delay start is set. | Refer to displayed time. |
| | Mains plug is not connected in the mains socket. | Connect the mains plug. |
| | Fuse in the house circuit is damaged. | Replace the fuse. |
| Rinse Aid Indicator  is lighted. | Rinse aid dispenser is empty. | Refill Rinse aid until full |
| | Refill of rinse aid was not confirmed. | Press and hold the START/PAUSE button for 3 sec after each refill. |

Troubleshooting

Error codes on the display

| Problem | Possible cause | Possible solution |
|---|---|---|
| Acoustic alarm, display shows ALARMCODE <i>A10</i> The appliance does not fill with water. | Water tap is closed. | <ul style="list-style-type: none"> • Open the water tap. Note: Whenever Error 'A10' is solved switch off the appliance and restart the programm. |
| | Water inlet hose has a kink or a bend. | Make sure that the position of the hose is correct. |
| | In case of aqua-stop system: water protection is triggered; the marker (C) is red. | The hose must be replaced. |
| | Filter in the water inlet hose is clogged. | Clean the filter at the inlet hose connections at tap and the rear of the appliance. |
| | Water inlet is clogged. | Check water flow from tap. |
| | Water pressure is too low. | Contact your local water authority. |
| Acoustic alarm, display shows ALARMCODE <i>A20</i> The appliance does not drain sufficiently. | Filters are clogged. | <ul style="list-style-type: none"> • Scoop out as much water as possible. • Clean filters. • Continue programme by pressing the START/PAUSE button. |
| | The drainage is blocked. | <ul style="list-style-type: none"> • Scoop out as much water as possible. • Make sure that drain water-connection and piping is correct and not blocked. • Continue programme by pressing the START/PAUSE button. • If the fault persists, contact customer care. |
| Acoustic alarm, display shows ALARMCODE <i>F30</i> Leak: The drain pump runs permanently! | Anti-flood device is on: <ul style="list-style-type: none"> • There are water leakages in the appliance. • The water inlet valve is open and blocked. • The drainage is blocked. | <ol style="list-style-type: none"> 1 Close the water tap. 2 Disconnect appliance from power supply. 3 Contact Service. |

All other Alarmcodes:

1. Note Alarmcode
2. Contact Service ; refer to CUSTOMER SERVICE

Troubleshooting

Washing Results are not satisfactory

| Problem | Possible cause | Possible solution |
|---|--|---|
| The dishes are not clean. | Filters are clogged. | Clean the filters. |
| | Filters are not correctly assembled and installed. | Make sure that the filters are correctly assembled and installed. |
| | Spray arms are clogged. | Remove remaining food remnants with a thin pointed object. |
| | Programme was not applicable for the type of load and food remnants. | Make sure that the programme is applicable for the type of load and food remnants. |
| | Incorrect position of the items in the baskets. Water could not wash all items. | Make sure that the position of the items in the baskets is correct and that the water can easily wash all items. |
| | Spray arms could not turn freely. | Make sure that the position of the items in the baskets is correct and does not cause the blockage of the spray arms. |
| | No detergent or insufficient quantity of detergent in the detergent dispenser. | Make sure that you add the correct quantity detergent in the dispenser before you start a programme. |
| | The wash cycle was interrupted by a long break. | Do not open the door or cut power supply during the wash cycle. |
| Whitish streaks, stains or bluish layers on glasses and dishes. | Released quantity of rinse aid is too much. | Decrease the released quantity of rinse aid. Refer to section DIFFERENT SETTINGS FOR RINSE AID. |
| | Quantity of detergent was too much. | Make sure that you add the correct quantity of detergent in the dispenser before you start a programme. |
| | Multitab detergent tablets used with a short programme might not fully dissolve. | Select a longer programme when using Multitab detergent tablets |

Troubleshooting

| Problem | Possible cause | Possible solution |
|--|--|---|
| Dry water drop stains on glasses and dishes. | Rinse aid dosage is too low. | Increase the released quantity of rinse aid. Refer to section DIFFERENT SETTINGS FOR RINSE AID. |
| | Quality of rinse aid or Multitab. | Cleaning product too old; change the product. |
| The dishes are wet. | <ul style="list-style-type: none">• Programme had no drying phase.• Programme had a low temperature drying phase. | Open the door slightly and leave it ajar (about 100 mm) to help the drying process. |
| The dishes are wet and matte. | Rinse aid dispenser is empty. | Refill rinse aid into the dispenser and reset the rinse aid indicator. |
| | Quality of rinse aid or Multitab. | Cleaning product too old; change the product. |



Economic and Environmental Use

- ▶ It is not recommended to pre-rinse the dishes under running water.
- ▶ Select the washing programmes by type and degree of contamination of the dishes.
- ▶ Select the economy mode programme ECO for normal soiled items.
- ▶ The most economically use you will have with full loading.
- ▶ Only use the manufacturer's recommended detergent or rinse aid dosages.



WARNING!

Any installation may be carried out only by a qualified technician; refer to section SAFETY.

Free Standing Installation

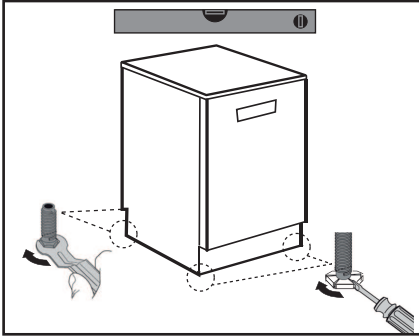

1. Install the appliance on solid ground. Adjust accurately all feet to get a firm, horizontal position.



INFORMATION!

Only with a correct level the appliance door closes and seals correctly.

Installation under Worktop

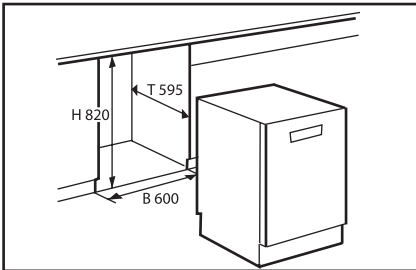

1. The dimensions of the recess should at least agree with the dimensions in the figure.
2. Put the appliance adjacent to the slot. Make sure that all connections (water; drain water; power) are neatly positioned and connected.

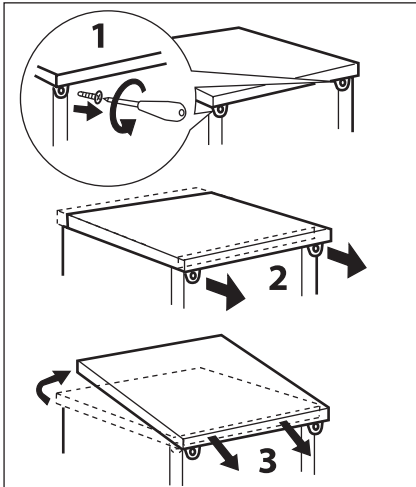

3. **Optional:** Remove the worktop of the appliance.
4. Adjust accurately all feet to get a firm level position.
5. Install the appliance carefully into the recess.



WARNING!

If used as free standing appliance again, the worktop must be remounted.

Installation

Fresh Water Connection

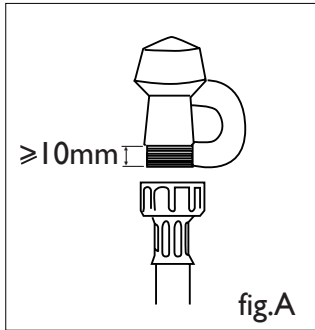

IMPORTANT!

- ▶ The appliance should be connected to the water main using the new water inlet hose supplied. Old hoses should not be used.
- ▶ Do not shorten the inlet hose.

1. Take note of water connection requirements.
 - ▶ The dishwasher has a single valve water connection.
 - ▶ We recommend a cold water connection for best performance and energy efficiency.
 - ▶ The incoming water temperature should not exceed 25°C.
2. Take note of the permitted water pressure extremes.
 - ▶ Lowest: 0.3 bar = 3 N/cm² = 30kPa
 - ▶ Where pressure is below 1 bar, contact a qualified plumber.
 - ▶ Highest: 10 bar = 100 N/cm² = 1MPa
 - ▶ Where pressure is above 10 bar, a pressure reduction valve must be installed. Contact a qualified plumber.
3. Connect the water inlet hose to an accessible water tap with a 3/4" BSP connector (see fig.A). Ensure that there is no kink in the inlet hose that could restrict the flow of water. A 90° bend requires a minimum height of 200 mm for a kink-free curve.
 - ▶ Ensure incoming water is clear. If the water pipes have not been used for a long period of time, let the water run to make sure it is clear with no impurities. Not doing so may result in the water inlet hose getting blocked and damaging the appliance.
 - ▶ If required, use a filter insert to filter out deposits from the piping. The filter insert is available from your Authorised Service Centre or Customer Care.
4. Tighten the hose coupling a further half turn after seal contact.
5. Check that the connection does not leak.

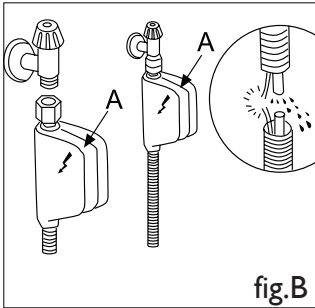

- ▶ Some models are fitted with an “Aquastop” water supply hose (see fig.B) in which the small filter is already housed in the threaded end.

Anti-Flooding protection

The dishwasher is equipped with a system that stops the supply of water in the event of a problem with the water supply hose, or leaks within the unit, in order to prevent damage to your home. If for any reason the box containing the electrical components happens to get damaged, turn off the power supply and remove the plug for the appliance from the socket immediately. In order to guarantee that the anti-flooding feature operates properly, the “A” box with water supply hose must be attached to the water supply tap as shown in fig.B. No other type of connection is acceptable. The water supply hose must not, under any circumstances, be cut, as it contains electrical parts which are live. If the length of the hose is not adequate to make a proper connection, the hose must be replaced with one which is long enough. This hose is available upon request from specialised retailers and Authorised Service Center.

Installation

Drain Water Connection

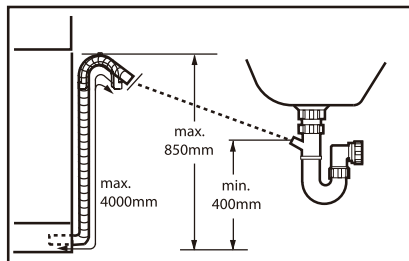

Fix the water drain hose properly to the piping. The hose has to reach at one point a height between 400 and 850 mm above the appliance bottom line!

An extension hose for the water drain hose must not exceed a total length of 4 m and must have the same diameter as the water drain hose.

Following connections are possible:

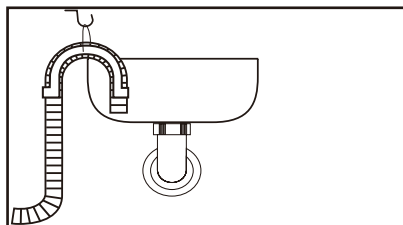

Drain hose to sink

- ▶ Hang the drain hose with the U-support over the edge of a sink with adequate size.
- ▶ Protect the U-support sufficiently against slipping.

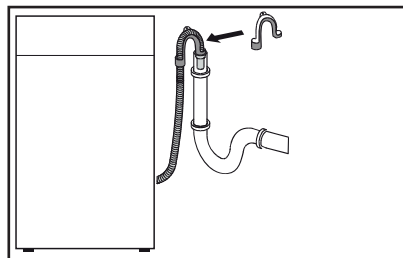

Drain hose to waste water connection

- ▶ The internal diameter of the stand pipe with vent-hole must be minimum 40 mm.
- ▶ Put the drain hose for approx. 80 mm in the wastewater pipe.
- ▶ Attach the U-support and secure it sufficiently.

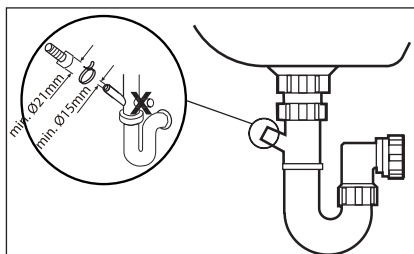

Drain hose to sink connection

- ▶ When connecting the drain hose to a sink trap with a drain hose spigot, make sure that the drain hose is supported to the height of the bench.
- ▶ Ensure the drain spigot has a minimum hole diameter of 15 mm and it has been drilled out.



CAUTION!

Ensure always that all connections (power supply, drain and fresh water hose) are firm, dry and leak free! Take care these parts are never to be crushed, kinked, or twisted. If the supply cord is damaged, it must be replaced by the service agent (see warranty card) in order to avoid a hazard.

Technical Data

Check the electrical data on the rating label (located on the left-hand side of the dishwasher's stainless steel inner door). Should the data on the rating label be different to those specified below, consider those on the rating label as correct.

| | |
|---|---------------------------|
| Suppliers name or trade mark | Haier |
| Supplier's model identifier | HDWI3VI |
| Rated capacity in standard -place settings | 13 |
| Mains water pressure | 0.03-1 MPa (= 0.3-10 bar) |
| Power voltage | 220-240 V (50Hz) |
| Maximum current intensity | 10 A |
| Total absorbed power | 1720-2050 W |
| Colour White Stainless Steel | HDWI3VIWI/HDWI3VISI |

Customer Service

We recommend our Haier Customer Service and the use of original spare parts.

If you have a problem with your appliance, please first check section TROUBLESHOOTING.

If you cannot find a solution there, please contact

- ▶ your local dealer or
- ▶ the Service & Support area at www.haier.com.au
or at www.haier.co.nz
where you can activate the service claim and also find FAQs.

To contact our Service, ensure that you have the following data available. The information can be found on the rating plate at the door.

Model _____

Serial No. _____

| | |
|-----------------------------------|--|
| Wash programme | Eco When the programme is finished, open the door 100mm to help with drying |
| Powdered detergent quantities | 5 g pre-wash + 28.75g main wash |
| Rinse aid dosage level | d5 |
| Maximum number of place settings | 13 |
| Height adjustment of upper basket | Ensure the upper basket is in its upper most position |

Recommended loading patterns

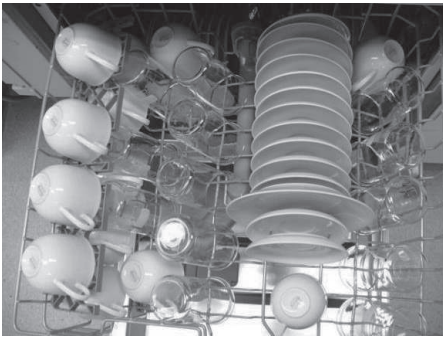

Upper basket

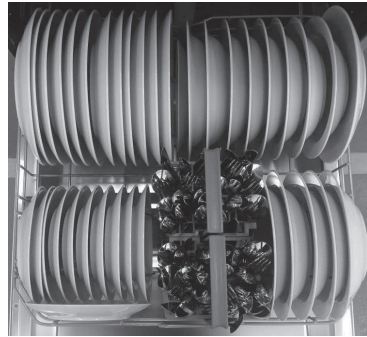

Lower basket

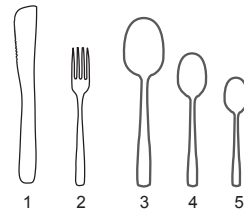
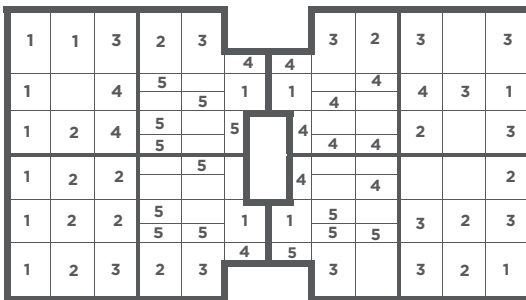

Cutlery basket