

Midea Built-in Electric Oven Instruction

MODEL: MO9BL MO9SS
60cm 9 Function Oven

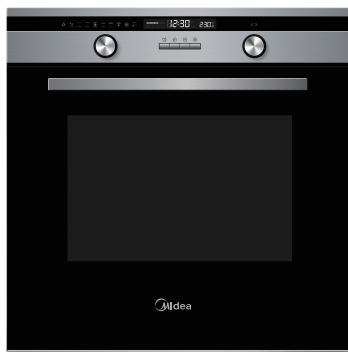

MO9BL



MO9SS



SAVE THESE INSTRUCTIONS CAREFULLY

Read these instructions carefully before using your oven, and keep it carefully. If you follow the instructions, your oven will provide you with many years of good service.

ACKNOWLEDGMENT

Thank you for purchasing our product. We hope you enjoy using the many features and benefits it provides. Before using this product please study this entire Instruction Manual carefully. Keep this manual in a safe place for future reference. Ensure that other people using the product are familiar with these instructions as well.

WARNING

- When the oven is first switched on, it may give off an unpleasant smell. This is due to the bonding agent used for the insulating panels within the oven. Please run up the new empty product with the conventional cooking function, 250°C, 90 minutes to clean oil impurities inside the cavity.
- Please use the oven under the open environment.
- The oven and its accessible parts become hot during use. Care should be taken to avoid touching heating elements. Children less than 8 years old shall be kept away unless continuously supervised.
- If the surface is cracked, switch off the oven to avoid the possibility of electric shock.
- This oven is not intended to be used by persons (including children) with reduced physical, sensory or mental capabilities, or lack of experience and knowledge, unless they have been given supervision or instruction concerning use of the appliance by a person responsible for their safety. Children shall not play with the appliance. Cleaning and user maintenance shall not be made by children without supervision.

- Do not allow children to go near the oven when it is operating, especially when the grill function is on.
- Ensure that the appliance is switched off before replacing the oven lamp to avoid the possibility of electric shock.
- An all-pole disconnection means must be incorporated in the fixed wiring in accordance with the wiring rules.
- If the supply cord is damaged, it must be replaced by the manufacturer, its service agent or similarly qualified persons in order to avoid a hazard.
- Do not use harsh abrasive cleaners or sharp metal scrapers to clean the oven door glass since they can scratch the surface, which may result in shattering of the glass.
- A steam cleaner is not to be used.
- The oven is not intended to be operated by means of an external timer or separate remote-control system.
- The oven must not be installed behind a decorative door in order to avoid overheating.

SAFETY HINTS

- Do not use the oven unless you are wearing something on your feet. Do not touch the oven with wet or damp hands or feet.
- For oven: Oven door should not be opened often during the cooking period.
- The oven must be installed by an authorized technician and put into use. The manufacturer is not responsible for any damage that might be caused by defective placement, and installation by unauthorized personnel.
- When the door of oven is open do not leave anything on it, you may unbalance your oven or break the door.
- Some parts of oven may keep its heat for a long time; it is required to wait until they are cool down before touching on them.
- If you will not use the oven for a long time, it is advised to plug it off.

FITTING THE OVEN INTO THE KITCHEN UNIT

Fit the oven into the space provided in the kitchen unit; it may be fitted underneath a worktop or into an upright cupboard. Fix the oven in position by screwing into place, using the two fixing holes in the frame. To locate the fixing holes, open the oven door and look inside. To allow adequate ventilation, the measurements and distances shall be adhered to when fixing the oven.

IMPORTANT

Ensure that cabinetry can withstand temperatures of at least 120 degrees. Materials that cannot withstand such temperatures may melt and deform the unit.

Once the oven has been positioned inside the cabinet electrical wiring must be completely insulated. This is a legal safety requirement. Ensure sufficient space at the rear of the cabinet to allow an air flow clearance of at least 45mm.

DECLARATION OF COMPLIANCE

When you have unpacked the oven, make sure that it has not been damaged in any way. If you have any doubts at all, do not use it: contact a professionally qualified person. Keep packing materials such as plastic bags, polystyrene, or nails out of the reach of children because these are dangerous to children.



PRODUCT DESCRIPTION - MO9BL

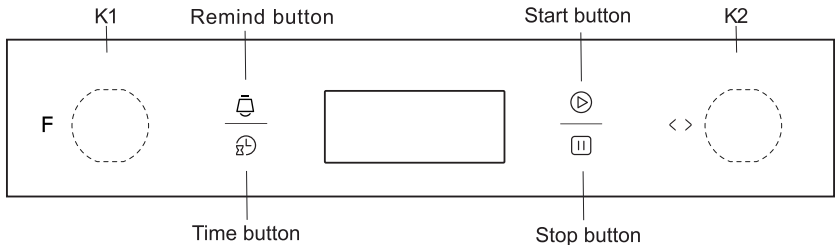

Symbol	Function description
	Oven Lamp: Which enables the user to observe the progress of cooking without opening the door. Oven lamp will light for all cooking functions.
	Defrost: The circulation of air at room temperature enables quicker thawing of frozen food, (without the use of any heat). It's a gentle but quick way to speed up the defrosting time and thawing of ready-made dishes and cream filled produce etc.
	Bottom element : A concealed element in the bottom of the oven provides heat. It is mainly used for keeping food warm. The temperature can be set within the range of 60-120°C. The default temperature is 60°C.
	Conventional cooking: The top and bottom elements work together to provide conventional cooking. The temperature can be set within the range of 50-250°C. The default temperature is 220°C This is optional function that can be work with rotisserie motor.
	Convention with fan: Combination of the fan and both heating element provides more even heat penetration, saving up to 30-40% of energy. Dishes are lightly browned on the outside and still moist on the inside. Note: This function is suitable for grilling or roasting big pieces of meat at a higher temperature. The temperature can be set within the range of 50-250°C. The default temperature is 220°C.
	Radiant grilling: The inner grill element switches on and off to maintain temperature. The temperature can be set within the range of 150-240°C. The default temperature is 210°C. This is optional function that can be work with rotisserie motor.
	Double grilling: The inside radiant element and top element are working together. The temperature can be set within the range of 150-240°C. The default temperature is 210°C. This is optional function that can be work with rotisserie motor.
	Double grilling with fan: The inside radiant element and top element are working with fan The temperature can be set within the range of 150-240°C. The default temperature is 210°C.
	Convection: An element around the convection fan provides an additional source of heat for convection style cooking. In convection mode the fan automatically comes on to improve air circulation within the oven and creates an even heat for cooking. The temperature can be set within the range of 50-240°C. The default temperature is 180°C.

PRODUCT DESCRIPTION - MO9SS

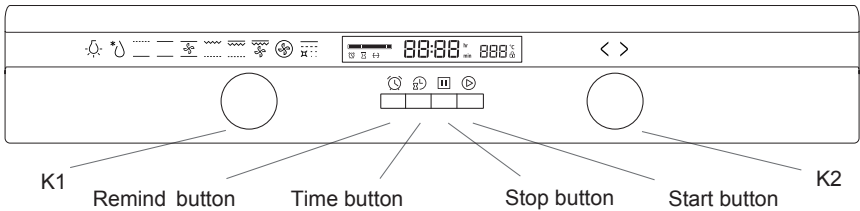



Symbol	Function description
	Oven Lamp: Which enables the user to observe the progress of cooking without opening the door. Oven lamp will light for all cooking functions.
	Defrost: The circulation of air at room temperature enables quicker thawing of frozen food, (without the use of any heat). It's a gentle but quick way to speed up the defrosting time and thawing of ready-made dishes and cream filled produce etc.
	Bottom element : A concealed element in the bottom of the oven provides heat. It is mainly used for keeping food warm. The temperature can be set within the range of 60-120°C. The default temperature is 60°C.
	Conventional cooking: The top and bottom elements work together to provide conventional cooking. The temperature can be set within the range of 50-250°C. The default temperature is 220°C This is optional function that can be work with rotisserie motor.
	Convention with fan: Combination of the fan and both heating element provides more even heat penetration, saving up to 30-40% of energy. Dishes are lightly browned on the outside and still moist on the inside. Note: This function is suitable for grilling or roasting big pieces of meat at a higher temperature. The temperature can be set within the range of 50-250°C. The default temperature is 220°C.
	Radiant grilling: The inner grill element switches on and off to maintain temperature. The temperature can be set within the range of 150-240°C. The default temperature is 210°C. This is optional function that can be work with rotisserie motor.
	Double grilling: The inside radiant element and top element are working together. The temperature can be set within the range of 150-240°C. The default temperature is 210°C. This is optional function that can be work with rotisserie motor.
	Double grilling with fan: The inside radiant element and top element are working with fan the temperature can be set within the range of 150-240°C. The default temperature is 210°C.
	Convection: An element around the convection fan provides an additional source of heat for convection style cooking. In convection mode the fan automatically comes on to improve air circulation within the oven and creates an even heat for cooking. The temperature can be set within the range of 50-240°C. The default temperature is 180°C.

OPERATION INSTRUCTIONS



1. Clock Setting

After connecting the oven to the power, the symbols " 0:00 " will be visible on the display.









- 1> Press "", the hour figures will flash.
- 2> Rotate " K2 " to adjust the hour figures, (time should be within 0--23).
- 3> Press "", the minutes will flash.
- 4> Rotate " K2 " to adjust the minutes setting, (time should be within 0--59).
- 5> Press "" to finish the clock settings. " : " will flash, and the time will be illuminated.

Note: The clock is 24 hours. After power on, the clock will show " 0:00 " if not setting.



2. Function Setting

- 1> Rotate " K1 " to choose the cooking function you require. The related symbol will be illuminated .
- 2> Rotate " K2 " to adjust the temperature.
- 3> Press "" to start the cooking.
- 4> Press "" to start the cooking without step 2, and the default time is 9 hours and the default temperature will display on the LED.

Note:





- 1> The step quantities for the adjustment time of the knobs are as follow:
0--0:30min: step 1 minute 0:30--9:00hour: step 5 minutes
- 2> The step quantities for the adjustment of temperature is 5C, this can be adjusted under all cooking functions except " " " " " " "  " .
- 3> Rotate " K1 " to adjust the cooking time when cooking begins. Then press "" to confirm.
If "" not pressed within 3 seconds, the oven will revert back to the previous time to continue cooking.
- 4> Rotate" K2 " to adjust the temperature when cooking begins. The related indicator will be illuminated.
Then press "" to start cooking. If "" not pressed in 3 seconds, the oven will revert back to the previous temperature to continue cooking.

3. Lamp Setting

- 1> Rotate " K1 " to select the relevant function, then the corresponding icon will be on.
- 2> Press "" button to start, " 0:00 " and lamp icon " " will light up, " : " will flash.

4. Inquiring Function

In the following states, you can use inquiring function, after 3 seconds return to the current state.

- 1> During working state, if the clock was set, press "" button to see the current time; if the reminder function was set, press " () " button to see the time of reminder.
- 2> In reminding state, if the clock was set, press "" button to see the current time.
- 3> In clock display state, if the reservation function was set, press "" button to see the time of reservation.

5. Child lock Function

To Lock: press "▶" and "⏸" simultaneously for 3 seconds, there will be a long "beeping" sound and the "🔒" will be illuminated.

Lock quitting: press "▶" and "⏸" simultaneously for 3 seconds, there will be a long "beeping" sound indicating the child-lock is released.

6. Reminder Function

This function will help to remind you to start cooking in a certain time from 0:01 to 9:59. Only when oven in standby mode, the reminder can be set. Follow below to set the reminder:

- 1> Press reminder setting button "🔔 (🕒)";
- 2> Rotate "K2" to set the hour time of reminder. (Time should be within 0--9).
- 3> Press reminder setting button "🔔 (🕒)" again;
- 4> Rotate "K2" to set minute time of reminder. (Time should be within 0--59).
- 5> Press "▶" to confirm setting. The time will count down.

Note: The oven buzzer will sound 10 times when set reminder time is reached.

You can cancel the reminder during setting by pressing the stop button; After the reminder has been set, you can cancel it by pressing stop button twice.

7. Start/Pause/Cancel Function

- 1> If the cooking time has been set, press "▶" to start cooking. If the cooking is paused, press "▶" to resume cooking.
- 2> During cooking process, press "⏸" once to pause the cooking. Press "⏸" twice to cancel the cooking.

8. Energy-Saving Function

- 1> In waiting state and reminding state, press "▶" for three seconds, the LED display will go off and set to energy-saving mode.
- 2> If no operation in 10 minutes under waiting state, the LED display will go off and go into energy-saving mode.
- 3> Under the energy-saving mode, press any key or rotate any knob can quit the energy-saving mode.

9. Delay Cook Function

- 1> To use delay cook function, clock must be set in advance. Then, in the way of setting the clock, reserved time that oven starts to cook must be set (a> Press delay cook setting button "🕒", b> Rotate "K2" to set the hour time of delay cook. Time should be within 0--23. c> Press delay cook setting button "🕒" again; d> Rotate "K2" to set minute time of delay cook. Time should be within 0--59.), but don't press clock this time. Next, turn knob "K1" to choose function.
- 2> Press "▶" button to set cooking time and temperature. Then turn knob "K1" to adjust time, and "K2" to adjust temperature.

- 3> Press the "▶" button to finish cooking setting, and the clock will be on the screen with delay cook sign "⌘" always lighting. But no other function signals are presented. Delay cook time can be checked by pressing "⌘▶", 3 seconds later the screen will show clock again.
- 4> At the time of delay cook, cooking will start automatically after a buzzing sound. The delay cook sign "⌘" will put out, and other indicating signs will work normally.

Note:

- 1> Lamp, defrost, probe can't be delay cooked.
- 2> During the status of delay cook, press cancel button once, time and temperature of delay cook menu will be shown with menu icon lighting constantly. Press again, screen returns to clock, or press start button to return to delay cook status.
- 3> Reminder function is invalid during delay cook status.

10. Soft Closing Door (Optional)

When open the door angle $>30^\circ$, the door can be paused at any angle.

When open the door angle $\leq 30^\circ$, the door will close slowly under the action of the damper.

Please do not close the door vigorously.

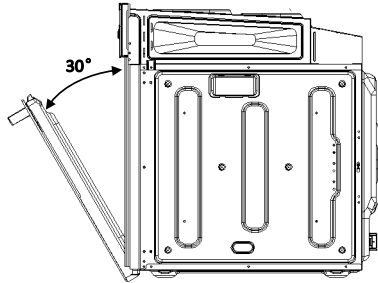

11. Note

- 1> The oven lamp will be on for all functions.
- 2> Once the cooking program has been set and the "▶" button is not pressed within 5 minutes, the current time will be displayed or turn back to waiting state. The setting program will be invalid.
- 3> The buzzer will sound once when buttons are effectively pressed, if they are not effectively pressed there will be no response.
- 4> The buzzer will sound five times to remind you when cooking has finished.

ACCESSORIES

ROTISSERIE SKEWER:

The average speed of the motor heat the food evenly. At the same time, it can guarantee the nutrition of the food.



Wire shelf: For grill dishes, cake pan with items for roasting and grilling.

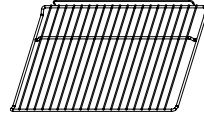

Universal pan: For cooking large quantities of food such as moist cakes, pastries, frozen food etc, or for collecting fat/ spillage and meat juices.

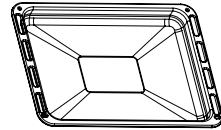

Telescopic runner: Some models may be supplied with telescopic runners . These telescopic runners and slider brackets could be disassembled by unscrewing the screws used to fix it. After disassembling,dishes and tray can be put on the side racks, using functions as Radiant grilling, Double grilling, Double grill with fan.

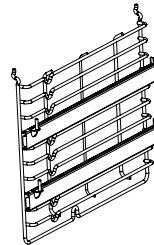

NOTE: When placing dishes on the oven floor, please DO NOT use functions with bottom heater to prevent heat gathering at bottom.
(only for specific models)

SHELF PLACEMENT WARNING

To ensure the oven shelves operate safely, correct placement of the shelves between the side rails is imperative. Shelves and the pan rack can be used between the first and fifth levels.

The shelves should be fitted correctly to ensure safe access and removal of dishes and hot food items.

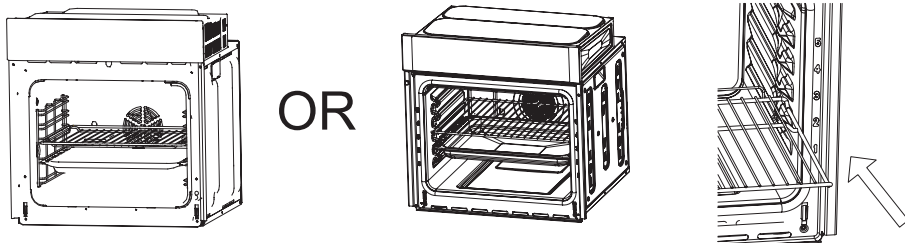

USE OF ROTISSERIE ACCESSORIES

The rotisserie works in combination with the grill element to heat the food equally. At the same time, it can guarantee the nutrition of the food.

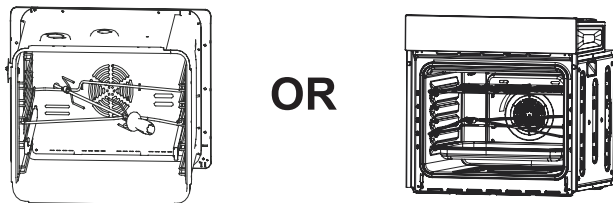

BULB REPLACEMENT

For replacement, process as follows:

- 1 > Disconnect power from the mains outlet or switch off the circuit breaker of the unit's mains outlet.
- 2 > Unscrew the glass lamp cover by turning it counter-clockwise (Note, it may be stiff) and replace the bulb with a new one of the same type.
- 3 > Screw the glass lamp cover back in place.

Note: Only use 25-40W/220V-240V, T300°C halogen lamps.

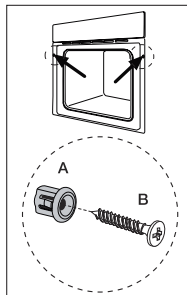
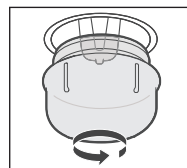

SECURING THE OVEN TO THE CABINET

1. Fit oven into the cabinet recess.
2. Open the oven door.
3. Secure the oven to the kitchen cabinet with two distance holders " A " which fit the holes in the oven frame and fit the two screws " B ".

VENTILATING OPENINGS

When cooking is finished or in pause state or in waiting state, if the oven's center temperature is over 75 degrees, the cooling fan will continue working for 15 minutes. Or when the oven's center temperature becomes lower than 75 degrees, the cooling fan will stop in advance.

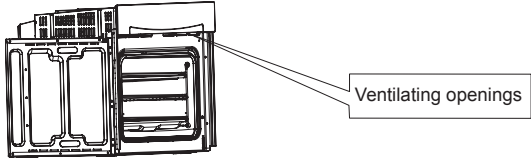

CONNECTION OF THE OVEN

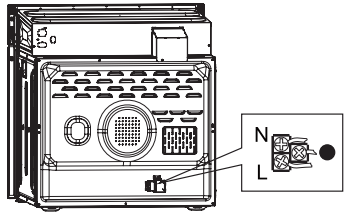

INSTALLATION

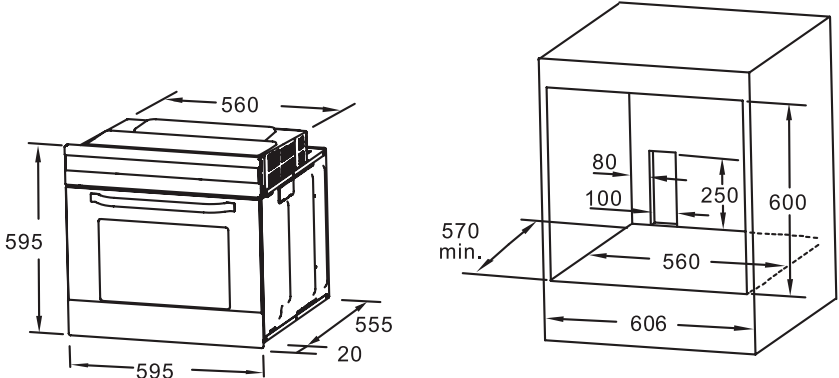

Remark:

1. The cabinet does not include the power switch or socket dimensions.

Note: The number of accessories included depends on the particular appliance purchased.

REMOVING THE DOOR FROM OVEN (OPTIONAL)

Disassembly of oven door components

1. To remove the door, open the door to the maximum angle. Then pull the buckle at the door hinge backward.

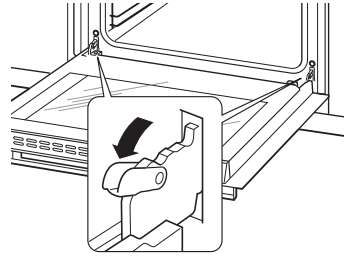

2. Close the door to an angle approximately 30°. Hold the door with one hand on each side. Lift up and slowly pull the door out from the oven.

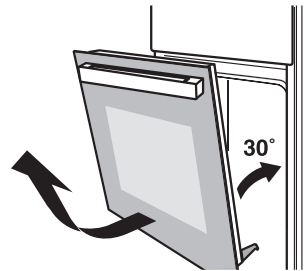

3. Open the door rotation bracket assembly. Refer the action in the following picture.

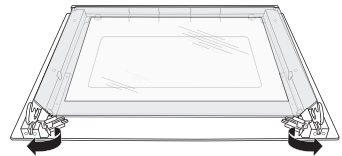

4. Lift up the inner glass door outer glass and pull it out, then take the middle glass door out in the same way.

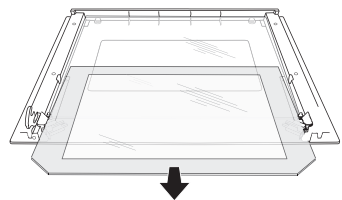

WARNING:
Don't forcibly pull out the door and take care with glass door panels during the dismantling process.

WARNING:
Ensure the hinge springs do not become loose, causing potential injury.

WARNING:
Do not lift or carry the oven door by the door handle.

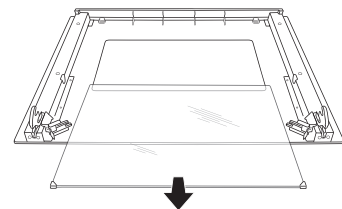

CLEANING AND MAINTENANCE

For the sake of a good appearance and reliability, keep the oven clean. The modern design of the unit facilitates maintenance to a minimum. The parts of the oven which come into contact with food have to be cleaned regularly.

- Before any maintenance and cleaning, disconnect the power.
- Set all controls in the OFF position.
- Wait until the oven interior has cooled down to slightly warm before cleaning.
- Clean the surface of the oven with a damp cloth, soft brush or fine sponge and then wipe dry.
- For cleaning the glass of the oven door, do not use abrasive cleaners or sharp metal scrapers, these can scratch the surface or lead to the glass being damaged.
- Never leave acidic substances (lemon juice, vinegar) on stainless steel parts.
- Do not use a high pressure cleaner for cleaning. The baking pans may be washed in mild detergent.

This appliance is marked according to the European directive 2012/19/EU on Waste Electrical and Electronic Equipment (WEEE).

By ensuring this product is disposed correctly, you will help prevent potential negative consequences for the environment and human health, which could otherwise be caused by inappropriate waste handling of this product. The symbol on the product indicates that this product may not be treated as household waste. Instead it shall be handed over to the applicable collection point for the recycling of electrical and electronic equipment. Disposal must be carried out in accordance with local environmental regulations for waste disposal. For more detailed information about treatment, recovery and recycling of this product, please contact your local city office, your household waste disposal service or the shop where you purchased the product.



Maintenance Schedule:

To ensure the appliance continues to operate at peak performance, we recommend a routine service call every 3 years for the life of the appliance.

FOR SPARE PARTS OR TO FIND THE ADDRESS OF
YOUR NEAREST STATE SPARE PARTS CENTRE IN AUSTRALIA

MIDEA HOME APPLIANCES AUSTRALIA PTY LTD
11/75 Lorimer Street, Docklands, Melbourne, 3008
After-sales service No.: 1800 88 60 10