

# Hisense

life reimagined

## USER'S OPERATION MANUAL

Before operating this unit, please read this manual thoroughly, and retain for future reference.

### Dishwasher

HSBE15FS

EN

English

# Contents

<b>Your dishwasher</b> .....	<b>4</b>
<b>Safety instructions</b> .....	<b>5</b>
Installation .....	6
Overflow guard function .....	6
Winter storage/transport .....	6
Packaging .....	7
Disposal .....	7
<b>Before washing for the first time</b> .....	<b>8</b>
Water hardness .....	8
Basic settings .....	8
Top up with rinse aid .....	8
<b>Greener dishwashing</b> .....	<b>9</b>
Save energy and water .....	9
<b>Loading the dishwasher</b> .....	<b>10</b>
Fragile dishes .....	10
Loading affects the results .....	10
The dishwasher's baskets .....	10
Top cutlery tray .....	10
Upper basket .....	11
Lower basket .....	12
<b>Using the dishwasher</b> .....	<b>13</b>
Add detergent .....	13
On/Off .....	14
Child lock .....	14
Select program .....	14
Select option .....	15
Start/Pause/Stop .....	16
If you want to load more dishes .....	16
Power failure .....	16
Check washing times .....	16
Once the program has finished .....	16
The best drying results .....	16
Unloading the dishwasher .....	16
<b>Program chart</b> .....	<b>17</b>
<b>Settings</b> .....	<b>18</b>
<b>Care and cleaning</b> .....	<b>20</b>
Top up with rinse aid .....	20
Clean filter .....	20
Cleaning the spray arms .....	21
Clean the outside of the dishwasher .....	22
CLn - Run the Self-clean program .....	22
Remove blockages .....	22



<b>Troubleshooting</b> .....	<b>24</b>
General .....	24
<b>Installation</b> .....	<b>28</b>
Safety instructions .....	28
Transport protection for the door .....	28
Placing the dishwasher .....	28
Adjust the height and slide the dishwasher into place .....	29
Drainage connection .....	30
Connection to water supply .....	31
Electrical connection .....	31
Remove dishwasher worktop .....	31
<b>Service</b> .....	<b>32</b>
<b>Technical data and energy labelling</b> .....	<b>33</b>
Information on energy label .....	33
Technical data .....	33
Information for consumers .....	33
Test standard .....	33







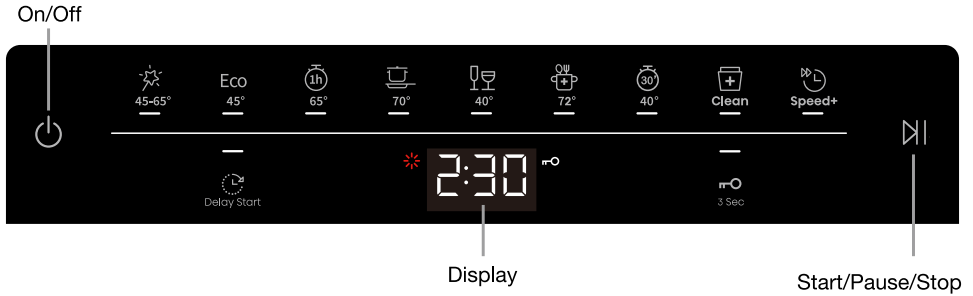

# Your dishwasher

Install the dishwasher, see the chapter *Installation*. Press .



The first time the dishwasher is switched on, it is important that you choose the right settings to ensure good dishwashing results. See the chapter *Before washing for the first time*.



## PROGRAMS



-  Auto 45-65°
- Eco Eco 45°
-  1h 65°
-  Intensive 70°
-  Glass 40°
-  Hygiene 72°
-  Quick 40°
-  Self-clean

## OPTIONS

-  Speed+
-  Delay Start
-  Child Lock

## Information on the display

See the chapter *Care and cleaning*.

-  Top up with rinse aid
-  Child lock indicator
- CLn Run the Self-clean program

## NOTE!

The control panel only reacts to use when the door is closed.

# Safety instructions

- Read the operating instructions and keep them in a safe place!
- Number of standard place settings: 15
- Never use the dishwasher for any purpose other than that specified in these operating instructions.
- Do not load the dishwasher door or dishwasher baskets with anything other than dishes.
- The door should not be left in the open position since this could present a tripping hazard.
- Push the baskets in to avoid risking the dishwasher tripping over.
- Use only dishwasher detergent!
- This appliance can be used by children aged from 8 years and above and persons with reduced physical, sensory or mental capabilities or lack of experience and knowledge if they have been given supervision or instruction concerning use of the appliance in a safe way and understand the hazards involved. Children shall not play with the appliance. Cleaning and user maintenance shall not be made by children without supervision.
- This appliance is not intended for use by persons (including children) with reduced physical, sensory or mental capabilities, or lack of experience and knowledge, unless they have been given supervision or instruction concerning use of the appliance by a person responsible for their safety. Children should be supervised to ensure that they do not play with the appliance.
- If the supply cord is damaged, it must be replaced by the manufacturer, its service agent or similarly qualified person in order to avoid a hazard.
- Only use the dishwasher in household-type environments for dishwashing household dishes. All other use is prohibited.
- Never place dishes with solvent residues in the dishwasher due to the risk of explosion. Nor may dishes that contain ash, wax or lubricants be washed in the dishwasher.

- Children must be watched. Do not allow children to use or play with the dishwasher. Be especially vigilant when the door is open. Some detergent may remain inside! After adding detergent, always start the dishwasher immediately.

 **WARNING!**

Knives and other utensils with sharp points must be loaded in the basket with their points down or placed in a horizontal position.

 **WARNING!**

Children must be supervised—dishwasher detergent is corrosive!

 **WARNING!**

Dishwasher detergents are strongly alkaline. They can be extremely dangerous if swallowed. Avoid contact with skin and eyes and keep children away from the dishwasher when the door is open. Seek medical attention if swallowed.

Check that the detergent compartment is empty after completion of the wash cycle.

## Installation

See the chapter *Installation*.

## Overflow guard function

The overflow guard starts pumping out the machine and turns off the water supply if the water level in the dishwasher exceeds the normal level. If the overflow guard is triggered, F54 (Overfilling water) appears on the display. Turn off the water tap and contact your nearest service centre. (To avoid water leakage outside the dishwasher, do not remove the plug from the wall socket until the water tap on the supply line has been turned off!)

## Winter storage/transport

Store the dishwasher above freezing and avoid long transport distances in very cold weather. Transport the dishwasher upright or laying on its back.

Before transporting a used dishwasher, or before prolonged storage, water must first be removed from the machine.

## Packaging

The outer packaging protects the product during transport. The packaging material is recyclable. Separate the different packaging materials to help reduce raw material use and waste. Your dealer can take the packaging for recycling or direct you to the nearest recycling centre. The packaging is comprised of:

- Corrugated cardboard made from up to 100% recycled material.
- Expanded polystyrene (EPS) with no added chlorine or fluorine.
- Supports made from untreated wood.
- Protective plastic made from polyethylene (PE).

## Disposal

The dishwasher is manufactured and labelled for recycling. When the dishwasher has reached the end of its service life and is to be disposed of, it should immediately be made unusable. Pull out the power cable and cut it as short as possible.

Contact your local authority for information about where and how your dishwasher should be correctly recycled.



This symbol on the product or in its packing indicates that this product may not be treated as household waste. Instead, it should be taken to the appropriate waste collection point for the recycling of electrical and electronic equipment. By ensuring this product is disposed of correctly, you will help prevent potential negative consequences for the environment and human health, which could otherwise be caused by the inappropriate waste handling of this product. For more detailed information about the recycling of this product, please contact your local council your household waste disposal service, or the shop where you purchased the product.

# Before washing for the first time

## Water hardness

In order to achieve good dishwashing results, the dishwasher needs soft water (water with low mineral content). Hard water leaves a white coating on dishes and the dishwasher.

## Checking water hardness

Contact the local water utility to check the water hardness in your area. This is important with regard to how much detergent and rinse aid to use.

## Basic settings

The first time the dishwasher is switched on, it is important that you choose the right settings to ensure good dishwashing results. See the chapter *Settings*.

Set up:

- Rinse aid
- TAB

## ✧ Top up with rinse aid

Drying is faster and a better result is achieved if you use rinse aid. You will also achieve a better dishwashing result with clear and spotless dishes.

Top up the rinse aid compartment with rinse aid if you have selected Rinse aid 01 - 05.

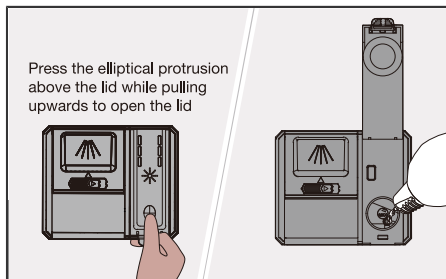

1. Open the rinse aid compartment lid.
2. Carefully top up with rinse aid to the level marked **MAX**.
3. Wipe up any splashes of rinse aid around the compartment.
4. Close the lid firmly.

For water with a hardness greater than 10–12 °dH, you ought to use rinse aid with citric acid (known as acid rinse aid).

# Greener dishwashing

## Save energy and water

When using a dishwasher in a residential setting, less energy and water are generally used compared to washing the dishes by hand.

### Do not rinse under running water

Do not rinse the dishes under running water as this will lead to increased energy and water consumption. Simply scrape off large food particles before loading the dishwasher.

### Choose a green detergent

Read the environmental declaration on the packaging!

Too much detergent and rinse aid can result in less effective dishwashing and also entail greater environmental impact.

### Run a fully loaded dishwasher

Save energy and water by waiting until the dishwasher is full before running a program (see number of standard place settings). Use the 1h 65° program with the Speed+ option to rinse the dishes if there are any unpleasant odours.

### Run programs at a lower temperature

If the dishes are only slightly dirty, you can select a program with a low temperature.

### Select dishwashing program - Eco 45°

This program is suitable for washing normally soiled dishes and is the most effective program in terms of combined energy and water consumption.

The dishwashing program is designed for an effective wash using as little energy and water as possible. The program washes at a low temperature for a long time.

### Connect to cold water

Connect the dishwasher to the cold water supply if the building is heated using oil, electricity or gas.

### Connection to hot water supply

Connect the dishwasher to the hot water supply (max. 60 °C) if the building is heated using an energy-efficient means such as district heating, solar power or geothermal power. Choosing a hot water connection reduces the dishwasher's energy consumption.

### NOTE!

Do not exceed the permitted water supply temperature. Certain materials used in some cookware cannot withstand high heat. See *Fragile dishes* in the chapter *Loading the dishwasher*.

# Loading the dishwasher

## Fragile dishes

Some cookware is not dishwasher safe. This can be for several reasons. Some materials cannot withstand high heat, others can be damaged by dishwasher detergent.

Exercise caution with, for example, handmade items, fragile decoration, crystal/glassware, silver, copper, tin, aluminium, wood and plastic. Look for the "Dishwasher safe" marking.

## Loading affects the results

Load the dishes carefully to ensure the best washing and drying results with the lowest possible energy and water consumption. Give your dishwasher the best chance to reach and clean all surfaces, as well as to dry the dishes as thoroughly as possible.

- All dirty surfaces should face inwards and downwards!
- Dishes should not be placed in or on each other.
- Angle dishes with hollows, such as cups, so that the rinse water will run off. This is also important for plastic items.
- Make sure small items cannot fall through the dishwasher basket; place them in the top cutlery tray.

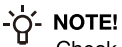

### NOTE!

Check that the spray arms can rotate freely.

## The dishwasher's baskets

The dishwasher is equipped with a top cutlery tray, an upper basket and a lower basket.

The appearance of the baskets may differ depending on the dishwasher setup.

## Top cutlery tray

The top cutlery tray has space for cutlery, ladles, whisks, serving cutlery and similar items.

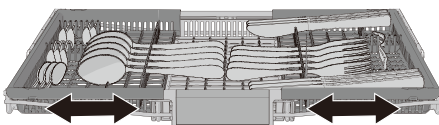
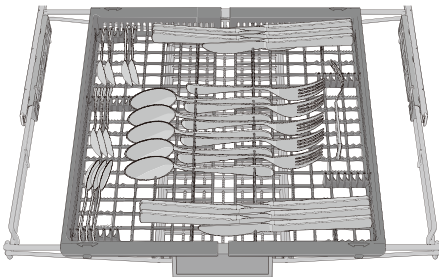

The top cutlery tray is comprised of three parts that can be moved sideways to better accommodate the dishes.

# Upper basket

Place glasses, cups, bowls, side plates and saucers in the upper basket. All dirty surfaces should face inwards and downwards! Wine glasses are placed on the wine glass shelf and knives are placed in the knife stand on the right.

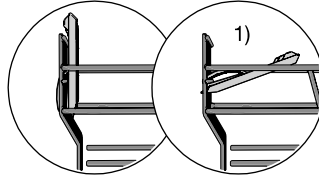
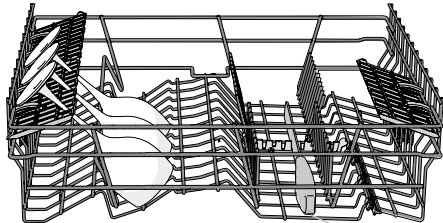
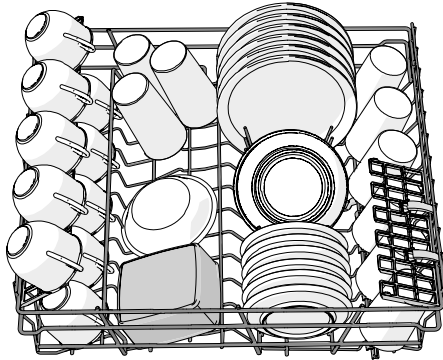

2 positions

1) When the basket in upper position, make sure the cup holder is in this position.

## Adjusting the height of the upper basket

1. Pull out the upper basket.

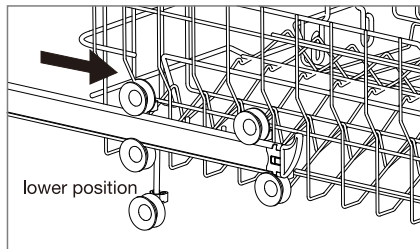

2. Remove the upper basket.

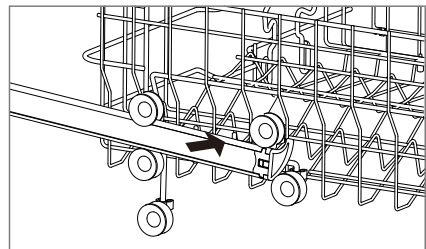

3. Re-attach the upper basket to upper or lower rollers.

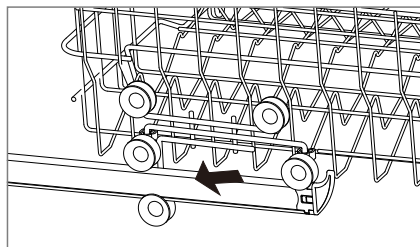

4. Push in the upper basket.

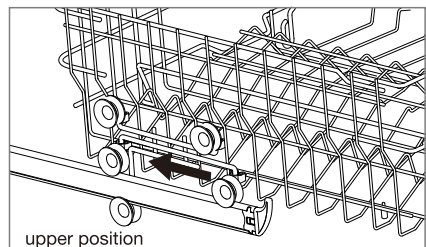

## Lower basket

Place plates, side plates, serving dishes and pots in the lower basket. Cutlery can be placed in the cutlery holder.

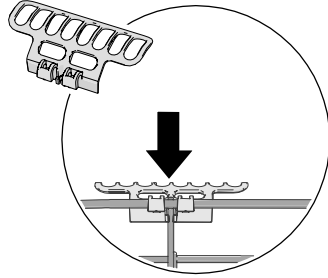
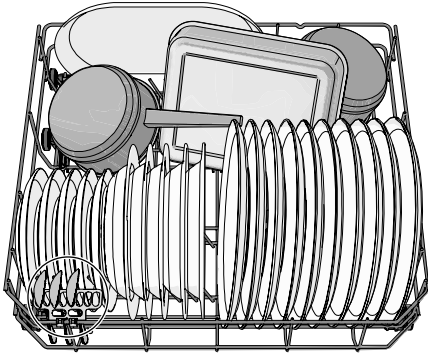

Fit the cutlery holder to achieve maximum loading capacity. (Found inside the enclosed plastic bag.)

## Adjustable plate supports

The adjustable plate supports can be folded down to make it easier to load pots and bowls.

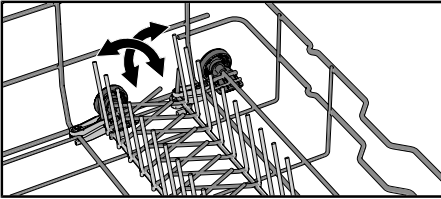

# Using the dishwasher

## Add detergent

Follow the instructions on the detergent packaging. And use detergent and rinse aid doses suitable for soft water.

Too much detergent can result in less effective dishwashing and also entails greater environmental impact.

### Detergent compartment

The detergent compartment must be dry when adding detergent.

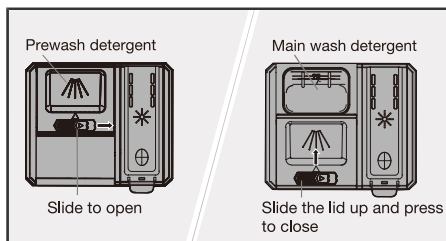

If powder or liquid dishwasher detergent is used, add a small amount of the detergent to the compartment for prewash detergent.

### NOTE!

Use only dishwasher detergent! Washing up liquid must not be used as the foam that forms prevents the dishwasher from operating effectively.

### All-in-one detergent

There are many types of all-in-one detergents on the market. Read through the directions for these products carefully.

Activate the TAB setting when using an all-in-one detergent that contains rinse aid.

Dishwasher tablets are not recommended for short programs (less than 75 minutes). Use powder or liquid dishwasher detergent instead.

### NOTE!

Optimal washing and drying results are achieved by using normal detergent together with separately dispensed rinse aid.

Contact the detergent manufacturer if you have questions about the detergent.

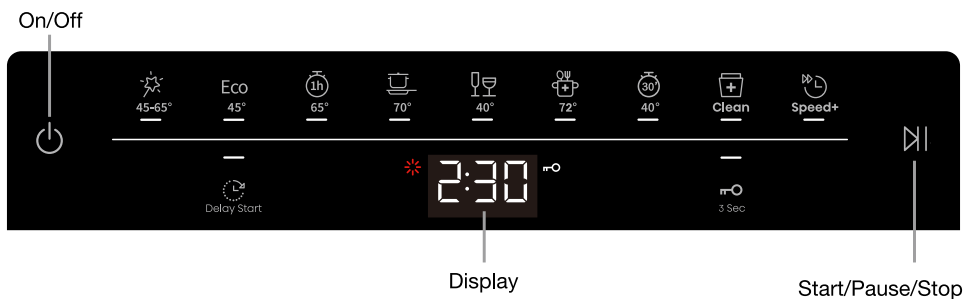

## NOTE!

The control panel only reacts to use when the door is closed.

## On/Off

Close the door properly, otherwise the dishwasher will not start. Press . Also turn on the water tap if it is turned off.

When the program is not running, press to turn off the dishwasher immediately. If the program runs, press and hold for three seconds to shut down the dishwasher. Alternatively, press to pause the dishwasher, then press to turn off.

## Child lock

To prevent children from stopping the current dishwashing program, you can activate the child lock function. Once you have started a program, press and hold for three seconds. And CL(Child Lock) will be shown on the display when pressing the control panel. (To unlock, press and hold for three seconds.)

## Select program

Select a program to suit the type of dishes and how dirty they are.

Press the desired program until it is activated, which is indicated by an indicator light.

### Auto 45-65°

The dishwasher can measure how dirty the dishes are and adjust water consumption and temperature accordingly. When newly installed, the program needs to be run five times before it is fully adapted and can provide the best results.

### Eco Eco 45°

This program is suitable for washing normally soiled dishes and is the most effective program in terms of combined energy and water consumption.

You can read more about greener dishwashing in the chapter *Greener dishwashing*.

For heavily soiled dishes with a lot of grease, a program with higher temperatures should be used.

### 1h 65°

A quick program for slightly dried leftovers. (This program is not intended for burnt food, such as on oven dishes.)



## Intensive 70°

A program with a high temperature for dissolving grease on very dirty dishes, such as pans, casserole dishes and oven dishes. If these dishes do not completely fill the dishwasher, you can add plates and other dishes.



## Glass 40°

A gentle dishwashing program with a low temperature for washing fragile items made of crystal/glass. Remember to use a small amount of detergent and to place items so that they do not touch each other during the wash. See also *Fragile dishes* in the chapter *Loading the dishwasher*. Porcelain that has just been used without dried leftovers can also be washed using this program.



## Hygiene 72°

This program is ideal to use where demands on hygiene are extra high, e.g. for baby bottles and cutting boards. The temperature is high both in the main wash and in the final rinse.



## Quick 40°

A shorter wash for lightly soiled loads that do not need drying.





## Self-clean

Self-cleaning program for hygienic cleaning of the dishwasher tub, spray arms and spray pipes. This program should be run (with no dishes in the machine) using normal dishwasher detergent or citric acid. Special dishwasher cleaners are also available on the market. For the removal of limescale deposits, see *Dishwasher tub* in the chapter *Care and cleaning*.

The dishwasher will indicate at regular intervals that Self-clean needs to be run.

Press  to select the program. When Self-clean cycle runs, display shows CLn and remaining washing time alternatively.

## Select option

Press the options (, ) to activate them. (The available options vary between programs.)



## Speed+

This option shortens the program time, but uses more energy and water.



Press  to activate the option. The program time is updated on the display.

*Not available for: Auto 45-65°, Glass 40°, Hygiene 72°, Self-clean, Quick 40°*



## Delay Start

When you select Delay start, the dishwasher will start 1-24 hours after you press .

1. Press  once to activate Delay start. Press several times, or hold it on, to set the desired number of hours. The time for Delay start is shown on the display.
2. Press . The timer counts down and the dishwasher starts after the selected delay.



If you want to cancel the Delay start option, press and hold  for three seconds.

*Not available for: Self-clean*

## Start/Pause/Stop

Press  . The display starts counting down.

### Stopping or changing a program



Press  to pause the program. If you want to interrupt or change the program after starting the dishwasher, press and hold  for three seconds.

Open the door and top up with new detergent if the lid of the detergent dispenser has opened. Close the door. Then select a new program and press .

### Remaining time

Once you have chosen a program and options, the total time is displayed.



### If you want to load more dishes<sup>1)</sup>

Press  to pause the program. Open the door. Add the dishes and close the door. Press .

### Power failure

If the dishwasher is turned off due to a power failure when a dishwashing program is running, the program continues when power is restored. If the power is cut during drying, the program is interrupted.

### Check washing times

When the dishwasher is turned on, press and hold  and , and the screen will display the number of times the dishwasher has been washed. Release the button to exit.

### Once the program has finished

Once the program has finished, "End" appears on the display. And the dishwasher turns off after the buzzer makes a sound.

The dishwasher switches off automatically after the program ends. Shut off the water tap after each use.

### The best drying results

- Fully load the dishwasher.
- Angle dishes with hollows, such as cups, so that the rinse water will run off. This is also important for plastic items.
- Top up with rinse aid or increase the rinse aid dosage setting.
- Allow the dishes to cool before unloading the dishwasher.







### Unloading the dishwasher

Hot porcelain is more fragile. Leave the dishes to cool in the dishwasher before unloading them.

Unload the lower basket first to avoid any water drops from the upper basket falling onto the dishes in the lower basket.

<sup>1)</sup> You should not load more dishes if the lid of the detergent dispenser has been opened.







# Program chart

Program	Detergent (g)	Option	Number of pre-washes	Main wash	Number of rinses	Final rinse	Consumption values <sup>1)</sup>		
							Dishwashing time (approx. hrs:min)	Energy (approx. kWh)	Water cons. (liter)
 Auto 45-65°	25		1-2	45-65 °C	2-3	60 °C	2:10-3:10	0.9-1.4	12.0-19.0
Eco Eco 45° <sup>2)</sup>	33		1	44 °C	2	46 °C	4:16	0.788	12.8
 1h 65°	25			65 °C	3	65 °C	1:00	1.2	13.0
 Intensive 70°	25		2	70 °C	2	70 °C	2:50	1.6	15.5
 Glass 40°	20			40 °C	2	50 °C	1:40	0.7	10.0
 Hygiene 72°	25			70 °C	2	72 °C	1:05	1.3	9.5
 Quick 40°	--			40 °C	1	40 °C	0:30	0.3	6.6
 Self-clean	25			70 °C	2	70 °C	1:05	1.4	10.0

<sup>1)</sup> Consumption values vary depending on the temperature of the incoming water, room temperature, load size, selected additional functions and more. The consumption values for the **Eco 45°** program are accurate, others are indicative only.

<sup>2)</sup> The program **Eco 45°** is recommended for a normally soiled load equal to the rated capacity of the dishwasher.

# Settings

1. Press .
2. To open the dishwasher's settings menu, press and hold  and  until SET is shown on the display.
3. Press  to step through the setting menu.
4. Press  to step through the alternatives .
5. Confirm the selected setting by pressing .
6. To exit the menu, step through it or pressing .

Open the dishwasher's settings menu



Select alternative

Confirm / Next setting

Settings		Alternatives	
2	Sounds	00 - 03	A beep confirms that the control panel has been pressed. A beep indicates when a dishwashing program has ended. Error messages are always indicated by a loud buzzer.
3	Rinse aid	00 - 05	<p>Setting for rinse aid dosage. The rinse aid dispenser can be adjusted between 00 (Off) and 05 (High dosage). Increase the rinse aid dosage:</p> <ul style="list-style-type: none"> <li>• If the dishes have water marks.</li> </ul> <p>Decrease the rinse aid dosage:</p> <ul style="list-style-type: none"> <li>• If the dishes have a sticky white/blue film.</li> <li>• If the dishes are streaked.</li> <li>• Build-up of foam. If you have very soft water, the rinse aid can be diluted 50:50 with water.</li> </ul> <p><i>Pre-selected at factory: 03</i></p>

Settings		Alternatives	
5	TAB	00 (Off) 01 (On)	Activate this setting when using an all-in-one detergent that contains rinse aid. This setting reduces the rinse aid dose. <i>Pre-selected at factory: 00</i>
F--	Error readout		Any error messages. When contacting the service department, you may be asked to provide the most recent error messages.
rSt	Restore factory defaults		Restores all settings to the factory defaults. Select rSt and press $\Delta$  .
End	Exit		To exit the dishwasher's settings menu, select End and press $\text{⏏}$ or wait for three seconds.

# Care and cleaning

## ✧ Top up with rinse aid

When the rinse aid needs topping up, the above symbol lights on the display.

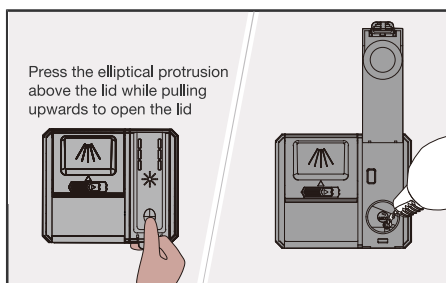

1. Open the rinse aid compartment lid.
2. Carefully top up with rinse aid to the level marked **MAX**.
3. Wipe up any splashes of rinse aid around the compartment.
4. Close the lid firmly.

After topping up, it may take a while before the symbol goes out.

### 💡 NOTE!

For water with a hardness greater than 10-12 °dH, you ought to use rinse aid with citric acid (known as acid rinse aid).

## Clean the filter

The filter traps larger food particles, which cannot get past the drainage pump. Empty the filter when necessary. It should be cleaned at regular intervals depending on how often the dishwasher is used.

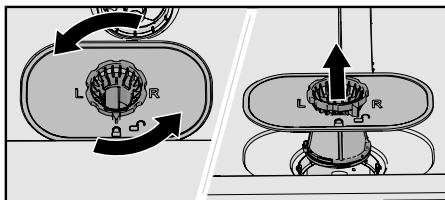

1. Turn the locking ring anticlockwise and lift the filter straight up.
2. Empty and clean the filter.
3. Refit the filter and turn the locking ring clockwise to its stop position. Check that the edges seal properly.

### 💡 NOTE!

Dishwashing results may be affected if the filter is fitted incorrectly. The dishwasher must not be used without the filter in place!

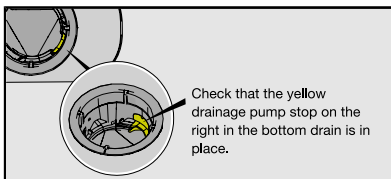

# Cleaning the spray arms

Holes and bearings can sometimes become blocked. Remove any debris using a pin or the like. The spray arms also have holes underneath.

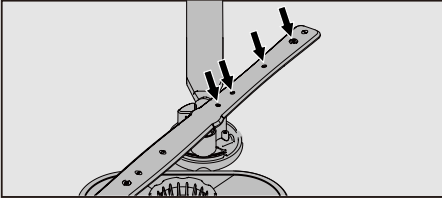

To facilitate cleaning you can remove the spray arms. Remember to fit them firmly back into place afterwards.

## Top spray arm

- Pull out the top cutlery tray. Unscrew the top spray arm bearings anticlockwise to remove the spray arm.

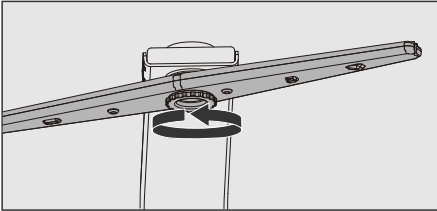

## Upper spray arm

- Pull out the upper basket.
- Unscrew the spray arm bearings anticlockwise to remove the spray arm from the upper basket.

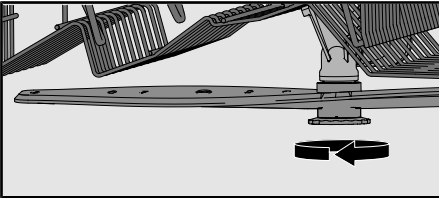

## Lower spray arm

- Pull the lower spray arm straight up to release it.

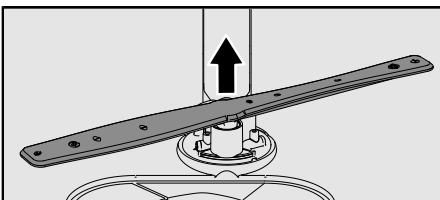

# Clean the outside of the dishwasher

## Door and door seal

Open the door. Clean the sides of the door and the door seal regularly with a slightly damp cloth. Clean the door seal at the lower front edge of the dishwasher with a washing-up brush.

## Control panel

Keep the control panel clean. If necessary, wipe it with a dry or slightly damp cloth. Never use cleaning products – they may scratch the surface.

# CLn - Run the Self-clean program

## Dishwasher tub

The dishwasher tub is made of stainless steel and is kept clean through normal use (when used regularly).

If you have hard water, limescale deposits may build up in the dishwasher. If this happens, run Self-clean with two tablespoons of citric acid in the detergent compartment (with no dishes in the machine). Special dishwasher cleaners are also available on the market.

# Remove blockages

## Unblocking the drainage pump

If the dishwasher still contains water after the program has finished, something may be blocking the drainage pump, which results in the Water outlet fault error message.

1. Turn off the machine using  $\odot$  and remove the plug from the wall socket.
2. Remove the filter.
3. Scoop out the water from the dishwasher tub.
4. In order to inspect the drainage pump, remove the yellow drainage pump stop on the right in the bottom drain. (Use a pair of pliers if necessary.)
5. Turn the pump wheel located behind the drainage pump stop by hand. Carefully remove any sharp items, such as glass.
6. Refit the drainage pump stop. Refit the filter.
7. Plug the machine in again.

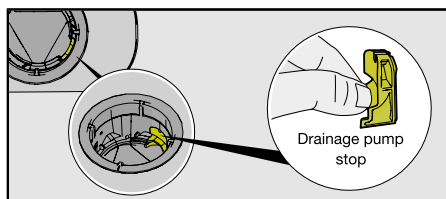

## NOTE!

Do not forget to refit the drainage pump stop.

## Cleaning the inlet hose filter

If the water supply contains small particles, the outer filter on the inlet hose may become blocked, which results in the Water inlet fault error message.

1. Turn off the machine using  and remove the plug from the wall socket.
2. Turn off the water tap.
3. Unscrew the inlet hose.
4. Carefully clean the inlet hose.
5. Screw the inlet hose firmly into place.
6. Plug the machine into the wall socket and turn on the water tap. Allow the pressure to settle for a while and check that the connection is watertight.

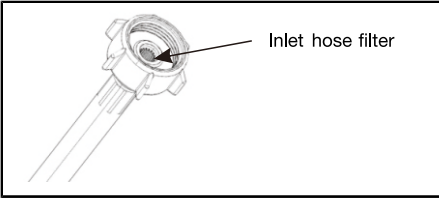

# Troubleshooting

Error messages		Action
<b>F11</b>	Water outlet fault	See <i>Water remains in the dishwasher</i> in the table <i>Problem</i> below. If the problem persists, contact your nearest service centre.
<b>F12</b>	Water inlet fault	Check that the water tap is on. Check that the outer filter on the inlet hose is not blocked. See <i>Cleaning the inlet hose filter</i> in the chapter <i>Care and cleaning</i> . If the problem persists, contact your nearest service centre.
<b>F40</b>	Inlet valve leakage	Turn off the water tap and contact your nearest service centre.
<b>F41</b>	Heater fault	Turn off the water tap. Remove the plug from the wall socket and contact your nearest service centre.
<b>F42</b>	NTC fault	Turn off the water tap and contact your nearest service centre.
<b>F43</b>	Water level fault	Turn off the water tap and contact your nearest service centre.
<b>F45</b>	Diverter fault	Contact your nearest service centre.
<b>F54</b>	Overfilling water	Turn off the water tap and contact your nearest service centre. To avoid water leakage outside the dishwasher, do not remove the plug from the wall socket until the water tap on the supply line has been turned off!
<b>F65</b>	Communication fault	Contact your nearest service centre.

Press  to clear the error message except for F54. After the dishwasher appears F54 error, it can only be turned off when the error is cleared.

## General

Problem	Possible causes	Action
The control panel does not react when pressed.	You have pressed the control panel too soon after closing the door.	Wait a moment then try again.
	The door is open.	The control panel only reacts to use when the door is closed.
	Child lock is activated.	See the chapter <i>Using the dishwasher</i> .
	Dirt on the control panel.	Clean with a dry or slightly damp cloth.
Cannot close door.	The baskets are not correctly positioned.	Check that the baskets are correctly positioned horizontally.
		Check that the dishes are not blocking the baskets from sliding properly into place.

<b>Problem</b>	<b>Possible causes</b>	<b>Action</b>
The dishwasher does not start.	▶  has not been pressed.	Press ▶  . The display starts counting down.
	The door is not properly closed.	Check.
	You have opened the dishwasher to add more dishes while a program is in progress.	Close the door and press ▶  .
	Check whether the Delay start option has been selected.	Press and hold ▶  for three seconds if you want to cancel the Delay start option.
	The plug is not plugged into the wall socket.	Check.
	A fuse/circuit breaker has been tripped.	Check.
The dishes are not clean.	The spray arms do not rotate.	Check that the dishes are not blocking the spray arms.
	Spray arm holes or bearings blocked.	Clean the spray arms. See the chapter <i>Care and cleaning</i> .
	Unsuitable dishwashing program.	Select a program with a high temperature to dissolve grease on very dirty dishes, such as Intensive 70°.
	Incorrect detergent dosage.	Dose according to water hardness. Far too much or far too little detergent results in poorer dishwashing results.
	Old detergent. Detergent is a perishable product.	Avoid large packages.
	Glasses and cups have toppled over during the program.	Place dishes to sit steady.
	Dishes loaded incorrectly.	Do not cover porcelain with large bowls or the like. Avoid placing very tall glasses in the corners of the baskets. See the chapter <i>Loading the dishwasher</i> .
	The filter is clogged.	Clean the filter.
	The filter is not fitted correctly.	Check that the filter is fitted correctly. See the chapter <i>Care and cleaning</i> .
Drainage pump stop missing.	Check that the yellow drainage pump stop on the right in the bottom drain is in place. See the chapter <i>Care and cleaning</i> .	

<b>Problem</b>	<b>Possible causes</b>	<b>Action</b>
Spots on stainless steel or silver.	Some foodstuffs, such as mustard, mayonnaise, lemon, vinegar, salt and dressings, can cause spots on stainless steel if left for too long.	Rinse off these types of foodstuffs if not starting the dishwasher immediately. Consider using 1h 65° with the Speed+ option.
	All stainless steel can cause spots on silver if they come into contact during dishwashing. Aluminium can also cause spots on dishes.	In order to avoid marks and tarnishing, separate dishes made from different metals, such as silver, stainless steel and aluminium.
Spots or films on the dishes.	Incorrect rinse aid dosage setting.	See the chapter <i>Settings</i> .
	The setting TAB is activated and all-in-one detergent with insufficient drying effect is being used.	Switch all-in-one detergents or deactivate the TAB setting and top up with separate rinse aid. See <i>Rinse aid</i> in the chapter <i>Settings</i> .
	Too high temperature and/or too much detergent can cause etching on crystal. Unfortunately, this cannot be repaired, only prevented.	Wash crystal at a low temperature and with a conservative amount of detergent. Contact the detergent manufacturer.
The dishes have a sticky white/blue film.	Rinse aid dosage setting too high.	Reduce the dosage. See the chapter <i>Settings</i> . If you have very soft water, you may want to dilute the rinse aid 50:50 with water.
Spots left after washing.	Lipstick and tea can be difficult to wash off.	Use a detergent with a bleaching agent.
Detergent residue in the detergent compartment after dishwashing.	The detergent compartment was damp when adding detergent.	The detergent compartment must be dry when adding detergent.
	The detergent compartment has been blocked.	Check that the dishes are not preventing the detergent compartment from opening.
Rattling sound when dishwashing.	The dishes are not correctly placed or the spray arms are not rotating.	Check that the dishes are placed securely. Spin the spray arms to make sure they can rotate.

<b>Problem</b>	<b>Possible causes</b>	<b>Action</b>
Water remains in the dishwasher.	The filter is clogged.	Clean the filter.
	The filter is not fitted correctly.	Check that the filter is fitted correctly. See the chapter <i>Care and cleaning</i> .
	Debris in the drainage pump.	Clean the drainage pump. See the chapter <i>Care and cleaning</i> .
	Drainage pump stop missing.	Check that the yellow drainage pump stop on the right in the bottom drain is in place. See the chapter <i>Care and cleaning</i> .
	Kink in drainage hose.	Check that the hose is free from kinks and sharp bends.
	Blocked drainage hose.	Disconnect the drainage hose where it connects to the sink unit's water trap. Check that no debris has fastened and that the connection has an inner diameter of at least 14 mm.
Bad odour in dishwasher.	Dirt around the seals and in corners.	Clean with washing-up brush and low foaming cleaner.
	Low temperature programs have been selected for a prolonged period.	Run a program with a high temperature once or twice a month. Or run a self-cleaning program. See <i>Self-clean</i> in the chapter <i>Using the dishwasher</i> .
Grease deposits in the dishwasher.	Low temperature programs have been selected for a prolonged period.	Select a program with a high temperature to dissolve grease on very dirty dishes, such as Intensive 70°. Or run a self-cleaning program. See <i>Self-clean</i> in the chapter <i>Using the dishwasher</i> .
The dishes are not dry enough.	The dishwasher is not fully loaded.	Fully load the dishwasher.
	Rinse aid needs topping up or dosage is set too low.	Top up with rinse aid or increase the rinse aid dosage setting.
	The setting TAB is activated and all-in-one detergent with insufficient drying effect is being used.	Switch all-in-one detergents or deactivate the TAB setting and top up with separate rinse aid. See <i>Rinse aid</i> in the chapter <i>Settings</i> .

# Installation

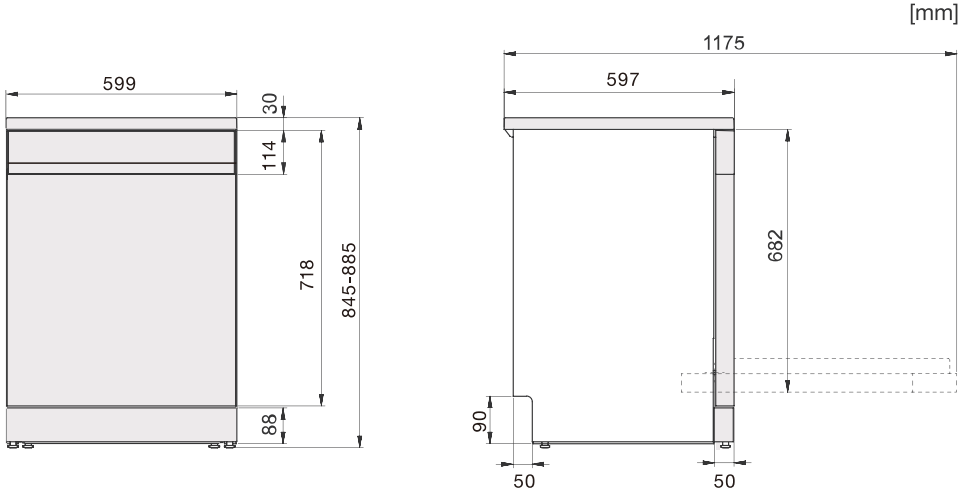

Nominal dimensions. Actual measurements may vary.

## Safety instructions

- Connections to electricity, water and drainage must be performed by a qualified professional.
- Always follow applicable regulations for water, drainage and electricity.
- Take care during installation! Wear protective gloves! There must always be two people!
- Place a drip tray on the floor beneath the dishwasher to prevent damage from any water leaks.
- Before screwing the dishwasher into place, test the dishwasher by running the 1h 65° program with the Speed+ option. Check that the dishwasher fills with water and drains. Check also that none of the connections leak.

### **WARNING!**

Turn off the water supply when installing the dishwasher!

The plug must be disconnected or power to the socket turned off while the work is carried out!

## Transport protection for the door

Do not forget to remove the transport protection for the door when unpacking the dishwasher.

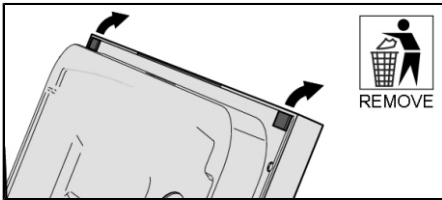

## Placing the dishwasher

The dishwasher can be installed under a worktop or freestanding. Make sure the area on which the dishwasher is to be installed is firm.

- When the dishwasher is installed with its worktop, the built-in measurements are shown in the illustration.

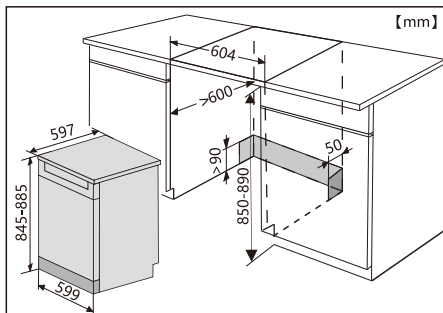

- When the dishwasher is installed in a recess without its worktop, the built-in measurements are shown in the illustration.

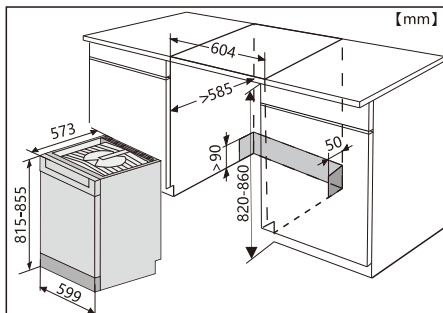

## Adjust the height and slide the dishwasher into place

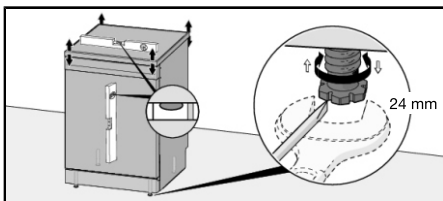

### Freestanding

- Make sure the area on which the dishwasher is to be installed is firm. Adjust the dishwasher's height using the four feet so that the dishwasher is level. The dishwasher may lean no more than 5 mm.

### Built-in

1. Start by measuring the height from the floor to the bottom edge of the worktop.
2. Measure the height from the floor to the top edge of the dishwasher.
3. Adjust the dishwasher's feet by turning them clockwise to raise or anticlockwise to lower the machine.
4. Check that there is an air gap of at least 3 mm between the underside of the worktop and the top edge of the dishwasher.

5. Slide the dishwasher into place.
  - Pull through the drainage and supply hoses when the machine is slid into place.
  - Check that the hoses have no kinks or sharp bends, and check that there is nothing that can damage the hoses.

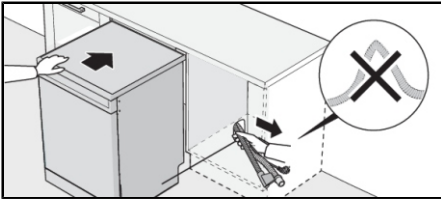

- Check that the machine is installed such that the door opens freely, otherwise door lock functionality may be disrupted.
6. Make any final adjustments to the front feet (the dishwasher may lean no more than 5 mm).

The dishwasher can also be installed in a recess without its worktop. See *Remove dishwasher worktop*.

## Drainage connection

This dishwasher is suitable for installing in a raised recess (to attain an ergonomic working height). This means that the dishwasher can be placed so that the drainage hose runs to a lower level than the bottom of the dishwasher, such as by routing it directly to a floor drain. The dishwasher is fitted with an integrated anti-siphon device to prevent the machine from being emptied of water during the wash cycle.

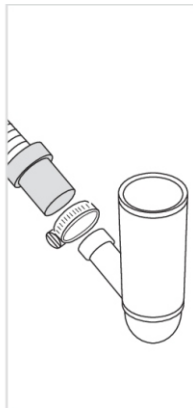
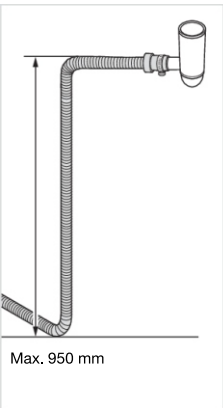
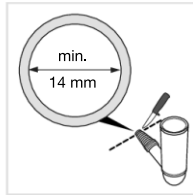
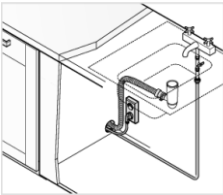

The drainage hose can also be connected to a connection nipple on the sink unit's water trap. The connection nipple must have an internal diameter of at least 14 mm.

The drainage hose may be extended by a maximum of 3 m (the total length of the drainage hose must not exceed 4,5 m). Any joins and connecting pipes must have an internal diameter of at least 14 mm. However, the drainage hose should ideally be replaced with a new hose without joins.

No part of the drainage hose may be more than 950 mm above the bottom of the dishwasher.

Attach the drainage hose with a hose clamp. Ensure that the drainage hose has no kinks.

## Connection to water supply

Use only the inlet hose supplied with the dishwasher. Do not re-use old or other spare hoses.

The supply pipe must be fitted with a water tap (stopcock). The water tap must be easily accessible, so that the water can be shut off if the dishwasher has to be moved.

Once the installation is complete, turn on the water tap and allow the pressure to settle for a while. Check that all connections are watertight.

## Connection to cold water supply

Connect the dishwasher to the cold water supply if the building is heated using oil, electricity or gas.

## Connection to hot water supply

Connect the dishwasher to the hot water supply (max. 60 °C) if the building is heated using an energy-efficient means such as district heating, solar power or geothermal power. Choosing a hot water connection reduces the dishwasher's energy consumption.

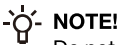

### NOTE!

Do not exceed the permitted water supply temperature. Certain materials used in some cookware cannot withstand high heat. See *Fragile dishes* in the chapter *Loading the dishwasher*.

## Electrical connection

Information about the electrical connection can be found on the serial number plate. This specification must match the electricity supply.

The dishwasher must be connected to an earthed socket.

The electric wall socket must be placed outside of the installation area to be easily accessible after installing the dishwasher. Do not use an extension cord!

## Remove dishwasher worktop

The dishwasher can be installed in a recess without its worktop. If the dishwasher's worktop is removed, the dishwasher must be installed under a separate worktop.

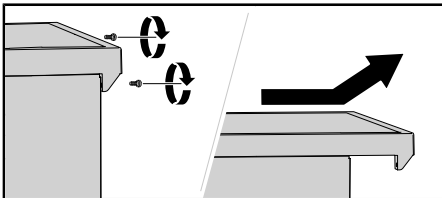

# Service

Read the chapter *Troubleshooting* before contacting the service centre. If you have encountered a problem that you cannot resolve, please contact your nearest service centre for professional help, see [www.hisense.com.au](http://www.hisense.com.au). Our website also has information about spare part availability and what you can repair yourself.

When making contact, provide the details on the serial number plate. Include the model number. Please note that non-professional repairs may risk user safety and affect the warranty.

# Technical data and energy labelling

## Information on energy label

Australian standard:	AS/NZS 2007
Number of place settings:	15
Dishwashing program:	Eco 45° <sup>1)</sup>
Program time:	4:16 hours:minutes
Connection:	Cold water 20 °C
Test method for noise measurement:	IEC 60704-2-3

<sup>1)</sup> The program Eco 45° is recommended for a normally soiled load equal to the rated capacity of the dishwasher.

## Technical data

Height:	845-885 mm
Width:	599 mm
Depth:	597 mm
Weight:	39 kg <sup>1)</sup>
Water pressure:	0.03-1.0 MPa
Rated voltage:	220-240 V~ 50 Hz
Rated power:	1900 W

<sup>1)</sup> Weight can vary due to different specifications.

## Information for consumers

Information about your product can be found at <https://hisense.com.au>. Please click on the magnifying glass icon and type the Model Number in the search bar.

## Test standard

Dishwasher tested in conformity with standard AS/NZS 2007.1 2005

Capacity: 15 place settings

Upper basket in lower position

Program: Eco 45°

Cutlery used: Alternative cutlery acc to GEMS Determination 2015, § 7 (3) (d), specified in schedule 1, part 4

1. Upper basket:

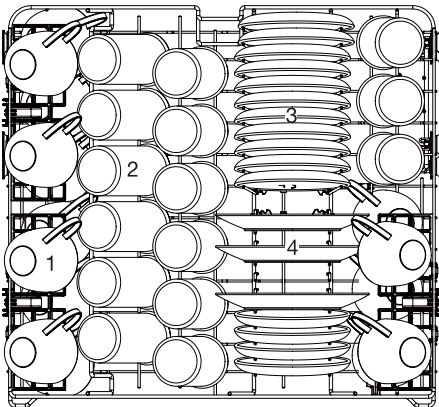

Number	Item
1	Cup
2	Glass
3	Saucer
4	Bread-and-butter plate

2. Lower basket:

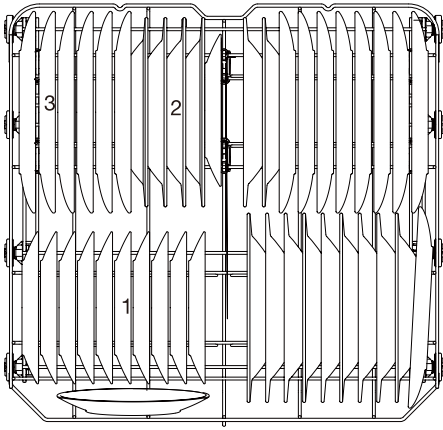

Number	Item
1	Bread-and-butter plate
2	Dinner plate
3	Soup(Dessert) plate

3. Top cutlery tray:

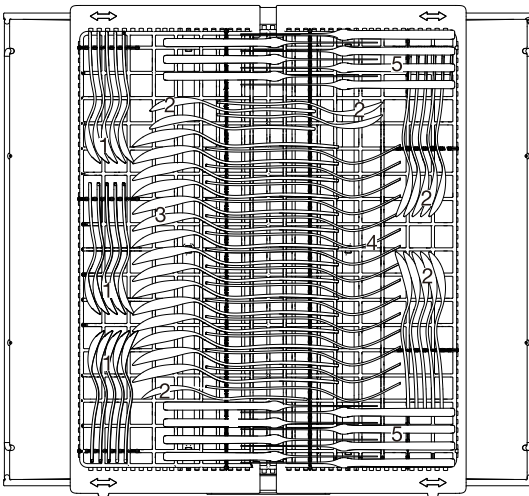

Number	Item
1	Tea spoon
2	Dessert spoon
3	Soup spoon
4	Fork
5	Knife

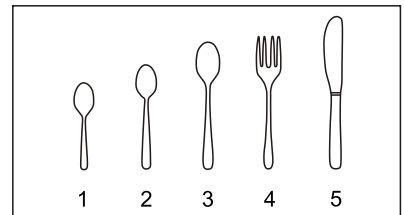

**Hisense**