

30DSERIES

turbofan[®]



G32D5

- Moisture Mode
- Multi-Stage Cooking
- Optional Core Temp Probe

Installation and Operation Manual

turbofan
CONVECTION OVEN SYSTEMS

MOFFAT

BLUE SEAL

MANUFACTURED BY

Moffat Limited

Christchurch
New Zealand

INTERNATIONAL CONTACTS

AUSTRALIA

Moffat Pty Limited

Web: www.moffat.com.au
E.Mail: vsales@moffat.com.au
Main Office: (tel) +61 (03) 9518 3888
(fax) +61 (03) 9518 3833
Service: (tel): 1800 622 216
Spares: (tel): 1800 337 963
Customer Service: (tel): 1800 335 315
(fax): 1800 350 281

CANADA

Serve Canada

Web: www.servecanada.com
E.Mail: info@servecanada.com
Sales: (tel): 800 551 8795 (Toll Free)
Service: (tel): 800 263 1455 (Toll Free)

NEW ZEALAND

Moffat Limited

Web: www.moffat.co.nz
E.Mail: sales@moffat.co.nz
Main Office: (tel): 0800 663328

UNITED KINGDOM

Blue Seal

Web: www.blue-seal.co.uk
E.Mail: sales@blue-seal.co.uk
Sales: (tel): +44 121 327 5575
(fax): +44 121 327 9711
Spares: (tel): +44 121 322 6640
(fax): +44 121 327 9201
Service: (tel): +44 121 322 6644
(fax): +44 121 327 6257

UNITED STATES

Moffat

Web: www.moffat.com
Sales: (tel): 800 551 8795 (Toll Free)
(tel): +1 336 661 1556
(fax): +1 336 661 9546
Service: (tel): 800 858 4477 (Toll Free)
(tel): +1 336 661 1556
(fax): +1 336 661 1660

REST OF WORLD

Moffat Limited

Web: www.moffat.co.nz
E.Mail: export@moffat.co.nz

The reproduction or copying of any part of this manual by any means whatsoever is strictly forbidden unless authorized previously in writing by the manufacturer.

In line with policy to continually develop and improve its products, Moffat Ltd. reserves the right to change the specifications and design without prior notice.

© Copyright Moffat Ltd. July 2014.

Contents List

G32D5 Turbofan Convection Oven.

Introduction.....	2
Safety Information	
Specifications.....	3
Oven Gas Supply Requirements and Specifications	
Installation	5
Installation Requirements	
Installation	
Unpacking	
Location	
Clearances	
Stand Mounted Ovens	
Electrical Connection	
Gas Connection	
Water Connection	
Recommended Water Specifications	
Positioning and Levelling of Oven	
Initial Start-Up	
Commissioning	
Operation	7
Operation Guide	
Cooking in Manual Mode	
Cooking in Manual Mode using Core Temp Probe	
Cooking in Program Mode	
Programming	14
Controller - Operator Settings.....	17
Changing Operator Settings	
Operator Settings	
Cleaning and Maintenance	18
Cleaning Guidelines	
Oven Cleaning	
Periodic Maintenance	
Fault Finding	21
Electrical Schematic.....	22
Gas Conversion and Specifications.....	23
Conversion Procedure	
Table of Gas Specifications	
Replacement Parts List.....	24
Appendix 1 - Oven Door Reversal.....	25

Introduction

Before using your new oven, please read this instruction manual carefully, pay particular attention to any information labelled **'WARNING'**, **'CAUTION'**, **'IMPORTANT'** or **'NOTE'** in this manual.



Warning

Indicates a hazardous situation which, if not avoided, will result in death or serious injury.



Caution

Indicates a hazardous situation which, if not avoided, will result in minor or moderate injury.

If you are unsure of any aspect of the installation, instructions or performance of your oven, contact your TURBOFAN dealer promptly. In many cases a phone call could answer your question.

Should you contact your TURBOFAN dealer on any matter concerning this oven, please have the information provided opposite, readily available.

For your safety, please pay attention to the following symbols marked on the appliance.

- Risk of electric shock.



- No user serviceable parts inside.
- Qualified service person access only.
- Disconnect from power before servicing.

This manual must be kept by the owner for future reference.

A record of the **Date of Purchase**, **Date of Installation** and **Serial Number of the oven** should be recorded in the area provided below.

The serial number of this oven can be found on the Technical Data Plate located on the front right hand side panel, see diagram in 'Installation Section'.

Model Number:

Serial Number:

Dealer:

Service Provider:

Date Purchased:

Date Installed:

Safety Information

Instructions to be followed in the event the user smells gas are to be posted in a prominent location. This information shall be obtained by consulting the local gas supplier.

FOR YOUR SAFETY

Do not store or use gasoline or other flammable vapours or liquids in the vicinity of this or any other appliance.



WARNING:

Improper installation, adjustment, alteration, service or maintenance can cause property damage, injury or death. Read the installation, operating and maintenance instructions thoroughly before installing or servicing this equipment.



Caution:

This appliance is;

- For professional use and is to be used by qualified persons only.
- Only qualified service persons are to carry out installation, servicing and gas conversion operations.
- Components having adjustments protected (e.g. paint sealed) by the manufacturer should not be adjusted by the user / operator.

MESURE DE SECURITÉ

Ne pas entreposer ni utiliser d'essence ni autres vapeurs ou liquides inflammables à proximité de cet appareil ou de tout autre appareil.



AVERTISSEMENT:

L'installation, le réglage, la modification, la réparation ou l'entretien incorrect de cet appareil peut causer des dommages matériels, des blessures ou la mort. Lire attentivement les instructions d'installation, de fonctionnement et d'entretien avant de procéder à son installation ou entretien.



Attention

Cet équipement est :

- Destiné à une utilisation dans un cadre professionnel et doit être utilisé uniquement par du personnel qualifié.
- L'installation, la maintenance et la conversion du type de gaz doivent obligatoirement être effectuées par des techniciens agréés.
- Les pièces dont les ajustements sont protégés (peinture) ne doivent pas être ajustées par l'opérateur / utilisateur.

Specifications

G32D5

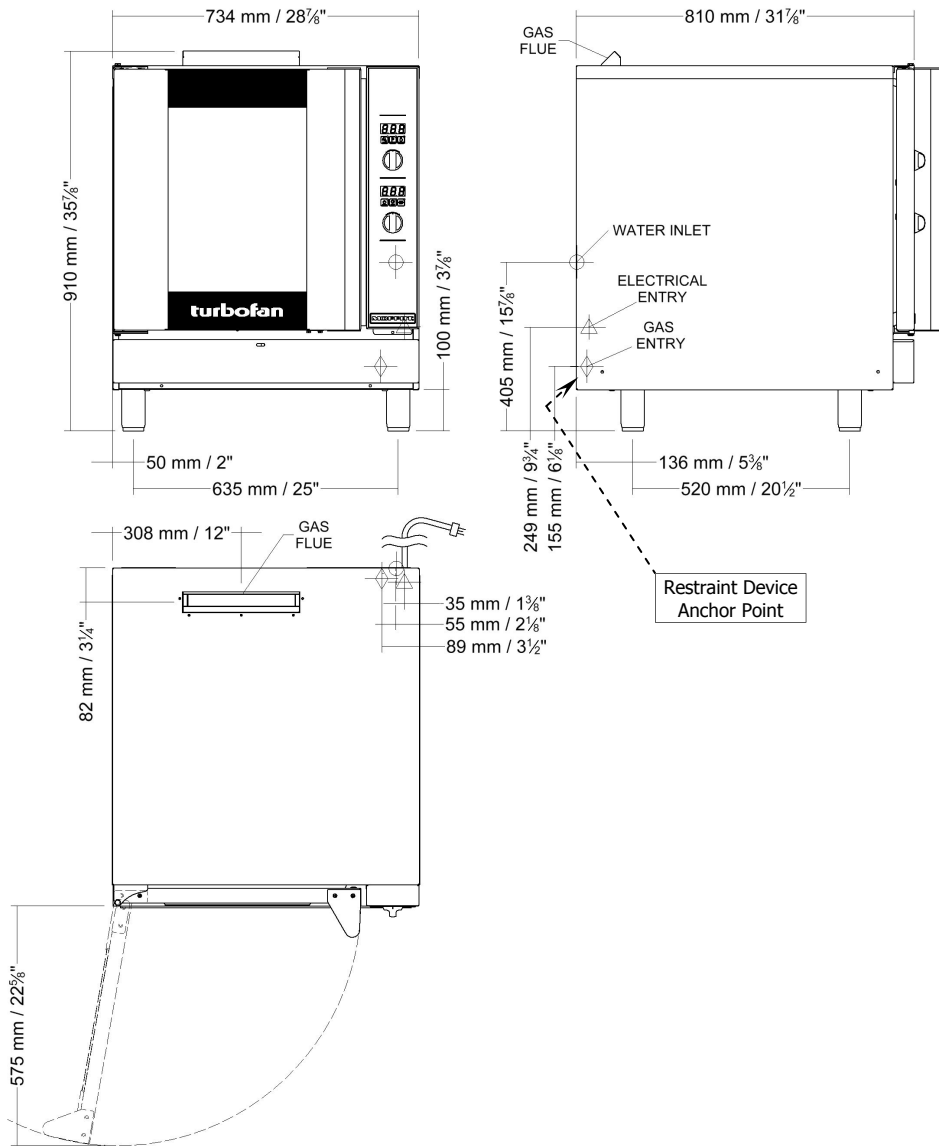

Oven Gas Supply Requirements and Specifications

	Natural Gas	LP Gas (Propane)
Input Rating	33,000 BTU/hr. (35 MJ/hr).	33,000 BTU/hr. (35 MJ/hr).
Supply Pressure	7" w.c. (1.75 kPa).	11" w.c. (2.75 kPa).
Operating Pressure	4.2" w.c. (1.05 kPa).	11" w.c. (2.75 kPa).
Gas Connection	1/2" NPT.	
Electrical Power Ratings	1 Phase, 110-120V, 60HZ, 220W.	
Oven Tray Details	Tray Capacity	5 x US Full Pan.
	Tray Spacing	85 mm / 3 1/3".
Water Connection	Max Water Pressure	80 psi / 550 kPa.
	Connection Size	3/4" BSP with 3/4" GHT Adaptor supplied.
NOTE: If Moisture Mode cooking option is not required, the oven does not need to be connected to a water supply.		

Installation

Installation Requirements

Important:

- Installation shall comply with local gas, electrical and health and safety requirements.
- It is most important that this oven is installed correctly and that oven operation is correct before use.
- If you have any questions regarding the proper installation and / or operation of this oven, please contact your local Turbofan distributor.

This installation of this appliance must conform with local codes, or in the absence of local codes, must conform to the National Codes shown below covering gas and electrical safety.

UNITED STATES: **ANSI 223.1 / NFPA 54 National Fuel Gas Code.**
ANSI / NFPA70 National Electrical Code.

CANADA: **CSA B149.1 National Gas and Propane Installation Code.**
CSA C22.2 Canadian Electrical Code.

Installation

Installations must be carried out by authorised persons only. Failure to install equipment to the relevant codes and manufacturers specifications shown above, will void the warranty.

NOTE:

- The oven and its individual shutoff valve must be disconnected from the gas supply piping system during any pressure testing of that system at test pressures in excess of 0.5psi (3.5 kPa).
- The oven must be isolated from the gas supply piping system by closing its individual manual shutoff valve during any pressure testing of the gas supply piping system at test pressures equal to or less than 0.5psi (3.5 kPa).

This oven must be electrically earthed / grounded in accordance with local codes.

Installation must allow for a sufficient flow of fresh air for the combustion air supply. Combustion air requirements:

Natural Gas 350ft³/hr (10m³/hr).

LPG 320ft³/hr (9m³/hr).

Components having adjustments protected (e.g. paint sealed) by manufacturer are only to be adjusted by an authorised service agent. They are not to be adjusted by the installation person.

Unpacking

1. Remove all packaging and transit protection including all protective plastic coating from exterior stainless steel panels.
2. Check the oven and supplied parts for damage. Report any damage immediately to the carrier and distributor.
3. Check that the following parts have been supplied with your oven:-
 - 4 x Leg Adjustable.
 - Brass Adaptor.
 - Rubber Washer. } USA / Canada only.
4. Report any deficiencies to the distributor who supplied your oven.
5. Securely fit the 4 legs supplied with the oven.
6. Check that the available gas and electrical supply is correct to that shown on the Technical Data Plate located on the front right hand side panel.
 - Refer to 'Specifications' section, 'Oven Specifications Tables'.

Location

1. This oven must be installed in an area of adequate air supply. Adequate ventilation is essential, to prevent dangerous build up of combustion products. DO NOT obstruct the air flow around the ventilation slots.
2. This oven must be fitted on supplied legs in all installations. (When installed on a manufacturers stand, the legs are used to locate the oven in the correct position.
3. All air for burner combustion is supplied from underneath the appliance. The legs must always be fitted and no obstructions placed on the underside or around the base of the appliance, as obstructions will cause incorrect operation and / or failure of the appliance.
4. Installation must allow for a sufficient flow of fresh air for the combustion air supply.
5. The area around the appliance must be kept free and clear from combustibles.
6. Position oven in its approximate working position. It should be positioned so that the control panel and oven shelves are easily reachable for loading and unloading.
7. Use a spirit level to ensure oven is level from side to side and front to back. (If this is not carried out, uneven cooking could occur).



Installation

Clearances

Important:

The vent located on the top of the oven must NOT be obstructed.

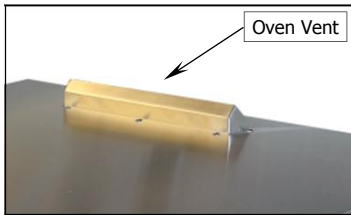

- To ensure correct ventilation for the motor and controller, the following minimum installation clearances are to be adhered to:-

	Combustible Surface	Non Combustible Surface
Top	600mm / 24"	200mm / 8"
LH / RH Side	75mm / 3"	75mm / 3"
Rear	75mm / 3"	75mm / 3"

CLEARANCE FROM SOURCE OF HEAT.

A minimum distance of 300mm (12") from the appliance sides is required.

NOTE: Fixed installations require at least 500mm (20") clearance at the right hand side of oven for service access.

Stand Mounted Ovens

For ovens that are to be mounted to a stand, the oven legs are used to level the oven on the stand. Refer to the instructions supplied with separately ordered stands for mounting details.

Electrical Connection



Warning

Electrical Grounding Instructions

This appliance is equipped with a three-prong (grounding) plug for your protection against shock hazard and should be plugged directly into a properly grounded three-pronged receptacle. **Do not cut or remove the grounding prong from this plug.**

Each oven should be connected to an adequately protected power supply and an isolation switch mounted adjacent to, but not behind the oven and must be readily accessible to the operator. This switch must be clearly marked and readily accessible in case of fire.

Check electricity supply is correct to as shown on Technical Data Plate on front right hand corner of oven side panel. Ensure oven is fitted with appropriate power cord and plug.

Gas Connection

Important:

For appliances installed on castors (double stacked, on base stand or on proofer), the installation shall be made with a connector that complies with:-

- ANSI Z21.69 • CSA 6.16 - Connectors for Moveable Gas Appliances.

and a Quick Disconnect Device that complies with:-

- ANSI Z21.41 • CSA 6.9, (2) - Quick Disconnect Devices for use with Gas Fuel.

Adequate means must be provided to limit the movement of the appliance without depending on the gas connector and the quick-disconnect device or its associated piping to limit the appliance movement.

The restraint anchor point is located below the gas connection point as shown.

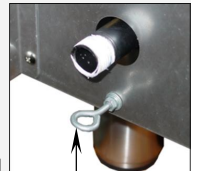

Restraining Anchor Point

A 1/2" N.P.T connection is provided at the bottom rear of the oven.

It is important that adequately sized piping run directly to the connection joint on the oven with as few tees and elbows as possible to give maximum supply volume.

A suitable jointing compound which resists the break down action of LPG must be used on every gas connection.

Check all gas connections for leakages using soapy water or other gas detecting equipment.



Warning

Do not use a naked flame to check for gas leakages.

Check the technical data plate located on the front right hand corner of the oven, for correct operating pressure and gas orifice size for the gas being used, before operation.

The appliance combination gas valve is fitted with an internal regulator for adjusting operating pressure. To access, remove appropriately marked service panel from beneath oven door. Unscrew and remove regulator cap from gas valve.

Adjust regulator to achieve stated pressure. Also refer to 'Specifications' section.

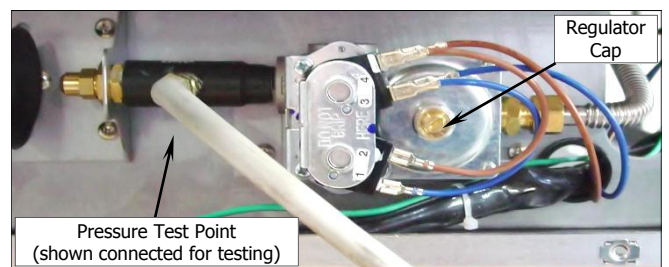

NOTE: The Pressure Test Point is located behind the front service panel beneath the oven door.

Installation

Water Connection

NOTE: If the Moisture Mode cooking option is not required, the oven does not need to be connected to a water supply.

1. Tighten the 2 screws securing the water connection to the rear of the oven. (These have purposely been left loose to prevent damage to the water connection during transit).
2. Connect a cold water supply to the water inlet (R 3/4" Connector) on the oven.



- Max Inlet Pressure 80psi / 550kPa.

3. Turn 'On' the water supply and check for leaks.

Recommended Water Specifications

In order to prevent corrosion or scaling in the oven and water system due to supplying water that is either too soft or too hard, the following recommendations should be used as a guideline.

Hardness: Between 60 and 90ppm.
PH: Greater than 7.5.
Chlorides: Less than 30 ppm.

Positioning and Levelling of Oven

1. Correctly locate the oven into its final operating position and using a spirit level, adjust the oven feet so that the oven is level and at the correct height.

Initial Start-Up

Before using the new oven;

1. For first time use of the oven, operate the oven for about 1 hour at 200°C / 400°F to remove any fumes or odours which may be present.
2. Refer to the Operation Section of this manual for details on how to correctly operate and shutdown the oven.

Commissioning

Before leaving the new installation;

1. Check the oven functions in accordance with the operating instructions specified in the 'Operation' section of this manual.
2. Ensure that the operator has been instructed in the areas of correct lighting, operation, and shutdown procedure for the appliance.

NOTE: If for some reason it is not possible to get the appliance to operate correctly, shut off the gas supply and contact the supplier of this appliance.

Operation

Operation Guide



Warning

Some parts of this oven will become **VERY HOT** during use and could cause burns if touched.



Warning

Take care when opening the oven door during baking. Let hot air and steam escape before removing or replacing food as the steam produced can cause steam burns.

- This oven is intended for use in a commercial kitchen and must only be put to the use for which it was intended, i.e. cooking food product. To use this oven correctly please read the following sections carefully:-



Temperature Display -

Shows pre-set chamber temperature. When used with the 'Temp' key, display shows actual oven temperature for 5 seconds. Shows cooking programs and error codes.



'Steam' Key and LED -

Used to set moisture level or to provide a manual injection of moisture when in Manual Moisture Mode. LED is 'On' when automatic moisture injection is set or when moisture is manually injected.

Temperature Adjustment Control



Time Display -

Shows cook time in full minutes only from 180 - 10, and in minutes and seconds for the final 10 minutes.

NOTE:

In Core Temp Mode, time display alternates between 'CP' and set core probe temperature.



'On/Off' Key and LED -

Press 'On/Off' key once to turn the oven 'On'. Press and hold 'On/Off' key for 1.5 seconds to turn the oven 'Off'.

Time Adjustment Control

NOTE:

In Core Temp Mode, 'Timer' knob is used to set core probe temperature.

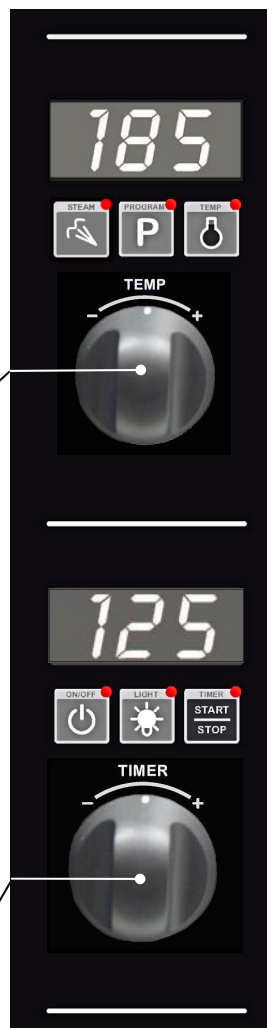

'Program' Key and LED -

Used to select cooking programs and to set program operator settings.



'Temp' Key and LED -

Displays actual oven temperature for 5 seconds on Temperature Display. LED 'On' when heating element is on (heating indicator).

LED flashes when Upper Display is showing actual temperature.

NOTE:

In Core Temp Mode, this key is used to display Actual Oven Temperature (Upper Display) and Core Probe Temperature (Lower Display).



'Light' Key and LED -

Switches oven lights 'On/Off'. LED is 'On' when oven lights are 'On'.



'Timer-Start/Stop' Key & LED -

The 'Timer-Start/Stop' key is used to control the following functions:-

- Cancelling Alarm (All Modes).
- Starting Core Temp Mode (Core Temp Mode).
- Starting Timer (Manual Mode).
- Pausing (Manual / Program Modes).
- Re-setting Timer (Manual Mode).
- Starting Program (Program Mode).
- Cancelling and Re-setting Program (Program Mode).

Core Probe Connection Point

Operation

Manual Mode

In Manual mode the ovens settings are.

- Temperature - 50-250C / 150-550F.
- Timer setting - 0-180min or Infinite.
- Fan Speed setting - Hi / Lo.
- Moisture Mode settings - Off / On-Level.
- Oven lights - Off / On.

An Optional Core Probe can also be used in Manual Mode.

Program Mode

In Program Mode 20 Programs are able to be used.

In each program the following settings are possible.

- Temperature - 50-250C / 150-550F.
- Time - 0-180min or Infinite.
- Fan Speed - Hi/ Lo.
- Moisture Mode - Off / On-level.

3 cooking stages can also be set in each of the 20 programs.

- All settings can be changed between cooking stages.
- At completion of each stage an end of stage alarm can also be set.

Optional Core Probe can also be used in Program Mode.

Changing between Manual to Program Modes



Press 'Program' key to select Program Mode. The LED will illuminate showing Program Mode now set. Press 'Program' Key to return to Manual mode.

Moisture Mode

There are 6 levels of pre-set moisture injection.

Each level defines the number of moisture injection pulses per moisture cycle during oven operation.

- H-0** Manual Moisture Mode. Automatic Moisture Injection is 'Off'. Pressing 'Steam' key in this mode will inject 1 shot of steam into the oven, ie, no steam injection without user input.
- H-1** Level 1. - Minimum automatic moisture injection setting. One moisture pulse per moisture cycle.
- H-2** Level 2.
- H-3** Level 3.
- H-4** Level 4.
- H-5** Level 5. - Maximum automatic moisture injection setting. Five moisture pulses per moisture cycle.

Selecting Moisture Mode



Press 'Steam' key to activate Moisture Mode. 'Steam' key LED will illuminate when Moisture Mode is 'On'. Moisture Mode will operate at the preset level during the cooking cycle.

- When Moisture Mode H-0 is selected, a shot of steam is available whenever the oven is running, by pressing the 'Steam' key.
- When Moisture Mode H-1 to H-5 are selected, these moisture modes will only operate when a program is running, Core Temp Probe Mode has been selected or when a timer is running in Manual Mode.
- When setting Moisture level, consider the Oven Set Temperature. If set BELOW 100°C (212°F), water may pool in oven as temperature will be too low to create steam.

Changing Moisture Mode Level



Press and hold the 'Steam' Key until the 'H-X' level is displayed and flashing in the upper display. Rotate the 'Temp' Knob +/- to select Moisture Mode level required. Press the **STEAM** Key to confirm setting.

The 'Moisture' Mode level can be changed at anytime during operation by following the setting method as described above.

Core Temp Cooking Mode - Optional

An Optional Core Temp Probe Kit #236060 is available for this oven.

This allows use of the Core Probe Cooking feature of this oven. When the core probe is fitted to the connection point on control panel side, the timer function and display becomes the core temp probe temperature setting and display. Cooking completion is then determined by the core temp probe reaching the set core probe temperature.

To enable Core Probe Cooking Mode plug in the Core Probe. The Timer Display will then change to 'CP' (Core Probe). The Timer Knob function will then be for Core Temp setting. To disable Core Probe Cooking Mode, unplug the Core Probe. The Timer Display and Knob will return to time function.

Operation

Cooking in Manual Mode

On oven start-up the controller defaults to the following settings:-

Oven Temperature is set to 150°C (302°F). Refer 'Controller - Operator Settings' section to change this start-up temperature.

Oven Timer is not set, display shows '- - -'.

Moisture Setting is setting to Manual Injection.

1. SET OVEN TEMPERATURE.



Rotate 'Temp' knob to select temperature required.

+ to increase the temperature (Max. 260°C / 500°F).

- to decrease the temperature (Min. 60°C / 140°F).

The oven will commence heating to the displayed set temperature.

NOTE: The oven can be used without using the timer.

2. SET TIMER.



Rotate 'Timer' knob to select time required.

+ to increase the time (Max. 180 minutes).

- to decrease the time (Min. 1 minute).

NOTE: Timer can be set to 'Infinity' **Inf**. If timer is set to 'Infinity', timer will count elapsed time to a max of 999 minutes and elapsed time will be shown on the Lower Display.

3. SET MOISTURE MODE.



Press and hold 'Steam' key for 3 seconds.

Rotate 'Temp' knob to select desired moisture level (H-0 to H-5).

Press 'Steam' key to confirm settings.

NOTE: Refer to 'Moisture Mode Settings' at start of this section for additional explanation of moisture level adjustments.

4. STARTING TIMER.



Press 'Timer-Start/Stop' key to start timer operation. LED will illuminate to indicate the timer is running.

Pressing 'Timer-Start/Stop' key or opening oven door when timer is operating will pause timer and turn 'Off' fan and heating. Timer LED will flash.

Press and hold 'Timer-Start/Stop' key for 3 seconds to cancel timer.

5. CANCELLING 'TIME UP' ALARM (COOKING TIME COMPLETED).

When the set Cooking Time is completed, alarm will sound and Lower Display flashes.



- Press 'Timer-Start/Stop' key to cancel alarm, oven will continue cooking at Oven Set Temperature. Display will revert to Set Temperature and Time.

- Alternatively, open oven door to cancel alarm and turn 'Off' fan and heating. Close oven door to resume cooking at Oven Set Temperature. Display will revert to Set Temperature and Time.

NOTE: Any of the above settings can be adjusted during the cooking operation by using the above controls and keys.



• **Viewing Actual Oven Temperature.** Press 'Temp' key during cooking, Oven Actual Temperature will display on Upper Display for 5 seconds and then will revert to displaying Oven Set Temperature.



Operation

Cooking in Manual Mode using Core Temp Probe (Requires Optional Core Temp Probe Kit #236060).

On oven start-up the controller defaults to the following settings:-

Oven Temperature is set to 150°C (302°F). Refer 'Controller - Operator Settings' section to change this start-up temperature.

Oven Timer is not set, display shows '---'.

Moisture Setting is setting to Manual Injection.

1. CONNECT CORE TEMP PROBE.

Connect Core Temp Probe to connector on lower right side of control panel, **CP** will be displayed on Lower Display.

2. SET OVEN TEMPERATURE.



Rotate 'Temp' knob to select temperature required.
+ to increase the temperature (Max. 260°C / 500°F).
- to decrease the temperature (Min. 60°C / 140°F).

The oven will commence heating to the displayed set temperature.

3. SET CORE PROBE TEMPERATURE.



Rotate Timer Knob to set the desired core probe temperature.
+ to increase temperature (Max. 90°C / 194°F).
- to decrease temperature (Min. 50°C / 122°F).

Once Core Probe Set Temperature is set, Lower Display will alternately flash between **CP** and Core Probe Set Temperature.

'Timer-Start/Stop' LED is 'Off', indicating that cooking has not yet started.

4. SET MOISTURE MODE.



Press and hold 'Steam' key for 3 seconds.
Rotate 'Temp' knob to select desired moisture level (H-0 to H-5).
Press 'Steam' key to confirm settings.

NOTE: Refer to 'Moisture Mode Settings' at start of this section for additional explanation of moisture level adjustments.

5. START CORE TEMP MODE COOKING.



Press 'Timer-Start/Stop' key to start Core Temp Mode cooking. 'Timer-Start/Stop' LED is 'On' during Core Temp Mode cooking. Lower Display will alternately flash between **CP** and Core Probe Set Temperature during cooking.

6. CANCELLING CORE TEMP ALARM (CORE TEMP SETTING REACHED - COOKING COMPLETE).

When Core Probe Set Temperature is reached, an alarm will sound and the Lower Display will flash.



- Press 'Timer-Start/Stop' key to cancel alarm, oven will continue cooking at Oven Set Temperature. Display will show Oven Set Temperature and Core Probe Set Temperature.

- Alternatively, open oven door to cancel alarm and turn 'Off' fan and heating. Close oven door to resume cooking at Oven Set Temperature. The display will revert to the Oven and Core Probe Set Temperatures.

NOTE: Any of the above settings can be adjusted during cooking operation by using the above controls and keys.



- **Viewing Actual Oven and Core Temperatures.** During cooking, press 'Temp' key to check Oven Actual Temperature (Upper Display) and Core Probe Actual Temperature (Lower Display). Actual temperatures will display for 5 seconds before display reverts to show Oven Set Temperature (Upper Display) and Core Probe Set Temp (Lower Display).
- **Exiting Core Temp Cooking Mode.** Disconnect Core Probe from connector on lower right side of control panel. Lower Display and 'Timer' knob will revert to normal Timer Mode operation.



In Core Temp Mode, pressing 'Temp' key will also display Core Probe Actual Temperature on Lower Display.

In Core Temp Mode, the Lower Display will alternate between 'CP' and the Core Probe Set Temperature.

'Timer-Start/Stop' LED is 'On' when Cook Mode in Progress.

In Core Temp Mode, the 'Timer' knob is used to set Core Probe Temperature.

Operation

Cooking in Program Mode

The oven can be pre-programmed with up to 20 Programs; each program can contain a maximum of 3 stages. When you receive your oven, the controller is not pre-programmed.

1. SELECTING A PROGRAM.



Press 'Program' key.

Upper Display will show program number selected.



+ to scroll forward through programs.
- to scroll backward through programs.

Lower Display will show **P-H**, oven is 'Pre-Heating'.
Program cannot be started until pre-heating is completed.

2. OVEN READY.

Lower Display will show **rdy** when oven is up to pre-heat temperature and an alarm will sound.

Load product into oven.

3. CONNECT CORE TEMP PROBE (IF REQUIRED).

Connect Core Temp Probe to connector on lower right side of control panel, **CP** will be displayed on Lower Display.

NOTE: A Core Temp Probe can be used as part of a multi-stage cooking program. If a program reaches a Stage that requires a Core Temp Probe and no Core Temp Probe is connected, an error alarm will sound and 'CP' will flash on Lower Display. The program is automatically paused until the Core Temp Probe is connected. Once the probe is connected to the control panel and inserted into the food product, press the 'Timer-Start/Stop' key to resume the program.

4. START PROGRAM.



Press 'Timer-Start/Stop' key to start cooking program.

- Pressing 'Timer-Start/Stop' key when timer is operating, will pause timer and turn 'Off' Fan and Heating. LED will flash when timer is paused.
- Pressing and holding 'Timer-Start/Stop' key for 3 seconds will cancel the program and return to the Preset Program.

During Program Operation the Upper and Lower Displays will show the following:-

- Upper Display shows Program Number, e.g. **P01**
- Lower Display will show either,
 - Total Time Remaining in Program.OR
 - Total Elapsed Time of Program (if any Program Stages are set to CP or InF).OR
 - Alternate between 'CP' and Core Probe Set Temp (if presently in a Core Probe Stage).

5. CANCELLING PROGRAM 'TIME UP' ALARM (COOKING TIME COMPLETED).

When program is completed, the alarm will sound.



- To cancel alarm, press 'Timer-Start/Stop', oven will continue to cook at Oven Set Temperature. Display will revert to Program Number (Upper Display) and Total Program Time (Lower Display).
- Alternatively, open oven door to cancel alarm and turn 'Off' fan and heating. Close oven door to resume cooking at Oven Set Temperature. Display will revert to Program Number (Upper Display) and Total Program Time remaining (Lower Display).



'Program' LED is 'On' when Oven operating in Programs Mode.

'Light' LED is 'On' when oven lights are 'On'.

Operation

ADDITIONAL ADJUSTMENTS (These can be adjusted whilst Program Mode is Running).

NOTE: Adjustments made during cooking will not be saved to the program.

A. VIEWING STAGE NUMBER AND STAGE TIME REMAINING.

To view the Program and Stage numbers on the Upper Display, e.g. 3.1 = Program 3, Stage 1, and the Total Time Remaining in Stage remaining on the Lower Display:

- Press 'P' key during Program Cooking.

OR

- Turn Timer knob in either direction.

- Upper Display will show Program and Stage, e.g. **3.1**

- Lower Display will show either,
 - Total Time Remaining in Stage.

OR

- Total Elapsed Time of Stage (if Stage is set to 'InF').

OR

- Core Probe Set Temp (if Stage is set to 'CP').

OR

- Alternate between 'CP' and Core Probe Set Temp (if presently in a Core Probe Stage).

Display will revert back to Overall Display after 5 seconds.

B. USING 'TEMP' KNOB DURING PROGRAM COOKING.

• VIEWING SET TEMPERATURE



Turn 'Temp' knob (in either direction) to display Set Temperature of Current Stage on Upper Display. Display will revert back to Overall Display after a 5-second delay.

• ADJUSTING SET TEMPERATURE



Hold 'Temp' knob in either direction for 3 seconds will enter 'Temp Edit Mode' where 'Temp' knob can be used to temporarily adjust temperature for the current stage. Controller will update the Temperature and exit 'Temp Edit Mode' after a 5-second delay.



Here Oven Set Temperature has been increased from 150 to 175°C (325 to 350°F).

C. USING 'TIMER' KNOB DURING PROGRAM COOKING.

• VIEWING STAGE NUMBER AND REMAINING TIME



Turn 'Timer' knob (in either direction) to switch the display from Overall (Program, Total Time remaining) to Current Stage-in-Progress (Stage, Stage Time Remaining). Display will revert to Overall display after a 5-second delay.

• ADJUSTING REMAINING TIME / ADJUSTING CORE PROBE SET TEMP



Hold the 'Timer' knob in either direction for 3 seconds to enter 'Timer Edit Mode' where 'Timer' knob can be used for temporary adjustment of either:

- Core Probe Set Temperature.

OR

- Stage Time remaining.

The controller will update the value and exit 'Timer Edit Mode' after a 5-second delay.

Time remaining can be adjusted between 0-180 minutes, but cannot be set to 'InF' or 'CP'.

Core Probe Set Temp can be set between 50-90°C (122-194°F).



Here Core Probe Temperature has been increased from 54 to 75°C (129 - 167°F).

NOTE: Any changes will only apply to the current stage. Any following stages will revert to the programmed settings.

Operation

D. CHANGING THE MOISTURE SETTING.



Press and hold 'Steam' key for 3 seconds.
Rotate 'Temp' knob to select desired moisture level (H-0 to H-5).
Press 'Steam' key to confirm settings.

NOTE: Refer to 'Moisture Mode Settings' at start of this section for additional explanation of moisture level adjustments.

E. VIEWING ACTUAL OVEN TEMPERATURE / ACTUAL CORE PROBE TEMPERATURE.



Press 'Temp' key during cooking. Oven Set Temperature will display on Upper Display for 2 seconds, then Actual Temperature will display on Upper Display for 2 seconds. At the same time, Actual Core Probe temperature will display on Lower Display for 4 seconds. After 4 seconds, controller will revert to displaying the program number.

F. ADDING MORE TIME TO A STAGE WHEN THE END OF STAGE ALARM IS SOUNDING.

At the end of a stage, provided that 'ALr'=On, an end of stage alarm will sound for 1 minute before automatically progressing on to the next stage of the program. While alarm is sounding, additional cooking time can be added to the stage that has just finished.



Rotate and hold 'Timer' knob for 3 seconds to enter Timer Edit Mode and add time to the stage.
When the length of time required has been added, either;



- Press 'Timer-Start/Stop' key to resume the stage,

OR

- Wait for the auto-resume feature to progress the oven on to the next stage, 1 minute after alarm initially sounded.



When the additional time has run out, the end of stage alarm will sound for a second time. Either press 'Timer-Start/Stop' key to progress on to the next stage, or let the program automatically progress on to the next stage after 1 minute of inactivity.

G. TURNING THE LIGHTS 'ON/OFF'.



Whenever the oven is 'On' the 'Light' key is used to turn the oven lights 'On/Off'. To extend bulb life, an auto time-out can be pre-set to switch oven lights 'Off' after a set length of time. The factory default for time-out is 'Off' ('0', ie lights remain 'On' until light key is pressed again). This time-out can be activated by setting the operator settings L-0 from 1-60 minutes.

NOTE: Any changes will only apply to the current stage. Following stages will revert to the programmed settings.

Programming

Programming

The oven can be pre-programmed with up to 20 Programs; each program can contain a maximum of 3 stages. When you receive your oven, the controller is not pre-programmed. To set programs, carry out the following for each program required:



1. SELECT PROGRAMS MODE.

 Press 'Program' key to enter Programs Mode. 'Program' LED will illuminate.

2. SELECT PROGRAM REQUIRED (P01 - P20).

Rotate 'Temp' knob to the program required. Upper Display will show program selected.

3. ENTER PROGRAMMING MODE.

 Press and hold 'Program' key until a beep is heard, indicating entry into Programming Mode. Upper Display shows program and stage numbers eg. = Program 3, Stage 1. 

'Program' LED will flash whilst in Programming Mode.

4. SELECT STAGE TO PROGRAM.

NOTE: If Multi-Stage Cooking is disabled, (Parameter 'StG' - refer to section 'Controller Operator Settings') skip to Step 6 to continue programming otherwise continue as below and overleaf.

All active stages and the first inactive stage are visible and can be accessed by rotating the 'Temp' knob to scroll through the stages. When editing a program for the first time, only the first stage will be visible and it will be 'Off' by default. Setting parameters for a stage changes its state from 'Off' to 'On' (activates the stage).

- **To Turn a Stage 'On'.**
Either - Rotate 'Timer' knob clockwise to select 'On'.
Or - Press 'P' key and program stage settings.
 (Setting parameters for a stage automatically changes its state to 'On').
- **To Turn a Stage 'Off'.**
 Rotate 'Timer' knob anti-clockwise to select 'Off'.

NOTE: Only the last active ('On') stage can be turned 'Off'.

Rotate 'Temp' knob:-

- '+' to advance one stage.
- '-' to go to the previous stage.

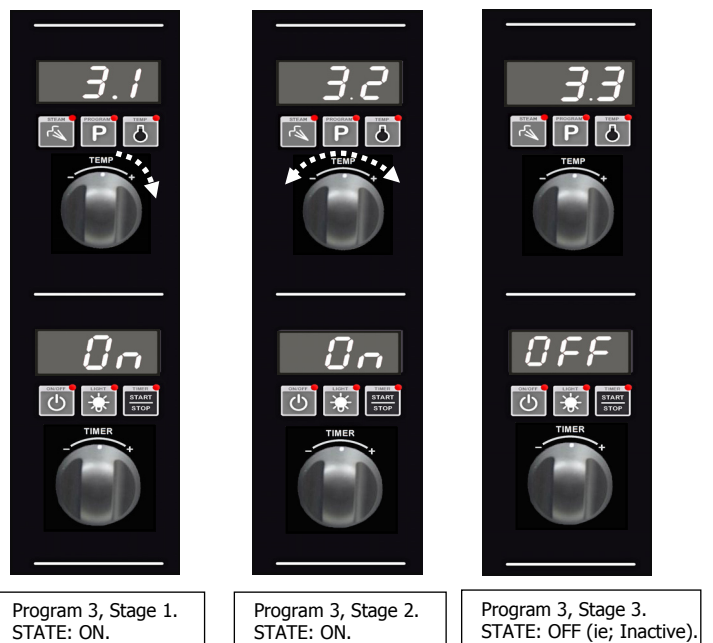
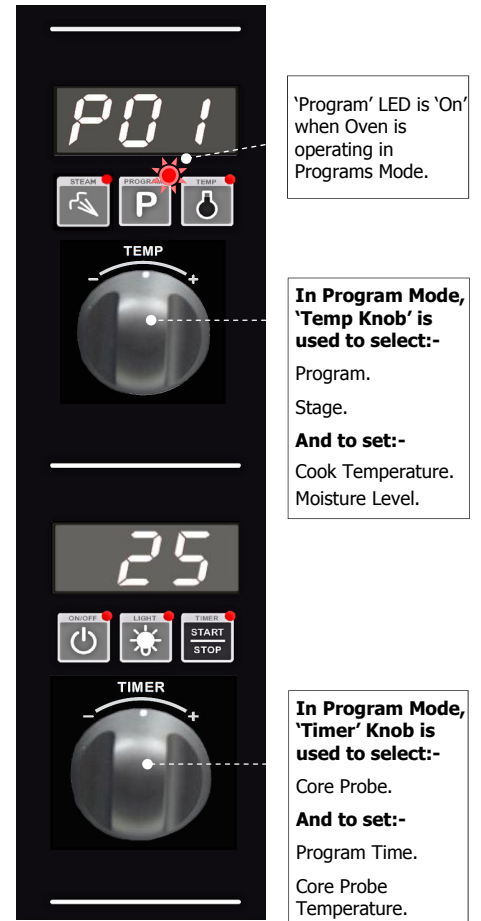

Program 3, Stage 1.
STATE: ON.

Program 3, Stage 2.
STATE: ON.

Program 3, Stage 3.
STATE: OFF (ie; Inactive).

Programming

5. CONFIRM STAGE TO EDIT.



Press 'Program' key to begin editing a program and stage displayed on the Upper Display.

6. SET OVEN TEMPERATURE.

Upper Display flashing

Rotate 'Temp' knob to select temperature required.

- + to increase the temperature (Max. 260°C / 500°F).
- to decrease the temperature (Min. 60°C / 140°F).

Press 'P' key to confirm temperature setting. Controller will step to Cook Time / Core Temp Probe setting.

7. SET COOK TIME / CORE TEMP PROBE.

Lower Display flashing

The 'Timer' knob can be used to select Core Temp Probe or a Cook Time option.



Turn and Release Timer Knob to change selection.

Hold Knob to Fast Forward Fast Reverse.

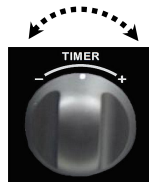

- = Stage has been set to 'OFF'.
- InF = Infinity Time Setting.
- CP = Core Temp Probe (optional extra).
- Time = From 1 minute to 180 minutes.

- **By setting a Cook Time**, the stage will be governed by Oven Temperature, Timer, Moisture setting.

Rotate 'Timer' knob to select time required.

- + to increase Cook Time (Max. 180 minutes).
- to decrease Cook Time (Min. 1 minute).

Press 'P' key to confirm Timer setting and advance to setting Moisture setting.

- **By setting Core Temp Probe (CP)**, the stage will run at a set Oven Temperature, Moisture Mode until the actual core temperature reaches the pre-set core probe temperature value. Refer to the 'Cooking in Manual Mode with Core Probe' Section for instructions on cooking with the Core Probe fitted. Turn and hold timer knob until lower display shows 'CP'. Controller will step to setting Core Probe Temperature. Core Probe Temperature value is displayed on Lower Display.

Rotate 'Timer' knob to select temperature required.

- '+' to increase Core Probe Temperature (Max 90°C / 194°F).
- '-' to decrease Core Probe Temperature. (Min 50°C / 122°F).

Press 'P' key to confirm Core Probe Temp Setting. Controller will step to Moisture setting.

- **By setting Infinite Time setting ('InF')**, Oven counts time upwards up to a limit of 999 minutes. The Infinite ('InF') timer option is only available as an option when setting the last stage of a program. If the 'InF' timer option is programmed, no stages after the 'InF' stage will be available / visible. Turn 'Off' all stages that come after a given stage in order to set an 'InF' timer for that stage.

Press 'P' key to confirm infinite time 'InF' setting and advance to setting Moisture setting.

Programming

8. SET MOISTURE OPTION (H-0 - H-5).

Upper Display flashing

Rotate 'Temp' knob to select Moisture setting required.

'+' to increase moisture setting.

'-' to decrease moisture setting.

(Refer to Operation section, 'Moisture Mode Settings', for additional explanation of moisture level adjustment).

Press 'P' key to confirm Moisture setting. Controller will step to Alarm for End of Stage setting.

NOTE: If Multi-Stage Cooking is disabled, (Operator setting 'StG' - set to 'no'), the controller will exit the Programming Mode after the 'P' key is pressed to confirm moisture setting.

9. SET ALARM FOR END OF STAGE ('ON-OFF').

Upper Display shows

Lower Display flashing with current alarm setting

Rotate 'Timer' knob to select desired alarm state which will be shown on the Lower Display.

'ON' - Alarm sounds at completion of the cooking stage, the program is paused awaiting user action. Without any input, the program will automatically resume after 1 minute.

- Press 'Timer-Start/Stop' key to stop the alarm, resume cooking and to continue to the next cooking stage.

OR

- Open oven door to stop alarm. Close door and press 'Timer-Start/Stop' key to continue cooking and to continue on to the next cooking stage.

'OFF' - Oven continues on to the next cooking stage without sounding an alarm.

NOTE: Regardless of the setting applied to the last stage of the program, a Cook Time Completed Alarm will sound to indicate the end of the program.

Press 'P' key to confirm alarm option. Alarm will sound to confirm that all stage parameters have been set.

Repeat Step 1 to Step 9 to program additional stages.

10. EXIT PROGRAMMING MODE.

Press and hold 'P' key for 3 seconds until alarm sounds to exit the Programming Mode.

Controller - Operator Settings

Changing Operator Settings

With the Oven in 'Stand-By' Mode (i.e. Power to oven but both displays are blank).

1. ENTERING THE OPERATOR SETTING MODE.



Press and hold 'Steam' and 'Timer-Start/Stop' keys together for 3 seconds.

Upper Display will show **PAS**.

Lower Display will flash **000**.

2. SETTING PASSWORD (OPERATOR PASSWORD - 123).

Rotate 'Timer' knob to set password **123**.



Press 'Light' key to confirm password.

Upper Display will show one of the setting codes, eg. **P-H**

Lower Display will show the value of the setting, eg. **185**

3. CHANGING THE SETTINGS.

Rotate 'Timer' knob to the setting required.



Press 'Light' key to confirm setting required. Lower Display will flash.

While Lower Display is flashing, rotate 'Timer' knob to select value required.



Press 'Light' key to confirm value. Lower Display will stop flashing.

4. EXITING THE OPERATOR SETTING MODE.



Press 'On-Off' key, to exit the Operator Settings Mode and to return to Stand-By Mode.



Operator Settings

Setting Number	Description	Setting Range	Default Setting
P-H	Oven Pre-Heat; - (Automatic Pre-Heat Temp on oven start-up).	60 - 260°C 140 - 500°F.	150°C (302°F)
L-0	Light Auto 'Off' Setting Time - 0 = 'On/Off'. 1 = 1 minute auto 'Off'. 2 = 2 minutes auto 'Off', etc.	0 - 60 mins.	0
uol	Alarm Volume - Can be adjusted to suit operators preference.	0 - 10.	5
P-r-E	Program Pre-Heating Condition - This setting allows for pre-heating 'Ready' temperature in 'Program Mode' Mode to be set higher than Program Set Temperature. Factory Default Setting is '0' (Equal to Program Setting).	0 - 30°C 0 - 54°F.	0
StG	Multi-Stage Enable - This setting enables multi-stage programming. Factory Default Setting is 'YES', multi-stage programming is enabled. Changing this setting this to 'no' simplifies programming and program cooking.	'YES' or 'no'.	YES

Cleaning and Maintenance

Cleaning Guidelines



Caution

Always turn off electrical power at the mains supply before commencing cleaning.

This oven is not water proof. Do not use water jet spray to clean interior or exterior of the appliance.

NOTE:

- If this appliance is fitted with a Restraint Device, the device must be dis-connected prior to moving the appliance for cleaning. Always ensure that the restraining device is re-connected on completion of the cleaning operation.

To achieve the best results, cleaning must be regular and thorough. If any small faults occur, have them looked at promptly. Don't wait until they cause a complete breakdown.

NOTE:

- Carefully read and follow the safety instructions on the label of the cleaning product to be used.
- DO NOT use harsh abrasive scouring pads or abrasive detergents as they could damage the oven.
- Ensure that any detergent or cleaning material has been completely removed after each cleaning.

To keep your oven clean and operating at peak efficiency, follow the procedures shown below:-

Oven Cleaning

NOTE:

- If oven usage is very high, the cleaning procedure should be carried out on a more frequent basis.
- Allow the oven interior to cool to approx 50°C / 120°F before commencing cleaning.

Stainless Steel Surfaces

- Thoroughly clean exterior surfaces of oven with, a damp cloth moistened with a mild detergent solution, or a soft bristled brush.
- Baked on deposits or discolouration may require a good quality stainless steel cleaner. Always apply cleaner when oven is cold and rub in direction of grain.

Side Racks Removal

Right Rack / Fan Baffle

- Undo and remove rack securing screw securing front of RH side rack. The fan baffle is an integral part of RH Side Rack.

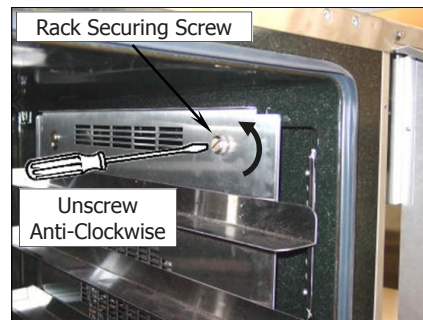

- Lift up and unhook the rear of the rack from the locating peg at the rear of the oven.

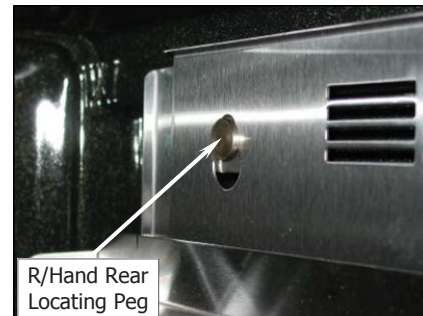

- Tilt the top of the rack inwards and lift the rack off the lower mounting brackets.

Left Rack

- Lift the LH rack off the front locating peg.

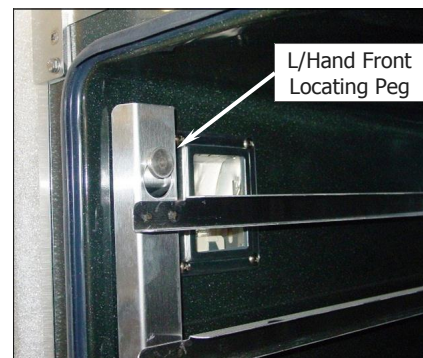

- Pull the rack forward out of the oven to disengage the rear of the rack from the rear location peg and remove the rack from the oven.



- Clean the racks with a mild anti bacterial detergent and hot water, using a soft bristled brush.
- Dry the racks thoroughly with a dry cloth.

Cleaning and Maintenance

Side Racks Re-Fitting

Right Rack

- Align the bottom of the rack with the 2 brackets in the bottom RH side of the oven.

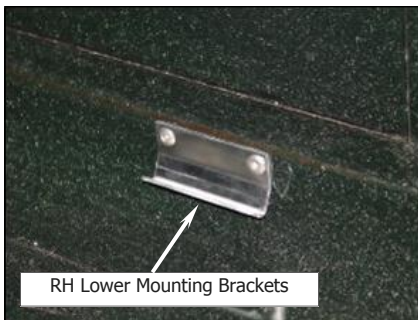

- Tilt the rack upwards and hook the top rear of the rack on to the locating peg in the top rear of the oven.

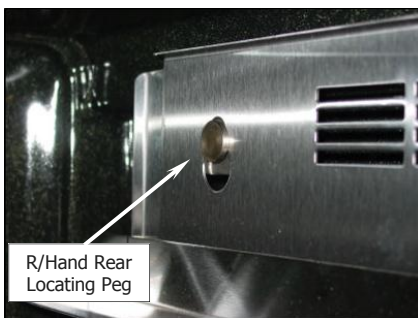

- Fit and tighten the rack securing screw to secure the front of the RH rack.

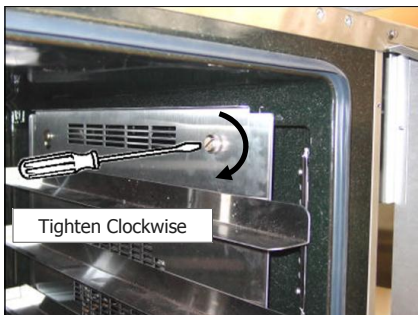

Left Rack

- Locate the top rear of the rack onto the locating peg at the top rear LH side of the oven.



- Locate the top front of the rack over the locating peg at the top front LH side of the oven.

Oven Lamp

- Remove the LH side rack as shown previously.



- Wash the glass lens with a soft sponge using warm water and a detergent solution. Rinse with clean, warm water.



- Dry the glass lens thoroughly with a dry cloth.
- Refit LH side rack as shown previously.

Cleaning and Maintenance

Door Seal

- To remove the door seal, pull the 1 piece seal forward until it pulls out of the location groove around the oven. **Note the way the seal is fitted to the oven, with the lip facing inwards.**



- Check the door seal for wear and damage and replace as required.
- Wash the door seal in a sink, taking care not to cut or damage the seal.
- Dry the door seal thoroughly.
- Refit the door seal with lip facing into centre of the oven.



- Press the door seal into the locating groove in the front face of the oven until the seal is properly located all around the oven.

Oven Interior

- Allow the oven interior to cool to approx 50°C / 120°F before commencing cleaning.
 - Remove the oven racks as shown previously.
 - Clean any build up of grease from the oven interior, using a soft bristled brush with a solution of hot water and a mild anti bacterial detergent.
 - Dry the oven thoroughly with a soft dry cloth.
 - Clean the oven regularly with a good quality oven cleaner.

Door Glass Cleaning

- Ensure that the oven door is cool before cleaning the oven door glass.
 - Open the oven door.
 - Lift up the bottom of the inner glass at the centre of the door to unlock from the inner glass retaining catches and swing the glass inwards towards the oven.

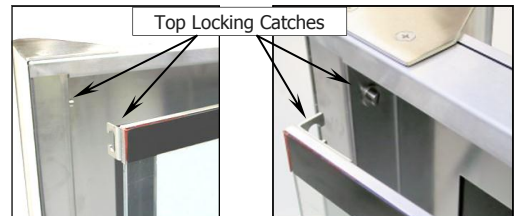
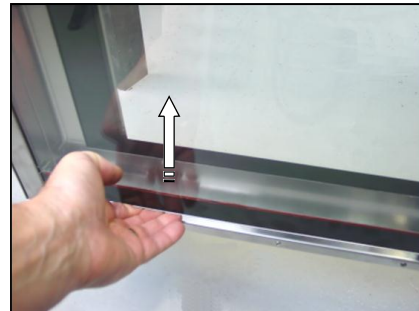

- Clean both sides of the inner glass and the inner side of the outer door glass with a conventional glass cleaner.
- Dry the oven door thoroughly with a soft dry cloth.
- Swing the inner glass back towards the outer door.
- Whilst holding the outer door, lift the inner glass back onto the locking catches until the inner glass is securely held.

Periodic Maintenance

NOTE: All maintenance operations should only be carried out by a qualified service person.

Important:

When appliances are installed on castors (double stacked, fitted on base stands, or on a proofer) and connected to the gas supply piping by means of a connector for moveable appliances, the appliance is fitted with a restraining device. If disconnection of the restraining device is necessary, ensure that it is re-connected once the appliance is returned to its original operating position.

Controls and mechanical parts should be checked and adjusted periodically by a qualified service person. It is recommended that the appliance is serviced every 6 months.

Fault Finding

This section provides a reference to the more common problems that may occur during the operation of your oven. This fault finding guide is intended to help you correct and accurately diagnose problems with your oven.

You may encounter a problem not covered in this section, please contact your service provider who will require the following information:-

When fault finding a problem, always use a process of elimination starting with the simplest solution and working through to the most complex. Never overlook the obvious.

- **The Model and Serial Number of the oven, can be found on the Technical Data Plate located on the front right hand side panel of the oven.**

Fault	Possible Causes	Remedy
Oven does not operate.	Mains isolating switch, circuit breaker or fuses are 'Off' at the power board. Overtemp tripped (No lights, no power light). Overtemp faulty. Digital Controller faulty	Turn 'On'. Call for service. Call for service. Call for service.
Oven Controller operates but:- a. Sparking operates (3 attempts) but flame not established. b. No Sparking.	No gas supply to oven. Gas Valve faulty. Ignition control is in lock-out. Door not fully closed. Door microswitch faulty. Ignition control faulty.	Check gas supply. Turn oven OFF then ON to reset ignition control. Call for service. Turn oven OFF then ON to reset ignition control. Close door (refer 'Door does not close fully'). Call for service. Call for service.
Oven heats up but fan does not operate.	Fan motor faulty. Fan or fan motor obstructed.	Call for service. Call for service.
Oven does not Steam.	Injector Nozzle blocked. Water Solenoid faulty. Controller faulty.	Call for service. Call for service. Call for service.
Door does not close fully.	Tray in way of door. Door mis-aligned. Door seal obstruction.	Correctly position tray in rack. Re-align door. Correctly install door seal. (Refer to the 'Cleaning' Section).
Oven light not illuminating.	Blown bulb.	Replace bulb.
Uneven cooking.	Too high a temperature selected. Oven or racks not level. Insufficient air space around trays or baking tins. Oven overloaded with too much product. Opening oven door un-necessarily. Oven door seal damaged or faulty. Oven vent restricted.	Select a lower temperature. Check oven racks and level. Ensure oven racks are spaced to allow air flow around baking on all shelves. Re-load oven. Ensure oven door remains closed during the baking process. Check seals and replace if damaged. Ensure oven vent not blocked or shrouded.
'Err 001' on display.	Oven probe error.	Call for service.
'Err 003' on display.	Burner Box thermal overload switch tripped.	Call for service.
'CP' flashing on Lower Display, alarm sounding, oven program paused.	Core Probe not connected to control panel, and program requires its use. Core Probe Faulty.	Connect Core Probe to control panel. Replace Core Probe.



Electrical Schematics

Electrical Schematic G32D5 Turbofan Oven

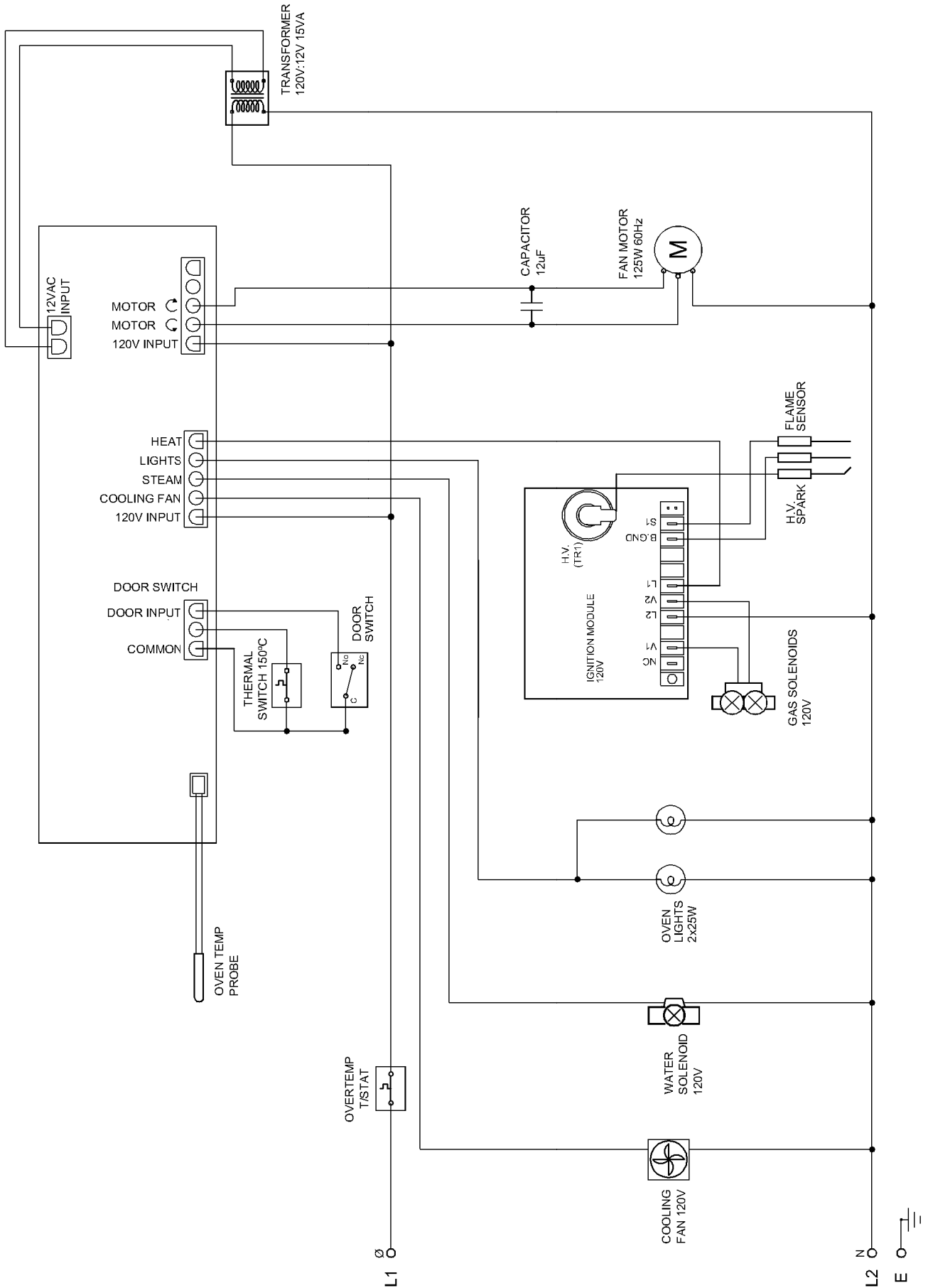

Gas Conversion and Specifications

Conversion Procedure



Caution

Ensure that the appliance is isolated from the electrical and gas supply before commencing servicing.

NOTE:

- These conversions should only be carried out by qualified persons. All connections must be checked for leaks before re-commissioning the appliance.
- Adjustment of components that have adjustments / settings sealed (e.g. paint sealed) can only be adjusted in accordance with the following instructions and shall be re-sealed before re-commissioning this appliance.
- For all relevant gas specifications refer to the 'Gas Specifications' table at the end of this section.

Procedure:

1. Remove the lower service panel to allow access to the gas control valve.
2. Unscrew and remove the regulator cover screw from the regulator incorporated in the gas control.

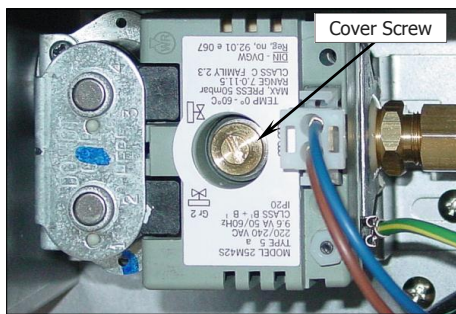

3. Remove the plastic adjusting screw and regulator spring from the gas control valve. Replace with correct spring supplied with the conversion kit.

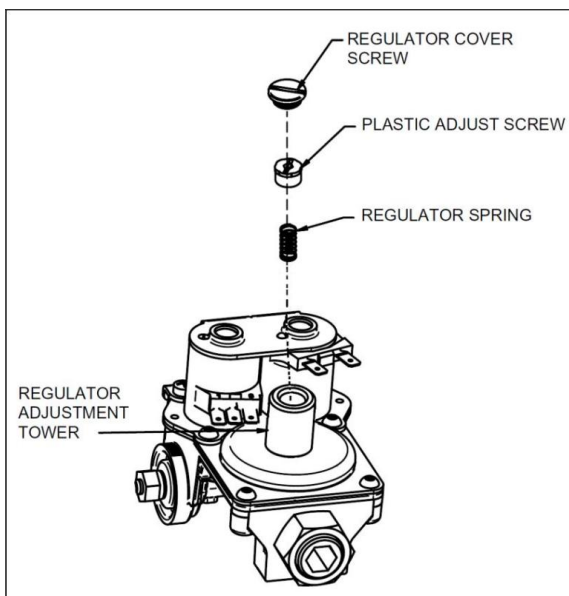

4. Unscrew and remove the main burner injector and replace with appropriate item.

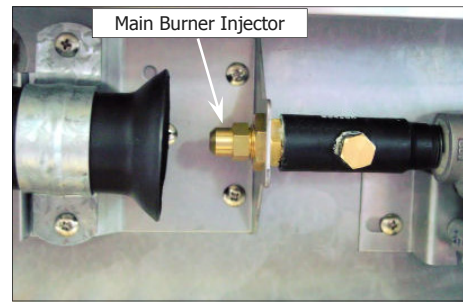

5. Connect gas and electrical supplies.
6. Operate oven and adjust the plastic adjust screw on the regulator to achieve correct pressure at pressure test point (front RH corner).
7. Refit the regulator cover screw to the gas valve.
8. Conduct full leak test of the converted oven prior to placing it into operation.



Warning

Do not use a naked flame to check for gas leakages.

9. Refit the service panels.

Gas Type Identification Label

On completion of the gas conversion, replace the gas type identification label with the appropriate label, located at:-

- The rear of the appliance, above the gas connection.

Commissioning

Before leaving the converted installation;

1. Check all gas connections for leakages using soapy water or other gas detecting equipment.
2. Check the following functions in accordance with the operating instructions specified in the 'Operation' section of this manual.
 - Ensure that all the oven controls operate correctly.
 - Ensure that the operating pressure remains correct.
3. Ensure any adjustments done to components that have the adjustments / settings sealed (e.g. paint sealed), are re-sealed.

NOTE: If for some reason it is not possible to get the appliance to operate correctly, shut off the gas supply and contact the supplier of this appliance.

Gas Specifications Table

	Natural Gas	LP Gas (Propane)
Orifice Size	#36 Drill (2.70mm).	#51 Drill (1.70mm).
Regulator Spring (Colour)	Green Spring.	Blue Spring.
Supply Pressure	7" w.c. (1.75 kPa).	11" w.c. (2.75 kPa).
Operating Pressure	4.2" w.c. (1.05 kPa).	11" w.c. (2.75 kPa).

Replacement Parts List

Important:

**Only genuine authorized replacement parts should be used for the servicing and repair of this oven. The instructions supplied with the parts should be followed when replacing components.
For further information and servicing instructions, contact your nearest authorized service provider or Turbofan Dealer.**

When ordering replacement parts, please quote the part number and the description as listed below. If the part required is not listed below, request the part by description and quote model number and serial number which is shown on the Technical Data Plate.

Item	Description
236256	Digital Control Board Kit
234450	Encoder
234447	Control Knob
234430	Transformer 110-120V x 12VAC SEC 15VA
234461	Cooling Fan 110-120V 50/60HZ
237447K	Temperature Probe Kit PT1000.
SA1530	Ignition Electrode Assembly
232552	Capacitor 12uF (110V Models)
025400	Overtemp 360°C / 680°F
232905	Fan Motor 110-120V 60HZ
232903	Fan Dia 175mm / 7"
234459	Ignition Module 110 - 120V
234458	Gas Valve G32 120V
232964	Thermal Switch 150°C
004952	Burner Painted
032170	Injector 1.70mm LPG (Propane)
032270	Injector 2.70mm NAT
235435	Gas Type Conversion Kit USA / Canada Only
015311	Test Point Plug 1/8" NPT
024802	Door Microswitch
236885	Door Microswitch Gasket
232666	Door Seal
234580	Door Roller Catch
235277	Door Roller Catch Strike
235278	Strike Lock Nut
234930	Door Hinge Assy
234757	Door Inner Glass Assembly
234752	Hinge Pivot Kit
233884	Lamp Bulb G9 25W, Halogen 120V
236214	Lamp Holder G9 25W
021352	Oven Lamp Lens
021354	Oven Lamp Gasket
021617	Water Solenoid 90° Outlet 120V
025922	Adaptor Brass (USA / Canada only)
021527	Washer Rubber (USA / Canada only)
233986	Foot Adjustable 100mm
233649	Oven Rack
234658	Oven Side Rack LH 5-tray
234667	Oven Side Rack RH 5-tray
233552	Rack Securing Screw

Optional Extras

Item	Description
236060	Core Temperature Probe Kit.
235845	Core Temperature Probe.
235847	Dust Cap - Core Temperature Socket.
236271	Core Temperature Probe Holder.

Appendix 1 - Oven Door Reversal

Reversing the Oven Door

- Refit all screw fasteners using a low-mid strength thread locking adhesive unless otherwise stated.
- Door reversal should only be carried out by a suitably competent person.

Remove the Oven Door Inner Glass.

1. Open the oven door and open the door inner glass.
2. Remove screw securing inner glass retaining clip and remove clip.
3. Lift up inner glass and remove, ensuring that pivot spacer is removed from lower inner glass pivot and retained.
4. Remove black plastic plugs from top and bottom of door and fit to holes where inner glass pivots were removed from.

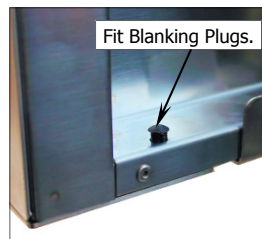
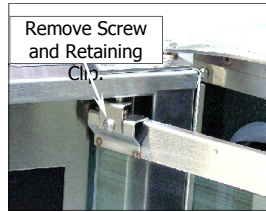

Remove the Oven Door.

5. Remove the door roller catch and blanking plate from the inside of the door and swap these over.

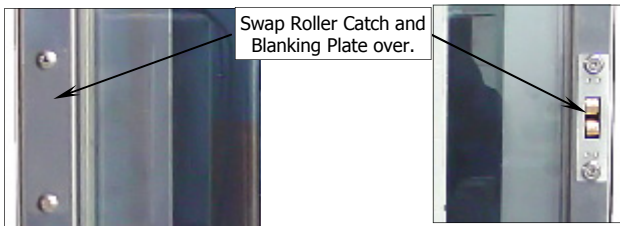

6. Whilst supporting door, unscrew and remove top door pivot bolt from top door hinge assembly.
7. Remove door and lay on a flat surface or workbench.
8. Unscrew screws securing the door handle remove door handle.
9. Remove top door hinge and fit to bottom opposite corner of door.

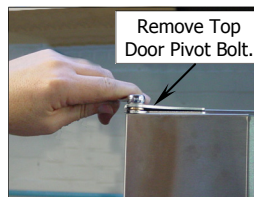

10. Remove bottom door hinge and fit to top opposite corner of door.



11. Remove inner glass latching studs and fit to opposite side of door using **Loctite 243** or similar to secure.



12. Turn door handle over and fit to other end of door where hinges were removed from. Ensure Flat of handle is to the outside.

Remove Upper and Lower Door Hinges and Door Catch.

13. Remove bottom door pivot bolt and spacers and fit pivot bolt to top door hinge assembly (as this will be swapped over and fitted to bottom of other side of oven).

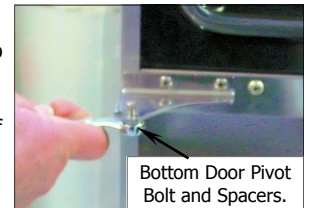

14. Remove the 4 blanking screws from front of oven.

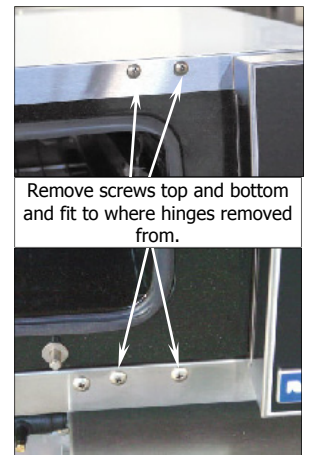

15. Remove Hinge Plate from top of oven and fit diagonally opposite, to lower corner.

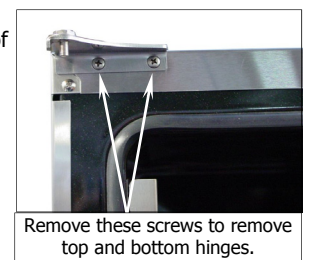

16. Remove Hinge Plate from bottom of oven and fit diagonally opposite, to upper corner.

17. Fit screws removed at Item 14 above to where hinges were fitted.



Appendix 1 - Oven Door Reversal

18. Remove Blanking Screw and Door Catch from front of oven and swap around (refer 'Adjusting Door Catch').

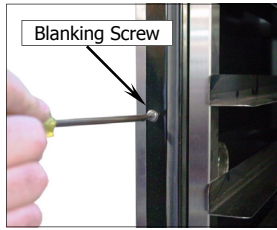

19. Fit door spacers removed at Item 13 previously, to lower hinge pivot bolt.

Oven Door Re-Fitting

Fit the Door.

1. Refit oven door by locating bottom of door onto bottom hinge plate pivot bolt and spacers.
2. Fit top of door into top hinge plate and secure with top pivot bolt.

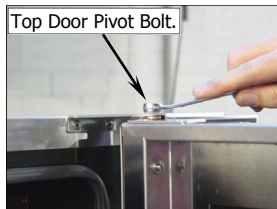

Fit Inner Glass to Door.

NOTE: It is important to ensure that the inner glass is fitted correctly and that the glass pivots at the hinge end of the door and not the handle end.

3. Fit pivot spacer removed at Item 3 on previous page, to the lower inner glass pivot and locate inner glass lower pivot into position on inside of door.

4. Locate top pivot of inner glass into top of door and secure in position with inner glass retaining clip.

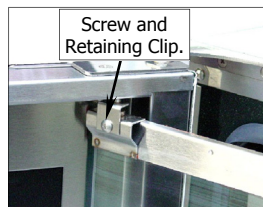

5. Lift inner glass up onto locking catch to lock glass into position.

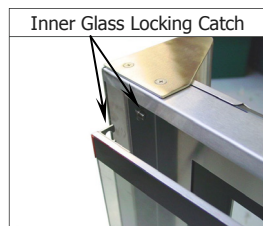

Adjust Door for Correct Alignment.

Check alignment and operation of the door. Ensure that the door is correctly aligned horizontally and vertically.

1. To align, slacken off the upper and lower hinge plates and correctly align the door. Re-tighten both hinge plates.
2. Check that the roller catch correctly retains door in the closed position.
3. To adjust, slightly loosen screws securing roller catch and close the door. The roller catch will centralise itself.
4. Open door and tighten roller catch securing screws.

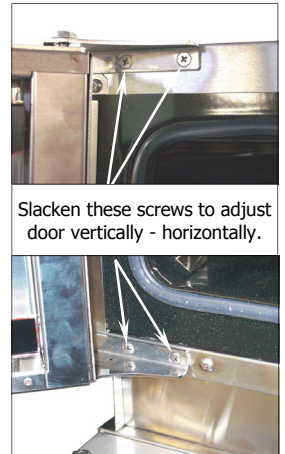

Adjusting Door Catch

If the door sealing requires adjustment, carry out the following to adjust the door catch:-

1. Check that the door seals correctly when closed, by placing a sheet of paper between the door and the seal.
2. Close the door on the paper and attempt to withdraw the paper by firmly tugging on the paper. The paper should just pull out with some resistance but without tearing.
3. To adjust the door catch, loosen the locking nut on the door catch:-
 - a. If the paper withdraws easily, **screw the door catch 'In' by ½ a turn** and repeat the test above until adjusted correctly.
 - b. If the paper cannot be withdrawn and the door springs open, **screw the door catch 'Out' by ½ a turn** and repeat the test above until adjusted correctly.
4. Tighten the locking nut on the door catch.

