



# Instructions for use

OVEN

OP8664A / BO6PY4S3-42  
OP8664B / BO6PY4S3-42  
OP8664S / BO6PY4S3-42

### Pictograms used



Important information



Tip

# CONTENTS

## ***Your oven***

Introduction	4
Description of the appliance	5
Guide rails/Telescopic guide rails	5
Accessories	6
Door	7
Cooling fan	7
Control panel	7
Control panel general use	8

## ***First use***

Before first use	10
------------------	----

## ***Use***

Explanation of the knobs and the keys	12
Description of the main functions	14
Description of the sub functions	15
Plus menu	18

## ***Operation***

Using the appliance cooking functions	19
Culisensor	20

## ***Settings***

Settings menu	21
---------------	----

## ***Maintenance***

Cleaning the appliance	22
Pyrolysis	22
Cleaning function (Steam clean)	23
Removing and cleaning the guide rails	24
Replacing the oven lamp	24
Removal and installation of the oven door	25
Removal and installation of the oven door glass	26

## ***Malfunctions***

General	27
---------	----

## ***Environmental aspects***

Disposal of the appliance and packaging	29
-----------------------------------------	----

## *Introduction*

---

Congratulations on choosing this oven. This product is designed with simple operation and optimum comfort in mind.

This manual shows how you can best use this oven. In addition to information about operating the appliance, you will also find background information that may be useful when using the appliance.



**Please read the separate safety instructions carefully before using the appliance!**

**Read this manual before using the appliance and keep it in a safe place for future use.**

The installation instructions are included separate

# YOUR OVEN

## Description of the appliance

1. Control panel
2. Oven levels
3. Oven door
4. Door handle

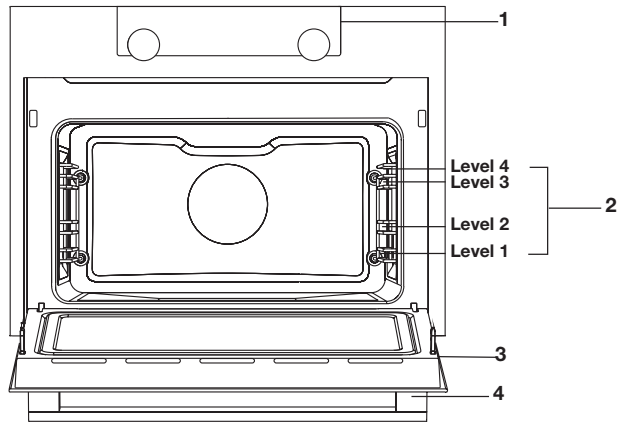

## Guide rails/Telescopic guide rails

- The oven has four or five guide rails (Level 1 to 4/5), depending on the model. Level 1 is mainly used in combination with bottom heat. The two upper levels are mainly used for the grill function.
- Place the oven rack, baking tray or steam dish in the gap between the guide rail sliders.
- A number of shelf levels can have fully-retractable telescopic guide rails, depending on the model.
  - Pull the telescopic guide rails out of the oven cavity completely and place the oven rack / baking tray / steam dish on them. Then slide the oven rack / baking tray / steam dish on the telescopic guide rails, back into the oven cavity.
  - Only close the oven door when the telescopic guide rails have been returned completely back into the oven cavity.



**Note:** remove the guide rails / telescopic guide rails out of the oven if you are going to use the Pyrolysis function!



# YOUR OVEN

## Accessories

Your appliance is accompanied by a range of accessories, depending on the model. Only use original accessories; they are specially suited to your appliance. Be sure that all the accessories that are being used are able to withstand the temperature settings of the chosen oven function.

**Note:** not all accessories are suitable/available for every appliance (it may also differ by country). When purchasing, always provide the exact identification number of your appliance. Please see the sales brochures or check online for more details about optional accessories.

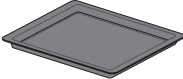
**Note:** never place an accessory on the bottom of the oven!

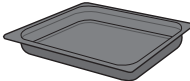
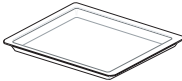
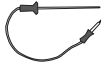
Accessories that can be supplied with your appliance (depending on the model)	
	<b>Enamelled baking tray;</b> to be used for pastries and cakes. <ul style="list-style-type: none"><li>• Do not use the enamelled baking tray for microwave functions!</li><li>• Suitable for pyrolysis cleaning.</li></ul>
	<b>Oven rack;</b> mainly used for grilling. A steam dish or pan with food can also be placed on the oven rack. <ul style="list-style-type: none"><li>• The oven rack is equipped with a safety peg. Lift the rack slightly at the front to slide it out of the oven.</li><li>• Do not use the oven rack for microwave functions!</li></ul>
	<b>Deep enamelled baking tray;</b> to be used for roasting meat and baking moist pastry. <ul style="list-style-type: none"><li>• Do not place the deep baking tray on the lowest level during a cooking process, except when using it as a drip tray during grilling, roasting or roasting with a spit roast (when available).</li><li>• Do not use the deep enamelled baking tray for microwave functions!</li><li>• Suitable for pyrolysis cleaning.</li></ul>
	<b>Glass baking tray;</b> for microwave and oven use. <ul style="list-style-type: none"><li>• NOT suitable for pyrolysis cleaning.</li></ul>
	<b>Culisensor;</b> can be used to measure the core temperature of the dish. When the desired temperature is reached, the cooking process will be stopped automatically.
	<b>Pyrolysis guide rails;</b> only use these guide rails to clean an enamelled baking tray during pyrolysis (replace the guide rails / telescopic guide rails with these special pyrolysis guide rails). <ul style="list-style-type: none"><li>• Please note: the high temperature during pyrolysis may cause the pyrolysis guide rails to discolour.</li></ul>

# YOUR OVEN

## Door

- The door switches interrupt the operation of the oven when the door is opened during use. The oven continues operating when the door is closed.

## Cooling fan

- The appliance is equipped with a cooling fan that cools the casing and control panel.

## Control panel

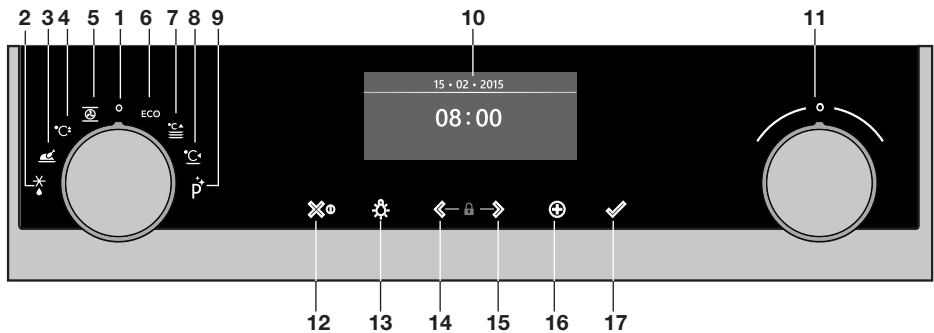

1. Function knob (in 'Off' position)
2. Defrost
3. Programs
4. Fast preheat
5. Oven
6. Eco hot air
7. Plate warming
8. Warming
9. Cleaning
10. Display
11. Selection knob
12. On/off key and stop key (cancel)
13. Light key
14. Navigation key left
15. Navigation key right
16. Plus key
17. Confirm key



The keys respond best if you touch them shortly with a large area of your fingertip. Every time you touch a key during use, a short acoustic signal will sound.

## Control panel general use

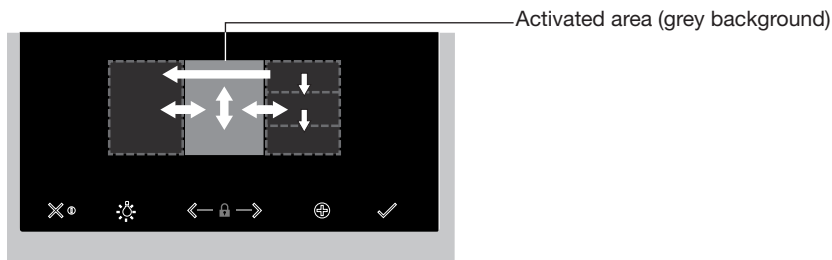

### Set a function and settings

1. Touch and hold the on/off key to switch on the appliance.
  2. Turn the function knob to set a main oven function.  
*The main oven functions are visible around the oven function knob and in the display. The function icon is displayed larger. The 'active area' (recognizable by a grey background) moves to the right.*
  3. Turn the selection knob to select a sub oven function.  
*The 'active area' shows the several different sub oven functions. Scroll up or down to view the different functions. If a chosen main function does not have a sub function then the next available setting appears in the active area.*
  4. Touch the selection knob (or the right navigation key) to confirm the chosen sub oven function or setting.  
*The 'active area' (grey background) moves to the right.*
  5. Turn the selection knob to change the next available settings (left = decrease, right = increase) and confirm by touching the selection knob or touching the right navigation key.
- When all elements in the screen are set, then confirm these settings by touching the confirm key.
  - When the confirm key is blinking it is possible to start the oven with the default settings.
  - Touch the left navigation key to move the active area to the left to change an already made setting. Change the setting by turning and touching the selection knob.
  - Touch the stop key to go one-step back in the menu.

*Follow the instructions on the display.*

# YOUR OVEN

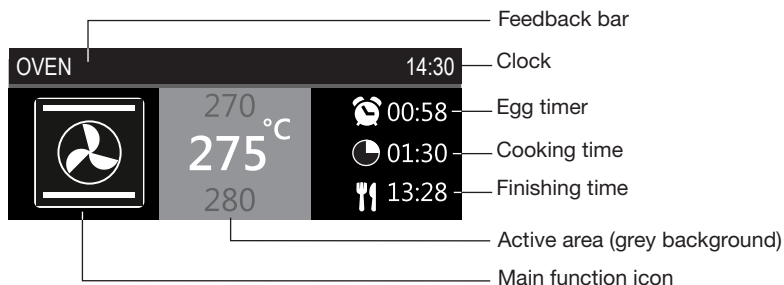

- The display will show the icon and name of the activated function for about 1.5 seconds.
- This bar shows what setting you are changing.

## Delayed start

- Set an desired cooking time and finishing time to start cooking at a later time.

## Display

When the appliance is in progress you see the following information in the display:

- Temperature
- Active oven (sub) function
- Egg time (when set / See 'Plus menu')
- Cooking time (cooking time counting up or counting down when cooking time has been set)
- Finishing time (when cooking time has been set)

## Stand-by mode

The stand-by display will show the time, date and the timer (if set). The appliance goes to stand-by mode after turning the function knob to 0 ('off' position).

## Switching on the appliance

- Touch and hold the on/off key to switch on the appliance.
- The appliance can also be switched on by turning the function knob to a function.

## Shutting down the appliance

- Touch and hold the stop key to shut down the appliance manually.
- Default the appliance will shut down when there has been no action during 30 minutes.

# FIRST USE

## Before first use

- Clean the appliance interior and accessories with hot water and washing-up liquid. Do not use aggressive cleaning agents, abrasive sponges and similar.
- The appliance will emit a particular odor when it is used for the first time; this is normal. Make sure that there is good ventilation during initial use.



When the appliance is first plugged in or after connection when the appliance was disconnected from the power mains for a long period of time, you have to set 'Language', 'Date' and 'Time'.

## Setting the language

Language	12:00
English	
Français	
Nederlands	

In case you are not comfortable with the language on the display, you can select another language. The default setting is 'English'.

1. Turn the selection knob and select your preferred language from the displayed list.
2. Confirm the setting by touching the confirm key.

*The next screen will be displayed.*

## Setting the date and time

Year	12:00		Hours	12:00	
2017	01	01	11	30	
2018			12		
			13		

1. Turn the selection knob and change the first setting (Year).
2. Confirm this setting by touching the right navigation key or by touching the selection knob.
3. Turn the selection knob and change the next setting (Month).
4. Confirm this setting by touching the right navigation key or by touching the selection knob.
5. Turn the selection knob and change the last setting (Day).
6. Confirm this setting by touching the confirm key.

*The next screen will be displayed. Now set the hours and minutes with the selection knob and navigation key. Confirm your setting by touching the confirm key.*

## FIRST USE

---

All the start-up settings are now set and the display will show the stand-by screen. The appliance is now ready for use.



The language, time and date can be adjusted in the settings menu (see 'Settings menu' chapter). The settings menu can be opened from the start display via the 'Plus' menu.

## Explanation of the knobs and the keys

### Function knob

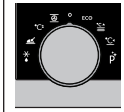

#### Select a function

Turn this knob to select the desired function.

- See 'Description of the functions' for more information.

### Selection knob



#### To choose an sub oven function

Turn this knob to choose a sub oven function.

- See 'Control panel general use' for more information.



#### Change the settings

Turn this knob to change the settings that are in the active area.

- See 'Control panel general use' for more information.



#### Go to the next setting

Touch this knob to go to the next setting.

- The next to change setting will be in the grey active area.

### On/off key and stop key



#### To switch the appliance on or off

Touch and hold the key for several seconds to switch the appliance on or off.



#### To cancel or go back in the menu

Touch this key to cancel an operation or to go back one-step in the menu.



### Lighting key





#### Switch the lighting on/off

Touch this key to switch the cavity lighting on or off.

## Navigation keys

	<p><b>Navigate to the right</b> Touch the right navigation key to confirm the setting and to move the active area to the right.</p>
	<p><b>Navigate to the left</b> Touch the left navigation key to move the active area to the left.</p>
	<p><b>Turn on/off the child lock function</b> Touch and hold the navigation keys simultaneously to activate/deactivate the child lock function.</p> <ul style="list-style-type: none"> <li>• The oven's control panel can be locked by means of the Child Safety Lock, to protect the oven against unintended use.</li> </ul>

## Plus key

	<p><b>To open the settings menu (see 'Settings')</b> Touch this key in stand-by mode to open or exit the settings menu:</p> <ul style="list-style-type: none"> <li>• Egg timer</li> <li>• General</li> <li>• Display</li> <li>• Cooking</li> <li>• System</li> </ul>
	<p><b>To open extra options (see 'Plus menu')</b> Touch this key in operation mode to open or exit the extra options possible at that moment:</p> <ul style="list-style-type: none"> <li>• Egg timer</li> <li>• Fast preheat</li> </ul>







## Confirm key

	<p><b>Confirm</b> To confirm all the white settings/elements in the screen.</p>
-------------------------------------------------------------------------------------	-------------------------------------------------------------------------------------

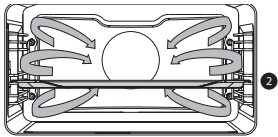

## Description of the main functions

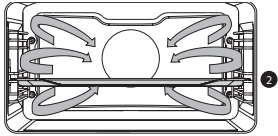
Consult the tables to select the preferred function. Also consult the instructions for preparation on the dish packaging. Some main functions have sub functions.

### Main functions (to select with the function knob)

Function	Description	
	<p><b>Oven</b></p> <ul style="list-style-type: none"> <li>• Use one of the functions available for grilling, baking or roasting.</li> <li>• Sub functions are available (consult Oven functions table).</li> </ul>	
	<p><b>Fast preheat</b></p> <ul style="list-style-type: none"> <li>• With this function, the oven space quickly reaches the desired temperature. Do not use this setting when you have a dish in the oven space.</li> </ul>	
	<p><b>Programs</b></p> <ul style="list-style-type: none"> <li>• Use 'Programs' for baking and roasting by selecting a dish from a list of pre-programmed dishes.</li> </ul>	
	<p><b>Defrost</b></p> <ul style="list-style-type: none"> <li>• With this function, the air circulates by means of the fan. The air will be heated to a temperature of 30 °C.</li> <li>• Dishes are defrosted quickly and efficiently.</li> </ul>	
	<p><b>ECO Hot air</b></p> <ul style="list-style-type: none"> <li>• Heating by means of hot air. ECO hot air uses less energy but gives the same result as the hot air setting. Cooking takes a few minutes longer.</li> <li>• This mode can be used for roasting meat and baking pastry.</li> <li>• Place the baking tray in the middle of the oven.</li> <li>• Suggested temperature: 180 °C</li> <li>• This setting makes use of the residual heat (heating is not on the whole time) to achieve low energy consumption (in accordance with energy class EN 60350-1). In this mode the actual temperature in the oven is not displayed.</li> </ul>	
	<p><b>Plate warming</b></p> <ul style="list-style-type: none"> <li>• This function is used for warming tableware, so that the served food stays hotter for longer.</li> </ul>	







# USE

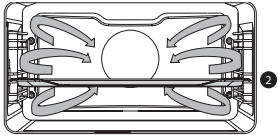

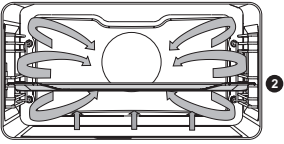

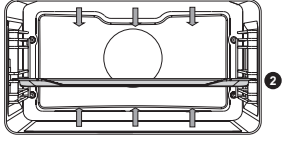

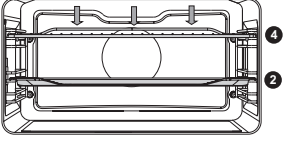
Function	Description	
	<p><b>Warming</b></p> <ul style="list-style-type: none"> <li>This function is used to keep already cooked dishes warm.</li> </ul>	
	<p><b>Cleaning</b></p> <ul style="list-style-type: none"> <li>Sub functions are available (select with the selection knob):</li> </ul> <p><b>Pyro clean</b></p> <ul style="list-style-type: none"> <li>This function is intended for the automatic cleaning of the oven. The oven heats up to a temperature far above normal use, ensuring grease residues and other dirt are reduced to ash.</li> <li>Before using this process, remove all accessories and loose food residues from the oven cavity. During the pyrolytic self-cleaning process, the oven door is automatically locked above a certain temperature. The outside of the oven becomes hotter than usual.</li> <li>When the oven is completely cool, the inside can be wiped clean with a damp cloth.</li> </ul> <p><b>Steam clean</b></p> <ul style="list-style-type: none"> <li>Grease and grime can easily be removed from the oven walls with a damp cloth.</li> </ul>	

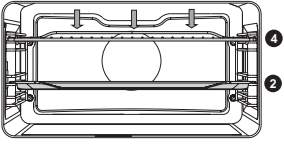
## Description of the sub functions

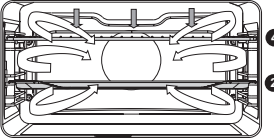
### Oven functions (to select with the selection knob)

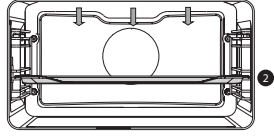
	<p><b>Hot Air</b></p> <ul style="list-style-type: none"> <li>Heating by means of hot air from the back of the oven.</li> <li>This mode provides uniform heating and is ideal for baking.</li> <li>Place the baking tray or oven rack in the middle of the oven.</li> <li>Suggested temperature: 180 °C</li> <li>Preheating is recommended.</li> </ul>	
-------------------------------------------------------------------------------------	-------------------------------------------------------------------------------------------------------------------------------------------------------------------------------------------------------------------------------------------------------------------------------------------------------------------------------------------------------	--------------------------------------------------------------------------------------

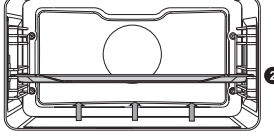
	<p><b>Hot Air + Bottom Heat</b></p> <ul style="list-style-type: none"> <li>• Heating by means of hot air from the back of the oven and the bottom heating element.</li> <li>• This mode can be used to bake pizza, moist pastry, fruitcakes, leavened dough and short crust.</li> <li>• Place the baking tray or oven rack in the middle of the oven.</li> <li>• Suggested temperature: 200 °C</li> <li>• Preheating is recommended.</li> </ul>	
	<p><b>Top + Bottom Heat</b></p> <ul style="list-style-type: none"> <li>• Heating by means of the upper and lower heating elements.</li> <li>• This mode can be used for traditional baking and roasting.</li> <li>• Place the baking tray or oven rack in the middle of the oven.</li> <li>• Suggested temperature: 200 °C</li> <li>• Preheating is recommended.</li> </ul>	
	<p><b>Large Grill</b></p> <ul style="list-style-type: none"> <li>• Heating by means of the upper element and grill element.</li> <li>• This mode can be used with dishes and baked goods that require a distinctive bottom crust or browning. Use just before the end of the baking or roasting time.</li> <li>• Place the oven rack in the upper part of the oven and the baking tray in the middle of the oven.</li> <li>• Monitor the cooking process at all times. The dish may burn quickly due to the high temperature.</li> <li>• Preheating is recommended.</li> <li>• <b>Maximum allowed temperature: 240 °C</b></li> </ul>	
	<p><b>Grill</b></p> <ul style="list-style-type: none"> <li>• Heating by means of the grill element.</li> <li>• This mode can be used for grilling a smaller amount of open sandwiches, beer sausages, and for toasting bread.</li> <li>• Place the oven rack in the upper part of the oven and the baking tray in the middle of the oven.</li> <li>• Monitor the cooking process at all times. The dish may burn quickly due to the high temperature.</li> <li>• Preheating is recommended.</li> <li>• <b>Maximum allowed temperature: 240 °C</b></li> </ul>	

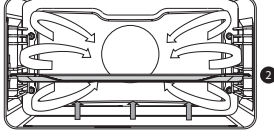
	<p><b>Large grill + Fan</b></p> <ul style="list-style-type: none"> <li>• Heating by means of the top heating elements. The heat is distributed by the fan.</li> <li>• This mode can be used for grilling meat, fish and vegetables.</li> <li>• Place the oven rack in the upper part of the oven and the baking tray in the middle of the oven.</li> <li>• Suggested temperature: 170 °C</li> <li>• Monitor the cooking process at all times. The dish may burn quickly due to the high temperature.</li> <li>• Preheating is recommended.</li> </ul>	
	<p><b>Top heat</b></p> <ul style="list-style-type: none"> <li>• Heating only by means of the upper heating element.</li> <li>• This mode can be used when you wish to bake/roast the top part of your dish.</li> <li>• Place the baking tray or oven rack in the middle of the oven.</li> <li>• Suggested temperature: 150 °C</li> </ul>	
	<p><b>Bottom heat</b></p> <ul style="list-style-type: none"> <li>• Heating only by means of the lower heating element.</li> <li>• This mode can be used with dishes and baked goods that require a distinctive bottom crust or browning.</li> <li>• Place the baking tray or oven rack in the lower part of the oven.</li> <li>• Use just before the end of the baking or roasting time.</li> <li>• Suggested temperature: 160 °C</li> </ul>	
	<p><b>Bottom heat + Fan</b></p> <ul style="list-style-type: none"> <li>• Heating by means of the lower heating element. The heat is distributed by the fan.</li> <li>• This mode can be used for baking low leavened cakes, as well as for preservation of fruit and vegetables.</li> <li>• Place a not too high baking tray in the lower part of the oven, so that hot air can also circulate over the upper surface of the food.</li> <li>• Suggested temperature: 180 °C</li> </ul>	

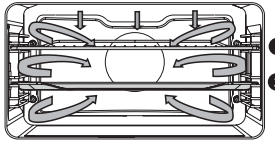
	<p><b>Pro roasting</b></p> <ul style="list-style-type: none"> <li>• Heating by means of the upper heating element in combination with the grill heating element and hot air.</li> <li>• This mode can be used for roasting all types of meat.</li> <li>• Suggested temperature: 180 °C</li> </ul>	
-----------------------------------------------------------------------------------	---------------------------------------------------------------------------------------------------------------------------------------------------------------------------------------------------------------------------------------------------------------------------------------------------	------------------------------------------------------------------------------------

## Plus menu

Touch the Plus key to choose extra functionality (after you have chosen a main function and settings).

- Select a function in the plus menu by turning the selection knob and confirm with the confirm key.
- To exit the plus menu, touch the 'stop key' or 'plus key'; the display will show the previous screen again.

Plus menu	Description
	<p><b>Egg timer</b></p> <p>The egg timer can be used independently of the oven function.</p> <ul style="list-style-type: none"> <li>• When the egg timer goes off, a message pop-up will appear and an acoustic signal will sound.</li> <li>• Touch the stop key to switch off the signal and close the pop-up menu.</li> <li>• The sound will stop automatically after approximately two minutes.</li> <li>• To cancel the timer, set the time to 0:00.</li> </ul>
	<p><b>Fast preheat</b></p> <p>Switch default fast preheat on/off (only available in oven functions).</p>

## Starting with fast preheat

- When a program is started and fast preheat is set default 'on' in the settings menu, a pop-up will appear. After 15 seconds the pop-up will automatically disappear. The progress screen will show the fast preheat icon, the time will be greyed out.
- If the set temperature is reached a message will pop-up. Insert the dish and the program will start automatically when the door is closed.

### Using the appliance cooking functions

Consult 'Control panel general use' to get information about the general operation of the appliance.

1. Touch the 'On/off key to switch on the appliance.
2. Turn the function knob to select a main function.
  - Consult 'Description of the functions' to select the appropriate (available) function.
3. Turn the selection knob to select a sub function (when available) or to adjust a setting.
  - The first sub-function setting is active (when available).
4. Start directly the selected function (with pre-set values) by touching the confirm key (this key is blinking if it is possible to start the program).

Available functions or settings to adjust:

- the function (sub oven function);
- the oven temperature;
- the cooking time.

*The next sub-function or setting becomes active (if available). Go back to an previous selection or setting by touching the left navigation key.*



If preferred, select any additional setting (for example 'Fast preheat') using the plus menu. See 'Plus menu' for more information.

5. Touch the confirm key to start preparing your meal with the chosen settings.

#### **At the end of the cooking you can:**

- Pause or stop cooking. *A pop-up message will appear.*
  - Touch the confirm key.  
*The finish display will be closed and the stand-by screen will be shown. If there is no action within 10 minutes, the display will switch to stand-by mode.*
- Add extra time
  - Touch the right navigation key to select 'Add extra time'.  
*The time setting becomes active and can be changed directly by rotating the selection knob.*
  - Touch the confirm key.
  - *The previous process is activated again.*

## OPERATION

### Changing settings during the progress

- During progress, touching the navigation keys will show the active area. The selected setting can now be changed. After confirmation with the confirm key the progress screen will be shown with the changed settings.
- After 5 seconds without actions the progress settings are cancelled and the display will return to the progress screen.

### Culisensor (when available)

If the culisensor is plugged in, the culisensor screen will be shown and a small culisensor icon will appear next to the time. The oven operates until the food core reaches the set temperature. The core temperature is measured by means of the temperature probe.

1. Screw the metal cover from the connection point (front top corner of the right side wall).
2. Put the culisensor plug in the connection and insert the culisensor completely into the food.

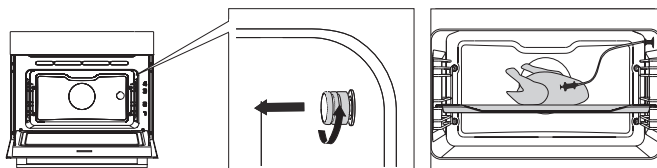

*The display will show the culisensor screen and icon.*

3. Set the function and temperature. Instead of the time, you need to set the core temperature (between 30 -100 °C).
4. Start the progress by touching the confirm key.
5. During cooking, the rising temperature of the core will be displayed (the desired core temperature may be adjusted during the cooking process).
6. When the set core temperature is reached, the cooking process will stop. An acoustic signal will sound, which you may turn off by touching any key. After one minute, the acoustic signal will be switched off automatically. The current time appears on the display.



#### **Please note!**

- Always place the culisensor's entire metal sensor in the dish.
- After the cooking process always replace the metal cap on the culisensor's connection.
- Only use the culisensor in your oven.
- Ensure that the culisensor does not come into contact with the heating element during cooking.
- The culisensor will be extremely hot after the cooking process. **Be careful! Avoid burns.**

# SETTINGS

## Settings menu

The settings menu is only available by touching the plus key when the appliance is in stand-by mode.

<b>Egg timer (setting an alarm time)</b>
<b>General</b> <ul style="list-style-type: none"><li>• Language of the display</li><li>• Time<ul style="list-style-type: none"><li>▷ Set time</li><li>▷ Hour format</li><li>▷ Clock size</li></ul></li><li>• Date<ul style="list-style-type: none"><li>▷ Date yy-mm-dd</li><li>▷ Date format</li></ul></li><li>• Sound<ul style="list-style-type: none"><li>▷ Volume (low-mid-high)</li><li>▷ Key sound (on / off)</li><li>▷ Welcome sound (on / off)</li></ul></li></ul>
<b>Display</b> <ul style="list-style-type: none"><li>• Brightness low, mid, high</li><li>• Oven light<ul style="list-style-type: none"><li>▷ Auto. switch off after 1 min.</li><li>▷ Switch off manually</li></ul></li><li>• Night mode<ul style="list-style-type: none"><li>▷ Start and end time for lower display brightness:<ul style="list-style-type: none"><li>▷ First display set start timer, second display set end time</li></ul></li></ul></li><li>• Appliance to stand-by<ul style="list-style-type: none"><li>▷ Auto. switch off after 1 hour</li><li>▷ Always on*</li></ul></li></ul>
<b>Cooking</b> <ul style="list-style-type: none"><li>• Program intensity<ul style="list-style-type: none"><li>▷ Low / medium / high</li></ul></li><li>• Preheat settings<ul style="list-style-type: none"><li>▷ Default on / off</li></ul></li></ul>
<b>System</b> <ul style="list-style-type: none"><li>• Appliance information<ul style="list-style-type: none"><li>▷ Appliance name and SW version</li></ul></li><li>• Factory settings<ul style="list-style-type: none"><li>▷ Return to factory settings</li></ul></li></ul>



**\*Changing to manually switch off will increase energy consumption.**

**If the oven is switched off manually (or when an interruption of the power supply occurs) this function will be reset (the display will automatically switch off).**

## Cleaning the appliance

Clean the oven regularly to prevent fat and food particles from accumulating, especially on the surfaces of the interior and the exterior, the door and the seal.

- Activate the child lock (to prevent that the appliance is switched on accidentally).
- Clean the exterior surfaces with a soft cloth and warm soapy water.
- Next wipe with a clean, damp cloth and dry the surfaces.
- Remove splashes and stains on the interior surfaces with a cloth and soapy water.
- Next wipe with a clean, damp cloth and dry the surfaces.



### **Important!**

**Make sure that no water enters the vents. Never use abrasive cleaning materials or chemical solvents. Always make sure that the seal of the door is clean.**

**This prevents accumulation of dirt and allows you to close the door properly.**

## Pyrolysis

Instead of cleaning manually, you can clean the oven space or an enamelled baking tray using the 'Pyrolysis' oven feature. During pyrolysis the oven space is heated to a very high temperature. Contaminants that are present incinerate at this high temperature and only ash remains.



With average use of the oven, we recommend running the pyrolysis function once per month.



### **Caution!**

- ▶ **First**, remove all accessories and guide rails / telescopic guide rails from the oven (see 'Removing and cleaning the guide rails').
- ▶ Then remove any remaining food from the oven space and wipe the space with a damp cloth. Chunks of food and fat may ignite during the pyrolysis process. **Fire hazard!**
- ▶ **Note!** The oven space and an enamelled baking tray cannot be cleaned at the same time using the pyrolysis function. If you want to clean an enamelled baking tray using pyrolysis, then do this first (the oven space can become dirty due to the cleaning of the baking tray). Insert one baking tray at a time. After that, the oven space can be cleaned.
- ▶ **Caution!** Do NOT clean the glass baking tray using the 'Pyrolysis' oven feature.

## **Starting the Pyrolysis function**

1. Make sure the oven space is completely empty and no chunks of food and fat are present!
2. If you want to clean an enamelled baking tray first, place the special pyrolysis guide rails in position. Wipe the baking tray with a damp cloth and slide the baking tray into the oven on Level 2.

# MAINTENANCE

- ▶ Remove these special pyrolysis guide rails after the cleaning process.
- 3. Select 'Pyrolysis' with the function knob and selection knob.
- 4. Select the desired cleaning intensity:
  - ▶ Low: approximately 3 hours
  - ▶ Average: approximately 3,5 hours
  - ▶ High: approximately 4 hours



Only the cleaning intensity can be selected. The time is fixed and depends on the selected cleaning intensity.

- 5. Touch on the confirm button to start pyrolysis clean.
- After a certain period the oven door will be locked automatically for your own safety (once the temperature reaches 250 °C).  
An unpleasant smell may be released from the oven during the cleaning process.
  - The oven door can be opened once the appliance has cooled down (after the end of the pyrolysis cleaning).
  - When the oven has cooled down, you can easily wipe away most residues with a damp cloth. Depending on soiling levels in the oven, there may be visible deposits on the door and below in the oven cavity. This is best removed using a non-abrasive sponge and a mild solution of warm water and washing-up liquid. Only warm water and washing-up liquid is normally enough to clean the sealing because this is only dust. Wipe the oven door and the adjacent surfaces around the door seal. Do not rub the seal.

## Cleaning function (Steam clean)

With Steam clean and a damp cloth, you can easily remove grease and dirt from the oven walls.

### **Using Steam clean**

- Only use Steam clean when the oven has cooled down fully. It is more difficult to remove dirt and grease if the oven is hot.
  - The program takes 30 minutes. Food remains on the enamel walls will be sufficiently soaked after 30 minutes so that they can be removed with a damp cloth.
1. Remove all accessories from the oven.
  2. Pour 0.15 litres of water into the bottom of the oven.
  3. Select 'Steam clean' with the function knob and selection knob.
  4. Touch the confirm key to start Steam clean.



Do not open the door during the cleaning program.

## MAINTENANCE

### Removing and cleaning the guide rails

Use conventional cleaning products to clean the guide rails.

1. Remove the screw using a screwdriver.
2. Remove the guide rails from the holes in the back wall.

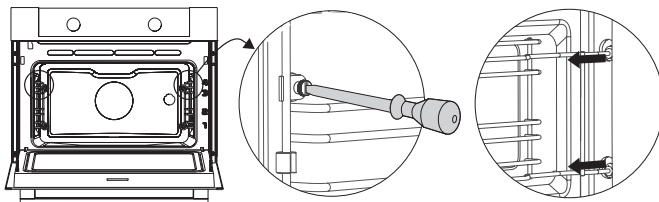

### Replacing the oven lamp



**The lamp in this household appliance is only suitable for illumination of this appliance. The lamp is not suitable for household room illumination.**



The lamp is a consumer item and therefore not covered by warranty. Replace the defective lamp with a lamp of the same type.



**Disconnect the appliance from the power supply by removing the plug from the socket or by switching off the circuit breaker in the fuse box.**

**Please note: the light bulb can be very hot! To prevent burns, use protection to remove the light bulb.**

1. Use a flat screwdriver to loosen the bulb cover, and remove it.  
*NOTE: Be careful not to scratch the enamel.*
2. Remove the light bulb and install a new one.

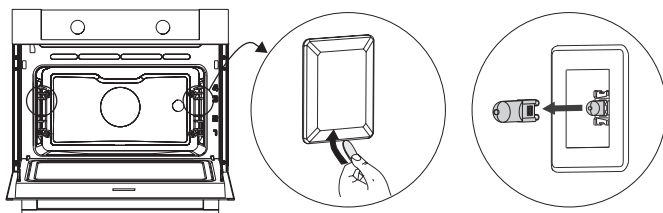

## Removal and installation of the oven door

Keep your fingers away from the hinges of the oven door. The hinges are spring loaded and can cause injury if they spring back. Make sure that the hinge latches are applied correctly to lock the hinges.

### Remove the oven door

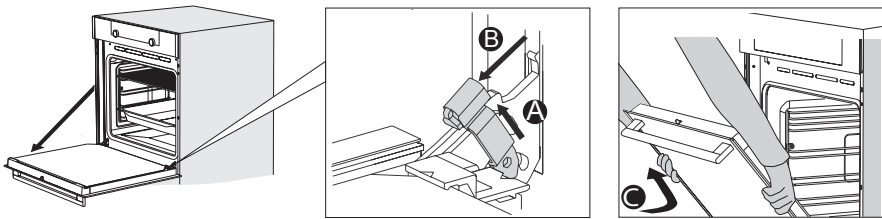

1. Open the door to the fully open position.
2. Lift both hinge latches (A) and pull them towards the oven door (B). The hinges will be locked in the 45° position.
3. Gently close the door until it reaches a 45° angle.
4. Remove the door by lifting and tilting it towards the oven (C). The hinges need to come out of the slots in the oven.

### Install the oven door

1. Hold the door at an angle of approximately 45° in front of the oven.
2. Insert the hinges into the slots and make sure they are both positioned correctly.
3. Open the door to the fully open position.
4. Lift both hinge latches and move them towards the oven.
5. Gently close the oven door and make sure that it closes correctly. If the door does not open or close correctly, then make sure that the hinges are positioned correctly in their slots.

# MAINTENANCE

## Removal and installation of the oven door glass

The inside of the glass in the oven door can be cleaned. For this it must be removed from the oven door.

1. Slightly lift (1) and shift (2) the clamps at the lower left and right of the door to release the glass (A).
2. Grab the glass (A) at the bottom and gently lift (3) and shift (4) it to remove it from the upper support.
3. The inner glass (B) (depending on the model) can be removed by carefully lifting (5) and shifting (6) it to removing it from the lower support. Also remove the rubber spacers (C) from the inner glass.

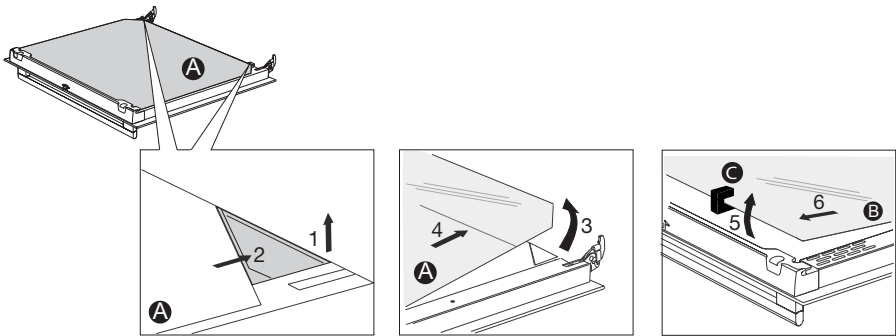

Install the glass in reverse order.

# MALFUNCTIONS

## **General**

---

If you have problems with your oven, consult the error overview below. Should the problems persist, please contact the Customer Services Department.

### **The food stays raw**

- Check whether the timer has been set and you have touched the confirm key.
- Is the door closed properly?
- Check whether a fuse has blown and whether a circuit breaker has been activated.

### **The food is overcooked or undercooked**

- Check whether the correct cooking time has been set.
- Check whether the correct power has been set.

### **The keys do not respond; the display does not respond to the keys.**

- Disconnect the appliance from the power supply for a few minutes (remove the mains plug from the socket or switch the circuit breaker to off); then reconnect the appliance and switch it on.

### **Sparking in the oven space.**

- Ensure that all cover panels from the lamps are secure and that all spacers are placed on the guide rails.

### **Power failure can cause the display to reset.**

- Remove the plug from the socket and put it back in again.
- Set the time again.

### **There is condensation in the oven.**

- This is normal. Wipe the oven clean after use.

### **The fan keeps working after the oven is switched off.**

- This is normal. The fan will keep working for a while after the oven is switched off.

### **Air flow can be felt at the door and the exterior of the appliance.**

- This is normal.

### **Light reflects on the door and the exterior of the appliance.**

- This is normal.

### **Steam escapes from the door or the vents.**

- This is normal.

## MALFUNCTIONS

**Clicking sounds can be heard when the oven is working, particularly in the defrost setting.**

- This is normal.

**The circuit breaker switches off regularly.**

- Consult a service technician.

**The display gives an error code, ERROR XX ... (XX indicates the number of the error).**

- There is a fault in the electronic module. Disconnect the appliance from the power supply for a few minutes. Then reconnect it and set the current time.
- Consult a service technician if the error persists.

**Storing and repairing the oven**

- Repairs should only be performed by a qualified service technician.  
If maintenance is required, take the plug from the socket and contact the ASKO customer service.

**Have the following information to hand when you call:**

- The model number and serial number (stated on the inside of the oven door)
- Guarantee details
- A clear description of the problem



Choose a clean, dry place if you have to store the oven temporarily, as dust and moisture can damage the appliance.

# ENVIRONMENTAL ASPECTS

## Disposal of the appliance and packaging

This product is made from sustainable materials. However, the appliance must be disposed of responsibly at the end of its useful life. The government can provide you with information about this.

The appliance packaging can be recycled. The following materials have been used:

- cardboard;
- polyethylene film (PE);
- CFC-free polystyrene (hard PS foam).

Dispose of these materials responsibly in accordance with legal provisions.



The product has a pictogram of a crossed-out waste container. This indicates that household appliances must be disposed of separately. This means that the appliance may not be processed via the regular waste flow at the end of its useful life. You should take it to a special municipal waste depot or a sales outlet that offers to do this for you.

Collecting household equipment separately prevents harm to the environment and public health. The materials used in manufacturing this appliance can be recycled, which provides considerable savings in energy and raw materials.

### **Declaration of Conformity**



We hereby declare that our products satisfy the applicable European Directives, Orders and Regulations, as well as the requirements stated in the referenced standards.







The appliance rating label is located on the inside of the appliance.

When contacting the service department,  
have the complete type number to hand.

You will find the addresses and phone numbers of the service  
organisation on the guarantee card.

 **ASKO**



687767

en (06-18)