

Smart Garage Door Opener

User Manual



THIRD REALITY

Contents

Introduction	01
What's in the Box	01
LED Indicator Reference	02
Installation & Setup	03
Pairing with 3R-Installer App	06
Pairing with Apple Home	08
Pairing with SmartThings	11
Pairing with Alexa	14
Pairing with Google Home	17
Pairing with Home Assistant	19
Troubleshooting	22
FCC Regulatory Conformance	23
RF Exposure	24
Limited Warranty	24

Introduction

The Smart Garage Door Opener Kit is a smart home device featuring a controller and tilt sensor for intuitive garage door management and real-time status updates. It connects through Matter over Wi-Fi and seamlessly integrates with popular smart home platforms. Designed for quick setup and reliable performance, the kit allows users to open or close their garage door and monitor its status at any time—whether locally or via compatible apps.

What's in the Box

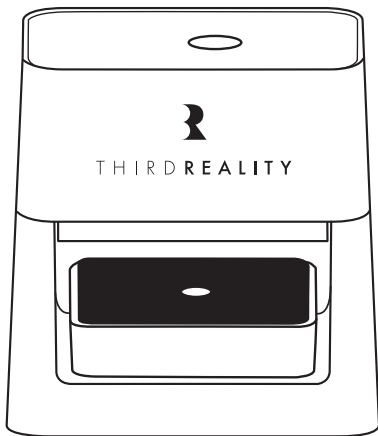

Smart Garage Door Opener × 1

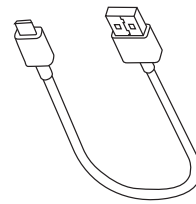

USB Type-C Cable (1m) × 1

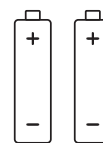

AAA Battery × 2

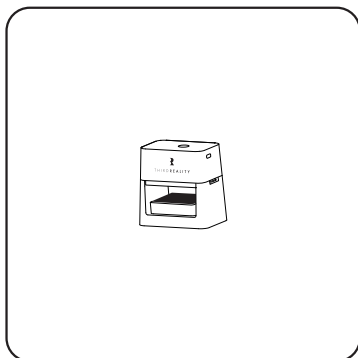

Garage Door Tilt Sensor × 1

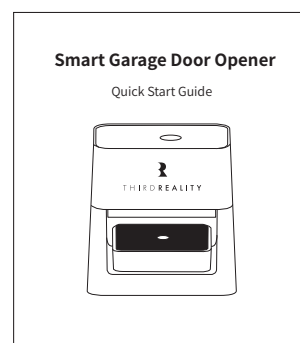

Quick Start Guide × 1

LED Indicator Reference

Smart Garage Door Opener:

Garage Door Tilt Sensor:

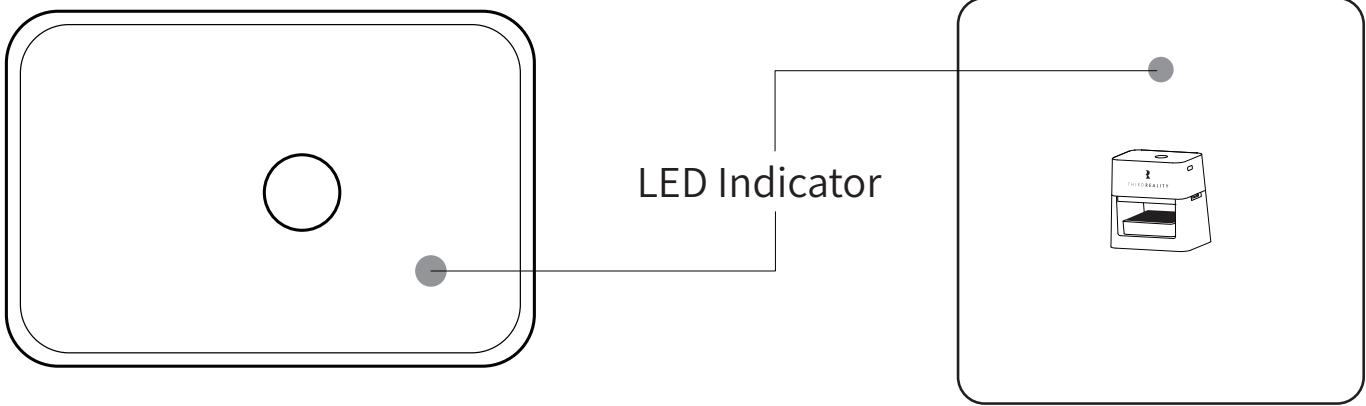

Device	Status	Color	Description
Smart Garage Door Opener	Fast Blinking	Blue	Pairing Mode
	Off		Idle/no power
	Steady	Red	Factory Reset
Garage Door Tilt Sensor	Blink Once	Red	Tilt Detected

Installation & Setup

1. Install the Garage Door Tilt Sensor

Open the battery cover of the tilt sensor and remove the insulation tab to power on the sensor. Clean the surface of the garage door where the sensor will be attached. Remove the release liner from the double-sided adhesive tape, then firmly attach the sensor and press to ensure secure adhesion.

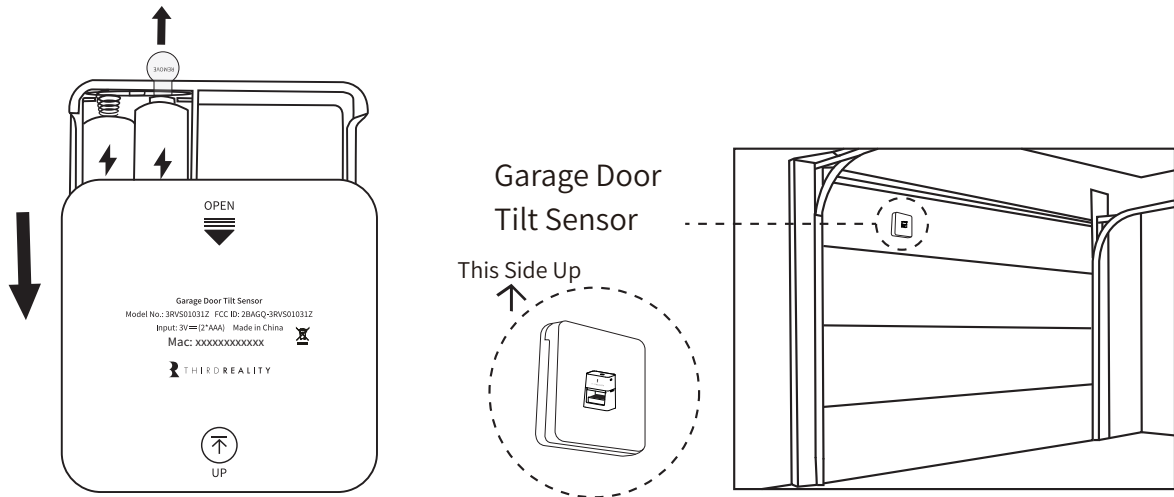

2. Set up the Smart Garage Door Opener

Connect the Type-C cable included in the package to the Smart Garage Door Opener, and plug the other end into a power adapter (not included). The blue LED indicator on the Smart Garage Door Opener will blink rapidly, indicating that the device has entered pairing mode. If the blue LED does not blink rapidly, please press and hold the button on the Smart Garage Door Opener to perform a factory reset.

3. **Pair with Matter Platform**

Launch the compatible App on your smartphone (e.g., Apple Home, Google Home, Amazon Alexa, SmartThings, or Home Assistant). Please ensure that both your smartphone and the device are connected to a 2.4GHz Wi-Fi network, as 5GHz networks are not supported.

Select “Add Device” and scan the QR code provided in the user manual or printed on the surface of the Smart Garage Door Opener. Follow the on-screen instructions in the App to complete the setup. Once the configuration is finished, you may rename the Garage Door Opener and assign it to a specific area.

4. **Install the Garage Door remote control**

Press downward on the latch located on the side of the Smart Garage Door Opener and slide the upper section of the unit to separate the remote-control holder from the actuator module. Position the garage door remote control so that the open/close button is centered within the circular opening of the holder. Adjust the clamping platform by turning the knob at the bottom until the remote control is securely in place. Once properly positioned, reattach the actuator module by aligning it with the holder and sliding it back into place until it clicks into place.

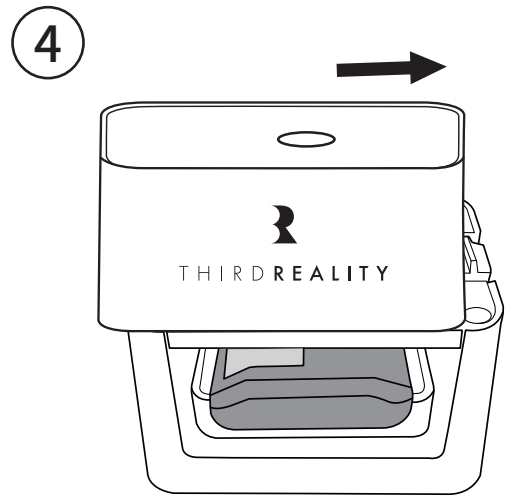
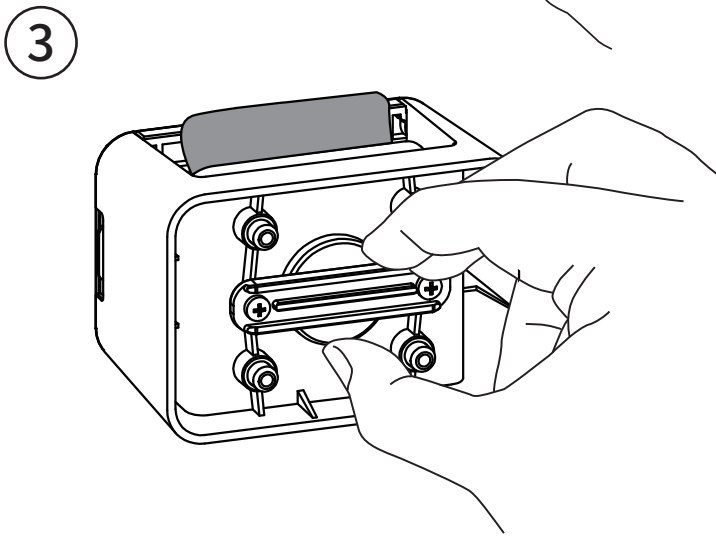
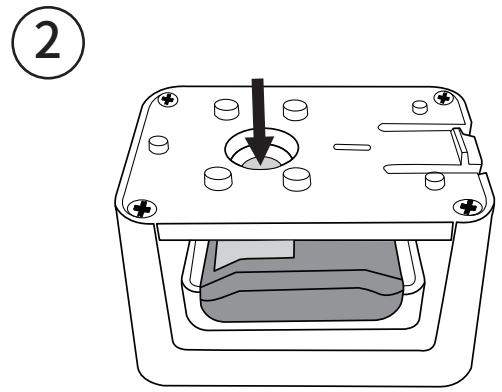
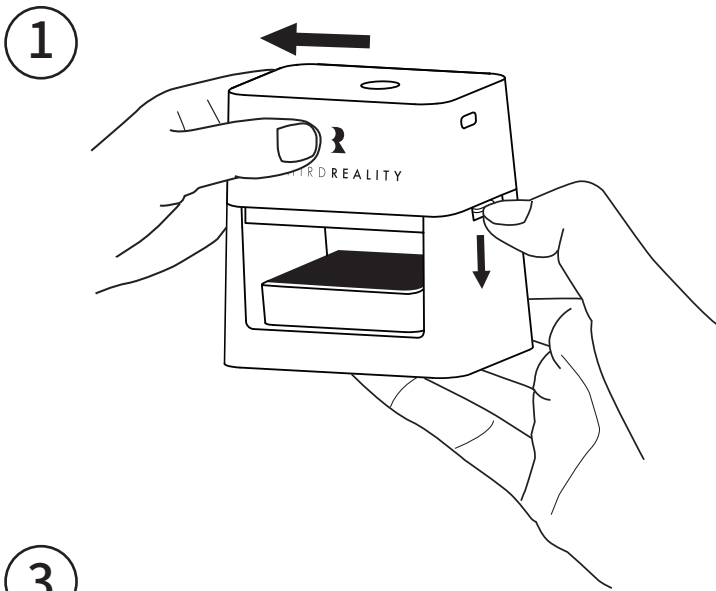

5. Finish Setup

Finally, press the button on the top of the Garage Door Opener briefly to test whether the door opens and closes properly. You can monitor and control the garage door's status through your smart home platform.

Pairing with 3R-Installer App

This Matter certified device can be paired to any Matter certified ecosystems.



1. Download and install 3R-Installer App in App Store/Google Play Store on your phone. Turn on Bluetooth on your phone, and make sure it has a stable internet access through a 2.4GHz WiFi network.
2. Power up the Smart Garage Door Opener, the blue LED flashes rapidly, indicating it is in pairing mode. If it is not in pairing mode, please press and hold the button on the Smart Garage Door Opener to perform a factory reset.
3. Tap + in the up right in 3R-Installer App, scan MATTER QR code on your Smart Garage Door Opener, follow the instructions in the app to complete setup.
4. After pairing is complete, click the garage door opener icon to enter the device page, then tap Check Updates for firmware OTA. Important: Stay in this page during OTA. Exiting requires a restart for OTA.
5. Tap Link with Matter Enable Services to add the garage door opener to another Matter controller through multi-admin.

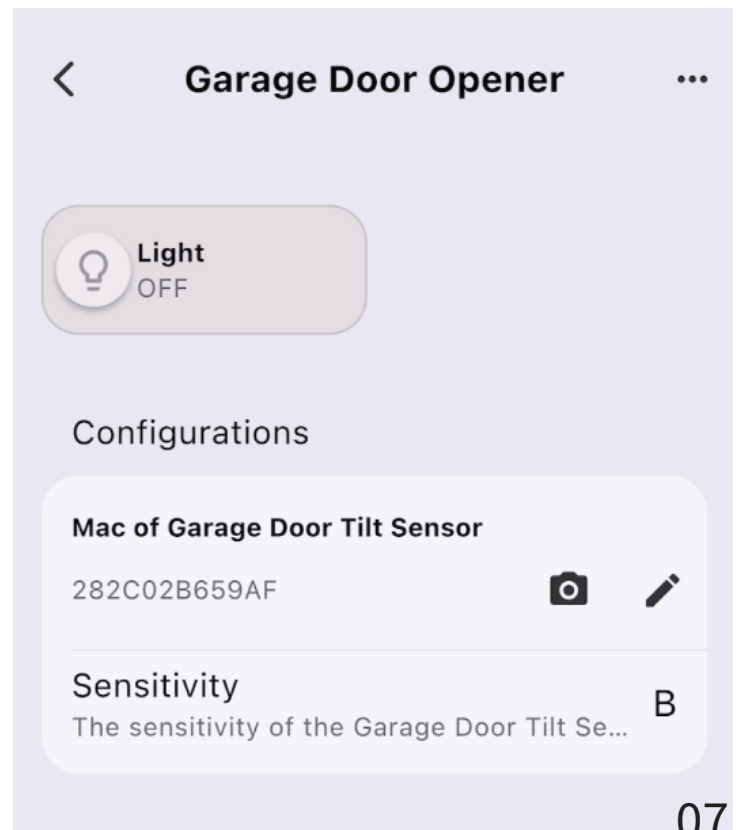
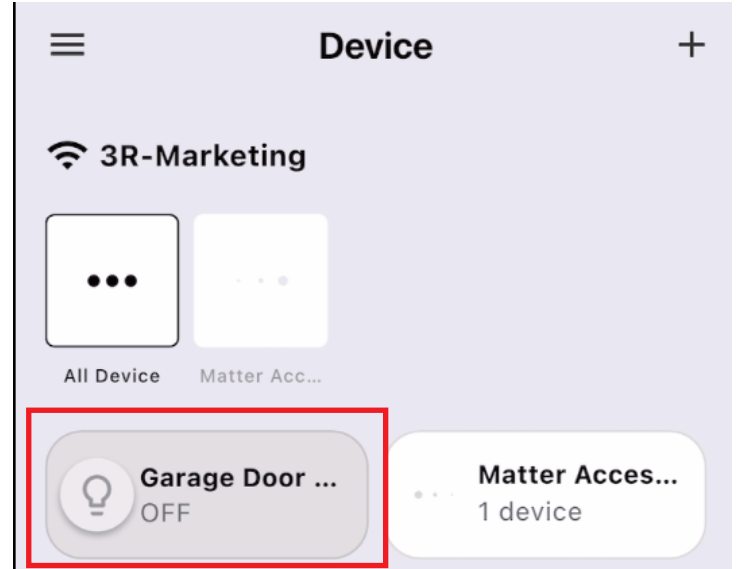
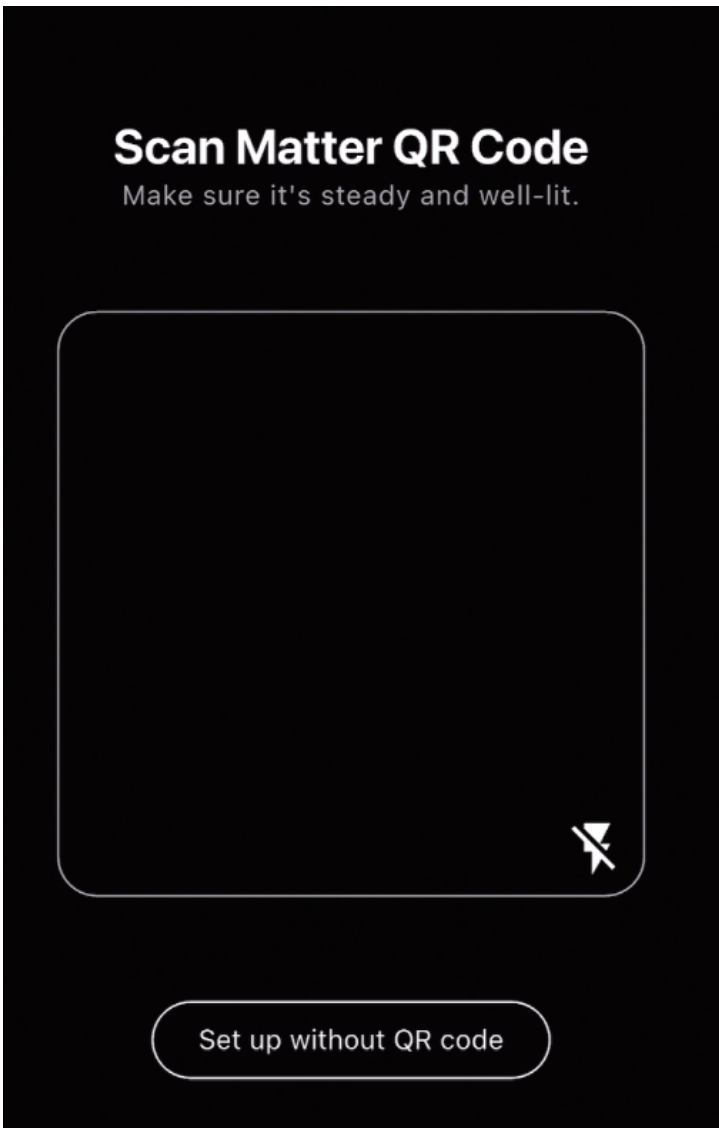
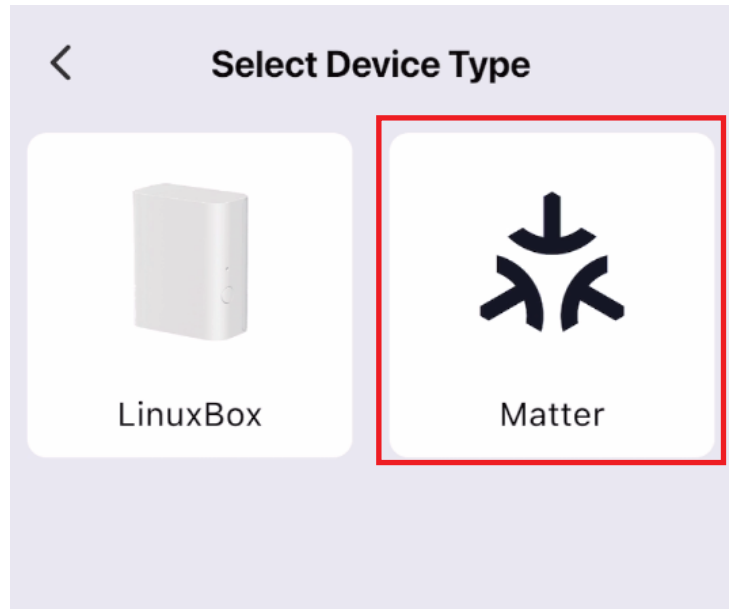
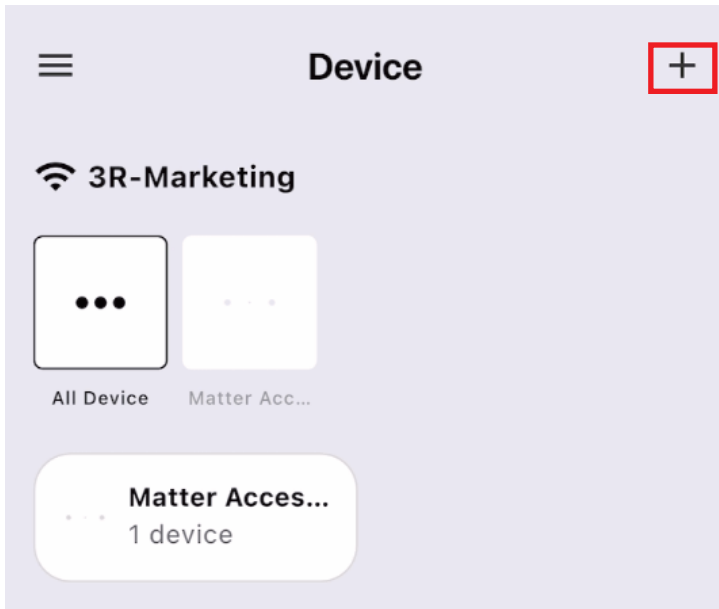

Pairing with Apple Home

Compatibility:

IOS system: Version 16.6 or later.

Matter-supported Controller: Home Pod, Home Pod mini, or Apple TV.



1. Launch your Home App. Tap+ and then tap Add or Scan Accessory to add a new device.
2. Scan the MATTER QR code on your device.
3. Choose a location and set a name for your device.
4. Now you can check your device on the Device list, turn on/off or create automation for your device on the Home app.
5. To connect the device to another MATTER certified ecosystem app, you need to go to the app of the first ecosystem to generate a new setup code. Go to the Device Settings page, scroll down, tap Turn On Pairing Mode and then Copy Code. Launch the app of another MATTER certified ecosystem, follow the setup instruction to enter the setup code and follow the app instructions to complete the setup.

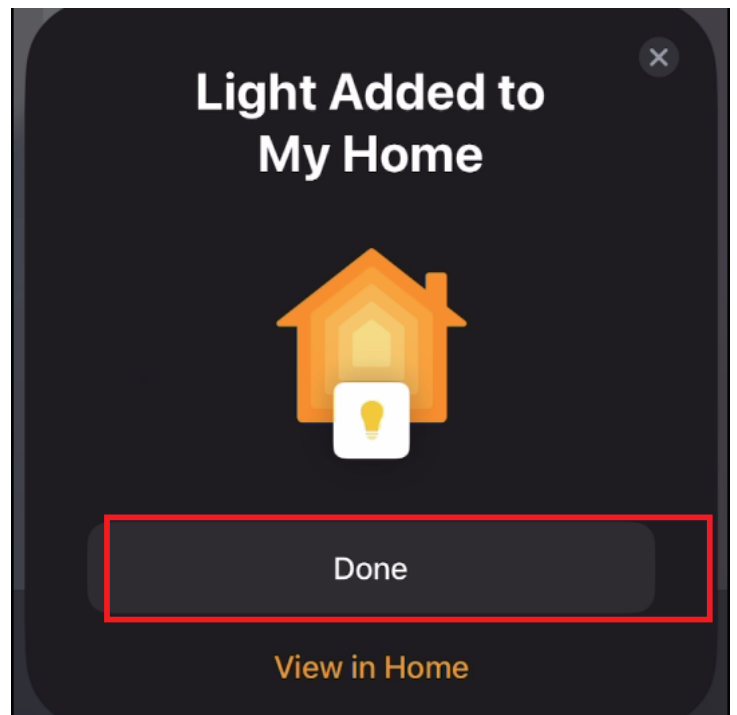
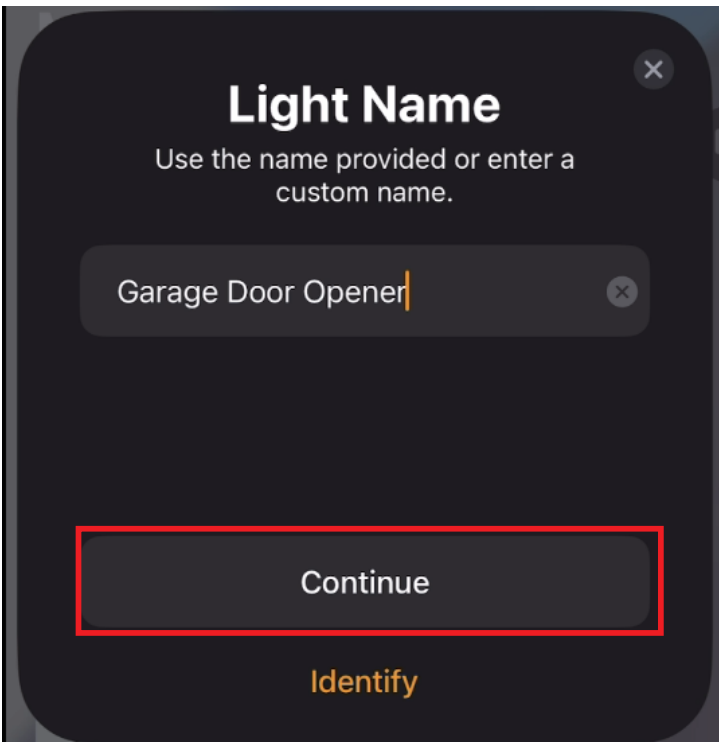
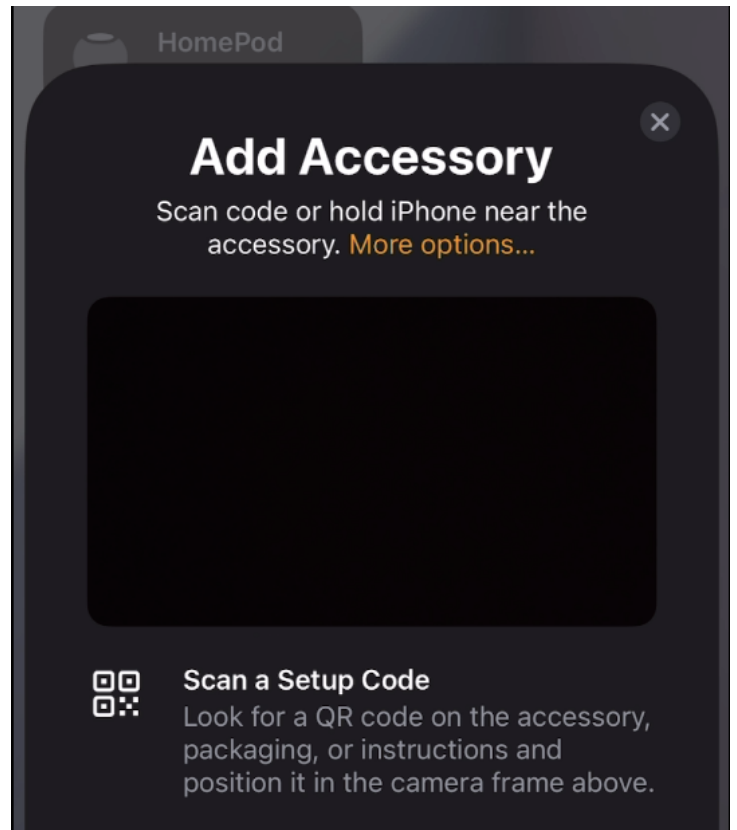
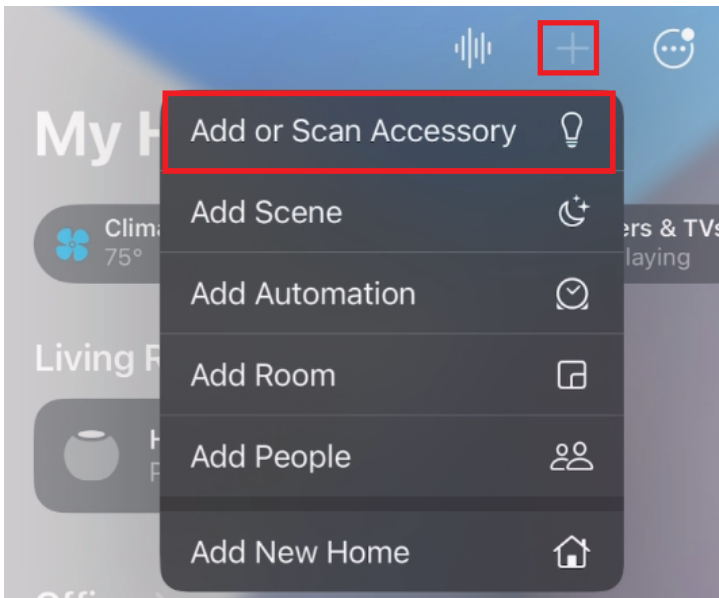

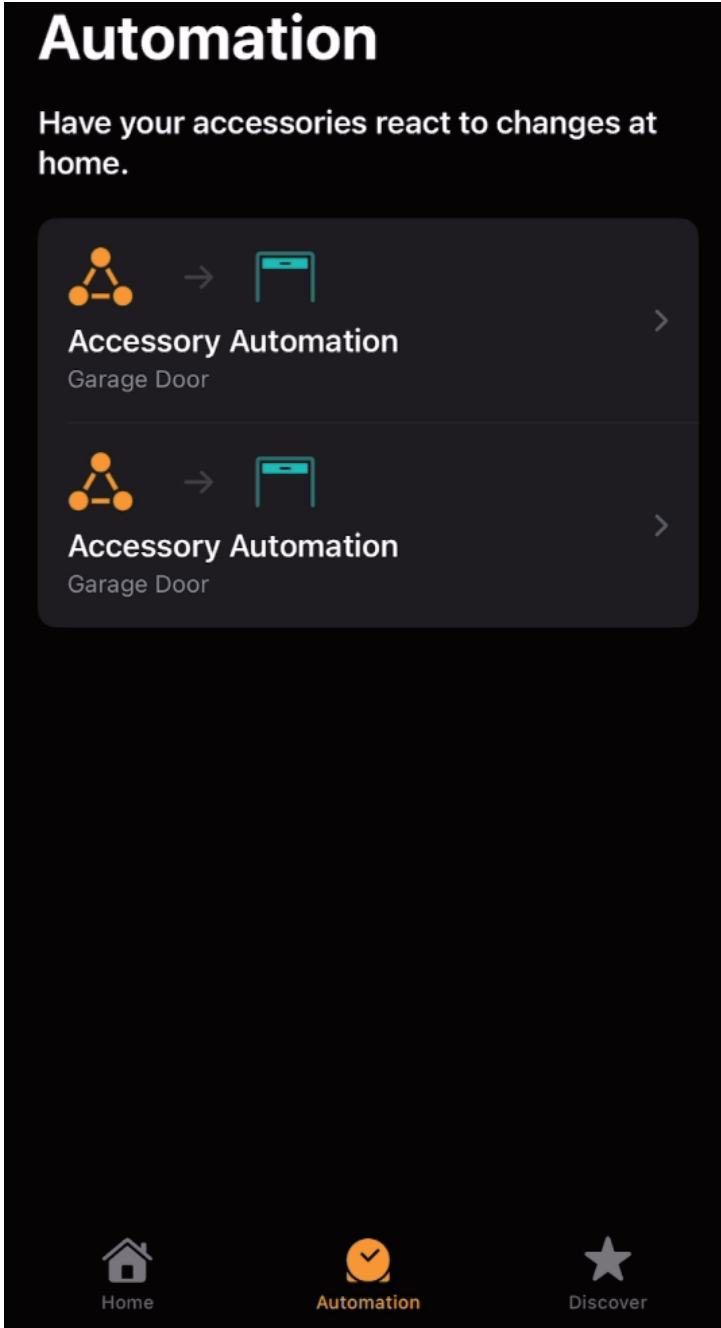
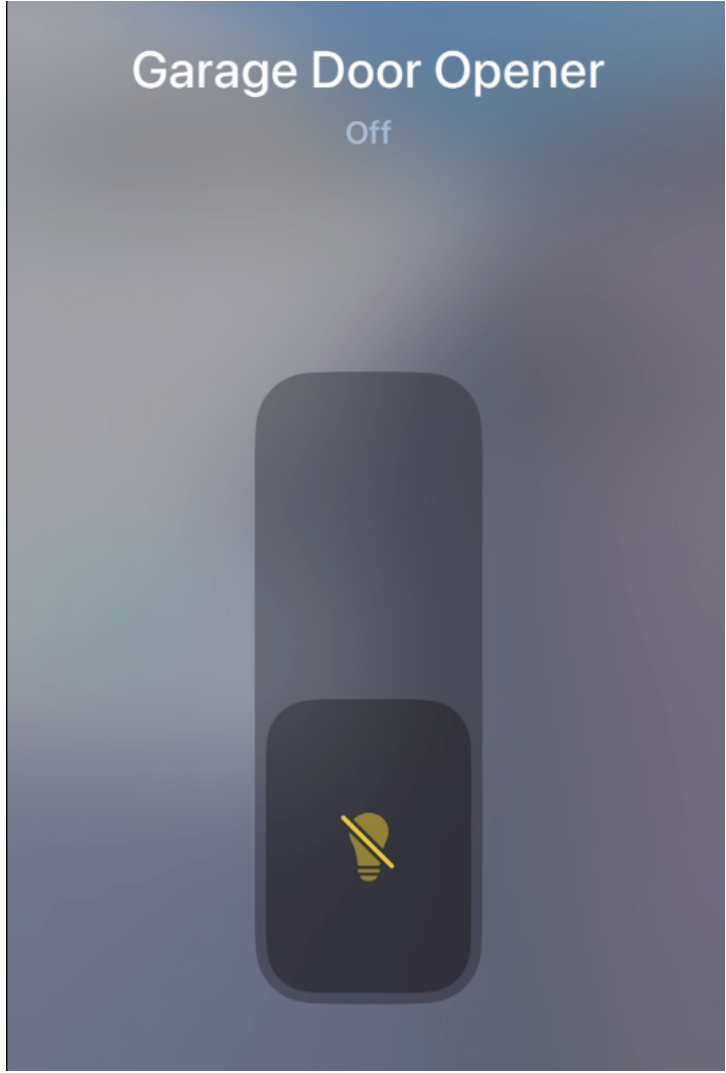
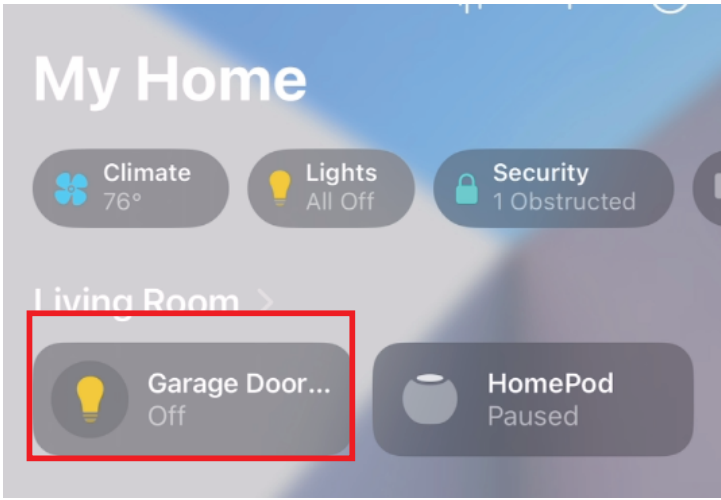

Pairing with SmartThings

Compatibility:

SmartThings App version

Android: 1.8.10.21 or later

IOS: 1.7.09 or later

Matter-supported Controller: SmartThings Hub V2& V3, Aeotec Smart Home Hub



Pairing steps:

1. Launch your SmartThings App. Tap + to Add device., choose Matter.
2. Scan QR code on your device.
3. Select a hub to connect your device.(You need to Add to “icloud Account” in IOS, then create Accessory Name, then Continue)
4. Now you can check your device on the Device list, turn on/off or create automation for your device.
5. To connect the garage door opener to another Matter ecosystem app, open the app of the first ecosystem the garage door opener has already been paired with, open the device page and tab the setting icon on the up right, then tap “Linked Matter apps & services” , and follow the app instructions to complete the setup.

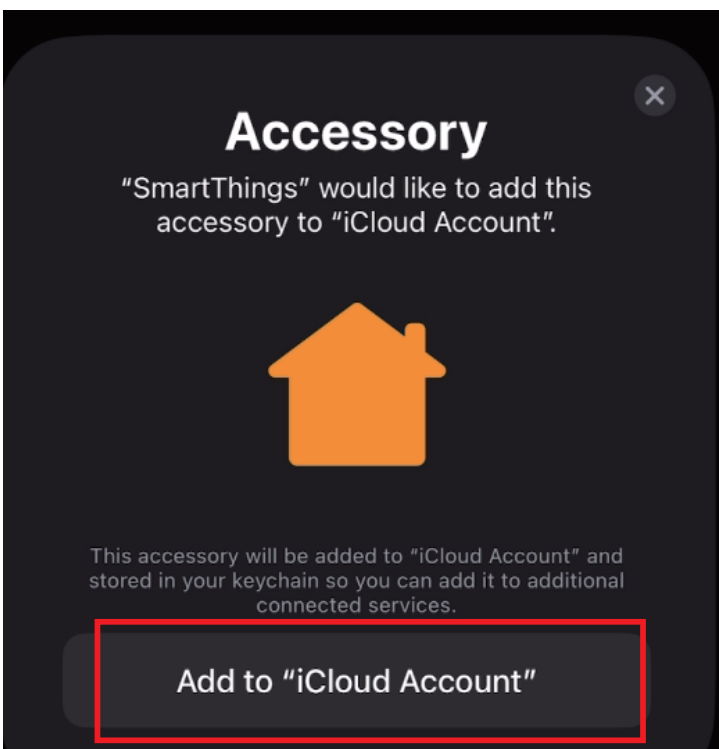
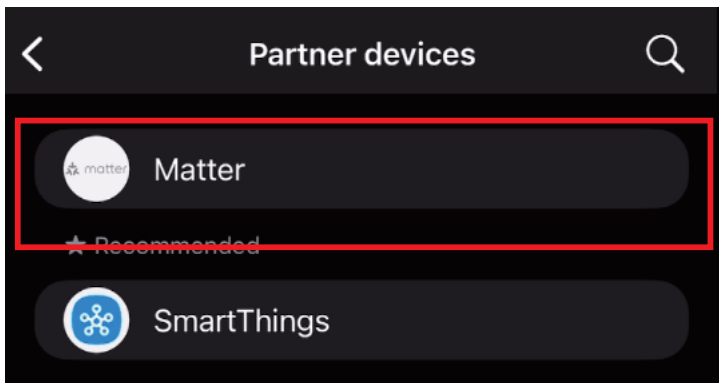
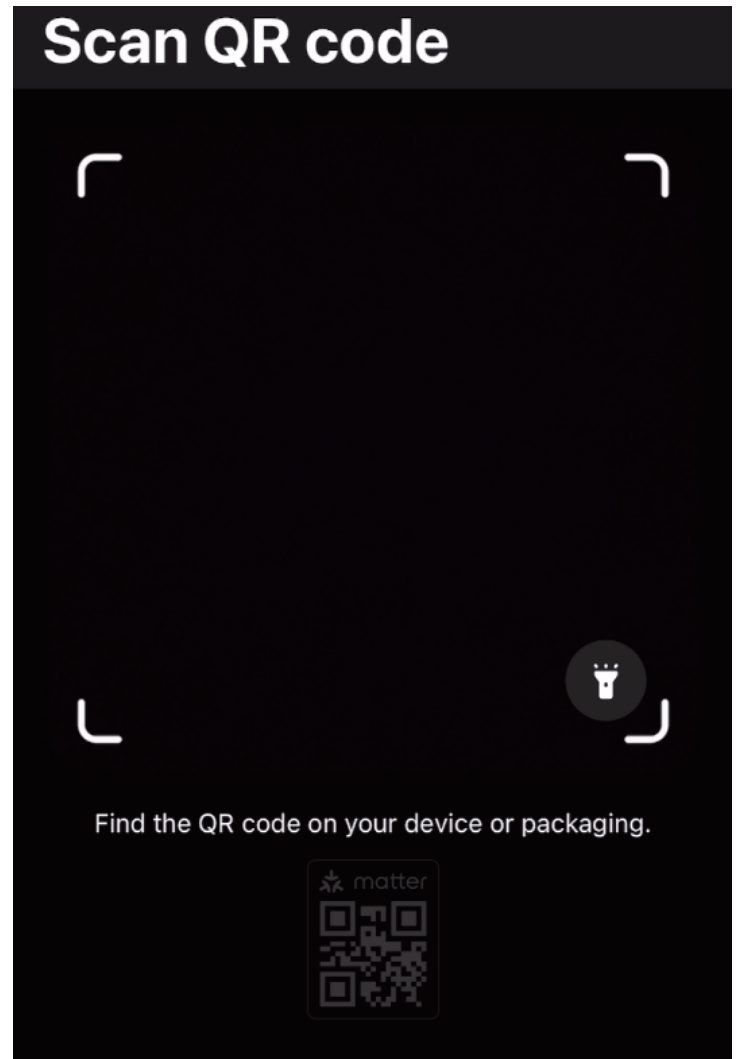
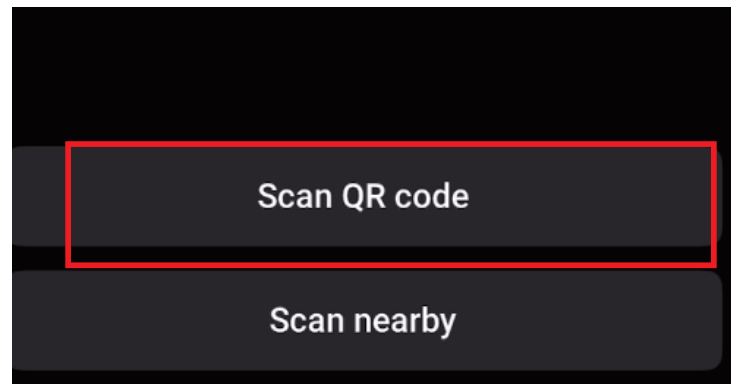
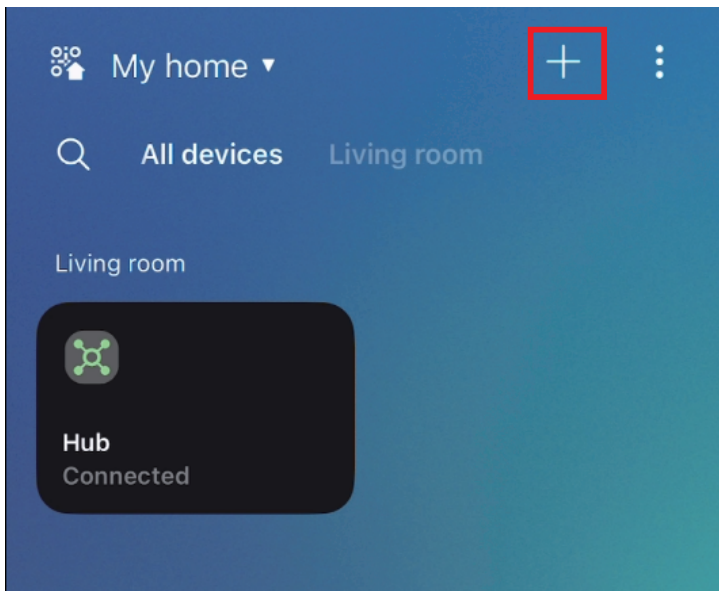

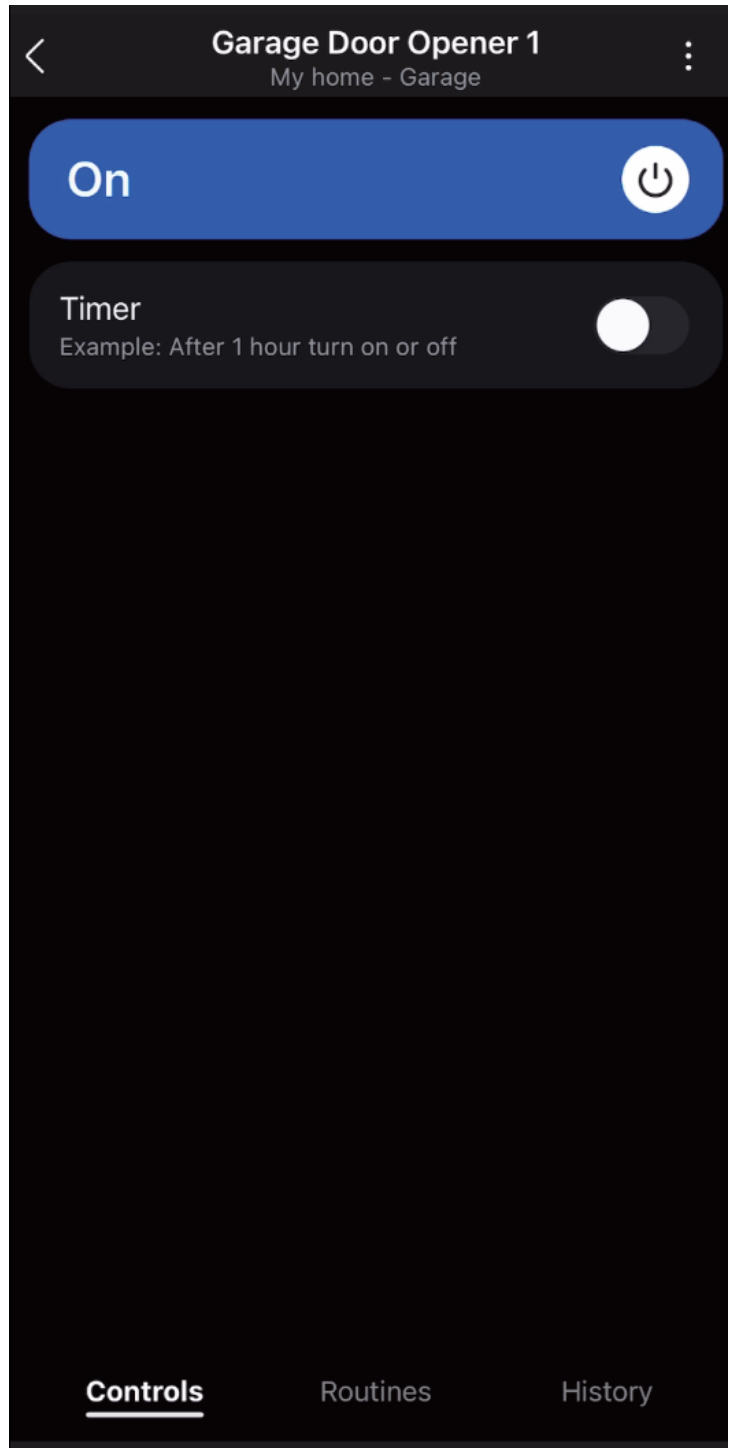
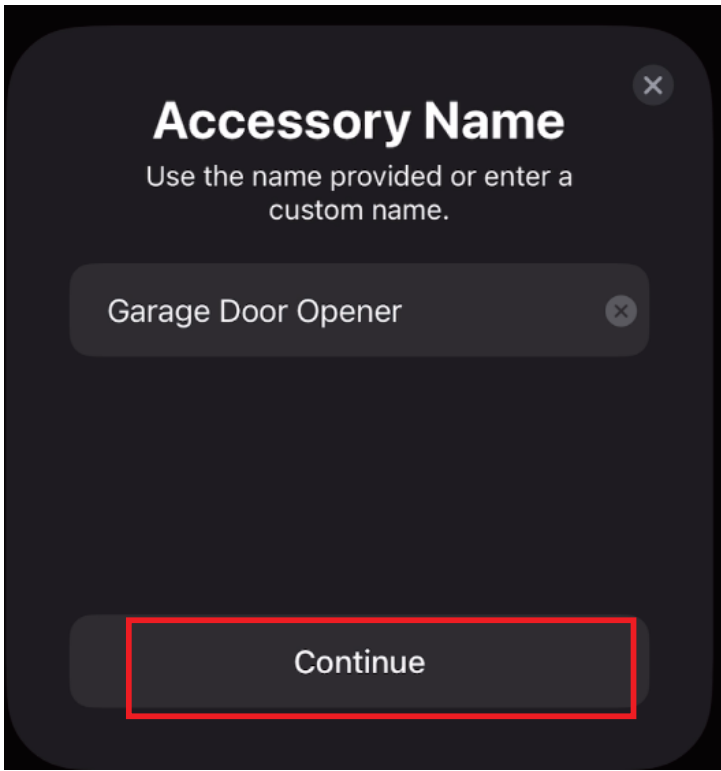

Pairing with Alexa

Alexa app version:

Android: 2.2.542657.0 or later

IOS: 2.2.575623.0 or later



Pairing steps:

1. Set up your Amazon Alexa Speaker, connect your phone to your WiFi router.
2. Power up the Smart Garage Door Opener, the blue LED flashes rapidly, indicating it is in pairing mode. If it is not in pairing mode, please press and hold the button on the Smart Garage Door Opener to perform a factory reset.
3. Open your Alexa app and sign in, tap + in the up right and follow the instructions to add device. Make sure to connect the device and the Echo Speaker to the same WiFi router.
4. Now you can check your device on the Device list, turn on/off or create automation for your device.
5. To connect the device to another MATTER certified ecosystem app, you need to go to the app of the first ecosystem to generate a new setup code. Go to the Device Settings page, scroll down, tap Turn On Pairing Mode and then Copy Code. Launch the app of another MATTER certified ecosystem, follow the setup instruction to enter the setup code and follow the app instructions to complete the setup.

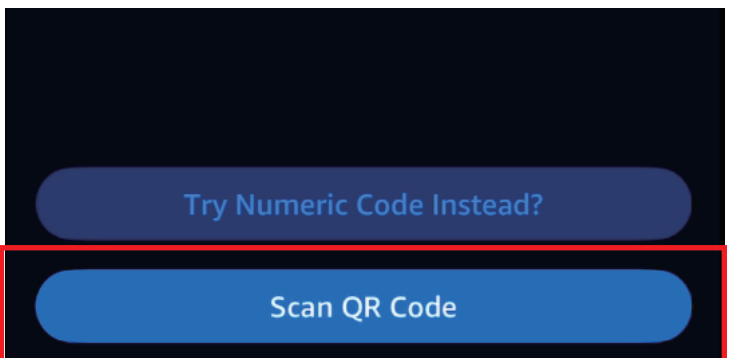
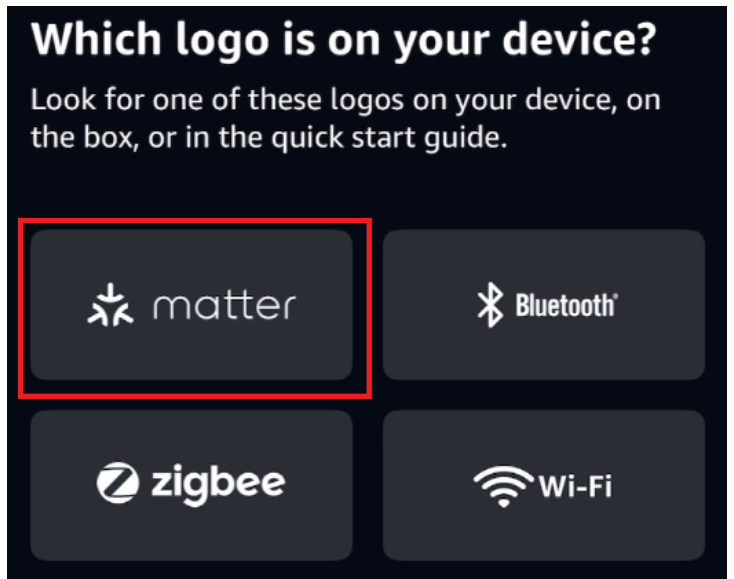
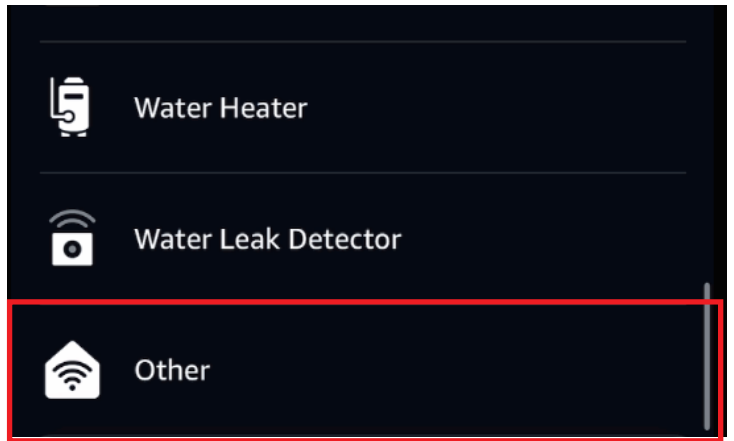
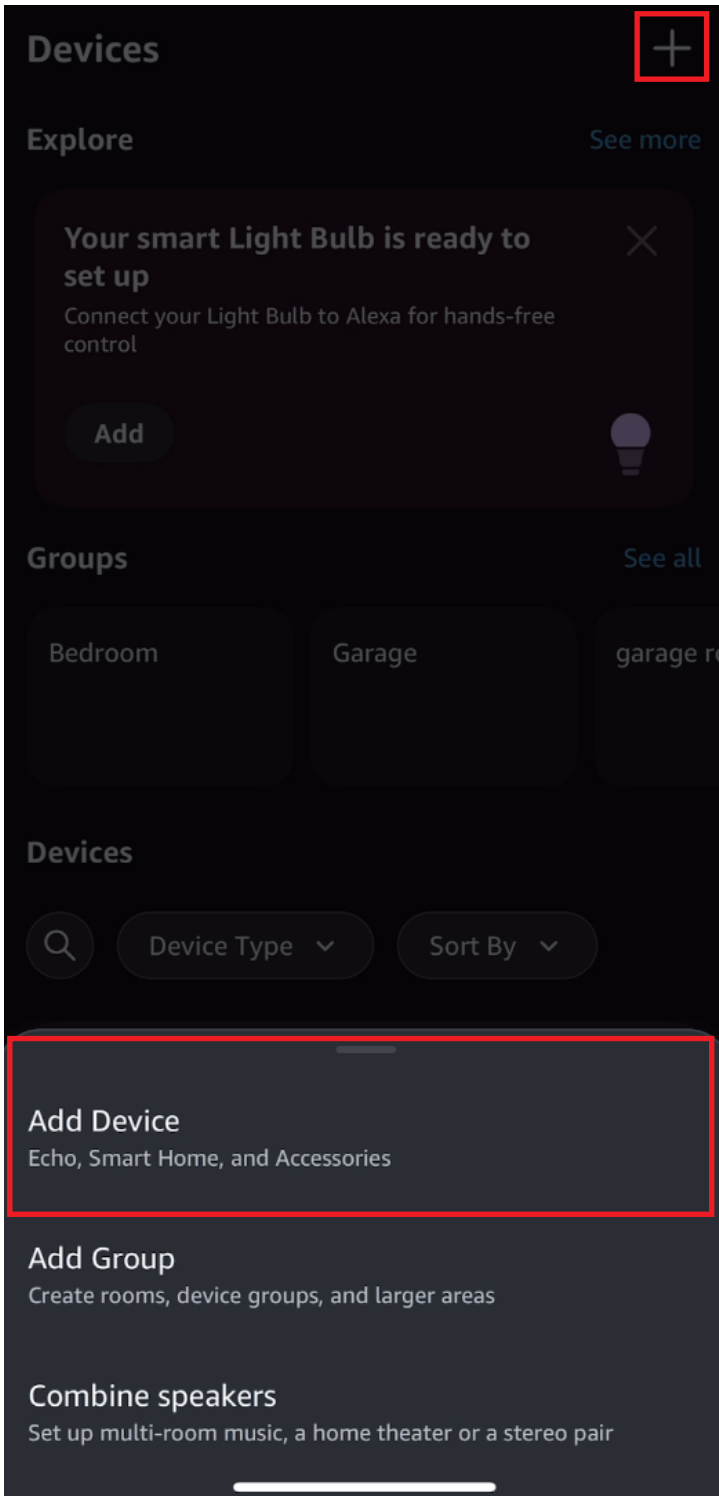



ThirdReality Light found and connected

Your device has been added to your Alexa account. Next, set the device up for easy use.

Next



Garage Door Opener is set up and ready to use

"Alexa, turn off Garage Door Opener"

Done

Devices



Device Type ▾

Sort By ▾



Garage Door Opener

• Recently added



First device



Garage Door Opener



Power is Off



Explore Smart Home features



Pairing with Google Home

Compatibility:

Google Home App version:

Android: 3.9.1.6 or later

IOS: 3.9.104 or later



Pairing steps:

1. Set up your Google Home Speaker in your Google Home app, connect your phone to your WiFi router.
2. Power up the Smart Garage Door Opener, the blue LED flashes rapidly, indicating it is in pairing mode. If it is not in pairing mode, please press and hold the button on the Smart Garage Door Opener to perform a factory reset.
3. A notification “Set up your device” pops up in your Google Home app, tap “Scan QR code” and follow the instructions to add the garage door opener.
4. Now you can check your device on the Device list, turn on/off or create automation for your device.
5. To connect the garage door opener to another Matter ecosystem app, open the app of the first ecosystem the garage door opener has already been paired with, open the device page and tap the setting icon on the up right, then tap “Linked Matter apps & services” , and follow the app instructions to complete the setup.

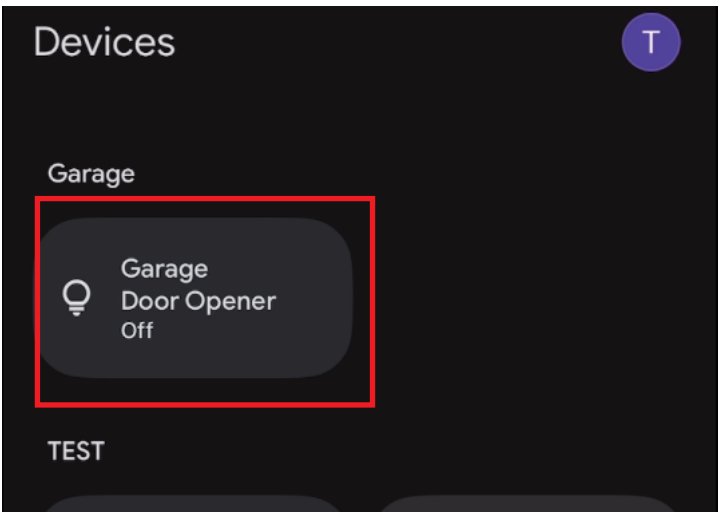
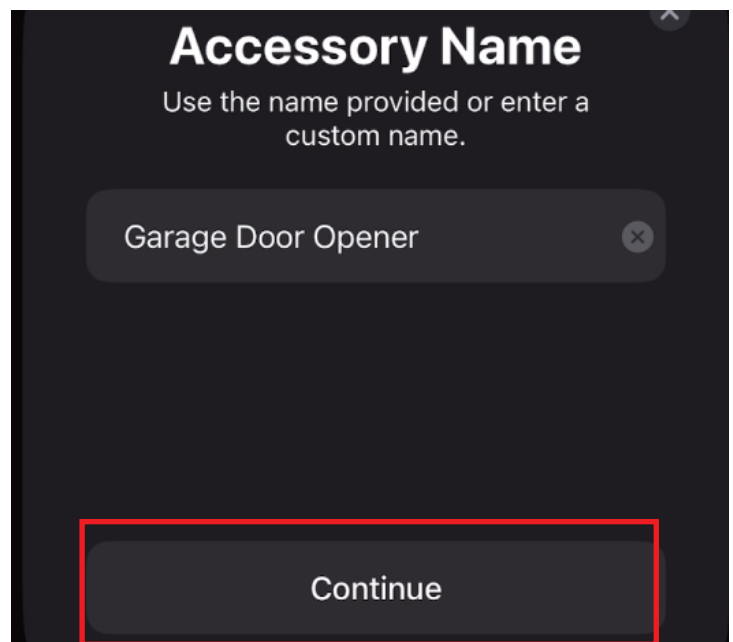
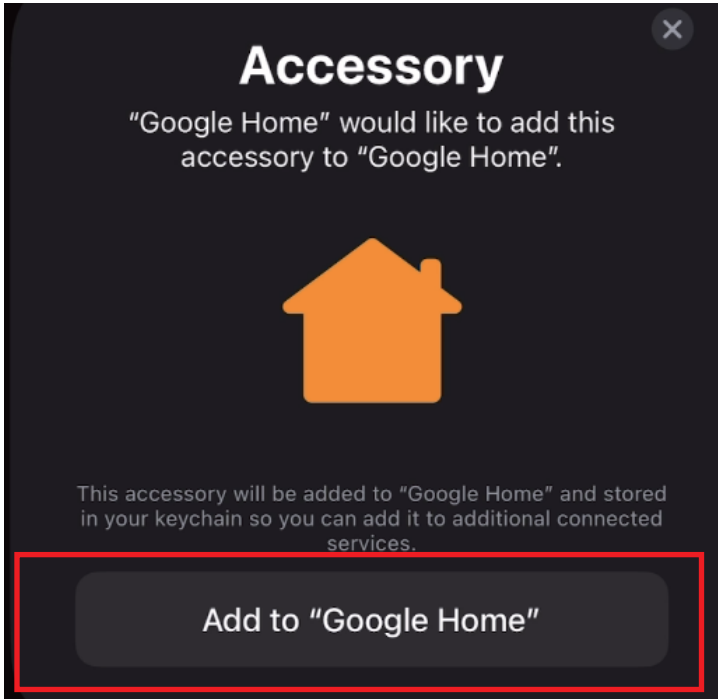
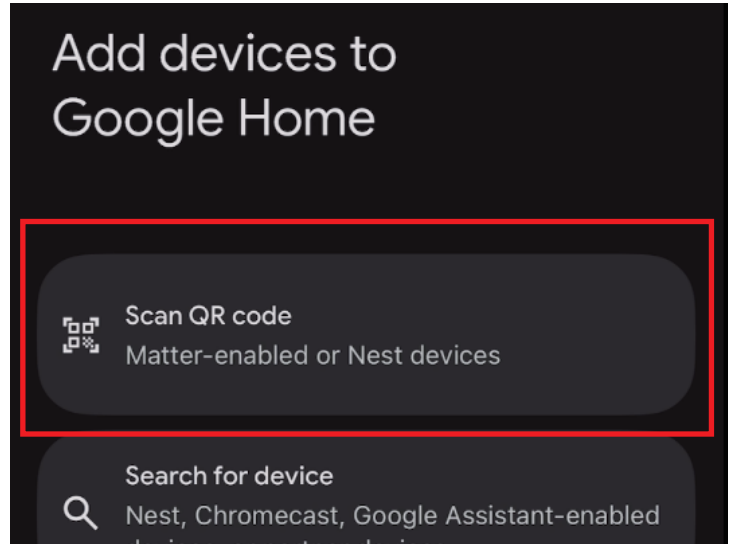
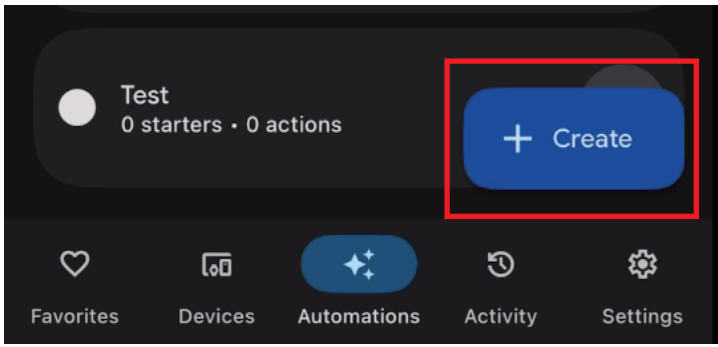

Pairing With Home Assistant

Compatibility: Home Assistant with Matter integration



Zigbee Home Automation

1. Power up the Smart Garage Door Opener, the blue LED flashes rapidly, indicating it is in pairing mode. If it is not in pairing mode, please press and hold the button on the Smart Garage Door Opener to perform a factory reset.
2. Use the Home Assistant App on your phone, go to Settings → Devices & Services, Click “+ Add Integration”, select “Matter”, and follow the instructions to add the garage door opener by scanning the QR code.
3. Once paired, the device will show up in your HA dashboard under “Devices”. You can also create automation for your device.
4. To connect the garage door opener to another Matter ecosystem app, open the app of the first ecosystem the garage door opener has already been paired with, open the device page and tap the setting icon on the up right, then tap “Linked Matter apps & services”, and follow the app instructions to complete the setup.

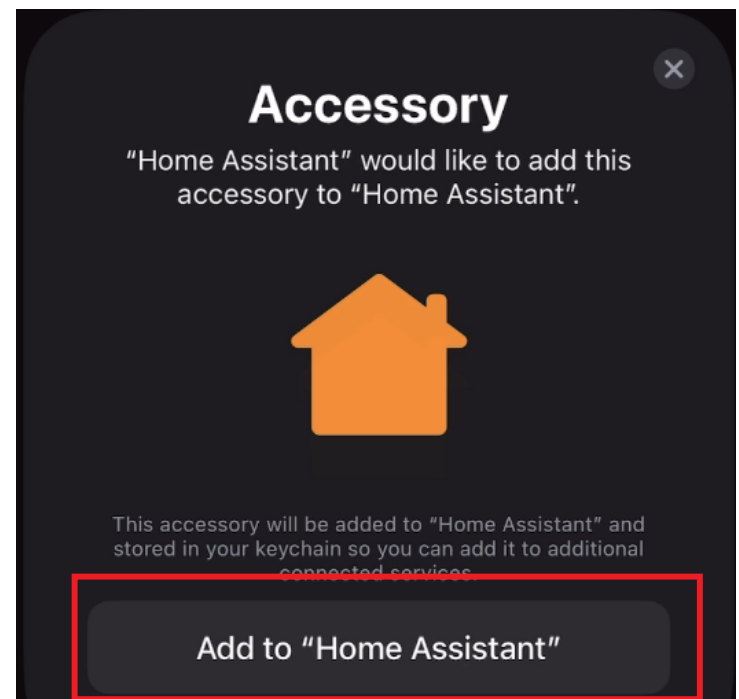
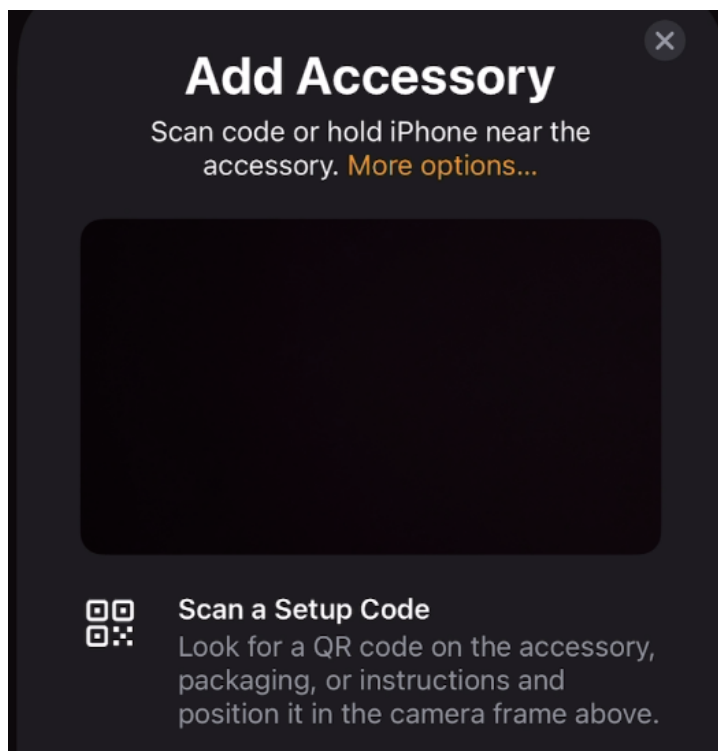
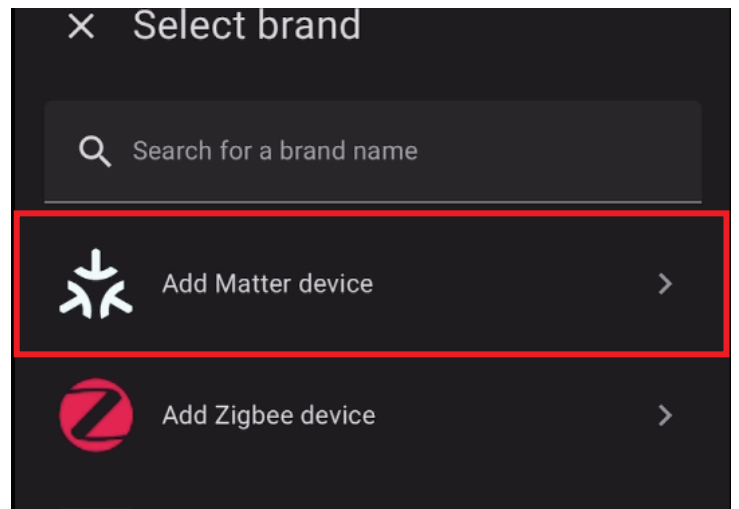
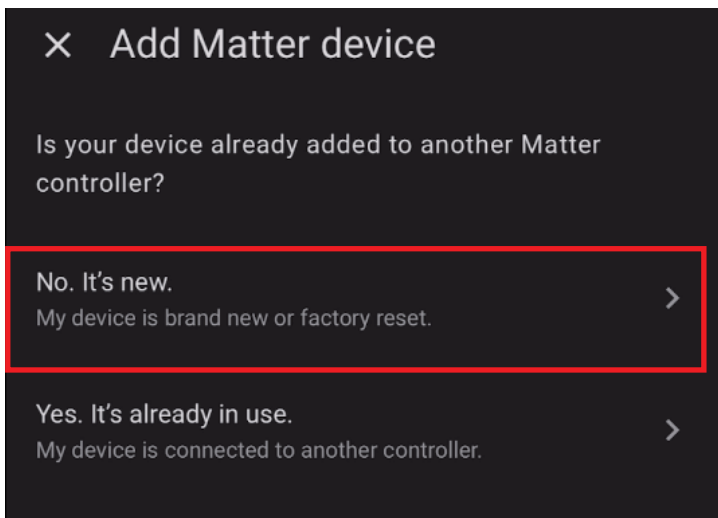
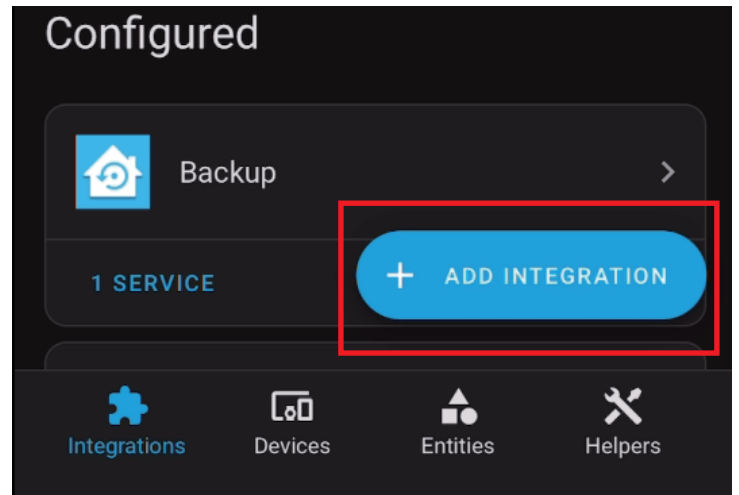
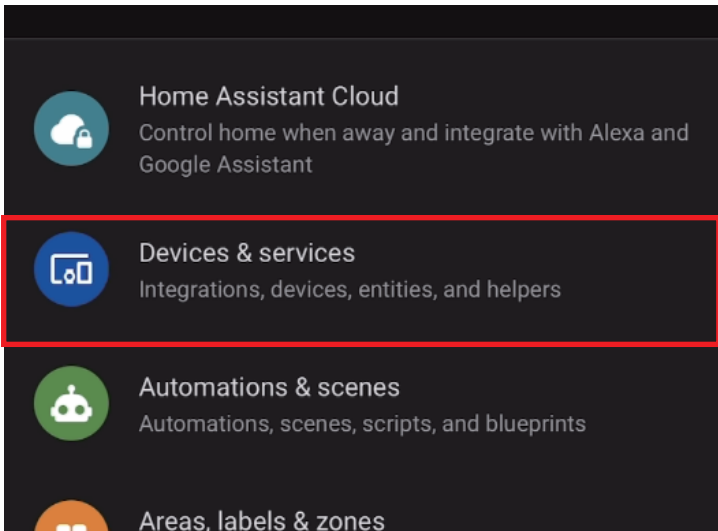

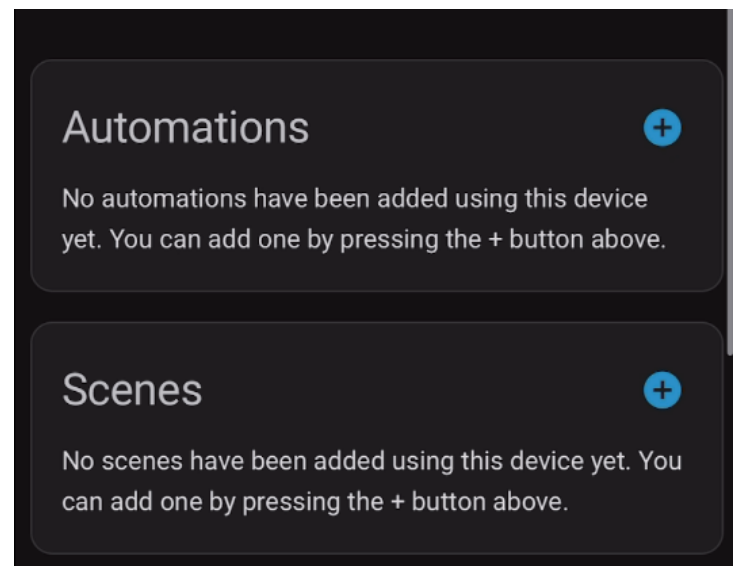
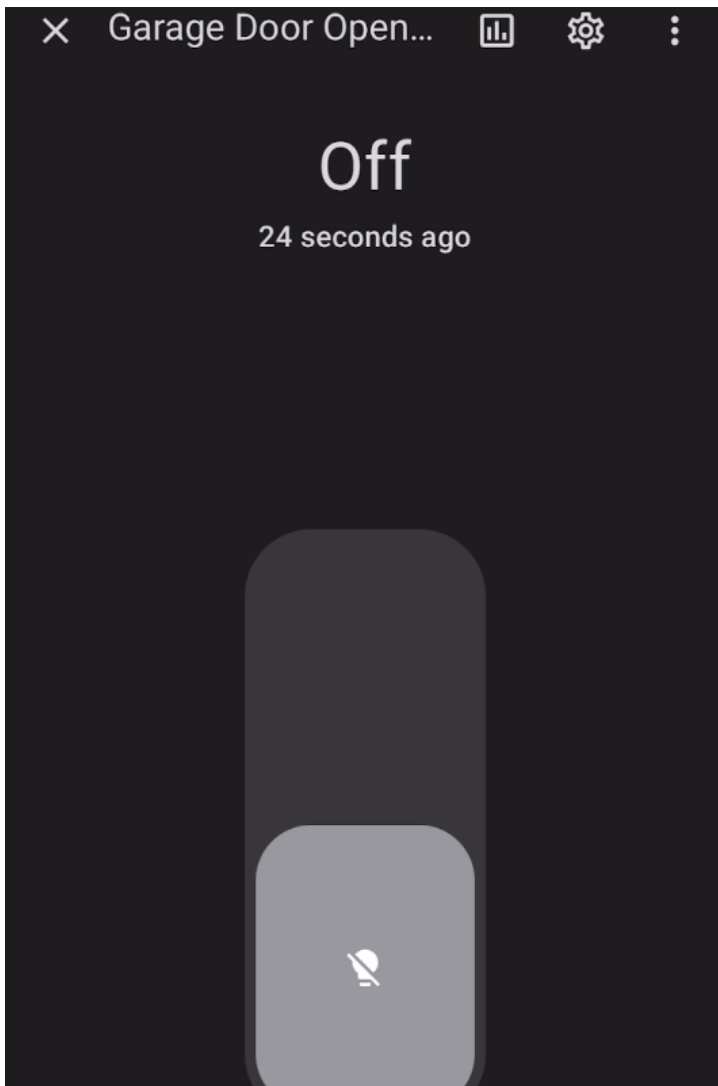
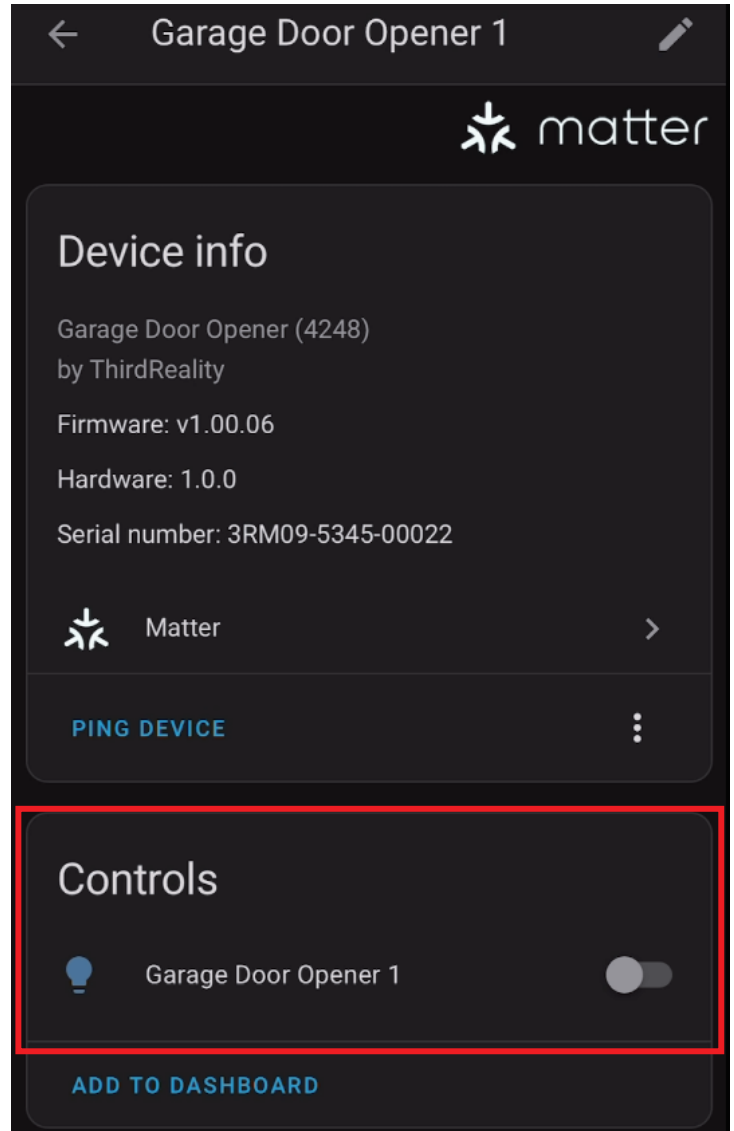
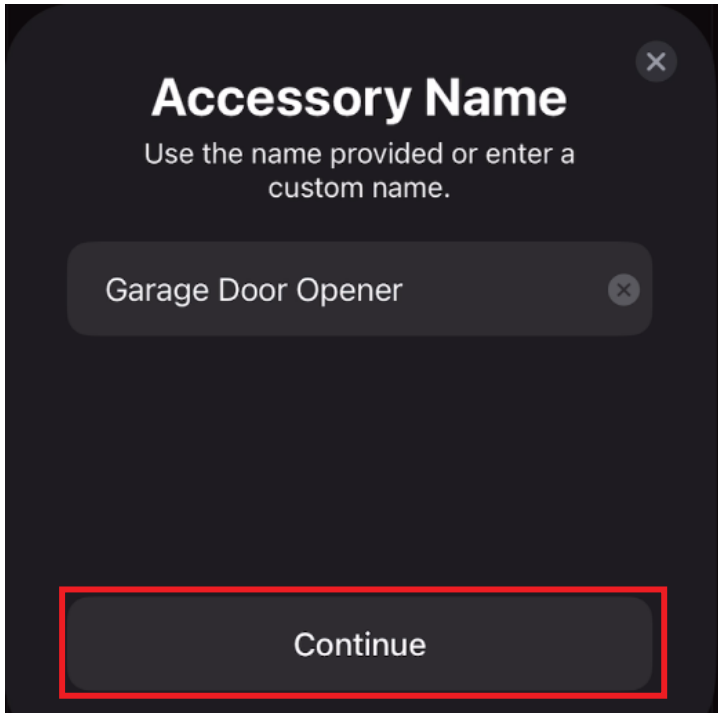

Troubleshooting

1. How to perform a factory reset?

Press and hold the top button on the Smart Garage Door Opener for 5 seconds until the red LED lights up, then release it. The device will reset and automatically enter pairing mode.

2. How to change or delete the Garage Door Tilt Sensor?

Use the 3R-Installer App to detach the paired sensor and then add a new one. Only one sensor can be paired at a time.

3. Does the Smart Garage Door Opener support only 2.4 GHz Wi-Fi?

Yes, it only connects to 2.4 GHz networks and does not support 5 GHz.

FCC Regulatory Conformance

This device complies with part 15 of the FCC rules. Operation is subject to the following two conditions: (1) this device may not cause harmful interference, and (2) this device must accept any interference received, including interference that may cause undesired operation.

Changes or modifications not expressly approved by the party responsible for compliance could void the user's authority to operate the equipment.

NOTE: This equipment has been tested and found to comply with the limits for a Class B digital device, pursuant to part 15 of the FCC Rules. These limits are designed to provide reasonable protection against harmful interference in a residential installation.

This equipment generates uses and can radiate radio frequency energy and, if not installed and used in accordance with the instructions, may cause harmful interference to radio communications. However, there is no guarantee that interference will not occur in a particular installation. If this equipment does cause harmful interference to radio or television reception, which can be determined by turning the equipment off and on, the user is encouraged to try to correct the interference by one or more of the following measures:

- Reorient or relocate the receiving antenna.
- Increase the separation between the equipment and receiver.
- Connect the equipment into an outlet on a circuit different from that to which the receiver is connected.
- Consult the dealer or an experienced radio/TV technician for help important announcement.

NOTE: The manufacturer is not responsible for any radio or TV interference caused by unauthorized modifications to this equipment. Such modifications could void the user's authority to operate the equipment.

RF Exposure

This equipment complies with FCC radiation exposure limits set forth for an uncontrolled environment.

This equipment should be installed and operated with minimum distance 20cm between the radiator and your body.

This transmitter must not be co-located or operating in conjunction with any other antenna or transmitter.

Limited Warranty

For limited warranty, please visit <https://3reality.com/faq-help-center/>
For customer support, please contact us at info@3reality.com or visit www.3reality.com.

For questions on other platforms, visit the corresponding platform's application/support platform.