

INSTRUCTION MANUAL V2

SLIM33

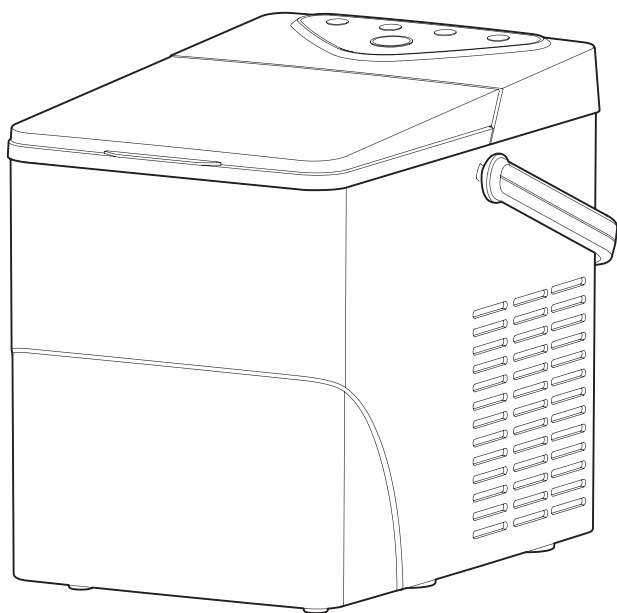

Ice Maker



IMPORTANT SAFETY INFORMATION	01
PRODUCT INTRODUCTION	04
CONTROL PANEL INTRODUCTION	05
USING YOUR ICE MAKER	06
CLEANING AND MAINTENANCE	10
PRODUCT SPECIFICATIONS	13
TROUBLESHOOTING	14
WARRANTY INFORMATION	17

IMPORTANT SAFETY INFORMATION

To reduce the risk of injury or property damage, please follow these safety precautions.



WARNING



- Voltage power from outlet must match specifications on appliance nameplate.



- This appliance **must be** grounded.



- Using an extension cord may cause overheating and increase the risk of fire.

If an extension cord **MUST** be used:

- 1) **Only use an** extension cord with grounding plug.
 - 2) The marked rating of an extension cord **must be** equal to or greater than the rating of this appliance.
- **Do not** operate if any component, including the cord or plug, is damaged.
 - Unplug the unit before cleaning by hand.



- Only responsible and capable adults should operate the ice maker.
- **Do not** place the power cord where it could be pulled by children or pose a tripping hazard.
- Children should not be left unattended near the ice maker during operation.



- **Do not** use water that is micro-biologically unsafe or of unknown quality.



- **Do not** remove any safety, warning, or product information labels from the unit.



- **Do not** touch the evaporator with your hands while the ice maker is operating.
- **Do not** plug in or unplug the unit with wet hands.



- **Never** put flammable, explosive and corrosive articles into the ice maker.



- The unit **must be** placed and set up according to installation instructions before use. The unit is for indoor household use only.



- **Do not** store or use flammable vapors or liquids near the unit.
- **Do not** immerse any part of the unit in water.



- **Do not** attempt to disassemble, repair, modify or replace any part of the ice maker unless permitted by the manufacturer.



WARNING

- **DANGER** - Risk of FIRE or EXPLOSION. Flammable refrigerant used. **Do not** use mechanical devices to defrost the Ice Maker. **Do not** puncture refrigerant tubing.
- **CAUTION** - Risk of FIRE or EXPLOSION. Flammable refrigerant used.
- **CONSULT** repair Manual/Owner's guide before attempting to install or service this product. All safety precautions must be followed.
- **CAUTION** - Risk of FIRE or EXPLOSION. Flammable refrigerant used. Dispose of property in accordance with federal or local regulations.
- **CAUTION** - Risk of FIRE or EXPLOSION due to puncture of refrigerant tubing. FOLLOW Instructions Carefully. Flammable Refrigerant used.
- **WARNING:** When positioning the appliance, ensure the supply cord is not trapped or damaged.
- **WARNING:** Do not locate multiple portable socket-outlets or portable power supplies at the rear of the appliance.



1. When handling, installing, and operating the unit, care should be taken to avoid damage to the refrigerant tubing.



2. Keep ventilation openings around the unit's enclosure clear of obstruction.



3. **Do not** place the unit near heat sources such as an oven.



4. Ensure a minimum of 6" of clearance around the side and back walls of the unit for proper air circulation.



5. **Do not** place the unit in direct sunlight.



6. Risk of fire or explosion. Flammable refrigerant used.
Do not use mechanical devices to defrost the unit.
Do not puncture or damage refrigerant tubing.



7. Only dispose of the unit according to Federal and Local Regulations. Contact your local authorities for the environmentally-safe disposal of the unit.



ATTENTION

- The ice maker parts should be replaced with parts that have the same specifications and the maintenance should be done by authorized service personnel, to minimize the risk of fire hazards due to incorrect parts or improper operation.
- The ice maker should be installed in accordance with the Safety Standard for Refrigeration Systems, ASHRAE 15.
- The ice maker should not be installed in hallways or corridors of public buildings.

SAVE THESE INSTRUCTIONS.

PRODUCT INTRODUCTION

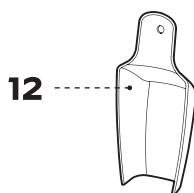
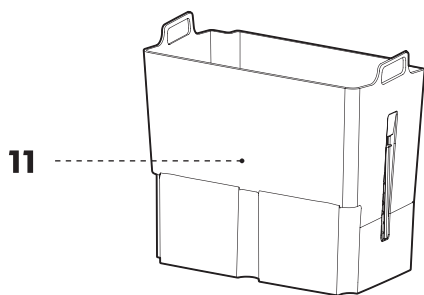
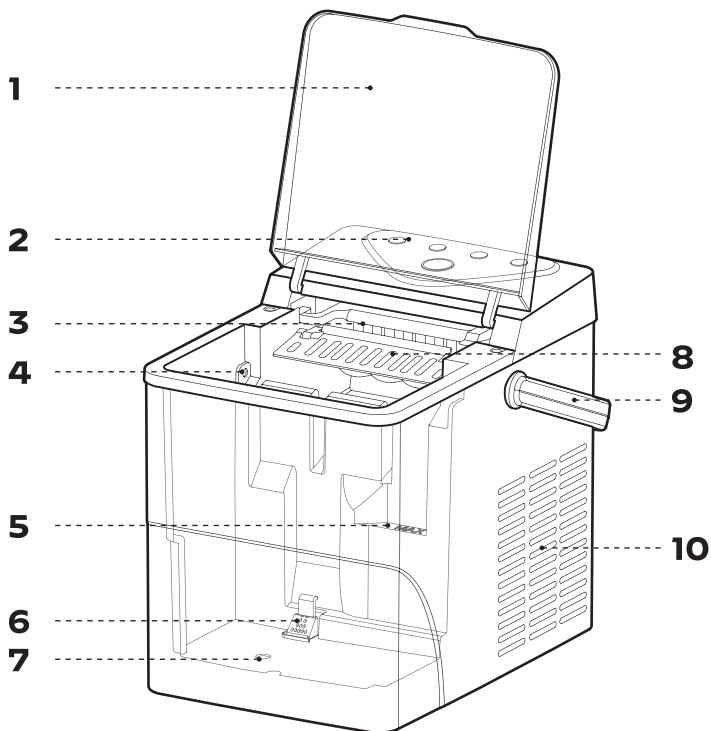

1. Large Viewing Window

2. Control Panel

3. Evaporator

4. Ice Full Sensor

5. Maximum Water Fill Line

6. Water Filter

7. Drain Plug

8. Ice Shovel

9. Handle





10. Air Exhaust Fan

11. Ice Basket

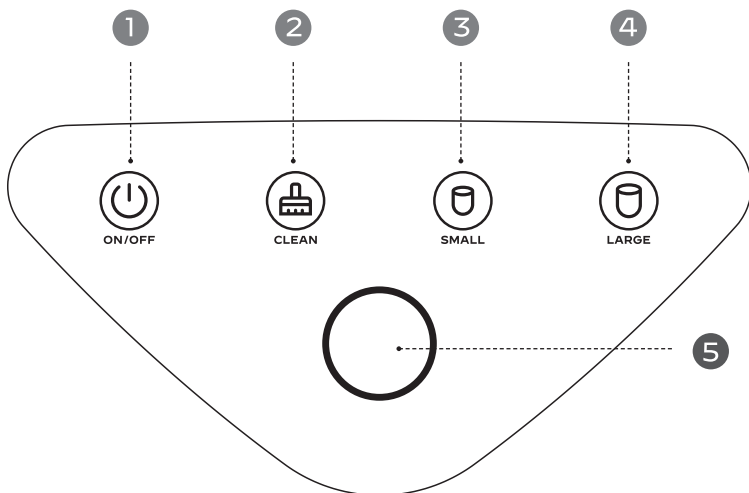
12. Ice Scoop

CONTROL PANEL INTRODUCTION



	Button (with Indicator)	Function
1	 ON/OFF	Press the ON/OFF button to enter standby mode. The indicator will turn on.
		In ice-making or self-cleaning cycle, press the ON/OFF button to turn the ice maker off.
2	 CLEAN	In standby mode, press the CLEAN button to enter self-cleaning mode. The indicator will turn on.
3	 SMALL	Press this button to select small cubes. The unit will start to make ice.
4	 LARGE	Press this button to select large cubes. The unit will start to make ice.
5	RING INDICATOR	The indicator turns faint white when the machine is in standby mode.
		The indicator turns white when the machine is making ice.
		The indicator turns green when the ice basket is full.
		The indicator turns red when the water tank is low.
		The indicator turns blue when the ice maker enters self-cleaning mode.

USING YOUR ICE MAKER

BEFORE FIRST USE

1.

Verify all parts and ice maker accessories were received.
Missing parts? Contact Customer Service.



Stand upright for 24hrs.

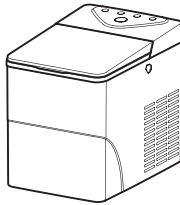

Use in locations
50°F ~ 90°F
(10°C ~ 32°C).

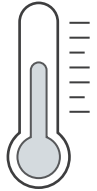

2. Installing The Handle

Position the handle over the holes, then press each side in to secure it.

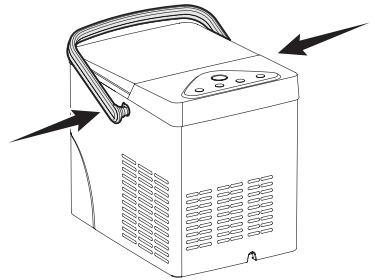

Lift back to lock the handle into place.

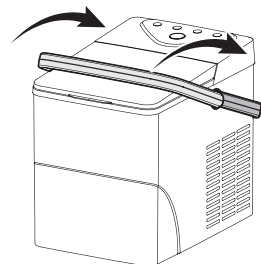

3.

Carefully **remove the protective film** and clean the ice maker thoroughly before first use.

Note: Make sure the drain plug is installed in place.

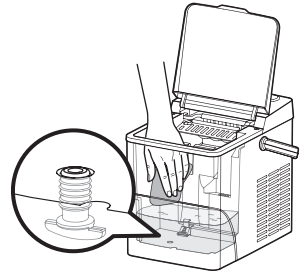

The evaporator drops 9 pcs of ice in each set. When using for the first time, or if the machine has not been used in a long time, please discard the first 4 sets of ice.



Due to temperature variations and other factors, ice quality should become stable after the first 1–3 cycles.

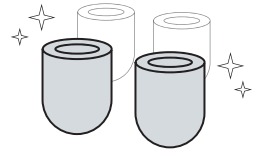

More Cycles = Perfect Shape

4. What Not To Do!

Unstable base.

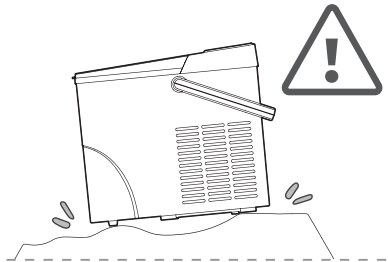

No other liquids
(Drinking water only).

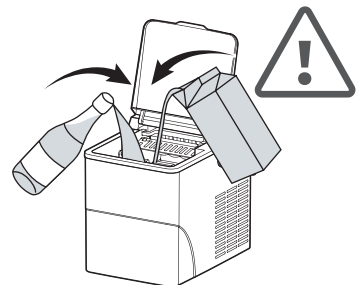

Do not use in high or low temps,
especially **lower than 41°F/5°C**.

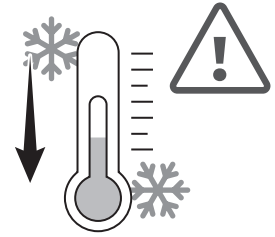

HOW TO USE YOUR ICE MAKER

1.

Open the cover and remove the ice basket.

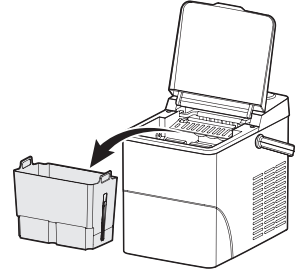

2.

Add water. Do not exceed the "MAX" water line. Otherwise, some ice cubes will be submerged in water when making ice. Then put the ice basket back into the machine.

Note: If you want to refill water during the ice-making process, empty the ice basket first.

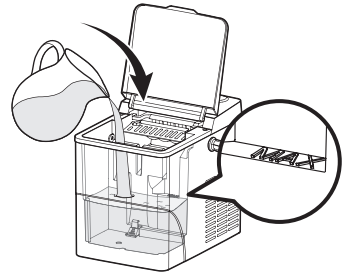

3.

Press the **ON/OFF** button to enter standby mode.

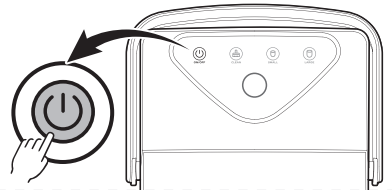

4.

Press the **SMALL** or **LARGE** button to select the ice cube size. The machine will start to make ice.

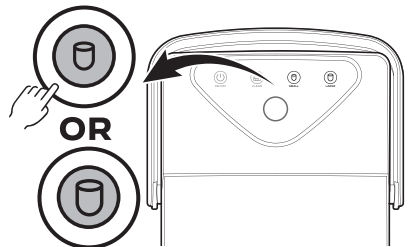

Tip: It is recommended to choose small ice mode when in low temperature.

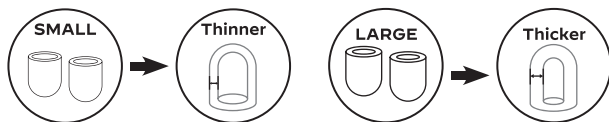

5.

Wait **6 min - 8 min**. Ice making time depends on room temp and water temp.

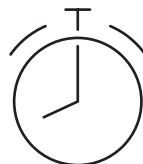

DONE:

The ring indicator turns green when the ice basket is full.

Note: See **TROUBLESHOOTING** for the solution in case of a false alarm of ice-full.

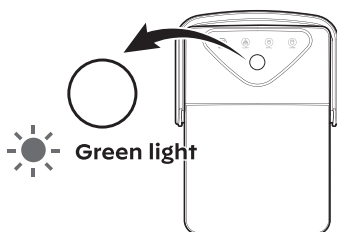

REFILL:

When the ring indicator turns red, add water and press the **SMALL** or **LARGE** button to restart.

Note: After refilling, the machine will automatically start after 5 mins without operation.

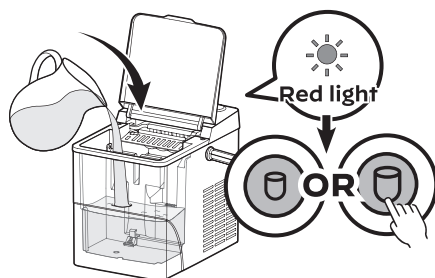

Remove ice cubes before they start to melt.

Some water may drip out when removing the ice basket. Use a dry towel to keep water from dripping on surfaces.

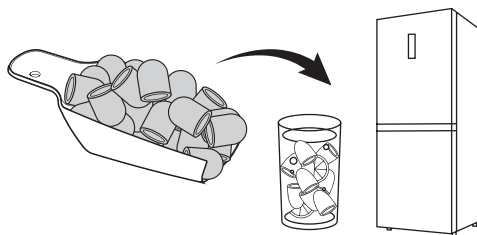

Note: After accidental power-off, it takes a little more time to restart the ice maker.

CLEANING AND MAINTENANCE

To keep your ice tasting fresh and the unit looking great, we recommend cleaning the unit once per week.

SELF-CLEANING (5-MIN PROCESS)

1.

Remove the basket and add water or water/vinegar mixture in a ratio of 5:1 to the water tank.

Note: In areas with hard water, professional ice maker detergent can be used to clean the ice maker. Leave the detergent in the machine for 12 hours.

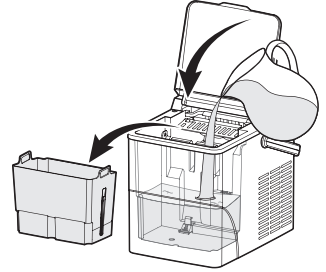

2.

IN STANDBY MODE:

Press the **CLEAN** button to start self-cleaning.

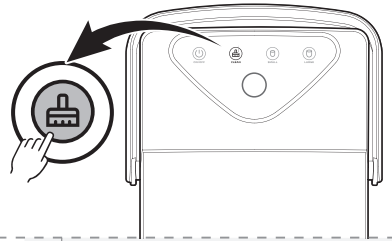

3.

Drain excess water over sink.

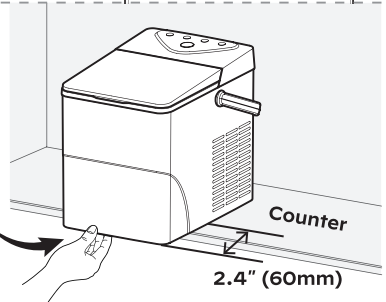
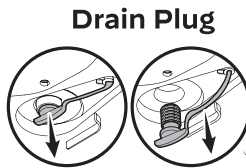

4.

Clean the ice basket with warm water, then put it back into the machine.

Wipe the exterior with a cloth using mild dishwashing soap.



MANUAL CLEANING

Turn off the unit and disconnect from power before cleaning.

1.

Add water/vinegar mixture in a ratio of 5:1, then leave in the water tank for a period of time. Clean the water filter, the ice outlet, the ice basket, and other small corners to prevent dirt buildup.

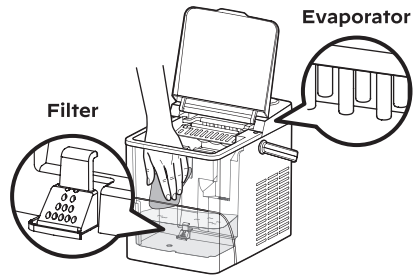

2.

Drain excess water over sink.

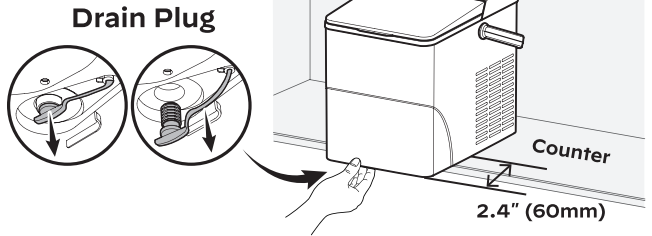

3.

Clean the ice basket with warm water, then put it back into the machine. Wipe the exterior with a cloth using mild dishwashing soap.

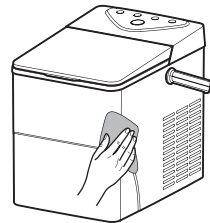

DISASSEMBLING THE ICE BASKET

1.

Press the clip inward from the outside.

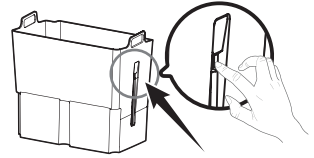

2.

When pressing the clip, lift the ice basket out from the inside. Repeat the steps to unlock the other side.

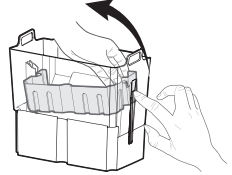

3.

Remove the springs on both sides.

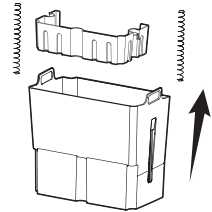

INSTALLING THE ICE BASKET

1.

Insert both springs back into place.

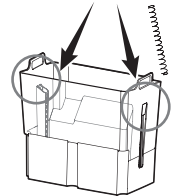

2.

Align one clip with the slot, then slide it down. Press to lock it into place. Repeat the steps to install the other side.

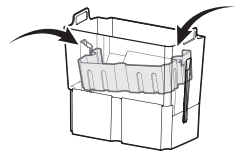

3.

Check to see if the basket is installed and the springs work properly.

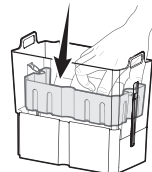

⚠ DO's & DON'Ts while cleaning and maintaining

- **Do not** use organic solvent, boiled water, strong acid and strong alkali etc. for cleaning. This will cause corrosion of the evaporation column.
- When cleaning the evaporator, be careful to keep the vertical prongs level. If the prongs are not level, the ice cubes may stick together during use.
- Considering the wide range of water quality across different regions, it is recommended to perform regular manual cleaning.
- Limescale can easily form if the ice basket is submerged in water for a long period of time. Drain water if the machine is not in use.
- It is recommended to **drain the water tank** at least once every three days.
- When the unit is not to be used for a long duration, **drain** the water completely & dry the interior.
- **Store** in a well-ventilated area.

PRODUCT SPECIFICATIONS

Voltage/Frequency	120V/60Hz
Working Power	≤ 160W
Electric Current	2.2A
Water Tank	0.48 gal (1.8L)
Ice-Making Rate	26 lbs (11.8kg) per Day
Ice Shape	Bullet
Ice Size	Small or Large
Material	ABS, PP
Unit Size	13.2 x 9.1 x 12" (335 x 230 x 306mm)

TROUBLESHOOTING

Problem	Possible Causes	Solution
Poor ice shape or quality.	Poor heat dissipation.	Leave a 6" clearance on all sides of the ice maker for ventilation.
	The water temperature is too high.	Fill with water temperatures between 46°F and 77°F.
	The ambient temperature is too high.	Use the ice maker in room temperatures between 50°F and 90°F.
	Evaporator deformation.	Please contact customer service.
The ring indicator turns red.	Low water level or not enough water.	Stop making ice, refill water, then press the SMALL or LARGE button to restart. Or wait 5 mins for the machine to restart automatically.
	Water screen blocked at the bottom of the water tank.	Run the self-cleaning program.
	Water sensor malfunction.	Power off for 2 minutes and restart the machine.
	Pump malfunction.	Please contact customer service.

Problem	Possible Causes	Solution
<p>The ring indicator turns green.</p>	<p>Ice is blocking the infrared sensor.</p>	<p>Empty the ice basket.</p>
	<p>Infrared sensors do not work.</p>	<p>Wipe the infrared sensors clean, or press and hold the ON/OFF button for 5 seconds to force the ice maker to cycle 10 times.</p> <p>If the infrared sensors still do not work, contact customer service.</p>
<p>Not making ice.</p>	<p>If the ice maker has not been cleaned for a long time, a residue may form around the inlet of the water pump.</p>	<p>Run the self-cleaning program using professional ice maker detergent and leave the detergent in the machine for 12 hours to remove scale.</p>
	<p>Ambient or water temperature is too high.</p>	<p>Keep ambient temperature less than 90°F and fill with colder water.</p>
	<p>Water pump is damaged.</p>	<p>Please contact customer service.</p>
	<p>Refrigerating system leaking.</p>	
	<p>Refrigerating system blocked.</p>	
	<p>The fan stopped working.</p>	
	<p>The wires are loose.</p>	
<p>The gears in the motor are broken.</p>		

Problem	Possible Causes	Solution
Ice sticks together.	Making ice takes too long.	Stop making ice. After the ice melts, restart and try again.
	The water temperature is too low.	Fill with water temperatures between 46°F and 77°F.
	Evaporator deformation.	Please contact customer service.
Ice maker creating loud noise.	If the ice maker has not been cleaned for a long time, a residue may form around the inlet of the water pump.	Run the self-cleaning program using professional ice maker detergent and leave the detergent in the machine for 12 hours to remove scale.
		Clean every 1 weeks using mild cleaning agents.
	Lack of water to pump will create noise when pumping water.	Add more water.
	Machine overload.	The water temperature should be 45°F - 90°F.
		Maintain 6" distance between the hot air outlet and the wall.
	Fan or ice maker is damaged.	Please contact customer service.
Water pump is damaged.		

WARRANTY INFORMATION

30-DAY LIMITED WARRANTY

To provide customers with a quality shopping and user experience, the unit can be replaced or returned for a full refund within the 30-day period from the date of purchase.

30-DAY TO 1-YEAR LIMITED WARRANTY

After the 30-day warranty has expired, a 1-year warranty from the date of purchase that covers product replacement is automatically activated. Please note that proof of purchase from an authorized retailer is required for all warranty claims.

30-DAY TO 1-YEAR WARRANTY LIMITATIONS

This warranty does not cover:

- Any condition resulting from incorrect or inadequate maintenance or care.
- Damage resulting from misuse, abuse, negligence, accidents, or shipping damage.
- Dissatisfaction due to buyer's remorse.
- Normal wear and tear.
- Damages incurred after initial transportation.

Questions or Problems?

✉ support@bsqworld.com

860-03994-00 V2

