

**HYUNDAI**  
POWER PRODUCTS

# ELECTRIC CHAINSAW

## HYC1600E & HYC2400E

Instruction Manual



GENUINE PRODUCT OF  
HYUNDAI CORPORATION

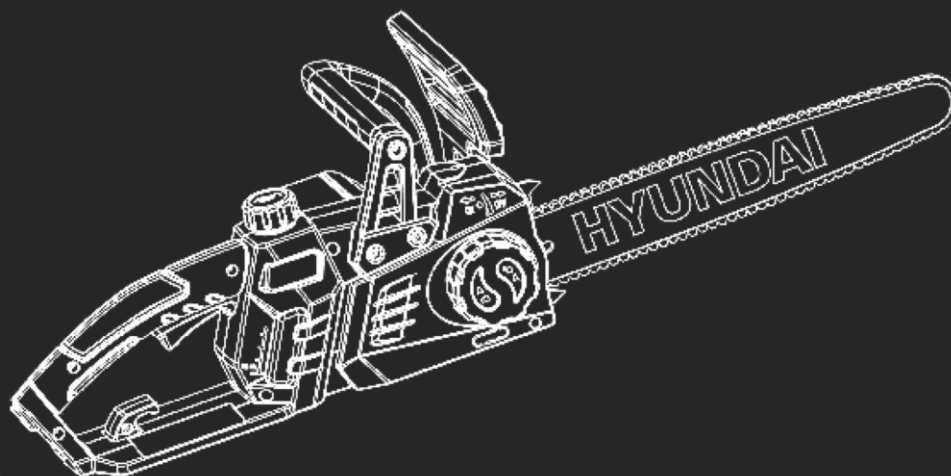

WARNING: Read the instructions carefully before use.

Iss:Jun/25



# HYUNDAI

## POWER PRODUCTS

### Thank You For Purchasing Your HYUNDAI Chainsaw

We work very hard to give all of our customers the best possible service. If you have any problems, before leaving negative feedback, please contact us to give us a chance to resolve the issue.

We would be delighted if you left us positive feedback!  
Thank you for purchasing this product.

Rated **Excellent** on Trustpilot

This manual has been produced by Hyundai Power Products and should be kept with the product. Please read and understand these instructions before you use your product. Failure to do this may result in personal injury or damage to the product.

The safety precautions and warnings are to ensure your safety and protect you from harm or damage to the product.

The information contained in this manual was accurate at the time of production, however HYUNDAI Power Products may make modifications to the product without notification.

GENPOWER LTD  
Isaac Way, London Road,  
Pembroke Dock, UNITED KINGDOM, SA72 4RW  
T: +44 (0) 1646 687 880 F: +44 (0) 1646 686 198  
E: [info@hyundaipowerequipment.co.uk](mailto:info@hyundaipowerequipment.co.uk)  
[www.hyundaipowerproducts.co.uk](http://www.hyundaipowerproducts.co.uk)

# Contents

<b>Symbols On The Machine</b> .....	<b>4</b>	<b>Working</b> .....	<b>29-34</b>
<b>Safety Information</b> .....	<b>5-14</b>	Basic Cutting procedure.....	29-30
Understand Your Machine.....	5	Felling A Tree.....	31
Personal Safety.....	5-6	Notching Undercut.....	32
Inspect Your Machine.....	7	Felling Back Cut.....	32
Work Area.....	7-8	Limbing And pruning.....	33
During Use.....	8	Cutting Spring Poles.....	33
Noise.....	9	Bucking A Log.....	34
Service.....	9	<b>Maintenance And Care</b> .....	<b>35-38</b>
Intended Use.....	9	Maintenance Safety.....	35
Vibrations.....	10	Bar Maintenance.....	35
Personal Protective Equipment.....	11	Other Maintenance.....	36
Electrical Safety.....	12-13	Cleaning.....	36
Electrical Connections.....	13	Storage.....	36
Power Tool Use And Care.....	14	Transporting.....	37
Chainsaw Safety Warnings.....	15-17	Automatic Chain Lubrication.....	37
Kickback.....	18	New Chain Bar And Chain.....	37
<b>Features</b> .....	<b>19</b>	Removing Existing Bar And Chain.....	38
<b>Unboxing</b> .....	<b>20</b>	Fitting A New Bar And Chain.....	38
<b>Assembly</b> .....	<b>21-23</b>	Sharpening The Saw Chain.....	38
Filling With Oil.....	21	<b>Specifications</b> .....	<b>39</b>
Attaching The Chain Bar And Chain.....	22	<b>Spare Parts</b> .....	<b>40</b>
Chain Tension.....	23	<b>Disposal</b> .....	<b>41</b>
Adjusting The Chain Tension.....	23	<b>Our Product Range</b> .....	<b>42</b>
<b>Starting / Stopping</b> .....	<b>24-25</b>	<b>Useful Information</b> .....	<b>43</b>
Before Each Use.....	24	Our YouTube Channel.....	43
Connecting To Power.....	25	Warranty.....	43
Starting.....	25	Manual Updates.....	43
Stopping.....	25	Returning Your Product.....	43
<b>Operating</b> .....	<b>26</b>	Ordering Spare Parts.....	43
The Chain Brake.....	26	<b>Notes</b> .....	<b>44-45</b>
Correct Use Of Chain Brake.....	27	<b>Contact Us</b> .....	<b>46</b>
Testing The Brake.....	27	<b>Declaration Of Conformity</b> .....	<b>47</b>
<b>Using The Chainsaw</b> .....	<b>28</b>		
Holding The Chainsaw Correctly.....	28		

## Contact Us



[www.hyundaipowerproducts.co.uk](http://www.hyundaipowerproducts.co.uk)



01646 687 880



[aftersales@hyundaipowerproducts.co.uk](mailto:aftersales@hyundaipowerproducts.co.uk)

# Symbols On The Machine

## Symbols On The Machine

We have provided safety messages in this manual and on the machine. This information alerts you to potential hazards that could hurt you or others. Please read these messages carefully. However, we may not have listed all of the possible hazards, you must also use your own judgment.



### CAUTION!

Handle carefully.



### INSTRUCTION MANUAL

Read and understand operator's manual before using the machine. Failure to follow instructions could result in death or serious injury.



### HEARING PROTECTION

Suitable safety hearing protection is recommended.



### EYE PROTECTION

Always wear safety glasses/goggles and/or face shields. Everyday eyeglasses have only impact resistant lenses; they are not safety glasses/goggles.



### PROTECT FROM MOISTURE

Do not expose the product to rain or wet conditions.



### DISCONNECT THE PLUG

Disconnect the plug from the mains immediately if the cable has been damaged or cut.



### WEEE SYMBOL

Waste electrical products should not be disposed of with household waste. Please recycle where facilities exist. Check with your local authority or local store for recycling advice.



### PROTECTION CLASS II

Equipped with enhanced or double insulation.



### CE SYMBOL

Double insulation. This product complies with the applicable European directives and an evaluation method of conformity for these directives was done.



### GS MARK

Product has met the quality and safety requirements set forth in the German product Safety Act.

# Safety Information



**⚠ WARNING : READ THE INSTRUCTION BOOKLET THOROUGHLY BEFORE USING THE MACHINE.** Keep for future reference and pass it on if the machine is loaned or sold to another user. In all warnings below, the term “power tool” refers to you electric chainsaw.

## ⚠ Understand Your Machine

- **WARNING!** You must read these instructions carefully before operating the machine. Make sure that you are familiar with the controls and properly operate the machine. You must learn how to stop the machine quickly. If you do not follow the warnings and instructions, it may result in fire and/or serious injury. Make sure to save all warnings and instructions for future reference.
- Read this manual and labels affixed to the machine to understand its limitations and potential hazards.
- Be thoroughly familiar with the controls and their proper operation. Know how to stop the machine and disengage the controls quickly.
- If the unit is to be used by someone other than original purchaser, or is to be loaned, rented, or sold, always provide this manual and any needed safety training before operation. The user can prevent and is responsible for accidents or injuries that may occur to themselves, to other people, or to property.
- Do not force the machine beyond its limits. Use the correct machine for your application.
- Know how to stop the machine quickly in case of emergency. Understand the use of all controls.
- ALL MAINTENANCE other than that listed in this manual, should be carried out by professionally trained and certified personnel.

## ⚠ Personal Safety

- **Stay Alert.** Watch what you are doing and use common sense when operating a power tool. Do not operate tool when you are tired or under the influence of drugs, alcohol or medication. A moment of inattention while operating power tools may result in serious personal injury.
- **Use Safety Equipment.** Always wear eye protection. Safety equipment such as dust mask, non-skid safety shoes, hard hat, or hearing protection used for appropriate conditions will reduce personal injuries.
- **Avoid Accidental Starting.** Ensure the switch is in the off position before plugging in. Carrying power tools with your finger on the switch or plugging in power tools that have the switch on invites accidents.

## Contact Us



[www.hyundaipowerproducts.co.uk](http://www.hyundaipowerproducts.co.uk)



01646 687 880



[aftersales@hyundaipowerproducts.co.uk](mailto:aftersales@hyundaipowerproducts.co.uk)

# Safety Information

## ⚠ Personal Safety (Continued)

- **Remove** adjusting key or wrench before turning the power tool on. A wrench or a key left attached to a rotating part of the power tool may result in personal injury.
- **Do Not Overreach.** Keep proper footing and balance at all times. This enables better control in unexpected situations.
- If dust extraction and collection equipment can be installed, make sure they are connected and used properly. Using a dust extractor can reduce dust hazards.
- **WARNING!** Never allow children or people unfamiliar with these instructions to use the product. Local regulations can restrict the minimum age of the operator.
- Keep children, pets, and other people not using the unit away from the work area. Be alert and shut off the unit if anyone enters work area. Keep children under the watchful care of a responsible adult.
- Appropriate Personal Protective Equipment (PPE), **MUST** be worn at all times when operating or repairing the machine. Always wear anti-slip and resistant work footwear and long trousers while using the machine. Do not use the machine when barefoot, wearing sandals or similar lightweight footwear. Do not wear chains, bracelets or clothing that is loose fitting or hanging ties or cords. Tie long hair back. Always wear protective earplugs. Loose clothes, jewellery, or long hair can be caught in moving parts. Protect eyes, face, and head from objects that may be thrown from the unit. Always wear safety goggles or safety glasses with side shields when operating.
- Always keep hands and feet away from all moving parts during operation. Moving parts can cut or crush body parts. • Always keep hands and feet away from all pinch points.
- Do not touch parts that might be hot from operation. Allow parts to cool before attempting to maintain, adjust, or service.
- Do not overreach. Keep proper footing and balance at all times. This enables better control of the machine in unexpected situations. Extending your body too far can result in a loss of balance and you may fall which will result in injury.
- Never place any part of your body where it would be in danger if movement should occur during assembly, installation, and operation, maintenance, repairing or moving.
- Start the machine carefully according to instructions and with feet away from the moving parts.
- Keep in mind that the operator or user is responsible for accidents, hazards or unexpected events involving the machine that occur to other people or their property. It is the responsibility of the user to assess the potential risk of the area where work is being carried out. The operator or user must take all necessary precautions to ensure their own safety and that of others, especially on slopes or rough, slippery and unstable ground.

For more information, go to

[www.hyundaisupport.co.uk](http://www.hyundaisupport.co.uk)

# Safety Information

## ▲ Inspect Your Machine

- Check your machine before starting it. Keep guards in place and in working order. Make sure all nuts, bolts, etc., are securely tightened.
- You must check the general condition of the machine before use.
- Never operate the machine when it is in need of repair or is in poor mechanical condition. Replace damaged, missing, or failed parts before using it. Keep the machine in safe working condition.
- Do not use the machine if the machine's switch does not turn off when running.
- Avoid accidental starting. Be sure the switch is off before transporting the machine or performing any maintenance or service on the unit. Transporting or performing maintenance or service on a machine with its switch on invites accidents.
- If the machine should start to vibrate abnormally, stop the machine and check immediately for the cause. Vibration is generally a warning sign of trouble.
- Do not tamper with or disable safety systems.
- Only use manufacturer-recommended attachments.
- Before using, always visually inspect to see that the tools are not worn out or damaged. Replace worn out or damaged elements and bolts.
- Keep the machine in good operating condition. Operating a machine in poor or questionable condition could result in serious injury.
- Be sure all safety devices are in working order and warning labels are in place. These items are installed for your safety.

## ▲ Work Area

- Make sure to keep your work area clean and tidy and well lit. Messy and dark areas lead to accidents. You must only work in daylight or with good artificial light in good visibility conditions. Keep people, children and animals away from the working area. Distractions can cause you to lose control.
- Never operate power tools in explosive atmospheres, such as in the presence of flammable liquids, gases or dust. Power tools create sparks which may ignite the dust or fumes.
- Keep children and bystanders away while operating a power tool. Distractions can cause you to lose control.
- Make sure you thoroughly inspect the entire work area and remove all objects and anything that could be a trip hazard. Any liquid spilled on the floor may result in you slipping.

## Contact Us



[www.hyundaipowerproducts.co.uk](http://www.hyundaipowerproducts.co.uk)



01646 687 880



[aftersales@hyundaipowerproducts.co.uk](mailto:aftersales@hyundaipowerproducts.co.uk)

# Safety Information

## ⚠ Work Area (Continued)

- Use the unit in dry conditions only. Protect it from rain and moisture. If there has been heavy rain on the working site, wait until the ground has dried up.
- Never place the machine in a place with unstable ground which could give way.
- You must be careful near ravines, ditches or embankments.
- Exercise extreme caution when operating on or crossing gravel drives, walks, or roads. Stay alert for hidden hazards or traffic.
- Do not work in the rain or when there is a thunderstorm or lightning risk. If there is bad weather conditions, do not use the machine.
- Do not operate power tools in explosive atmospheres, such as in the presence of flammable liquids, gases or dust. Power tools create sparks which may ignite the dust or fumes.

## ⚠ During Use

- Always hold the unit with both hands when operating. Keep a firm grip on the handlebars.
- Walk, never run with the machine.
- Do not operate the machine in confined areas where there may be a risk of crushing the operator between the machine and another object.
- **WARNING!** If something breaks or an accident happens whilst working, you must turn off the machine immediately and move the machine away to prevent further damage. If an accident happens with injuries or third parties are injured, carry out the first aid measures most suitable for the situation immediately and contact the medical authorities for any necessary health care. Carefully remove any debris that might cause damage or harm persons or animals should it not be seen.
- The excessive speed of movement or the absence of maintenance have a significant influence on noise emissions and vibrations. It is necessary to take preventive steps to eliminate possible damage due to high levels of noise and stress from vibration. You must maintain the machine well, wear ear protection and take breaks from working.
- You must turn the machine off (making sure that all moving parts are stationary):
  - Before checking or working on the machine.
  - When lifting or transporting the machine.
  - Whenever you leave the machine unattended.
  - If the unit starts vibrating excessively.
- Do not switch on the unit if there are persons (particularly children) or animals in the immediate vicinity. Ensure that children do not play with the unit. Stop working if you notice that persons (particularly children) or pets are nearby. When stopping work, never leave the unit unattended and keep it in a safe place.

For more information, go to

[www.hyundaisupport.co.uk](http://www.hyundaisupport.co.uk)

# Safety Information

## **⚠ Noise (Where Applicable)**

- The operating noise of the machine can damage your hearing. Wear hearing protection such as earplugs or ear defenders to protect your hearing. Long-term and regular users are advised to have hearing checked regularly. Be especially vigilant and cautious when wearing ear protection because your ability to hear alarm warnings will be reduced.
- Noise emissions for this equipment is unavoidable. Carry out noisy work at approved times and for certain periods. Limit the working time to a minimum. For your personal protection and protection of people working nearby it is also advisable for them to wear hearing protection.

## **⚠ Service**

1. Make sure your power tool serviced by a qualified repair person using only identical replacement parts. This will ensure that the safety of the power tool is maintained.
2. Do not remove or modify any safety components as this may result in damage to your machine or serious personal injury.

## **⚠ Intended Use**

The HYC1600E / HYC2400E is an electric chainsaw from HYUNDAI.

The product is only intended for sawing wood for domestic purposes. The saw is not designed for cutting any other material.

The chainsaw is manufactured according to the latest safety requirements. Every precaution is only effective when it is followed exactly.

## Contact Us

# Safety Information

## ⚠ Vibrations (Where Applicable)

- Prolonged use of hand held (operated) machines will cause the user to feel the effects of/from vibrations. These vibrations can lead to white finger (Raynaud's phenomenon) or carpal tunnel syndrome. This condition reduces the ability of the hand to feel and regulate temperature, causing numbness and heat sensations and may cause nerve damage and circulatory tissue death.
- Not all factors that lead to white finger disease are known, but cold weather, smoking and other diseases that affect blood vessels and blood circulation as well as large and long-lasting impact of shocks are considered factors in the formation of white finger. Note the following to reduce the risk of white finger and carpal tunnel syndrome;
- Wear gloves and keep your hands warm.
- Take regular breaks.
- All of the above precautions may help reduce the risk of white finger disease but not rule out the carpal tunnel syndrome. Long-term and regular users are therefore recommended to observe the condition of your hands and fingers. Seek medical attention immediately if any of the above symptoms should occur.

## ⚠ Effects Of Vibration

Vibration white finger (VWF) is an injury triggered by continuous use of vibrating hand-held machinery. If you continue to use high-vibration tools these symptoms will probably get worse, for example:

- The numbness in your hands could become permanent and you won't be able to feel things at all;
- You will have difficulty picking up small objects such as screws or nails;
- Vibration White Finger (VWF) could happen more frequently and affect more of your fingers.

## ⚠ Protecting Your Body From Vibration

Please observe the following matter, in order to protect the health of your body.

- Always use the right tool for each job (to do the job more quickly and expose you to less hand-arm vibration).
- Check tools before using them to make sure they have been properly maintained and repaired to avoid increased vibration caused by faults or general wear.
- Make sure cutting tools are kept sharp so that they remain efficient.
- Reduce the amount of time you use a tool in one go, by doing other jobs in between.
- Avoid gripping or forcing a tool or workpiece more than you have to.
- Store tools so that they do not have very cold handles when next used.

For more information, go to

[www.hyundaisupport.co.uk](http://www.hyundaisupport.co.uk)

# Safety Information

## ⚠ Clothing And Personal Protective Equipment (PPE)

Appropriate Personal Protective Equipment (PPE), **MUST** be worn at all times when operating or repairing the machine. No protective equipment can ensure 100% protection.

When selecting PPE, make sure it's CE marked and it suits the user in terms of size, fit etc. If more than one item of PPE is worn at the same time, make sure they can be used together, e.g. wearing safety glasses may disturb the seal of a respirator, causing air leaks.



### HELMET

Safety helmet with mesh visor.



### HEARING PROTECTION

Suitable safety hearing protection is recommended.



### GLOVES

Protective electrically non-conductive gloves are highly recommended when working. Specialist chainsaw gloves with approved saw protection.



### BOOTS

Non-skid heavy duty footwear are highly recommended when working. Safety boots with toe and shin protection.



### CLOTHING

Do not wear loose clothing, gloves, scarfs, neckties or jewellery (rings, wrist watches), which can be caught in moving parts. Trousers or chaps suitable for chainsaw use (they contain a clogging material which stops the chain if cut). Close fitting hi-visibility jacket. Do secure long hair so that it is above shoulder level.



### EYE PROTECTION

Always wear safety glasses/goggles and/or face shields. Everyday eyeglasses have only impact resistant lenses; they are not safety glasses/goggles.

## Contact Us

# Safety Information

## ⚠ Electrical Safety



**DANGER!**

**ELECTRICITY CAN KILL - NEVER WORK ON LIVE/ENERGISED EQUIPMENT.**

- Prior to carrying out any maintenance work you **MUST** identify electrical isolation methods and isolate all electrical supplies.
- Prior to use and with all electrical supplies isolated, you **MUST** check all electrical cables, plugs and connectors for the following;
  - Are intact and have no signs of damage, to include but not limited to bare wires, chaffing, cuts and loose wiring.
  - If there are any signs of damage, the damaged item **MUST** be taken out of service until the damage has been repaired by an electrically competent person.
- All trailing cables should be routed so as not to cause any kind of trip hazard.
- **NEVER** work on or near electricity with wet hands, wet clothing and wet gloves.
- Power tool plugs must match the outlet. Never modify the plug in any way. Do not use any adapter plugs with earthed (grounded) power tools. Unmodified plugs and matching outlets will reduce risk of electric shock.
- Avoid body contact with earthed or grounded surfaces, such as pipes, radiators, ranges and refrigerators. There is an increased risk of electric shock if your body is earthed or grounded.
- Do not expose power tools to rain or wet conditions. Water entering a power tool will increase the risk of electric shock.
- Do not abuse the cord. Never use the cord for carrying, pulling or unplugging the power tool. Keep cord away from heat, oil, sharp edges and moving parts. Damaged or entangled cords increase the risk of electric shock.
- When operating a power tool outdoors, use an extension cord suitable for outdoor use. Use of a cord suitable for outdoor use reduces the risk of electric shock.
- If operating a power tool in a damp location is unavoidable, use a residual current device (RCD) protected supply. Use of an RCD reduces the risk of electric shock.
- You must avoid body contact with earthed or grounded surfaces such as pipes, radiators, ranges or refrigerators. There is an increased risk of electric shock if your body is earthed or grounded.
- Never expose power tools to rain or wet conditions. Water entering a power tool will increase the risk of electric shock.

For more information, go to

[www.hyundaisupport.co.uk](http://www.hyundaisupport.co.uk)

# Safety Information

## ⚠ Electrical Safety (Continued)

- When operating a power tool outdoors, use an extension cord suitable for outdoor use. Use of a cord suitable for outdoor use reduces the risk of electric shock.
- Use outdoor extension leads. If working outdoors, always use an approved cable extension suitable for the power rating of this tool, the conductor size should also be at least the same size as that on the machine, or larger. When using a cable reel, always unwind the cable completely. We strongly recommend that this machine is connected to the mains supply via a Residual Current Device (RCD).
- Do not use the cord to carry the power tool, hang it up or pull it out of the socket. Keep the cable away from heat, oil, sharp edges or moving parts of the equipment. Damaged or entangled cables increase the risk of electric shock.
- The plug of the power tool must fit into the socket. The plug must not be changed in any way. Do not use adapter plugs together with electrically grounded power tools. Unmodified plugs and matching sockets reduce the risk of electric shock.

## ⚠ Electrical Connections

**⚠ WARNING! You must read these electrical safety instructions thoroughly before connecting the product to the mains supply.**

The fuse in the plug must be rated at 13 amps and approved to BS1362. We recommend that this machine is connected to the mains supply via a Residual Current Device (RCD). If in any doubt, DO NOT attempt any connections or repairs yourself. Consult a qualified electrician, or contact Genpower Ltd.

**We strongly recommend that this machine is connected to the mains supply via a Residual Current Device (RCD).**

If in any doubt, consult a qualified electrician. DO NOT attempt any repairs yourself.



**This symbol indicates that this is a Class II product, and does not require an earth connection.**

## Contact Us



[www.hyundaipowerproducts.co.uk](http://www.hyundaipowerproducts.co.uk)



01646 687 880



[aftersales@hyundaipowerproducts.co.uk](mailto:aftersales@hyundaipowerproducts.co.uk)

# Safety Information

## ⚠ Power Tool Use And Care

- **Do Not Force The Tool.** Use the correct power tool for your application. The correct power tools will do the job better and safer at the rate for which it was designed.
- **Do Not** use the power tool if the switch does not turn it on and off. Any power tool that cannot be controlled with the switch is dangerous and must be repaired.
- Disconnect the plug from the power source before making any adjustments, changing accessories, or storing power tools. Such preventive safety measures reduce the risk of starting the power tool accidentally.
- Store idle power tools out of the reach of children and do not allow persons unfamiliar with the power tool or these instructions to operate the power tool. Power tools are dangerous in the hands of untrained users.
- Maintain power tools, check for misalignment or binding of moving parts, breakage of parts and any other condition that may affect the power tools operation. If damaged, have the power tool repaired before use. Many accidents are caused by poorly maintained power tools.
- Use the power tool, accessories and tool bits etc., in accordance with these instructions and in the manner intended for particular type of power tool, taking into account the working conditions and the work to be performed. Use of the power tool for operations different from intended could result in a hazardous situation.
- Before use check the supply and extension cord for signs for signs of damage or aging.
- If the cord becomes damaged during use, disconnect the cord from the supply immediately.
- **WARNING:** Cutting elements continue to rotate after the motor is switched off.
- Check plug and cable for damage before inserting the plug into the socket. If damaged, have it replaced by a specialist immediately. Damaged cables and plugs or connection cables that do not comply with the regulations must not be used.
- Only insert the plug into the socket when the machine is switched off.

# Safety Information

## ⚠ Chainsaw Safety Warnings

- You must keep all parts of the body away from the chain when the chainsaw is operating. Before you start the chainsaw, make sure the chain is not contacting anything. A moment of inattention while operating chainsaws may cause entanglement of your clothing or body with the saw chain.
- Always hold the chainsaw with your right hand on the rear handle and your left hand on the front handle. Holding the chainsaw with a reversed hand configuration increases the risk of personal injury and should never be done.
- Hold the power tool by insulated gripping surfaces only, because the saw chain may contact hidden wiring or its own cord. Saw chains contacting a “live” wire may make exposed metal parts of the power tool “live” and could give the operator an electric shock.
- Wear safety glasses and hearing protection. Further protective equipment for head, hands, legs and feet is recommended. Adequate protective clothing will reduce personal injury by flying debris or accidental contact with the saw chain.
- Do not operate a chainsaw in a tree. Operation of a chainsaw while up in a tree may result in personal injury.
- Always keep proper footing and operate the chainsaw only when standing on a fixed, secure and level surface. Slippery or unstable surfaces such as ladders may cause a loss of balance or control of the chainsaw.
- When cutting a branch that is under tension be alert for spring back. When the tension in the wood fibres is released the spring loaded limb may strike the operator and/or throw the chainsaw out of control.
- Use extreme caution when cutting bush and saplings. The slender material may catch the saw chain and be whipped toward you or pull you off balance.
- Carry the chainsaw by the front handle with the chainsaw switched off and away from your body. When transporting or storing the chainsaw always fit the guide bar cover. Proper handling of the chainsaw will reduce the likelihood of accidental contact with the moving saw chain.
- Follow instructions for lubricating, chain tensioning and changing accessories. Improperly tensioned or lubricated chain may either break or increase the chance for kick-back.
- Keep handles dry, clean and free from oil and grease. Greasy, oily handles are slippery causing loss of control.
- Cut wood only. Do not use chainsaw for purposes not intended. For example: do not use chainsaw for cutting plastic, masonry or non-wood building materials. Use of the chainsaw for operations different than intended could result in a hazardous situation.

## Contact Us



[www.hyundaipowerproducts.co.uk](http://www.hyundaipowerproducts.co.uk)



01646 687 880



[aftersales@hyundaipowerproducts.co.uk](mailto:aftersales@hyundaipowerproducts.co.uk)

# Safety Information

## ▲ Chainsaw Safety Warnings (Continued)

- Never operate a chain saw when you are fatigued, ill, or upset, or under the influence of medication that may make you drowsy, or if you are under the influence of alcohol or drugs - risk of accident!
- Cut wood only. Do not use chainsaw for purposes not intended. For example: do not use chainsaw for cutting plastic, masonry or non-wood building materials. Use of the chainsaw for operations different than intended could result in a hazardous situation.
- Do not allow other persons to be near the chain saw when starting or cutting. Keep bystanders and animals out of the work area. Children, pets and bystanders should be a minimum of 10m away when you start or operate the chainsaw - risk of accident!
- Never start cutting until you have a clear work area, secure footing, and a planned retreat path from the falling tree - risk of accident!
- Never allow children to use the machine.
- The chainsaw has been specially designed for tree maintenance and should only be used by trained operators.
- Always inspect the chainsaw before use for worn, loose or damaged parts.
- Do not let anyone near the chainsaw when starting or cutting. Keep everyone, especially children, away from the work area.
- Do not start cutting until you have a clear cutting area and a secure footing.
- Never cut trees or foliage in high wind, bad weather or when there is poor visibility.
- Do not operate the chainsaw with one hand. Always hold the chainsaw firmly with both hands.
- Be alert for the phenomena of “skating” and “bouncing”.
- Be cautious not to lose balance of your body due to “drop” at the end of a cut.
- Always turn the chainsaw off before putting it down.
- Switch off the chainsaw before releasing the chain brake.
- The saw must be free when starting up.

For more information, go to

[www.hyundaisupport.co.uk](http://www.hyundaisupport.co.uk)

# Safety Information

- The chainsaw must only be operated by one person. Other persons are forbidden to stay in the swivelling range of the chainsaw. Pay special attention to children and pets.
- Children and adolescents are not allowed to operate the chainsaw. If you pass this chainsaw on to anybody else, you must give them the instruction manual.
- First time users should practise cutting logs on a saw horse or stand.
- Working with the chainsaw is only allowed if you are well-rested and healthy, e.g. in good physically condition. Take regular breaks. You must not operate the chainsaw after drinking alcohol.
- Pull the chainsaw out of the wood with only a running saw chain.
- Do not work whilst on a ladder, in a tree or similar unstable locations.
- Mains cable should always be routed from behind the operator and away from the machine.
- If replacement of the cable is required, this must be done by the manufacturer to avoid any safety hazards.
- When sawing thin wood, use a safe support (saw horse). The wood should not be stacked and should not be held by anyone else or by your foot.
- Round logs are to be secured.
- The chain saw can be pushed toward the operator when cutting with the top of the rail when the saw chain gets stuck. Therefore, if possible, sawing should be done with the underside of the rail, as the saw is pulled away from the body towards the wood.
- Be careful when cutting splintered wood. Saw cut pieces of wood can be carried along.
- Do not use the chainsaw for lifting and scooping when removing pieces of wood or other.
- This chainsaw is not suitable for forestry work i.e. felling and de-forestry. The necessary mobility and safety of the saw guide is not guaranteed here by the cable connection.
- Even if you operate the power tool correctly, residual risks always remain. The following hazards may occur in connection with the design and construction of this power tool:
  - Injuries and property damage caused by flying parts.
  - Ear damage if you do not wear suitable hearing protection or use the power tool for a long period of time.
  - Health damage resulting from hand-arm vibrations if the power tool is used for an extended period of time or is not properly managed and maintained.

## Contact Us



[www.hyundaipowerproducts.co.uk](http://www.hyundaipowerproducts.co.uk)



01646 687 880



[aftersales@hyundaipowerproducts.co.uk](mailto:aftersales@hyundaipowerproducts.co.uk)

# Safety Information

## ▲ Causes And Prevention Of Kickback

Kick-back may occur when the nose or tip of the guide bar touches an object, or when the wood closes in and pinches the saw chain in the cut.

Tip contact in some cases may cause a sudden reverse reaction, kicking the guide bar up and back towards the operator. Pinching the saw chain along the top of the guide bar may push the guide bar rapidly back towards the operator. Either of these reactions may cause you to lose control of the saw which could result in serious personal injury. Do not rely exclusively upon the safety devices built into your saw. As a chainsaw user, you should take several steps to keep your cutting jobs free from accident or injury.

Kick-back is the result of tool misuse and/or incorrect operating procedures or conditions and can be avoided by taking proper precautions as given below:

- 1 Maintain a firm grip, with thumbs and fingers encircling the chainsaw handles with both hands on the saw and position your body and arm to allow you to resist kick-back forces. Kick-back forces can be controlled by the operator, if proper precautions are taken. Do not let go of the chainsaw.
- 2 Do not overreach and do not cut above shoulder height. This helps prevent unintended tip contact and enables better control of the chainsaw in unexpected situations.
- 3 Only use replacement bars and chains specified by the manufacturer. Incorrect replacement bars and chains may cause chain breakage and/or kick-back.
- 4 Follow the manufacturer's sharpening and maintenance instructions for the saw chain. Decreasing the depth gauge height can lead to increased kick-back.
- 5 Do not rely exclusively on the safety devices built into your saw.
- 6 When the chainsaw fails to dig in during a cut, the guide bar can begin hopping or dangerously skidding along the surface of the log or branch, possibly resulting in the loss of control of the chainsaw. To prevent or reduce skating or bouncing, hold the chainsaw with two hands and make sure the saw chain establishes a groove for cutting.
- 7 You cannot control reactive forces and you may lose control of the saw, which can result in skating and bouncing of the bar along the limb or log.
- 8 Work cautiously and methodically.
- 9 Do not cut above shoulder height and do not lean too far forward.
- 10 Always cut with a correctly sharpened, properly tensioned saw chain – the depth gauge setting must not be too large.
- 11 Be alert for shifting of the log or other forces that may cause the cut to close and pinch the chain.
- 12 Use extreme caution when re-entering a previous cut.

For more information, go to

[www.hyundaisupport.co.uk](http://www.hyundaisupport.co.uk)

# Features

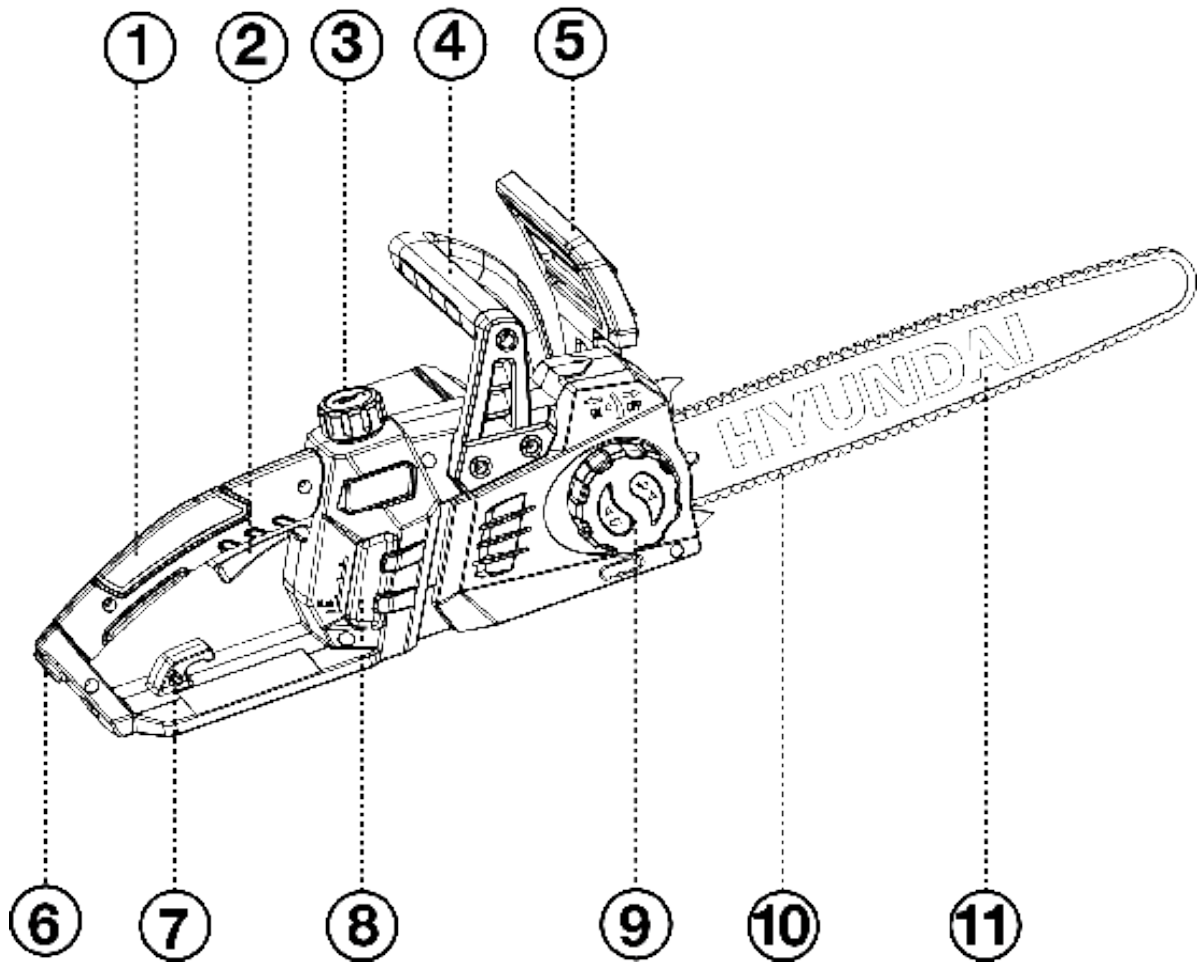

- 1 - Rear Handle
- 2 - On/Off Switch
- 3 - Oil Filler Cap
- 4 - Front Handle
- 5 - Chain Brake
- 6 - Cable Sheath
- 7 - Cable Hook
- 8 - Oil Level Indicator
- 9 - Chain Adjuster
- 10 - Chain
- 11 - Chain Guide Bar

## Contact Us

# Unboxing

## Unboxing Safety

 **WARNING!** Unboxing and assembling the machine should be done on a flat, stable surface with enough room. Disposal of the packaging should be done in accordance with the local regulations in force.

Carefully remove the product from the packaging and examine it for any sign of damage caused during shipping. Lay the contents out and check them. If any part is damaged or missing, you must not use the machine. Contact HYUNDAI Power Products immediately. You must keep the packaging material in case the machine needs to be returned or repaired.

 **WARNING!** Some of the packaging material may be harmful to children. Keep out of reach of children.

 **NOTE!** The batteries are not fully charged on delivery. Prior to initial operation, charge the batteries fully. See user manual of the battery charger.

## Box Contents

- HYC1600E / HYC2400E Chainsaw
- Guide Bar
- Saw Chain
- Bar Cover
- User Manual

For more information, go to

[www.hyundaisupport.co.uk](http://www.hyundaisupport.co.uk)

# Assembly

## Assembly Safety

**⚠ WARNING - Make sure that you have read and understood all the safety warnings before continuing with the assembly.**

**⚠ WARNING - Make sure that the chainsaw is disconnected from the mains supply during all checks and adjustments.**

**⚠ CAUTION - This guide is meant to serve as a quick reference for operating your HYUNDAI machine. We always advise reading the manual in full before operation.**

**⚠ NOTE - Images may vary depending on model.**

**⚠ NOTE - The machine can be supplied with some parts already assembled. Prior to assembly, check all items have been received.**

## Filing With Oil

1. Place the chainsaw on a stable and flat surface.
2. Unscrew and remove the oil filler cap.
3. Fill the oil tank with chainsaw oil using a funnel.
4. Refit the oil filler cap. Wipe up any spillage before continuing. The oil level should be checked frequently during use and topped up as necessary. Using the saw without chainsaw oil will damage the chain, sprocket and bar.

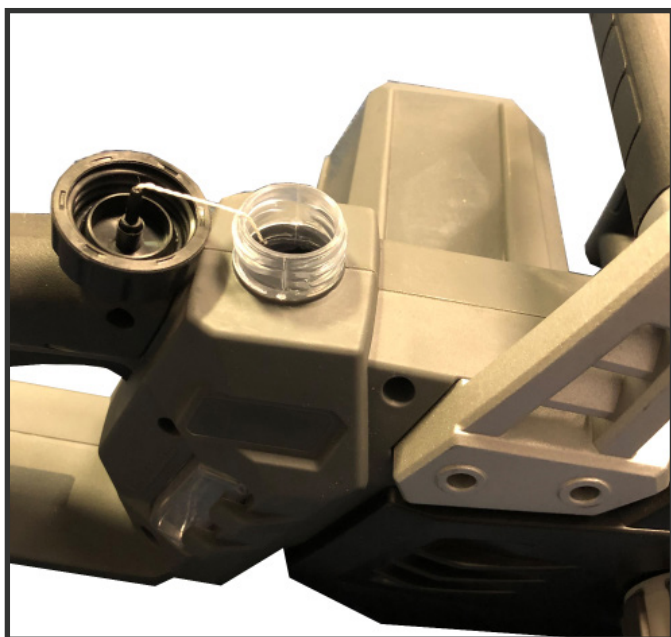

**NOTE - The machine is delivered without oil in the machine. All machines are tested and inspected so there may be some residual oil left in the machine so please fill with caution.**

## Contact Us

# Assembly

## Attaching The Chain Bar And Chain

1. Place the chainsaw on a stable and flat surface. Unplug the chainsaw from electric supply.
2. Loosen the large adjusting knob by turning anticlockwise and remove the cover.



3. Place the chain onto the bar. The chain bar is marked with an arrow that shows you the direction in which the chain will travel. Make sure all the chain links are seated correctly into the groove in the chain bar. The cutting teeth on the upper side of the bar must point forward, as marked on the bar.
4. Put the free end of the chain over the drive sprocket. To secure the bar, replace the cover and tighten the large adjusting knob finger tight. Adjust the blade tension as follows.



For more information, go to

[www.hyundaisupport.co.uk](http://www.hyundaisupport.co.uk)

# Assembly

## Chain Tension

Correct chain tension is extremely important and must always be checked before starting work. When using the chainsaw for the first time (or after replacing the chain) the tension should be checked regularly, as a new chain will stretch after several cuts.

If the chain is too loose or too tight, the sprocket, bar and chain will wear more rapidly. The tension should be sufficient to keep the chain snug on the bar, but loose enough to allow the chain to be pulled around by a gloved hand. Taking time to adjust the chain tension correctly will result in improved cutting performance and prolonged chain life.

## To Adjust The Chain Tension

**WARNING! Always wear protective gloves, when adjusting the chain tension and never check the chain tension when the chainsaw is connected to the mains supply.**

1. **Unplug from mains electric supply.** Tighten the large adjuster knob clockwise one and a half turns.

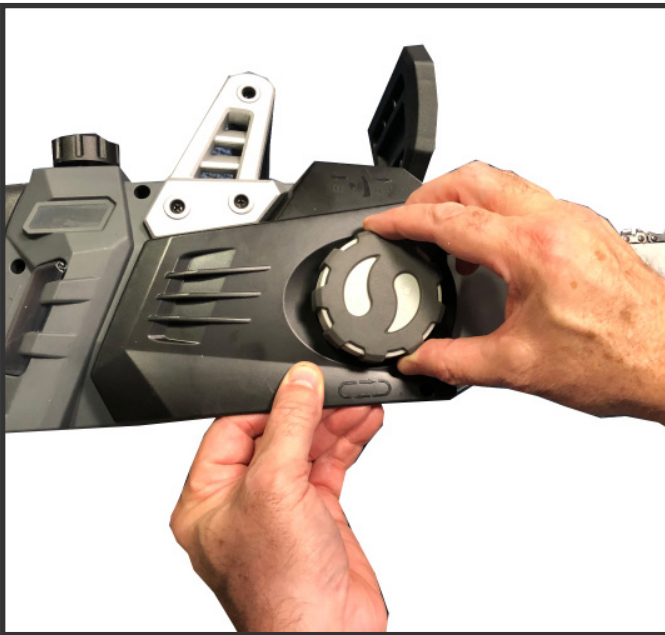

2. When the chain needs re-tensioning, loosen the large adjuster knob two to three turns until the tension on the bar is released, then tighten clockwise until tension is applied to the bar, then a further one and a half turns.

3. Pull the chain gently downwards at the centre of the bar. The chain is correctly adjusted when gentle pulling only results in it moving 2-3 mm away from the chain bar.

4. Finally, with chain brake pulled back, push in the trigger lock and squeeze the trigger, whilst holding the trigger, pull the chain around the bar with a gloved hand - it should fit snugly around the bar and move freely and smoothly.

**NOTE: If the chain binds or is difficult to rotate by hand, too much tension has been applied. Repeat steps 2 to 6, turning the blade tensioning wheel anticlockwise slightly to reduce the tension.**

## Contact Us

# Starting / Stopping

## Before Each Use

**WARNING! Do not start the chainsaw until it is fully assembled and adjusted and you have read all warnings and safety instructions.**

For 'first time' users of this type of product, we recommend that introductory training is undertaken from an experienced person before use.

Check the following points before each use to work safely:

## Condition Of The Chainsaw

Examine the chainsaw for damage to the chassis, power cord, saw chain, and blade before beginning work. Never put an obviously damaged device into operation.

## Oil Container

Check the level of the oil tank. Also check during work that there is always enough oil. Never operate the saw when there is no oil or the oil level has dropped below the minimum mark.

## Saw Chain

Check the tension of the saw chain and the state of the saw chain. The sharper the chain, the easier and more controllable the chainsaw can handle. A dull chain will increase cutting time, and pressing a dull chain through wood will increase the vibrations transmitted to your hands. A saw with loose components or with damaged or worn AV bushes will also tend to have higher vibration levels. You must check the chain tension every 15 minutes during work to increase your safety. Especially new chains, which are prone to increased expansion.

## Chain Brake

Check the chain brake function as described on page 26-27.

# Starting / Stopping

## Connecting To Power

1. To prevent strain on the cable during use, make a small loop in the power cable.
2. Put the loop through the hole in the handle and on the hook.
3. Slowly pull the loop back to remove the slack.
4. Connect the plug to a power socket.

**NOTE:** We strongly recommend that this machine is connected to the mains supply via a Residual Current Device (RCD).

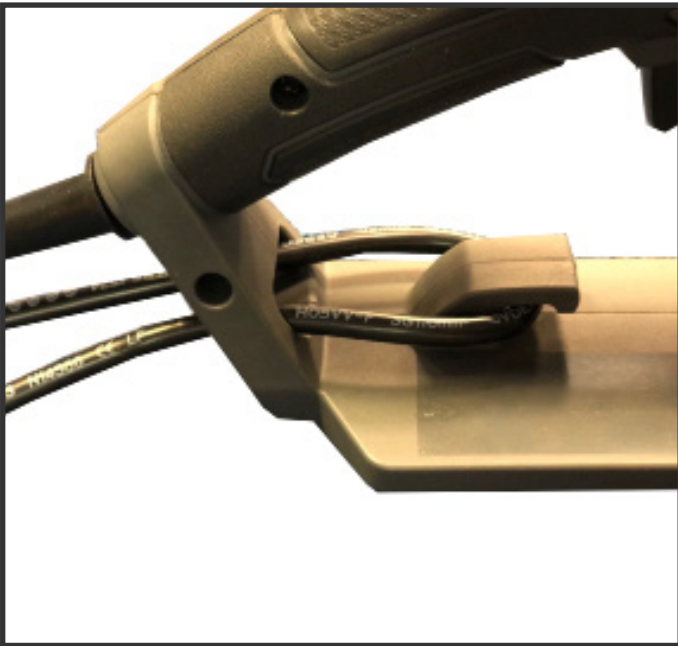

## Starting

1. Make sure that the chain brake is in the disengaged position (pulled back towards the handle).
2. Start the chainsaw by pushing the trigger lock button with your thumb and squeezing the trigger switch.

**NOTE:** Check the blade tension after every 15 minutes of use.

## Stopping

1. Release the trigger to stop the chainsaw.

## Contact Us

# Operating

## The Chain Brake

 Always check that chain brake works properly before use.

**CAUTION!** The chain brake has been designed to reduce the possibility of injury if kickback occurs. However, it cannot be relied upon to protect you against injury if the chainsaw is used carelessly. Take great care when cutting, and always test the brake before using the saw.

During kickback, the chain brake will strike your left forearm, engaging the chain brake. When the brake is activated the chain will stop.

The chain brake is a device which stops the chain should the chainsaw recoil due to kickback. Normally, the brake is activated automatically by inertial force, however it can also be activated manually by pressing the brake lever forward / away from you.

- The chain brake is released (the chain can move) when the chain brake lever is pulled back towards the handle.
- The brake is engaged (chain is stopped) when the chain brake lever pushed forward away from the handle.

Release the chain brake by pulling the chain brake lever back towards the handle.

**WARNING!** If the chain fails to stop when the chain brake is engaged, do not use the chainsaw. You should return your chainsaw to your dealer for advice.

## To Release The Brake

Release the chain brake by pulling the handle towards you when holding the saw. Some force maybe required to disengage the brake. This is to prevent the accidental releasing of the brake while in use.

## To Engage The Brake

Engage the brake by pushing the brake handle away from you when holding the saw. The brake is spring loaded so after some initial force the brake will move forward on its on momentum. If the brake operates during use immediately release the throttle and reset the chain brake when it is safe to resume use.

# Operating

## Correct Use Of Chain Brake

- If the chain brake is clogged with wood chips the effectiveness of the brake is diminished.
- You must always keep the device clean.
- Do not try to increase motor revolutions while the chain brake is engaged. The motor will not provide power whilst the chain brake is engaged.
- Do not use it unless absolutely necessary.
- Never test the brake in an area where petrol fumes are present.

The following may interfere with the brake's ability to protect the operator:

- Saw wrongly held too close to operator's body.
- Kickback time may be too fast even for a perfectly maintained brake to work in time.
- The operator's hand may not be in position to contact the hand guard. Brake will not be tripped.
- Lack of proper maintenance lengthens the brake's stopping time, making it less effective.
- Dirt, grease, oil, pitch, etc. getting into the working parts of the mechanism may lengthen the stopping time.
- Wear and fatigue of the activating brake spring, and wear of the brake / clutch drum and pivot points may lengthen the brake's stopping time.
- A damaged hand guard and lever may render the brake inoperative.

## Testing The Brake

1. Start the chainsaw
2. Place the chain saw on the ground.
3. Hold the rear handle with your right hand and the front handle with your left hand.
4. Accelerate the chainsaw to high speed by using the throttle trigger.
5. Operate the chain brake by turning your left wrist against the front hand guard whilst gripping the front handle.
6. The chain should stop immediately.
7. Release the power trigger.

If the chain does not stop immediately contact Hyundai Power Products.

## Contact Us



# Using The Chainsaw

**NOTE:** We strongly recommend that this machine is connected to the mains supply via a Residual Current Device (RCD).

## Holding The Chainsaw Correctly

Hold the chainsaw firmly with both hands. Always keep your left hand on the front handle and your right hand on the rear handle. Holding the chainsaw with a reversed hand configuration increases the risk of personal injury and should never be done.

Use a firm and proper grip when holding the handles to maintain control, your finger and thumbs should encircle the handles.

Keep your body to the left of the blade at all times.

**WARNING!** Do not use the front guard as a handle. Never use a left handed (cross-handed) grip or any grip that places your body or arm across the cutting line.

## Basic Cutting Procedure

**WARNING! Chainsaws by their very nature are extremely dangerous machines and should be handled with respect!**

We strongly recommend that before use of this product, you attend a chainsaw training course to familiarise yourself with the maintenance and usage of these products! Thoroughly read this manual and adhere to all safety instructions at all times. The manufacturer will not be held liable for any accidents/injuries caused due to misuse or incorrect maintenance of this product!

1. To become proficient, attend a recognised chainsaw training course to learn how to operate chainsaws safely and effectively. Familiarise yourself with all the controls and switches. Practice all movements with the product switched off.
2. Always hold the product firmly with both hands; front handle with the left hand and rear handle with the right hand. Fully grip both handles at all times during operation. Never operate the product using only one hand.
3. Only use the product with a secure stance. Hold the product at the right-hand side of your body (See below image 1).
4. Check the lubrication. Start the machine and check whether the chain can give off a spray of oil within a few seconds. If an oil trace can be seen, the chainsaw is lubricating. (Image 2).



Continued 

## Basic Cutting Procedure (Continued)

5. Ensure the saw chain is running at full speed before it makes contact with the wood. Use spiked bumper to secure the product onto the wood before starting to cut and use it as a leverage point while cutting (See below).

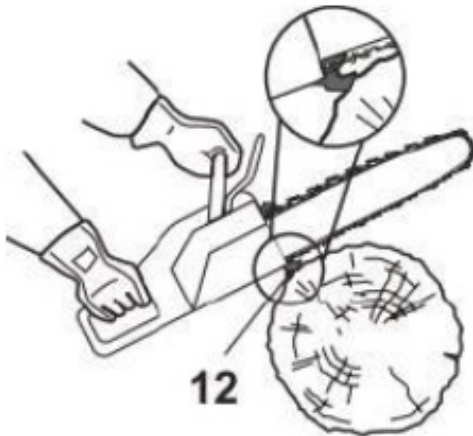

6. Reset the spiked bumper at a low point when cutting thicker logs by pulling the product slightly backwards, until the gripping teeth release and re-position at lower level to continue sawing. Do not remove the product completely from the wood.

7. Do not force the saw chain while cutting, let the chain do the work using the gripping teeth to apply minimal leverage pressure.

8. Do not operate the product with arms fully extended or attempt to saw areas which are difficult to reach, or on a ladder. Never use the product above shoulder height (See below).

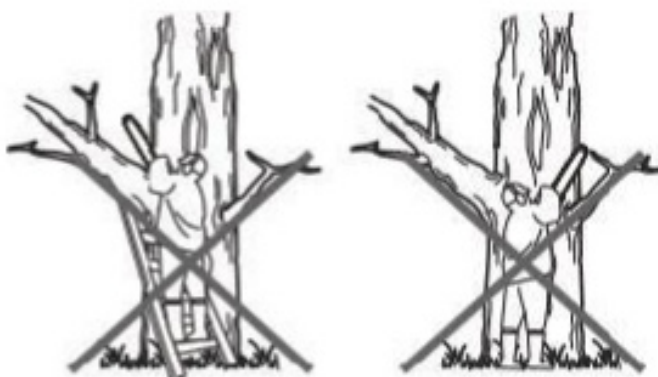

9. Optimum sawing is achieved if the chain speed remains constant during cutting.

10. Be careful when reaching the end of the cut. The weight of the product may change unexpectedly as it cuts free from the wood. This can cause accidents to the legs and feet. Always remove the product from a wood cut while the product is running.

11. Check that the oil feed to the chain is operating correctly; run the chain saw at medium speed and ensure that the chain has received a consistent coating of oil.

# Working

## Felling A Tree

**WARNING! Before commencing work or attempting to fell any tree, check with your local council to ensure you have permission!**

Even in your own garden you may be in a conservation area, the tree you wish to fell may have a conservation order against it or the tree may be visible on the plans of your house – In all these instances and more, you may be required to obtain permission before work can begin.

1. When bucking and felling operations are being performed by two or more persons at the same time, the felling operations should be separated from the bucking operation by a distance of at least twice the height of the tree being felled. Trees should not be felled in a manner that would endanger any person, strike any utility line or cause any property damage. If the tree does make contact with any utility line, the company should be notified immediately.
2. The product operator should keep on the uphill side of the terrain as the tree is likely to roll or slide downhill after it is felled.
3. An escape path should be planned and cleared as necessary before cuts are started. The escape path should extend back and diagonally to the rear of the expected line of fall (See below).

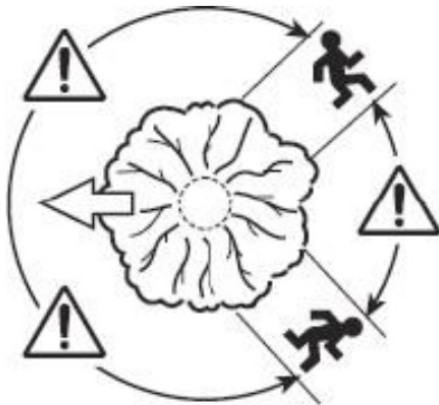

4. Before felling is started, consider the natural lean of the tree, the location of larger branches and the wind direction to judge which way the tree will fall.
5. Remove dirt, stones, loose bark, nails, staples and wire from the tree.

## Contact Us

# Working

## Notching Undercut

Make the notch (see figure below - B) 1/3 the diameter of the tree, perpendicular to the direction of falls. Make the lower horizontal notching cut first. This will help to avoid pinching either the saw chain or the guide bar when the second notch is being made.

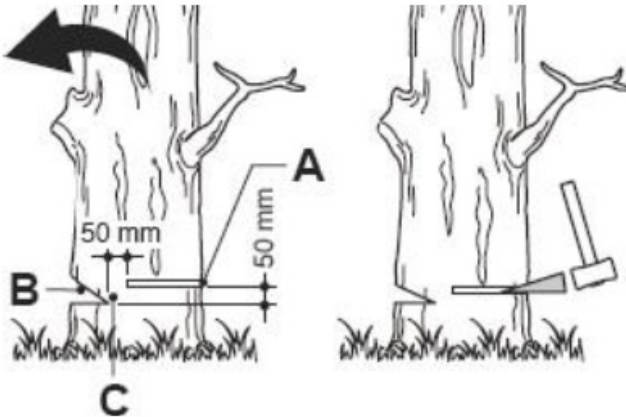

## Felling Back Cut

1. Make the felling back cut (see below - A) at least 50mm higher than the horizontal notching cut. Keep the felling back cut parallel to the horizontal notching cut. Make the felling back cut so enough wood is left to act as a hinge. The hinge wood (see below - C) keeps the tree from twisting and falling in the wrong direction. Do not cut through the hinge.

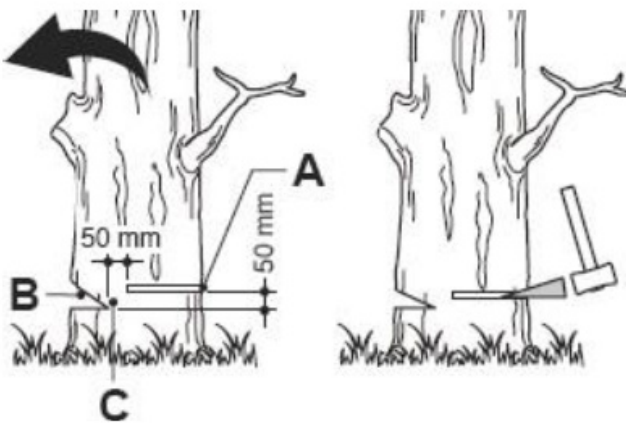

2. As the felling gets close to the hinge, the tree should begin to fall. If there is any chance that the tree may not fall in the desired direction or it may rock back and bind the saw chain, stop cutting before the felling back cut is complete and use wedges of wood, plastic or aluminium to open the cut and drop the tree along the desired line of fall.

3. When the tree begins to fall, remove the product from the cut, stop the motor, put the product down, and then use the retreat path planned. Be alert for overhead limbs falling and watch your footing.

For more information, go to

[www.hyundaisupport.co.uk](http://www.hyundaisupport.co.uk)

# Working

## Limbing And Pruning

Limbing is removing the branches from a fallen tree. When limbing leave larger lower limbs to support the log off the ground. Remove the small limbs in one cut (see below). Branches under tension should be cut from the bottom up to avoid binding the product.

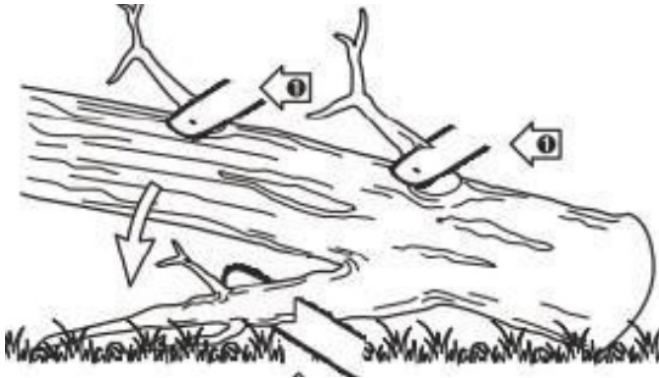

**WARNING! Never climb into a tree to limb or prune! Do not stand on ladders, platforms, logs, or in any position which may cause you to lose the balance or control of the saw! When pruning trees, it is important not to make the flush cut next to main limb or trunk until you have cut off the limb further out to reduce the weight! This prevents stripping the bark from the main member!**

**WARNING! If the branches to be pruned are above chest height, hire a professional to perform the pruning!**

## Cutting Spring Poles

1. A spring pole is any log, branch, rooted stump, or sapling which is bent under tension by other wood, so that it springs back if the wood holding it is cut or removed (see figure below).



2. On a fallen tree, a rooted stump has a high potential of springing back to the upright position during the bucking cut to separate the log from the stump.

3. Watch out for spring poles, they are dangerous.

## Contact Us

## Bucking A Log

Bucking or cross-cutting is cutting a log into lengths. It is important to make sure your footing is firm and your weight is evenly distributed on both feet. When possible, the log should be raised and supported by the use of limbs, logs or chocks.

1. Follow the simple directions for easy cutting. When the log is supported along its entire length (see below image 1), it is cut from the top (over buck).

2. When the log is supported on one end (see below image 2), cut 1/3 the diameter from the underside (under buck). Then make the finished cut by over-bucking to meet the first cut.

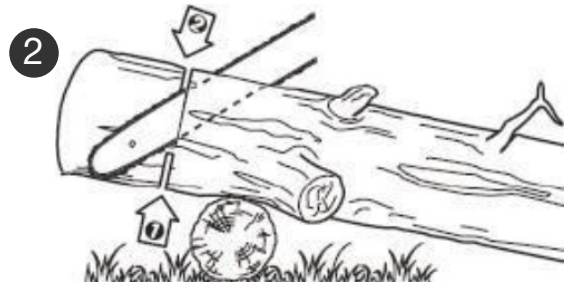

3. When the log is supported on both ends (see below image 1), cut 1/3 the diameter from the top (over buck). Then make the finished cut by under bucking the lower 2/3 to meet the first cut.

4. When bucking on a slope always stand on the uphill side of the log (figure below image 2). When “cutting through”, to maintain complete control release the cutting pressure near the end of the cut without relaxing your grip on the product handles. Don't let the chain contact the ground. After completing the cut, wait for the saw chain to stop before you move the product. Always stop the motor before moving from tree to tree.



5. Support small logs on a sawing stand or another log while bucking (see below image 1).

6. If the wood diameter is large enough for you to insert a soft bucking wedge without touching the chain, you should use the wedge to hold the cut open to prevent pinching (see below image 2).

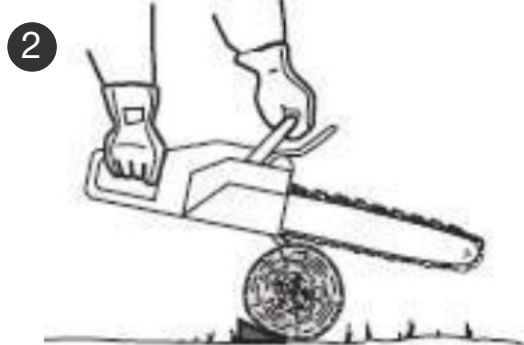
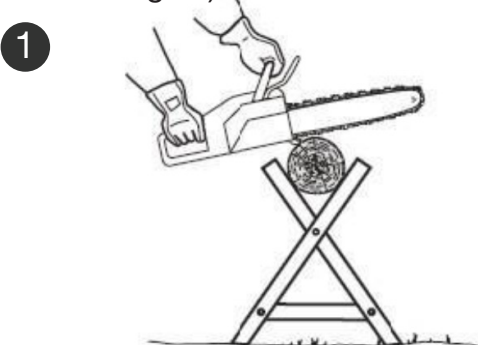



For more information, go to

[www.hyundaisupport.co.uk](http://www.hyundaisupport.co.uk)

# Maintenance And Care

## Maintenance Safety

 **IMPORTANT** - Routine and accurate maintenance is essential for maintaining original machine safety and performance levels.

 **WARNING** - Before cleaning or doing maintenance work, you need to unplug the chainsaw from the mains. You need to wear proper clothing and protective gloves whenever your hands are at risk.

 If there are worn or damaged parts, never use the machine. Faulty or worn-out parts must be replaced and not repaired. You must only use original spare parts. The use of non-original and/or incorrectly fitted parts will jeopardize the safety of the machine. This may also cause accidents or personal injuries for which the manufacturer is under no circumstance liable or responsible.

 Any maintenance operations or adjustments not explained in this manual must be carried out by your Dealer or a specialised Service Centre with the necessary knowledge and equipment to ensure that the work is done correctly maintaining the machine's original safety level. Any operations performed in unauthorised centres or by unqualified persons will invalidate the Warranty and all obligations and responsibilities of the Manufacturer

## Bar Maintenance

**WARNING! Make sure that the chainsaw is disconnected from the mains supply before continuing.**

Most guide bar problems can be prevented merely by keeping the product well maintained. Incorrect filing and non-standard cutter and depth gauge settings are the causes of most guide bar problems, primarily resulting in uneven bar wear. As the bar wears unevenly, the rails widen, which may cause the chain to clatter and make it difficult to complete straight cuts. If the guide bar is insufficiently lubricated and the product is operated with a saw chain which is too tight, this will contribute to rapid bar wear. To help minimise bar wear, maintenance of the guide bar as well as the saw chain, is recommended.

To keep the bar in good working order, you must follow these maintenance procedures.

1. After approximately 5 hours use, the bar should be turned, to ensure even wear on the top and bottom of the bar.
2. The bar rails should be cleaned every time the bar is turned, or the chain is removed. Using a suitable implement, clear any debris from the bar rails. This will keep the oil passages open and provide correct lubrication to the bar and chain.

## Contact Us

# Maintenance And Care

## Other Maintenance

1. Check the chain tension regularly and adjust as often as necessary to keep the chain snug on the bar. A new chain will require more frequent adjustment.
2. Check the mains cable before each use. Do not use the chainsaw if the cable is damaged in any way.
3. Always check the chain brake before each use.
4. Make sure that the automatic oiler system is working properly. Keep the oil tank filled with chain oil during use.

## Cleaning

1. After use, you must clean all excess sawdust, chippings and debris from the chainsaw, chain and chain bar using a dry cloth and a soft brush for areas that are hard to reach.
2. Keep the air vents (end of motor housing) clean to prevent the motor overheating. Use a cloth and brush.
3. Keep the main body of the chainsaw clean using a soft cloth.
4. Remove stubborn dirt with high pressure air (max. 3 bar).
5. Check for worn or damaged parts. Replace worn parts as necessary or contact an authorised service centre for repair before using the product again.

**NOTE:** Do not use chemicals, alkaline, abrasive or other aggressive detergents or disinfectants to clean this product, as they might be harmful to its surfaces.

### Sprocket Wheel

**NOTE:** It is not necessary to remove the saw chain to lubricate the sprocket. Lubrication can be done with the automatic lubrication system.

## Storage

- Always store the chainsaw with the guard in place. Avoid the sharp teeth of the saw chain when doing so. It is highly recommended to clean the chainsaw before storing it.
- Make sure that the chainsaw is stored out of the reach of children and do not stack other items on top of the machine when in storage.
- Never hang the chainsaw by the handle, always store the chainsaw on a flat and stable surface.

For more information, go to

[www.hyundaisupport.co.uk](http://www.hyundaisupport.co.uk)

# Maintenance And Care

## Transporting

- Always stop the chainsaw before putting a chainsaw down or carrying it. Carrying a chainsaw with the motor running is extremely dangerous.
- Accidental acceleration of the motor can cause the chain to rotate.
- **BY HAND:** When carrying your saw by hand, the chainsaw must be stopped and the saw must be in the proper position.

The chain guard (scabbard) should be over the chain and the guide bar, which should point backwards. When carrying your saw, the bar should be behind you.

- **BY VEHICLE:** When transporting in a vehicle, keep chain and bar covered with the chain guard. Properly secure your saw to prevent it moving around during transit, which in turn can cause spillage and damage to the saw.

## Checking Automatic Chain Lubrication

Regularly check the automatic chain lubrication function to prevent overheating and damage to the blade and saw chain. To do this, aim the sword tip against a smooth surface (board, part of a tree) and let the chainsaw run.

If an increasing trace of oil appears during this process, the automatic chain lubrication works perfectly.

Attention! Do not touch the surface. Keep a safe distance (about 20 cm).

## New Chain Bar And Chain

A dull chain will increase cutting time, and pressing a dull chain through wood will increase the vibrations transmitted to your hands. A saw with loose components or with damaged or worn AV buffers will also tend to have higher vibration levels.

Only use compatible chains to avoid damaging your machine. Using non-recommended replacement parts may result in damage to your machine or serious personal injury.

Replacement chain bars and chains can be obtained from HYUNDAI Power Products.

The bar needs to be renewed if:

- The guide groove of the bar is worn.
- The spur gear at the end of the guide bar is damaged or worn.

## Contact Us



# Maintenance And Care

## Removing Existing Bar And Chain

**WARNING!** Make sure that the chainsaw is disconnected from the mains supply before continuing.

1. Loosen the chain tension and then remove the housing cover by rotating the cover locking screw anticlockwise.
2. Using a pair of gloves, remove the existing bar and chain by pulling it towards you. Your local recycling centre can advise you on the best method of disposal.

**NOTE:** When you replace the bar, you will need to remove the wheel which is attached to it and fit it onto the new bar.

3. Make sure that any debris is cleared from the mechanism and housing using a soft brush. A clean paint brush is ideal.

## Fitting A New Bar And Chain

See page 22.

Be sure to fit adjuster bracket to new chain bar. See below.

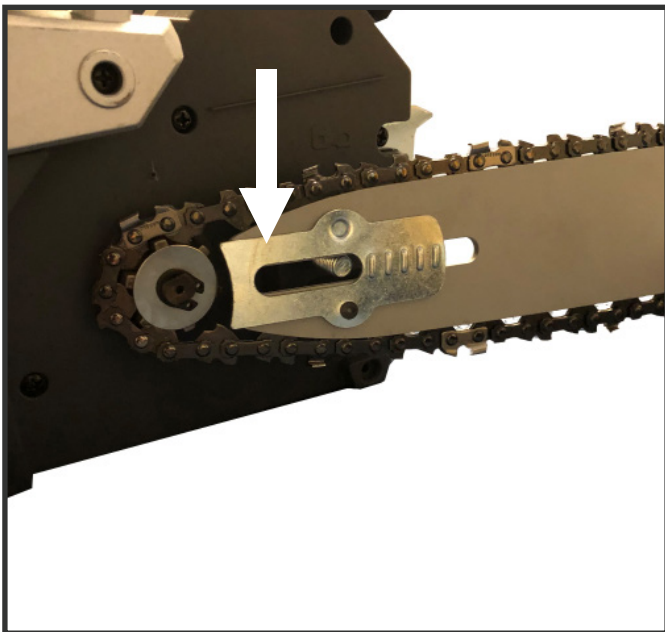

## Sharpening The Saw Chain

Effective working with the chainsaw is only possible if the saw chain is in good condition and sharp. This also reduces the risk of kickback.

The saw chain can be reground at every dealer. Do not try to sharpen the saw chain yourself if you do not have the proper tool and experience.

For more information, go to

[www.hyundaisupport.co.uk](http://www.hyundaisupport.co.uk)

# Specifications

Model	HYC1600E	HYC2400E
Rated Voltage	230-240V~50Hz	230-240V~50Hz
Motor Power Rating	1600W	2400W
Chain Speed	13m/s	15m/s
Chain Stopping Time (Kickback)	0.15 seconds	0.15 seconds
Maximum Cutting Length	335mm / 33.5cm	385mm / 38.5cm
Oil Type	Chain lubricating oil	Chain lubricating oil
Dimensions (L x W x H)	78 x 24 x 21cm	78 x 24 x 31cm
Weight	4.5kg	6.6kg
Vibration Level	5.15m/s <sup>2</sup> , K=1.5m/s <sup>2</sup>	6.55m/s <sup>2</sup> , K=1.5m/s <sup>2</sup>
Measured Sound Level	106dB(A)	104.5dB(A)
Guaranteed Sound Level	107dB(A)	107dB(A)
Guide Bar	350mm (14")	400mm (16")

The declared vibration emission value has been measured according to a standardized test procedure and can be used to compare one power tool with another.

The specified vibration emission value can also be used for an initial assessment of the exposure.

The vibration emission value may differ from the indication value during the actual use of the power tool, depending on the manner in which the power tool is used.

Try to minimize the impact of vibration as much as possible. Exemplary measures to reduce vibration exposure include wearing gloves while using the tool and limiting working time. In this case, all parts of the operating cycle are to be considered (for example, times when the power tool is switched off and those in which it is switched on, but runs without load).

## Contact Us

# Spare Parts

Only use original spare parts: The use of non-original and/or incorrectly fitted parts will jeopardize the safety of the machine, may cause accidents or personal injuries for which the Manufacturer is under no circumstance liable or responsible.

## HYC1600E

Description	Part Number
Chain	HYC1600ECHAIN
Chain Bar	HYC1600ECHAINBAR
Chain Scabbard	HYC1600ECHAINSCABBARD
Tensioning Wheel	HYC1600ETENSIONINGWHEEL
Housing Cover	HYC1600EHOUSINGCOVER
Oil Filler Cap	HYC1600EOILFILLERCAP

## HYC2400E

Description	Part Number
Chain	HYC2400ECHAIN
Chain Bar	HYC2400ECHAINBAR
Chain Scabbard	HYC2400ECHAINSCABBARD
Tensioning Wheel	HYC2400ETENSIONINGWHEEL
Housing Cover	HYC2400EHOUSINGCOVER
Oil Filler Cap	HYC2400EOILFILLERCAP

For more information, go to

[www.hyundaisupport.co.uk](http://www.hyundaisupport.co.uk)

# Disposal

## Environmental Protection

1. Environmental protection should be a priority of considerable importance when using the machine, for the benefit of both social coexistence and the environment in which we live. Try not to cause any disturbance to the surrounding area.
2. You must comply with local regulations and provisions for the disposal of packaging, oils, petrol, filters, damaged parts or any elements which have a strong impact on the environment. This waste must not be disposed of as normal waste. It needs to be separated and taken to specified waste disposal centres where the material will be recycled.
3. You must comply with local regulations for the disposal of waste materials after mowing.
4. When disposing, do not pollute the environment with the machine, but hand it over to a disposal centre, in accordance with the local laws in force.

## Recycling And Disposal



We do not offer a takeback scheme for the recovery of Waste Electrical Electronic Equipment (WEEE) & Batteries. Instead the responsibility to dispose of WEEE and or Batteries is passed onto you by us.

So when it becomes necessary to dispose of your machine you must take it to your local Civic Amenity Site. For further information please contact your local Authority for disposal advice.

You **MUST** make sure that all unused oil and fuel is disposed of correctly either beforehand or at your local Civic Amenity Site.

Under NO circumstances must any fuel or oil be put down any drains.

Certain products contain WEEE waste which should not be disposed of in your domestic waste.

You **MUST** recycle WEEE in accordance with your local authority or recycling centre.

Certain products contain batteries which should not be disposed of in your domestic waste.

You **MUST** recycle batteries in accordance with your local authority or recycling centre.

Unwanted packaging and materials should be stored and taken to a recycling centre so it can be disposed of in a manner which is compatible with the environment.

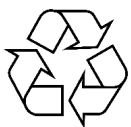

This symbol means you should 'Reduce - Reuse - Recycle'

We are a Member of the VALPAK National Compliance Scheme and our registration number is **RM08660**. For further information about disposal please contact your Local Authority.

You can also get more advice and guidance about recycling at the following website  
<http://www.recycle-more.co.uk>

Should you pass this product on to another user either sold or loaned, you **MUST** pass on this user manual. This will make sure that all other users can use and maintain this machine safely.

## Contact Us



[www.hyundaipowerproducts.co.uk](http://www.hyundaipowerproducts.co.uk)



01646 687 880



[aftersales@hyundaipowerproducts.co.uk](mailto:aftersales@hyundaipowerproducts.co.uk)

# Our Product Range

## Generators

Leisure Inverter, Petrol, Diesel And Built-In Motorhome Generators

## Pressure Washers

Petrol, Diesel And Electric Pressure Washers

## Water Pumps

Submersible, Clean And Dirty Water And Professional Chemical Water Pumps

## Lawnmowers

Petrol, Cordless, Electric, Roller, Self Propelled, Electric Start And Robotic Lawnmowers

## Grass Trimmers And Brush Cutters

Petrol, Cordless, Electric And Wheeled Grass Trimmers And Brush Cutters

## Chainsaws

Petrol, Cordless And Electric Chainsaws

## Hedge Trimmers

Petrol And Cordless Hedge Trimmers

## Leaf Blowers

Petrol, Electric, Cordless, Backpack And 3 -in-1 Leaf Blowers

## Log Splitters

Horizontal, Vertical, Petrol And Electric Log Splitters

## Wood Chippers

Petrol And Electric Start Wood Chippers

## Tillers

Petrol Garden Tiller And Cultivator

## Earth Augers And Trenchers

Petrol Earth Augers And Heavy Duty Trenchers

## Compactor Plates

Petrol Compactor Plates

## Cement Mixers

Portable Electric Cement Mixers

## Mini Dumpers

4-Wheel Drive Mini Dumpers And Tracked Dumpers

## Yard Sweeper

Self Propelled Yard Sweeper Power Brush

## Scarifiers

Petrol Lawn Scarifier And Aerator

## Stump Grinders

Petrol 4-Stroke Stump Grinders

## Welders And Plasma Cutters

MIG, TIG, MMA, ARC Welders And Plasma Cutters

## Power Tools And Tool Chests

Electric And Cordless Power Tools And Filled Tool Chests

## Vacuum Cleaners

Wet And Dry Vacuum Cleaners

## Engines

Petrol And Electric Start Engines

## Battery Chargers / Starters

6V, 12V, 24V Battery Chargers, Jump Starters And Hydraulic Floor Jack

## Air Compressors

Home, Domestic, DIY And Professional Use Air Compressors

## Lighting Towers

Mobile Lighting Towers With Diesel Generators

## Portable Power Stations

Camping Power Packs And Solar Chargers

## And More

We Are Constantly Expanding Our Range With New Products

If you would like more information on any of these products, please contact our sales team on 01646 687880 or visit our website [www.hyundaipowerproducts.co.uk](http://www.hyundaipowerproducts.co.uk)

For more information, go to

[www.hyundaisupport.co.uk](http://www.hyundaisupport.co.uk)

# Useful Information

## Check Out Our YouTube Channel

Our videos on YouTube include:

- Unboxing • Assembly of your machine • How to service your machine • Products in use
- 'How To' videos • Product features • And more.

Go to [www.hyundaipowerproducts.co.uk](http://www.hyundaipowerproducts.co.uk) or search 'Hyundai Power Products' in YouTube.

## Warranty

Proof of purchase will be required before you make a warranty claim.

Full warranty terms and conditions can be found on the HYUNDAI POWER PRODUCTS website: [www.hyundaipowerproducts.co.uk](http://www.hyundaipowerproducts.co.uk)

## Manual Updates

Our manuals are constantly being reviewed and updated. Should you find an error, omission or something unclear, please contact us for assistance.

We reserve the right to make any modifications without prior notice whenever necessary.

Our latest manuals are also placed online. All our manuals can be downloaded at: [www.hyundaipowerproducts.co.uk](http://www.hyundaipowerproducts.co.uk)

## Returning Your Product

If you are returning your product, please contact the dealer for their returns policy.

## Leaving A Review

We work very hard to give all of our customers the best possible service. If you have any problems, before leaving negative feedback, please contact us to give us a chance to resolve the issue. We would be delighted if you left us positive feedback!

To leave a review, please go to:

[uk.trustpilot.com/review/hyundaipowerequipment.co.uk](http://uk.trustpilot.com/review/hyundaipowerequipment.co.uk)

## Ordering Spare Parts

Only use original spare parts: The use of non-original and/or incorrectly fitted parts will jeopardize the safety of the machine, may cause accidents or personal injuries for which the Manufacturer is under no circumstance liable or responsible.

## Contact Us



[www.hyundaipowerproducts.co.uk](http://www.hyundaipowerproducts.co.uk)



01646 687 880



[aftersales@hyundaipowerproducts.co.uk](mailto:aftersales@hyundaipowerproducts.co.uk)





# Need Help? Talk To Our Experts

## Contact Us

---

Our friendly aftersales team will be more than happy to help you.

### Phone

Call our team on 01646 687880, open Monday-Friday 8.30am-5pm.

### Email

[aftersales@hyundaipowerproducts.co.uk](mailto:aftersales@hyundaipowerproducts.co.uk)

### Online Live Chat

Go to [www.hyundaipowerproducts.co.uk](http://www.hyundaipowerproducts.co.uk)

Live chat is open Monday-Friday from 8.30am-5pm.

**As soon as you have purchased the machine, we recommend that you fill out the following. If you need to contact an authorised dealer or customer service for information on servicing, you may need to provide the following information.**

**The model number and serial number can be found on the grey specification sticker.**

Date Of Purchase: .....

Dealer Name:.....

Dealer Phone:.....

Model Number:.....

Serial Number:.....



# Declaration Of Conformity

## EC Declaration of Conformity

### Product Details

Brand: Hyundai  
Model: HYC2400E  
Description: 16" 40cm Electric Chainsaw 2400W

### Product Details

Brand: Hyundai  
Model: HYC1600E  
Description: 14" 35cm Electric Chainsaw 1600W

**We hereby declare that the machine detailed in this declaration complies to all the relevant provisions of the following EC directives.**

- 2006/42/EC The Machinery Directive
- 2014/30/EU Annex II Electromagnetic Compatibility Directive
- 2000/14/EC & 2005/88/EC Outdoor Noise Emissions Directive
- ROHS Directive 2011/65/EU
- 1907/2006 REACH Annex XVII & SVHC as amended by EU 2022/2400

**And is in conformity with the applicable requirements of the following documents:**

- EN ISO 3744:1995
- EN ISO 9207:1995
- EN IEC 55014-1:2021
- EN IEC 55014-2:2021
- EN IEC 61000-3-2:2019/A1:2021
- EN IEC 61000-3-3:2013/A2:2021
- IEC 62841-1: 2014, COR1:2014, COR2:2015

Notified Body: TÜV SUD Shanghai Branch.

Model	Type	Motor watts	Measured Sound Power	Guaranteed Sound Power
HYC1600E	Electric chainsaw	1600w	106dB(A)	107dB(A)
HYC2400E		2400w	104.5dB(A)	107dB(A)

### Name and address of technical documentation holder and EU distributor:

Genpower Ltd, Isaac Way, Pembroke Dock, Pembrokeshire, SA72 4RW, UK.

Signed by:



Roland Llewellyn, Managing Director

Date: 10/12/2019



## Contact Us

# HYUNDAI

POWER PRODUCTS



GENUINE PRODUCT OF  
HYUNDAI CORPORATION

For Inquiries, Please Contact:  
GENPOWER LTD  
Isaac Way, London Road,  
Pembroke Dock, UK, SA72 4RW.  
T: +44 (0) 1646 687 880  
E: [info@hyundaipowerproducts.co.uk](mailto:info@hyundaipowerproducts.co.uk)  
[www.hyundaipowerproducts.co.uk](http://www.hyundaipowerproducts.co.uk)

