

Panasonic®

Owner's Manual

Digital Camera

Model No. DC-G100



LUMIX

Please read these instructions carefully before using this product, and save this manual for future use.

A firmware update has been made available to improve camera capabilities and to add functionality.

- For information about functions that have been added or modified, refer to the pages for "Firmware Update".

Click here to move to "Firmware Update".

Register online at

<http://shop.panasonic.com/support>

(U.S. customers only)

DVQP2173ZB

M0620KZ1110

Dear Customer,

Thank you for choosing Panasonic!

You have purchased one of the most sophisticated and reliable products on the market today. Used properly, we're sure it will bring you and your family years of enjoyment. Please take time to fill in the information below. The serial number is on the tag located on the underside of your camera. Be sure to **retain this manual** as your convenient camera information source.

Date of Purchase	Dealer Phone No.
Dealer Purchased From	Model No.
Dealer Address	Serial No.

Please note that the actual controls and components, menu items, etc. of your Digital Camera may look somewhat different from those shown in the illustrations in this Owner's Manual.

Carefully observe copyright laws.





Recording of pre-recorded tapes or discs or other published or broadcast material for purposes other than your own private use may infringe copyright laws. Even for the purpose of private use, recording of certain material may be restricted.

❖ Finding the Information You Need

You can find the information you need by looking at the following pages in this document.

Contents	→6
Contents by Function	→16
Names of Parts	→26
Menu Guide	→307
Index	→500

Notification classification symbols

	To confirm prior to using the function
	Hints for better use of the camera and tips for recording
	Notifications and supplementary items regarding specifications
	Related information and page number

- The images and drawings of this document are an illustration to explain the functions.
- Description in these operating instructions is based on the interchangeable lens (H-FS12032).

Chapters

1. Introduction	20
2. Getting Started	30
3. Basic Operations	48
4. Recording Mode	74
5. Image Recording	117
6. Focus/Zoom	124
7. Drive/Shutter/Image Stabilizer	157
8. Brightness (Exposure)/Coloring/ Picture effect	207
9. Flash	226
10. Recording Videos	238
11. Playing Back and Editing of Images	270
12. Camera Customization	291
13. Menu Guide	307
14. Wi-Fi/Bluetooth	371
15. Connecting to Other Devices	432
16. Materials	447

Contents

About Operating Instructions	3
Chapters	5
Contents by Function	16

1. Introduction **20**

Before Use	20
Standard Accessories	22
Lenses That Can Be Used	23
Memory Cards That Can Be Used	24
Names of Parts	26
Camera	26
Lens	28
Tripod grip	29
Monitor Displays	29

2. Getting Started **30**

Attaching a Shoulder Strap	30
Charging the Battery	31
Battery Insertion	31
Charging battery	33
Notifications Regarding Charging	35
[Economy]	37
Inserting Cards (Optional)	39
Formatting Cards (Initialization)	40
Attaching a Lens	41
Extending/retracting the lens <when the interchangeable lens (H-FS12032) is attached>	43
Adjusting the Monitor Direction and Angle	44
Setting the Clock (When Turning On for the First Time)	45

3. Basic Operations 48

Basic Recording Operations	48
How to Hold the Camera.....	48
Taking Pictures.....	50
Recording Videos.....	51
Selecting the Recording Mode.....	52
Camera Setting Operations	53
Display Settings	55
Adjusting the Viewfinder Diopter.....	55
Switching Between the Monitor and Viewfinder.....	56
Switching the Display Information.....	58
Quick Menu.....	61
Monitor recording information screen	63
Menu Operation Methods	65
[Reset].....	67
Recording Using Touch Functions	68
Touch AF/Touch Shutter.....	68
Touch AE.....	69
Recording with the Tripod grip	70
Attaching the Hand Strap.....	70
Attaching the camera to a tripod grip.....	71
Using as a grip.....	72
Using as a tripod.....	73

4. Recording mode 74

Intelligent Auto Mode	74
[Intelligent Auto] menu	79
Taking pictures with different color tones, degrees of blurriness, and brightness	81
Self Shot Mode ([Self Shot])	83
Built-in microphone setting ([Self Shot]).....	86
4K Selfie.....	87
Program AE Mode.....	91
Aperture-Priority AE Mode	93
Shutter-Priority AE Mode	96
Manual Exposure Mode	98
Live View Composite Recording	101
Preview Mode	104
Scene Guide Mode	105
Types of Scene Guide Mode.....	107
Creative Control Mode	110
Types and adjustments of filter effects.....	111
Taking pictures with different degrees of blurriness and brightness	115

5. Image Recording 117

[Aspect Ratio].....	117
[Picture Size].....	118
[Quality].....	119
[Folder / File Settings]	121
[No.Reset]	123

6. Focus/Zoom **124**

Selecting the Focus Mode	124
Using AF	126
[AF Sensitivity(Photo)]	128
Selecting the AF Mode.....	129
[Face/Eye Detection].....	131
[Tracking]	133
[49-Area]	135
Custom Multi (Horizontal, Vertical, Center).....	136
Custom Multi (C1 to C3)	138
[1-Area]	139
[Pinpoint].....	140
Moving the AF Area by Touch	142
Optimizing the focus and brightness to the touched position.....	142
Moving the AF Area during Viewfinder Display	144
Record Using Manual Focus.....	146
Recording with Zoom	151
Extended Tele Conversion	152
[Digital Zoom]	155
Power Zoom Lens.....	156

7. Drive/Shutter/Image Stabilizer **157**

Selecting the Drive Mode.....	157
Taking Burst Pictures	158
4K Photo Recording.....	162
Selecting Pictures from a 4K Burst File	168
Picture Selection Operations	170
Post-Focus Recording	176
Selecting the Focus Point for the Picture to Save.....	179
Focus Stacking	181
Recording Using the Self-timer	184
Recording with Time Lapse Shot	187
Recording with Stop Motion Animation	190
Time Lapse Shot/Stop Motion Animation Videos	193
Bracket Recording	195
[Silent Mode]	201
[Shutter Type].....	202
Image Stabilizer	204
Image Stabilizer Settings	205

8. Brightness (Exposure)/Coloring/Picture effect 207

[Metering Mode]	207
Exposure Compensation.....	208
Locking Focus and Exposure (AF/AE Lock)	210
ISO Sensitivity.....	212
White Balance (WB).....	215
Adjusting the White Balance	219
[Photo Style].....	221
[Filter Settings].....	224
[Simultaneous Record w/o Filter].....	225

9. Flash 226

Using a Flash	226
Setting Flash	227
[Flash Mode]	227
[Flash Adjust.]	231
[Flash Synchro]	232
[Auto Exposure Comp.].....	233
[Red-Eye Removal].....	233
Recording Using a Wireless Flash.....	234

10. Recording Videos **238**

Recording Videos.....	238
Taking pictures while a video is being recorded.....	242
Creative Video Mode	244
[4K Live Cropping]	247
Slow & Quick Mode.....	250
Slow & Quick Menu.....	253
Snap Movies	255
Video Settings (Auto Focus)	259
[Continuous AF]	259
[AF Custom Setting(Video)]	260
Video Settings (Brightness)	261
[Luminance Level].....	261
[ISO Sensitivity (video)].....	262
Video Settings (Audio)	263
[Sound Rec Level Disp.]	263
[Sound Rec Level Adj.].....	263
[Wind Noise Canceller]	264
[Lens Noise Cut]	264
[Built-in Mic]	265
[Built-in Mic Indicator].....	266
Video Settings (Display).....	267
[Zebra Pattern].....	267
[Frame Marker]	268
Log Recording.....	269

11. Playing Back and Editing of Images **270**

Playing Back Pictures	270
Playing Back Videos	272
Extracting a Picture	274
Switching the Display Mode	275
Enlarged Display	275
Thumbnail Screen	276
Calendar Playback	277
Group Images	278
Deleting Images	279
[Light Composition]	280
[Sequence Composition]	282
[Clear Retouch]	284
[RAW Processing]	286
[Video Divide]	290

12. Camera Customization **291**

Fn Buttons	292
[Dial Operation Switch]	297
Quick Menu Customization	299
Custom Mode	303
My Menu	305

13. Menu Guide	307
List of Menu	308
Menus displayed in specific recording modes	312
[Intelligent Auto] menu	312
[Creative Video] menu	312
[Slow & Quick] menu.....	313
[Scene Guide] menu	313
[Creative Control] menu	313
[Rec] Menu.....	314
[Motion Picture] Menu	327
[Custom] Menu.....	331
[Setup] Menu.....	352
[Playback] Menu	360
Entering Characters.....	370
14. Wi-Fi/Bluetooth	371
Connecting to a Smartphone	373
Operating the Camera with a Smartphone	386
Displaying still pictures on a TV	398
Sending Images from the Camera.....	400
Wi-Fi Connections.....	418
Send Settings and Selecting Images.....	424
[Wi-Fi Setup] Menu	427
15. Connecting to Other Devices	432
Viewing on a TV	434
Recording while monitoring camera images	437
Importing Images to a PC	438
Copying Images to a PC.....	438
Installing Software.....	440
Storing on a Recorder.....	443
Printing.....	444

16. Materials **447**

Using Optional Accessories	447
External Flash (optional)	447
External Microphones (Optional)	448
AC Adaptor (Optional)/DC Coupler (Optional)	451
Monitor/Viewfinder Displays.....	452
Recording Screen	452
Playback Screen	457
Message Displays.....	460
Troubleshooting	463
Cautions for Use	474
Number of Pictures That Can Be Taken and Available Recording Time with the Battery	484
Number of Still Images That Can Be Taken and Video Recording Time with Cards.....	487
List of Functions That Can Be Set in Each Recording Mode.....	488
Specifications.....	492
Index	500
Trademarks and Licenses.....	507

Contents by Function

Power Source

Charging	→31
Charging error	→34
Battery indication	→35
Power save function	→37
Number of pictures that can be taken, available recording time	→484

Card

Cards that can be used	→24
[Format]	→40
Folder structure	→439
[Folder / File Settings]	→121
[No.Reset]	→123
Entering characters	→370
Number of pictures, length of recording time	→487

Lens

Attaching	→41
-----------	-----

Tripod Grip

Attaching, usage	→70
------------------	-----

Basic Settings

[Language]	→358
[Clock Set]	→45
[World Time]	→352
[Beep]	→354
[Reset]	→67

Viewfinder

Diopter adjustment	→55
Eye sensor	→56
[Eye Sensor AF]	→332

Display

Recording screen	→452
Playback screen	→457
Monitor/Viewfinder	→29 →452
Monitor recording information screen	→63 →456
Switching display	→58
Monitor/viewfinder adjustment	→356
Monitor/viewfinder luminance	→356
Display speed	→355
Level gauge	→59
Grid lines	→343
[Histogram]	→343
[Highlight]	→344

AF/MF

Focus mode	→124
[Continuous AF]	→259
Selecting the AF mode	→129
Face/eye detection	→131
Movement tracking	→133
[AF-ON]	→211
Setting the AF sensitivity	→128 →327
AF/AE Lock	→210
Touch AF	→68 →142
[Touch Pad AF]	→144
[AF Assist Lamp]	→333
[MF]	→146
[MF Guide]	→345
[MF Assist]	→336
[Peaking]	→342

Image Stabilizer

[Stabilizer]	→204
[E-Stabilization (Video)]	→205

Drive

Drive mode	→157
[Burst]	→158
[4K PHOTO]	→162
[Post Focus]	→176
[Self Timer]	→184
[Time Lapse Shot]	→187
Recording with Stop Motion Animation	→190

Image Quality

[Picture Size]	→118
[Quality]	→119
RAW	→119
JPEG	→119
[Aspect Ratio]	→117
[White Balance]	→215
[Photo Style]	→221
[Filter Settings]	→224
[Color Space]	→315
[Highlight Shadow]	→316
[i.Dynamic]	→317
[i.Resolution]	→317
[Long Shtr NR]	→320
[Shading Comp.]	→320
[Diffraction Compensation]	→321
[HDR]	→323

Taking Pictures

Self Shot Mode	→83
Recording mode	→52
Quick menu	→61
Zoom	→151
Extended Tele Conversion ([Rec])	→152
Bracket recording	→195
Time recording	→100
Live View Composite Recording	→101
[Multi Exp.]	→325
[Shutter Type]	→202
[Silent Mode]	→201
Screen display	→452

Exposure

[Exposure Comp.]	→208
Program Shift	→92
Preview mode	→104
[Metering Mode]	→207
AE Lock	→210
[One Push AE]	→294
[Touch AE]	→69
ISO Sensitivity	→212
[Extended ISO]	→331

Flash

[Flash Mode]	→227
[Flash Adjust.]	→231
[Flash Synchro]	→232
[Wireless Flash Setup]	→234
External flash	→447

Video Recording

Video recording	→238
Taking pictures while a video is being recorded	→242
[Ex. Tele Conv.] ([Motion Picture])	→154
Creative Video mode	→244
[4K Live Cropping]	→247
Slow & Quick Mode	→250
[Snap Movie]	→255
Log recording (V-Log L)	→269

Display (Video)

[Zebra Pattern]	→267
[Frame Marker]	→268

Image Quality (Video)

[Rec Quality]	→239
[Flkr Decrease]	→329

Exposure (Video)

Exposure settings	→244
[S&Q Exposure Mode]	→253
[Luminance Level]	→261

Audio

[Sound Rec Level Disp.]	→263
[Sound Rec Level Adj.]	→263
Mute	→263
Wind noise reduction	→264
Built-in microphone setting ([Self Shot])	→86
[Built-in Mic]	→265
[Built-in Mic Indicator]	→266
External microphone	→448
[Wind Cut]	→450

Playback

[Auto Review]	→340
Playing back pictures	→270
Playing back videos	→272
Thumbnail display	→276
Calendar display	→277
Enlarged display	→275
Group images	→278
Saving 4K photos	→168
Viewing on a TV	→434
Deleting	→279
Screen display	→457
[Slide Show]	→361

Editing of Images

Focus Stacking	→181
[Light Composition]	→280
[Sequence Composition]	→282
[Clear Retouch]	→284
[RAW Processing]	→286
[Protect]	→362
[Cropping]	→367
[Rating]	→362
[Resize]	→366
[Rotate]	→367
[Video Divide]	→290

Customization

[Custom] menu	→331
Function button	→292
Custom recording mode	→303
My Menu	→305
Quick menu	→299
Dial operation	→297

Connecting with Other Devices

Sending images (PC)	→438
Printing	→444
Viewing on a TV	→434
HDMI output	→432 →437

Wi-Fi/Bluetooth

Bluetooth connection	→375
Wi-Fi connection	→380 →418
[Wi-Fi Setup]	→427
Smartphone app “LUMIX Sync”	→373
[Remote shooting]	→387
Location information	→395
Sending images ([Smartphone])	→391 →404
Sending images ([PC])	→407
Sending images ([Printer])	→410
Sending images ([AV device])	→412
Sending images ([Web service])	→414
Sending images ([Cloud Sync. Service])	→416
“LUMIX CLUB”	→428

Software

“PHOTOfunSTUDIO”	→441
“SILKYPIX”	→442

Maintenance

[Pixel Refresh]	→359
-----------------	------

1. Introduction

Before Use

❖ Firmware of Your Camera/Lens

Firmware updates may be provided in order to improve camera capabilities or to add functionality. For smoother recording, we recommend updating the firmware of the camera/lens to the latest version.

- **For the latest information on the firmware or to download/update the firmware, visit the following support site:**

<https://panasonic.jp/support/global/cs/dsc/>

(English only)

- To check the firmware version of the camera/lens, attach the lens to the camera and select [Version Disp.] in the [Setup] menu.
- This document provides explanations for camera firmware version 1.0.

❖ Handling of the Camera

When using the camera, be careful not to drop it, bump it, or apply undue force. These may cause malfunction or damage to the camera and lens.

The camera is not dust resistant, splash resistant, or waterproof. Avoid using the camera in places with excessive dust or sand, or where water can come into contact with the camera.

If sand, dust, or liquids such as water droplets adhere to the monitor, wipe them off with a dry soft cloth.

– Touch operations may be incorrectly recognized.

Do not place a hand inside the camera mount.

This may cause a failure or damage because the sensor is a precision device.

❖ Condensation (When the Lens, the Viewfinder or Monitor is Fogged Up)

- Condensation occurs when there are temperature or humidity differences. Take care as this may lead to soiling, mold, and malfunctions in the lens, viewfinder, and monitor.
- If condensation occurs, turn off the camera and leave it for approx. 2 hours. The fog will disappear naturally when the temperature of the camera becomes close to the ambient temperature.

❖ Be Sure to Perform Trial Recording in Advance

Perform trial recording in advance of an important event (wedding, etc.) to check that recording can be performed normally.

❖ No Compensation Regarding Recording

Please note that compensation cannot be provided in the event that recording could not be performed due to a problem with the camera or a card.

❖ Be Careful with Regard to Copyrights

Under copyright law, you may not use the images and audio you have recorded for other than personal enjoyment without the permission of the copyright holder. Be careful because there are cases where restrictions apply to recording even for the purpose of personal enjoyment.

❖ Also Read “Cautions for Use” (→[474](#))

Standard Accessories

Check that all the accessories are supplied before using the camera.

- The accessories and their shape will differ depending on the country or area where the camera was purchased.

For details on the accessories, refer to "Owner's Manual <Basic>" (supplied).

- **Digital camera body** is referred to as camera in this document.
- **Battery pack** is referred to as **battery pack** or **battery** in this document.
- **The memory card is optional.**
- Please dispose of all packaging appropriately.
- Keep small parts in a safe place out of the reach of children.

Lenses That Can Be Used

This unit can use the dedicated lenses compatible with the Micro Four Thirds™ System lens mount specification (Micro Four Thirds mount).



You can also use a lens of any of the following standards by attaching a mount adaptor.

Lens	Mount adaptor
Four Thirds™ mount specification lens 	Mount Adaptor (DMW-MA1: optional)
Leica M Mount interchangeable lens	M Mount Adaptor (DMW-MA2M: optional)
Leica R Mount interchangeable lens	R Mount Adaptor (DMW-MA3R: optional)

❖ About the lens and functions

Depending on the lens used, certain functions, such as Auto Focus, Image Stabilizer, and zoom functions, may be disabled or operate differently.

- Refer to catalogs/websites for most current information regarding supported lenses.

<https://panasonic.jp/support/global/cs/dsc/>

(English only)



- The focal length noted on the Micro Four Thirds lens is equivalent to double when converted to the 35 mm film camera. (It will be equivalent to 100 mm lens when a 50 mm lens is used.)

Memory Cards That Can Be Used





You can use the following memory cards with this camera.

- SD memory card, SDHC memory card, and SDXC memory card are referred to by the generic name of **card** in this document.

SD memory card (512 MB to 2 GB)	<ul style="list-style-type: none"> • The camera supports SDHC/SDXC memory cards compliant with UHS Speed Class 3 of the UHS-I standard. • Operation with the Panasonic cards on the left has been verified.
SDHC memory card (4 GB to 32 GB)	
SDXC memory card (48 GB to 128 GB)	

When using the following functions, use cards that have the correct SD Speed Class, UHS Speed Class and Video Speed Class.

- Speed classes are standards to guarantee the minimum speed necessary for continuous writing.

Function	[Rec Quality]	Speed Class	Example of indication
Video recording	[FHD]/[HD]	Class 4 or higher	CLASS  
	[4K]	UHS Speed Class 3	
[4K PHOTO]/ [Post Focus]	—	Video Speed Class 30 or higher	





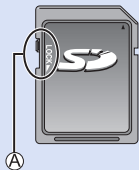

- You can prevent the writing and deleting of data by setting the write-protect switch (A) on the card to "LOCK".
- The data stored on a card may be damaged due to electromagnetic waves, static electricity or a failure of the camera or card. We recommend backing up important data.
- Keep the memory card out of reach of children to prevent swallowing.

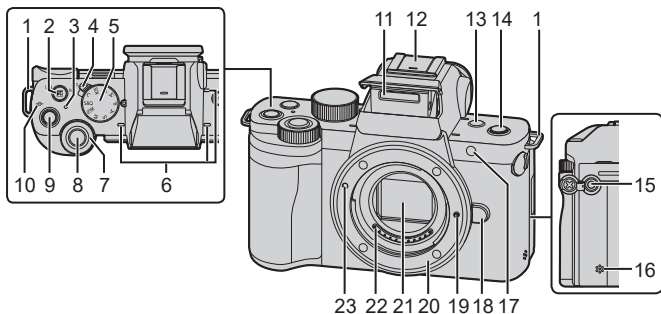

Names of Parts

Camera



1	Shoulder strap eyelet (→30)		
2	[] (Exposure compensation) button (→208)/ Fn button (Fn1) (→292)	12	Hot shoe (hot shoe cover) (→447) • Keep the hot shoe cover out of reach of children to prevent swallowing.
3	Charging lamp (→34)/ WIRELESS connection lamp (→354, 371)	13	[LVF] button (→56) Fn button (Fn3) (→292)
4	Camera on/off switch (→45)	14	[] ([Send Image (Smartphone)]) button (→406)/ Fn button (Fn4) (→292)
5	Mode dial (→52)	15	[MIC] socket (→448)
6	Stereo microphone (→263) • Do not block the microphone with a finger. Audio will be difficult to record.	16	Speaker (→354)
7	Front dial (→53)	17	Self-timer light (→184)/ AF assist light (→333)
8	Shutter button (→50)	18	Lens release button (→42)
9	Video rec. button (→51, 238)	19	Lens lock pin
10	[] (Recording distance reference mark) (→150)	20	Mount
11	Flash (→48, 226)	21	Sensor
		22	Contact points
		23	Lens fitting mark (→41)

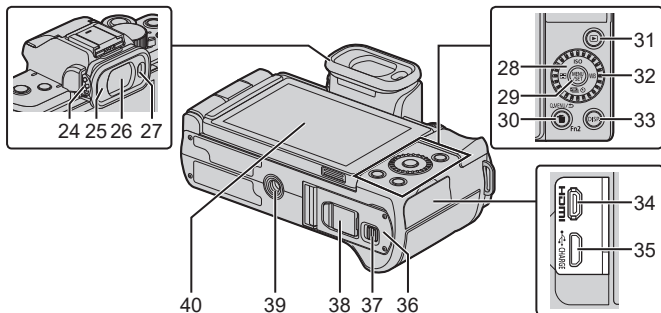

24	Diopter adjustment dial (→55)	35	[USB/CHARGE] socket (→33, 433)	
25	Eye cup (→476)	36	Card/Battery door (→31, 39)	
26	Viewfinder (→56, 452)	37	Release lever (→31, 39)	
27	Eye sensor (→56)	38	DC Coupler cover (→451) • When using an AC adaptor, ensure that the Panasonic DC Coupler (DMW-DCC11: optional) and AC Adaptor (DMW-AC10: optional) are used.	
28	Cursor buttons (→54)		39	Tripod mount (→70, 481) • If you attempt to attach a tripod with a screw length of 5.5 mm (0.22 inch) or more, you may not be able to securely fix it in place or it may damage the camera.
	[ISO] (ISO sensitivity) (▲) (→212)			
	[WB] (White balance) (▶) (→215) [4K] (Drive mode) (▼) (→157) [AF] (AF Mode) (◀) (→126)			
29	[MENU/SET] button (→54, 65)	40	Monitor (→29, 452)/ Touch screen (→54)	
30	[] (Delete) button (→279)/ [Q.MENU] button (→61)/ [] (Cancel) button (→66)/ Fn button (Fn2) (→292)			
	31	[] (Playback) button (→270)		
32	Control dial (→53)			
33	[DISP.] button (→58)			
34	[HDMI] socket (→432)			

→ • Use [Fn5] to [Fn9] (Touch Icons) (→296)

Lens

H-FS12032

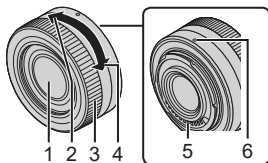

1	Lens surface
2	Tele
3	Zoom ring (→151)
4	Wide
5	Contact point
6	Lens fitting mark (→41)

Tripod grip

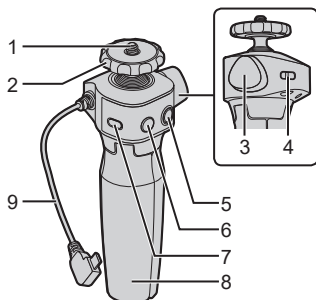

1	Camera screw
2	Camera stand
3	Fastening knob
4	Hand strap eyelet
5	Video rec. button
6	Shutter button
7	Sleep button
8	Grip
9	Connection cable

- For information on how to attach the camera and operate the tripod grip, refer to page [70](#).

Monitor Displays

At the time of purchase, the monitor displays the following icons.

- For information about the icons other than those described here, refer to page [452](#).

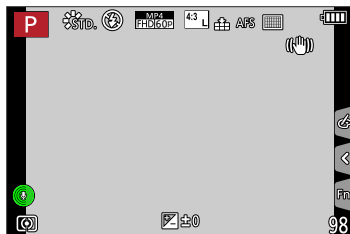

2. Getting Started

Attaching a Shoulder Strap

Attach a shoulder strap to the camera with the following procedure to prevent it from dropping.

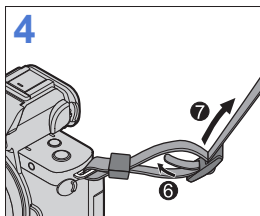
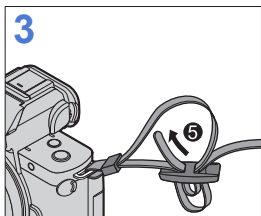
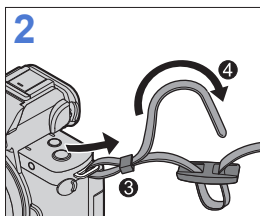
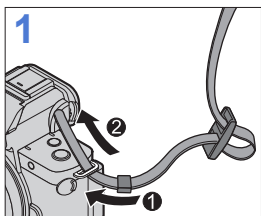

- Pull the shoulder strap and check that it will not come out.
- Attach the opposite end of the shoulder strap with the same procedure.
- Use the shoulder strap around your shoulder.
 - Do not wrap the strap around your neck.
It may result in injury or accident.
- Do not leave the shoulder strap where an infant can reach it.
 - It may result in an accident by mistakenly wrapping around the neck.

Charging the Battery

Insert the battery in the camera and charge it.

- The battery that can be used with the camera is DMW-BLG10. (As of June 2020)



- The battery is not charged at the time of purchase. Charge the battery before use.
- Check that this unit is turned off.

Battery Insertion

- Always use genuine Panasonic batteries (DMW-BLG10).
- If you use other batteries, we cannot guarantee the quality of this product.

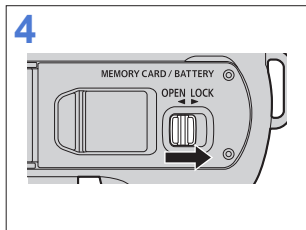
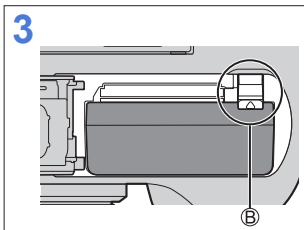
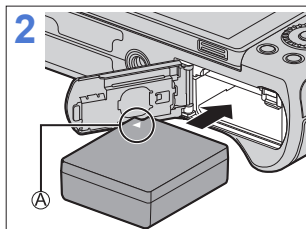
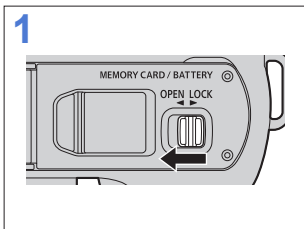

Ⓐ Make sure to insert the battery in the correct orientation.

Ⓑ Check that the lever is holding the battery in place.

❖ Removing the Battery

Push the lever in the direction of the arrow.

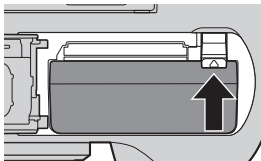

- Remove the battery after use.
(The battery will drain if left inserted in the camera for a long period of time.)
- To remove the battery, turn the camera off and wait until the LUMIX indicator on the screen goes off. (Failure to wait may cause the camera to malfunction and may damage the card or recorded data.)
- The battery becomes warm after use, during charging, and immediately after charging.
The camera also becomes warm during use. This is not a malfunction.
- Be careful when removing the battery as the battery will jump out.

Charging battery

Charging time
Approx. 190 min.

- Using the camera body and the supplied AC adaptor.
- The indicated charging time is for when the battery has been discharged completely.

The charging time may vary depending on how the battery has been used.

The charging time for the battery in hot/cold environments or a battery that has not been used for a long time may be longer than normal.

- Use the products supplied with the camera for charging.

1 Set the camera on/off switch to [OFF].

- The camera cannot be charged when it is turned on.

2 Insert the battery into the camera.

3 Connect the camera [USB/CHARGE] socket and the AC adaptor using the USB connection cable.

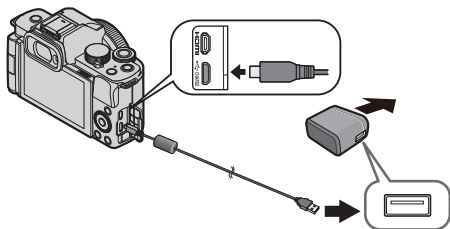

- Hold the plugs and insert them straight in or pull them straight out. (Inserting these at an angle may cause deformation or malfunction)

4 Insert the AC adaptor into the electrical outlet.

- The charging lamp blinks red and charging begins. (→34)

❖ Charging lamp indications

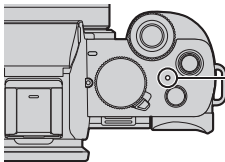

Charging lamp (Red)

On: Charging in progress

Off: Charging complete

Flashing: Charging error



- You can also charge the battery by connecting a USB device (PC, etc.) and the camera with the USB connection cable.

In that case, charging may take a while.



- Do not use any other USB connection cables except the supplied one. This may cause malfunction.
- Do not use any other AC adaptors except the supplied one. This may cause malfunction.
- After charging, disconnect the connection to the power source.
- When the charging lamp is blinking, the battery is not charging properly.
 - The temperature of the battery or surroundings is either too high or too low. Try charging at an ambient temperature between 10 °C and 30 °C (50 °F and 86 °F).
 - The terminals of the battery are dirty.
Remove the battery and wipe off the dirt with a dry cloth.
- Even when the camera on/off switch is set to [OFF] thus turning the camera off, it consumes power.
When the camera will not be used for a long time, remove the power plug from the electrical outlet in order to save power.

Notifications Regarding Charging

❖ Power Indications

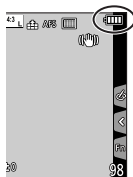

	75% or higher
	74% to 50%
	49% to 25%
	24% or below
 Blinking in red	Low battery <ul style="list-style-type: none"> • Charge or replace the battery.

- The battery level indicated on the screen is approximate.



- **To ensure that safe products are used, we recommend that a genuine Panasonic battery pack is used. There is a possibility that other battery packs may lead to fire or explosion. Please be advised that we are not liable for any accident or failure occurring as a result of use of a counterfeit battery pack.**
- Do not leave any metal items (such as clips) near the contact areas of the power plug.
Otherwise, a fire and/or electric shocks may be caused by short-circuiting or the resulting heat generated.
- Do not use the AC adaptor or USB connection cables on other devices.
This may cause a malfunction.
- Do not use USB extension cables or USB conversion adaptors.
- The battery can be charged even when it still has some charge left, but it is not recommended that the battery charge be frequently topped up while the battery is fully charged.
(Since characteristic swelling may occur.)
- If there is a power outage or other problem with the electrical outlet, then charging may not complete successfully.
Reconnect the power plug.
- Do not connect to keyboard or printer USB ports, or to USB hubs.
- If the connected PC enters sleep status, then charging may stop.

[Economy]

This is a function to automatically turn the camera to sleep (power save) status or turn off the viewfinder/monitor if no operation is performed for a set time. Reduces battery consumption.

 → [] → Select [Economy]

[Sleep Mode]	Sets the amount of time until the camera is put to sleep.	
[Sleep Mode(Wi-Fi)]	Sets the camera to sleep 15 minutes after being disconnected from Wi-Fi.	
[Auto LVF/Monitor Off]	Sets the amount of time it takes for the viewfinder/monitor to turn off. (The camera is not turned off.)	
[Power Save LVF Shooting]	Puts the camera to sleep when the recording screen is being displayed on the monitor when automatic viewfinder/monitor switching is active.	
	[Time]	Sets the amount of time until the camera is put to sleep.
	[Display]	Sets the screen where the camera is put to sleep. [Only Monitor Info.]: Puts the camera to sleep only when the control panel (→58) is displayed. [All Live View]: Puts the camera to sleep from any screen during recording standby.

- To recover from [Sleep Mode], [Sleep Mode(Wi-Fi)], or [Power Save LVF Shooting], perform one of the following operations:
 - Press the shutter button halfway.
 - Set the camera on/off switch to [OFF] and then [ON] again.
- To recover from [Auto LVF/Monitor Off], press any button.



- [Economy] is not available in the following cases:
 - While connected to a PC or printer
 - During video recording/video playback
 - When recording with [4K Pre-Burst]
 - During a [Time Lapse Shot]
 - When recording with [Stop Motion Animation] (when [Auto Shooting] is set)
 - When recording with [Live View Composite]
 - When recording with [Multi Exp.]
 - During a [Slide Show]
 - During HDMI output for recording

Inserting Cards (Optional)

-  • Make sure that the camera is turned off.

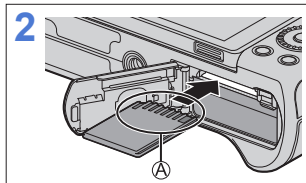
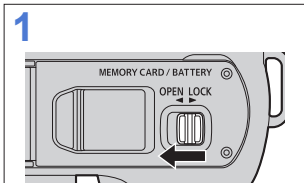

- A Do not touch the card connection contacts.

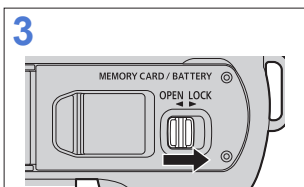

❖ Card Access Indications

The access indication displays red while the card is being accessed.



❖ Removing a Card

Push the card until it clicks and then pull the card out straight.

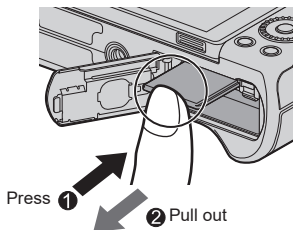



- To remove the card, turn the camera off and wait until the LUMIX indicator on the screen goes off. (Failure to wait may cause the camera to malfunction and may damage the card or recorded data.)
- The card may be warm just after the camera has been used. Be careful when removing.
- **Do not perform the following operations during access. The camera may operate incorrectly or the card and recorded images may be damaged.**
 - Turn off the camera.
 - Remove the battery or card, or disconnect the AC adaptor (optional) or DC coupler (optional).
 - Subject the camera to vibration, impacts, or static electricity.

Formatting Cards (Initialization)

Format the cards with the camera before use.



- **When a card is formatted, all of the data stored in the card is erased and cannot be restored. Save a backup of necessary data before formatting the card.**



→ [] → Select [Format]



- Do not turn off the camera or perform another operation during formatting.
- Take care not to turn off the camera while formatting is in progress.
- If the card has been formatted with a PC or other device, format it again with the camera.

Attaching a Lens



- Make sure that the camera is turned off.
- Change the lens in a location where there is not a lot of dirt and dust. If dirt or dust gets on the lens, refer to page 475.
- Change the lens while the lens cap is attached.
- When attaching or detaching the interchangeable lens (H-FS12032), retract the lens barrel.

Align the lens fitting marks  on the lens and camera and then rotate the lens in the direction of the arrow.

- Attach the lens by rotating it until it clicks.

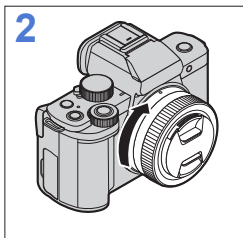
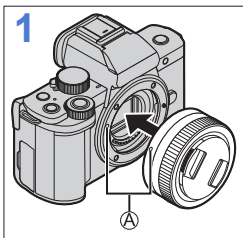

- Insert the lens straight in.
Inserting this at an angle to attach it may damage the camera lens mount.

❖ Removing a Lens

- ① Set the camera on/off switch to [OFF].
- ② While pressing the lens release button **Ⓑ**, rotate the lens in the direction of the arrow until it stops and then remove it.

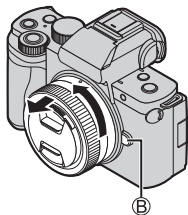

- After removing the lens, be sure to attach the body cap and the lens rear cap.

Extending/retracting the lens <when the interchangeable lens (H-FS12032) is attached>

❖ How to Extend the Lens

Rotate the zoom ring in the direction of arrow ① from position ① (the lens is retracted) to position ② <12 mm to 32 mm> to extend the lens.

- When the lens barrel is retracted, images cannot be recorded.

③ The lens is retracted

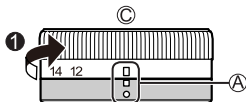

❖ How to Retract the Lens

Rotate the zoom ring in the direction of arrow ② from position ③ <12 mm to 32 mm> to position ④ to retract the lens.

- The zoom ring will seem to click into the 12 mm position, but continue to rotate the lens until it reaches position ④.
- When you are not recording images, we recommend that you retract the lens.

⑤ The lens is extended

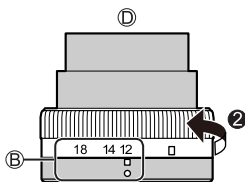

Adjusting the Monitor Direction and Angle

At the time of purchase, the monitor is stowed in the camera body. Turn the monitor surface out before use.

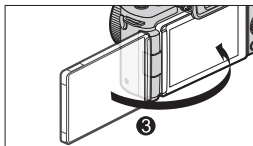
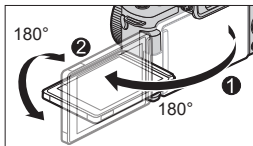

❖ Free angle shooting

You can rotate 180° towards the lens and 90° downwards.

Taking pictures at a low angle

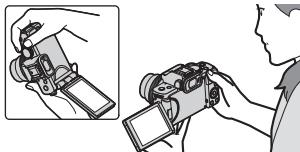

Taking pictures at a high angle

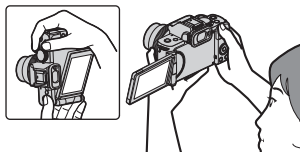

❖ Taking pictures of yourself

If you rotate the monitor as shown in the figure, the camera will switch to Self Shot Mode. (→83)

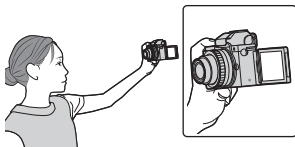

- The angles of adjustment are only guides.
- Do not apply an excessive force to the monitor. This may cause damage or malfunction.
- When not using the camera, close the monitor with the monitor surface facing in.

Setting the Clock (When Turning On for the First Time)

When you turn the camera on for the first time, a screen to set the clock and home area appears.

Be sure to set these settings before use to ensure images are recorded with the correct date and time information.

1 Set the camera on/off switch to [ON].

- If the language select screen is not displayed, proceed to Step 4.

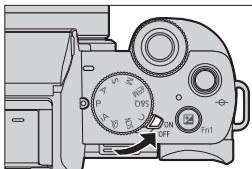

2 When [Please set the language] appears, press **MENU/SET**.

3 Set the language.

- Press ▲▼ to select the language and then press **MENU/SET**.

4 When [Please set the clock] appears, press **MENU/SET**.

5 Set the clock.

◀▶: Select an item (year, month, day, hour or minute).

▲▼: Select a value.

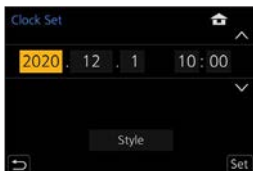

To set the display order (A) and time display format (B).

- Press ▶◀ to select the time zone [Style] and then press **MENU/SET**, the screen for setting the display order and time display format appears.



6 Confirm your selection.

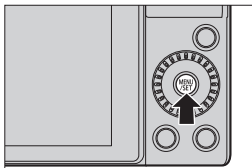

- Press .



7 When [The clock setting has been completed.] appears, press .

8 When [Please set the home area] is displayed, press .

9 Set the home area.

- Press ◀▶ to select your home area and press .
- If you are using Daylight Savings [, press ▲. (The time will move forward by 1 hour.)
To return to the normal time, press ▲ again.

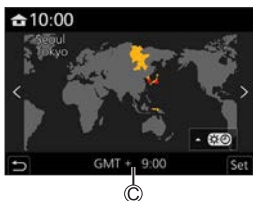

- © Time difference from GMT (Greenwich Mean Time)
- When an interchangeable lens (H-FS12032) is used and the lens barrel is retracted, recording is not possible (a message will be displayed). Rotate the zoom ring to extend the lens. (→43)



- If the camera is used without setting the clock, it will be set to 0:00:00, January 1st, 2020.
- Clock settings are maintained for approx. 3 months using the built-in clock battery even without the battery.
(Leave the fully-charged battery in the camera for approx. 24 hours to charge the built-in battery.)



- [Clock Set] can be changed from the menu:
– [] ⇒ [Clock Set]

3. Basic Operations

Basic Recording Operations

How to Hold the Camera

To minimize camera shake, hold the camera so that it will not move during recording.

Hold the camera with both hands, keep your arms still at your side, and stand with your feet shoulder width apart.

- Hold the camera firmly by wrapping your right hand around the camera grip.
- Support the lens from below with your left hand.
- Do not block the flash, AF Assist Lamp, microphone, or speaker with your fingers or other objects.

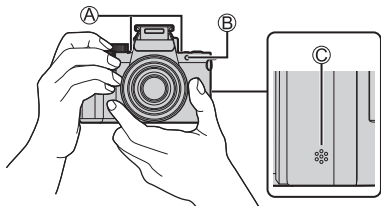

- Ⓐ Microphone
- Ⓑ AF Assist Lamp
- Ⓒ Speaker

❖ Vertical Orientation Detection Function

This function detects when pictures were recorded with the camera held vertically orientated.

With the default settings, pictures are automatically played back vertically orientated. (→ [368](#))



- When the camera is tilted significantly up or down, the vertical orientation detection function may not work correctly.
- Images recorded using the following functions cannot be displayed vertically orientated:
 - Video recording, [4K PHOTO], [Post Focus]

Taking Pictures

1 Adjust the focus.

- Press the shutter button halfway (press it gently).
- The aperture value (A) and shutter speed (B) are displayed. (If the aperture value and shutter speed are shown in red and flashing, you do not have the appropriate exposure, unless you are using the flash.)
- Once the subject is in focus, the focus indication (C) lights. (When the subject is not in focus, the indication blinks.)

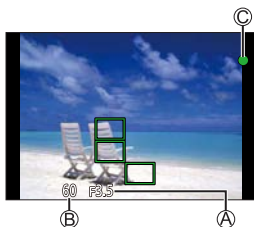
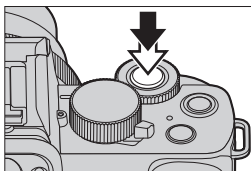

2 Start recording.

- Press the shutter button fully (press it further).

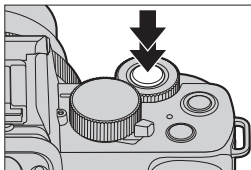



- Recorded pictures can be displayed automatically by setting [Auto Review] of the [Custom] ([Monitor / Display]) menu. You can also change the picture display duration to your preferred setting. (→340)



- With the default settings, you cannot take a picture until the subject is brought into focus.**

If you set [Focus/Release Priority] in the [Custom] ([Focus / Release Shutter]) menu to [BALANCE] or [RELEASE], you will be able to take a picture even when the subject is not in focus. (→334)

Recording Videos

1 Start recording.

- Press the video rec. button.
- Release the video rec. button right after you press it.

2 Stop recording.



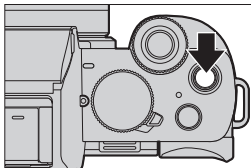

- Press the video rec. button again.

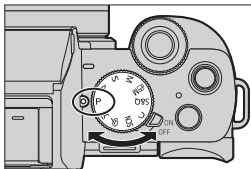

Selecting the Recording Mode

Rotate the mode dial.



iA	 Intelligent Auto mode (→74)
	 Intelligent Auto Plus mode (→77)
P	Program AE mode (→91)
A	Aperture-Priority AE mode (→93)
S	Shutter-Priority AE mode (→96)
M	Manual Exposure mode (→98)
 M	Creative Video mode (→244)
S&Q	Slow & Quick mode (→250)
C	Custom mode (→303)
SCN	Scene Guide mode (→105)
	Creative Control mode (→110)

Camera Setting Operations

When changing the camera settings, operate the camera using the following operation parts.

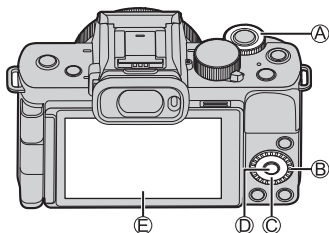

(A)	Front dial (→53)
(B)	Control dial (→53)
(C)	Cursor buttons (→54)
(D)	[MENU/SET] button (→54)
(E)	Touch screen (→54)

❖ Front Dial (☀️)/Control Dial (⚙️)

Rotate:

Selects an item or numeric value.

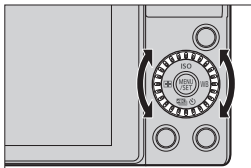
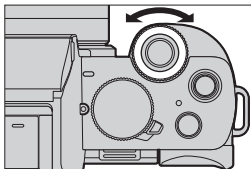

❖ Cursor Buttons (▲▼◀▶)

Press:

Selects an item or numeric value.

❖ [MENU/SET] Button (MENU/SET)

Press:

Confirms a setting.

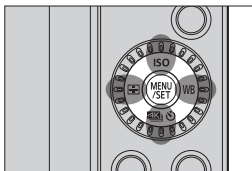

❖ Touch Screen

Operations can be performed by touching the icons, slide bars, menus, and other items displayed on the screen.

Ⓐ Touch

Operation of touching and then lifting your finger from the touch screen.

Ⓑ Drag

Operation of moving a finger while it touches the touch screen.

Ⓒ Pinch (widen/narrow)

Operations of widening the distance between two fingers (pinch out) and narrowing the distance between two fingers (pinch in) while they are touching the touch screen.

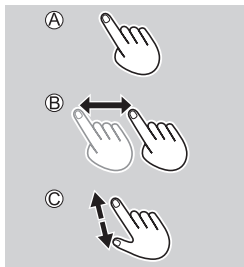

- If you will use a commercially available monitor protection sheet, observe the precautions for the sheet.
(Visibility and operability may be impaired depending on the type of monitor protection sheet.)



- Touch operations can be disabled:
[C] → [☀] → [Touch Settings] (→ 339)

Display Settings

Adjusting the Viewfinder Diopter

Rotate the diopter adjustment dial while looking through the viewfinder.

- Adjust until you can clearly see the text on the viewfinder.

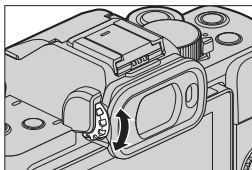

Switching Between the Monitor and Viewfinder

With the default settings, automatic viewfinder/monitor switching is set. When you look through the viewfinder, the eye sensor (A) works and the camera switches from monitor display to viewfinder display.

You can switch to viewfinder display or monitor display with [LVF] (B).

Press [LVF].

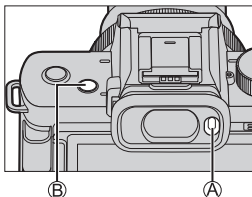

Automatic viewfinder/
monitor switching

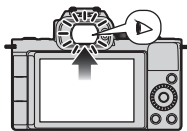

Viewfinder display

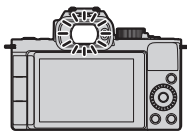

Monitor display

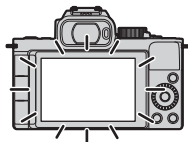





- If [LVF Display Speed] is set to [ECO 30fps] when the viewfinder is used, the camera can be operated for a longer period since battery drainage is reduced.



- In Self Shot Mode, the display automatically switches to monitor display, and the [LVF] and eye sensor are disabled.
- The eye sensor may not work correctly due to the shape of eyeglasses, the way the camera is held, or bright light shining around the eyepiece.
- During video playback or slide show, automatic viewfinder/monitor switching does not work.



- To focus when looking through the viewfinder:
[] ⇒ [] ⇒ [Eye Sensor AF] (→332)
- The sensitivity of the eye sensor can be changed:
[] ⇒ [Eye Sensor] (→356)

Switching the Display Information

You can switch the viewfinder/monitor display method.

Press **[DISP.]**.

- The display information is switched.

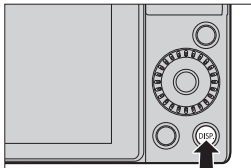

❖ Recording Screen

Monitor

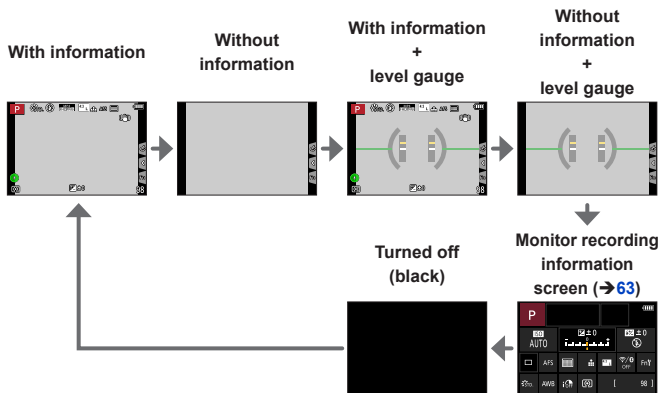

Viewfinder

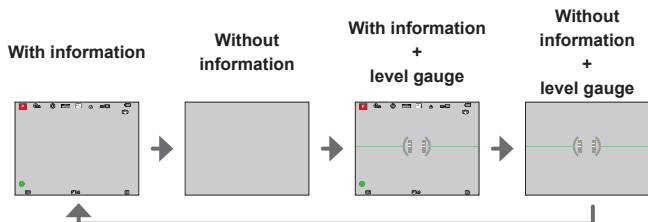

- You can switch the viewfinder/monitor display method:
[C] → [I] → [LVF/Monitor Disp. Set] (→345)

Using the level gauge

The yellow line indicates the current angle. Correct the angle of the camera so that it matches the white line.

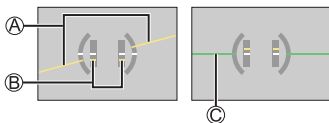

- (A) Horizontal
- (B) Vertical
- (C) Green (no tilt)



- Even after correcting the tilt, there may still be an error of approx. $\pm 1^\circ$.
- When the camera is tilted significantly upwards or downwards, the level gauge may not be displayed correctly.
- You can adjust the level gauge and reset the adjusted values in [Level Gauge Adjust.] in the [Setup] menu. (→359)

❖ Playback Screen

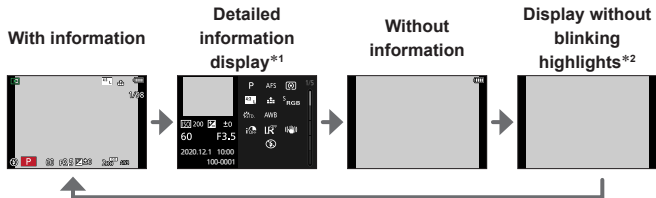

*1 Pressing ▲ ▼ switches the display information. (→459)

*2 This is a screen without blinking highlights display that is shown when [Highlight] of the [Custom] ([Monitor / Display]) is set to [ON].

In other than this screen, overexposed parts of the screen will blink. (→344)

Quick Menu

This menu enables you to quickly set functions that are frequently used during recording without calling up the menu screen. You can also change the Quick menu display method and the items to display.

1 Display the Quick menu.

- Press [Q.MENU].

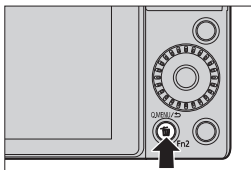

2 Select a menu item.

- Rotate .
- Selection is also possible by touching a menu item.



3 Select a setting item.

- Rotate .
- Selection is also possible by touching a setting item.

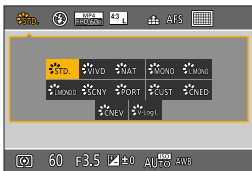

4 Close the Quick menu.

- Press the shutter button halfway.
- You can also close the menu by pressing [Q.MENU].

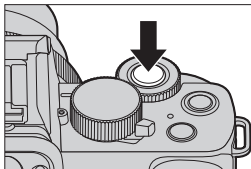



- Some items cannot be set depending on the recording mode or camera settings.



- The Quick menu can be customized:

[] ⇒ [] ⇒ [Q.MENU] ⇒ [CUSTOM] (⇒ [299](#))

Monitor recording information screen

This screen allows you to view the current recording settings on the monitor.

- This screen is displayed only when [Monitor Info. Disp.] in the [Custom] ([Monitor / Display]) menu is set to [ON].

1 Display the monitor recording information screen.

- Press [DISP.] several times.

2 Touch the items.

- The setting screens for each of the items are displayed.

3 Change the setting.

Example) Changing the AF Mode

- Touch the setting item.
- Refer to the pages explaining each item for information on how to change the settings.

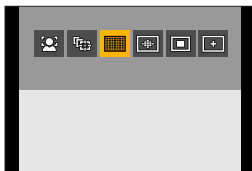
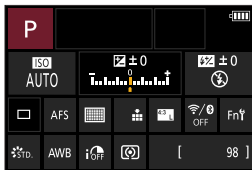

(When [Set] is displayed on the monitor)

4 Touch [Set].

Steps **2** to **4** can also be changed using the following operations.

- 1 Press [Q.MENU].
- 2 Press ▲ ▼ ◀ ▶ (or rotate 🌞) to select an item.
- 3 Rotate ⚙️ to change the settings values.

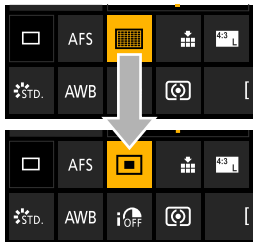

- Some items cannot be set depending on the recording mode or camera settings.

Menu Operation Methods

In this camera, the menu is used for setting a wide variety of functions and performing camera customizations.





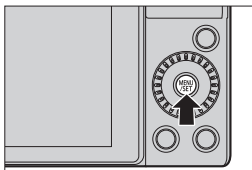

Menu operations can be performed using the cursors, dial, or by touch.

1 Display the menu.

- Press .







2 Switch the menu type.

- 1 Press .
- 2 Press   to select a tab such as .
 - You can also select the tab by rotating  or .
- 3 Press .





3 Select a menu item.

- Press   to select a menu item and then press .
- You can also perform the same operation by rotating  to select the menu item and then pressing .



4 Select a setting item and then confirm your selection.

- Press ▲▼ to select a setting item and then press .
- You can also perform the same operation by rotating  to select the setting item and then pressing .



5 Close the menu.

- Press the shutter button halfway.
- You can also close the menu by pressing  several times.



• For details about menu items, refer to Menu Guide. (→307)

❖ Displaying Descriptions About Menu Items and Settings

If you press [DISP.] while a menu item or setting item is selected, a description about the item is displayed on the screen.



❖ Grayed Out Menu Items

Menu items that cannot be set are displayed grayed out.

In some setting conditions, the reason the setting is disabled is displayed when you press  if you select a grayed-out item.



[Reset]

Return each of the following settings to the default setting:

- Recording settings
- Network settings (settings of [Wi-Fi Setup] and [Bluetooth])
- Custom settings ([Face Recog.] and [Profile Setup] settings)
- Setup/custom settings
(except for [Wi-Fi Setup], [Bluetooth], [Face Recog.] and [Profile Setup] settings)

 ⇒ [] ⇒ Select [Reset]



- When the setup/custom settings are reset, the following settings are also reset:
 - The [World Time] setting
 - The [Travel Date] setting (Departure date, Return date, [Location])
 - The settings of [Rotate Disp.], [Picture Sort] and [Delete Confirmation] in the [Playback] menu
- Folder numbers and clock settings will not be reset.

Recording Using Touch Functions

Touch AF/Touch Shutter



Touch functions allow you to focus on the point that you touch, release the shutter, etc.

1 Touch [].

2 Touch the icon.

- The icon switches each time you touch it.



Touch AF	Focus on the Touched Position.
Touch Shutter	Record with focus on the point touched.
OFF	—

3 (When set to anything other than OFF)
Touch the subject.



- When the Touch Shutter fails, the AF area first turns red and then disappears.



- Refer to “Operations on the AF area movement screen” on page 132 for information about operations to move the AF area.
- It is also possible to optimize the focus and brightness on the touched position:

[] ⇒ [] ⇒ [Touch Settings] ⇒ [Touch AF] ⇒ [AF+AE] (→142)

Touch AE



This function adjusts the brightness according to a touched position. When a subject's face appears dark, you can make the screen brighter to match the face.

1 Touch [].

2 Touch [].

- The Touch AE settings screen appears.

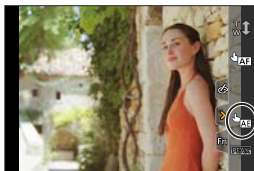

3 Touch the subject to which you wish to adjust the brightness.

- To return the position to which to adjust the brightness to the center, touch [Reset].

4 Touch [Set].



❖ How to Disable Touch AE

Touch [].



- When the following function is being used, Touch AE is not available:
 - Self Shot Mode
 - [Digital Zoom]
 - [4K Live Cropping]



- You can also adjust both the focus and brightness to those of the position you touch. (At this time, Touch AE is not available):
 [] ⇒ [] ⇒ [Touch Settings] ⇒ [Touch AF] ⇒ [AF+AE] (→142)

Recording with the Tripod grip

It can be used as a grip for recording while walking. You can take pictures or record video without operating the camera. It can also be used as a tripod.

- Use the tripod grip supplied with the DC-G100V or the tripod grip (DMW-SHGR1: optional).



- Insert the battery pack and a memory card into the camera before mounting it to the tripod grip.
- Do not use any other tripod grips except the supplied one or a genuine Panasonic tripod grip (DMW-SHGR1: optional).
- After usage, remove the tripod grip from the camera.
- Be careful not to get your finger or any other part of your body caught.
- The carrying capacity (total mass of the loading camera body, lens, battery, and other attached accessories) is 1.2 kg (2.65 lb).
(When the carrying capacity is exceeded, it may cause injuries or damage.)
- Confirm that the tripod grip is securely attached to the camera before using it.
- Do not carry the tripod grip only with the hand strap while the camera is attached.
- Depending on the camera angle or the lens and accessories attached, it may not balance and become unstable. Do not use it as a tripod when the tripod grip is in an unstable state.
- Do not carry it holding only the legs while the tripod's legs are open.

Attaching the Hand Strap

- Ⓐ Hand strap eyelet

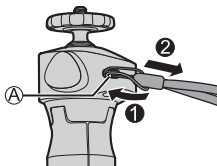

Attaching the camera to a tripod grip

-  • Hold the camera and tripod grip tightly, and securely attach them so that they do not drop.
- For removal, perform the steps backwards.

1 Set the Camera on/off switch to [OFF].

2 Loosen the camera stand.

- Turn the fastening knob in the direction of **(A)**.

- (D)** Camera stand
- (E)** Fastening knob

3 Attach the camera to a tripod grip.

- Align the camera screw with the tripod mount on the camera. Turn the camera stand in the direction of **(B)**, and tighten it firmly.

4 Lock the camera stand.

- Adjust the orientation of the camera. Turn the fastening knob in the direction of **(C)**, and tighten it firmly.
- The camera stand can be tilted 40 degrees in any direction.

5 Connect the camera with the connection cable.

- Connect the connection cable into the camera's [USB/CHARGE] socket.
- Check the direction of the terminals and plug in/out straight holding onto the plug. (Inserting at an angle can deform the terminal and cause malfunction.)

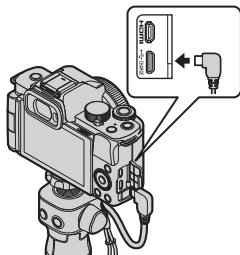
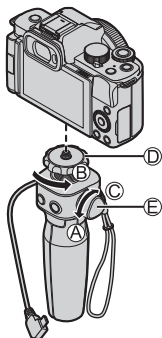

Using as a grip

To prevent dropping, be sure to attach the supplied strap and fit it to your wrist.

1 Close the tripod grip's legs, put your wrist through the hand strap and grip it.

- Slide adjuster (A), and secure the hand strap onto your wrist.
- When adjusting the direction of the camera, hold the camera with your hand and loosen the fastening knob to adjust the direction. After adjusting, securely tighten the fastening knob

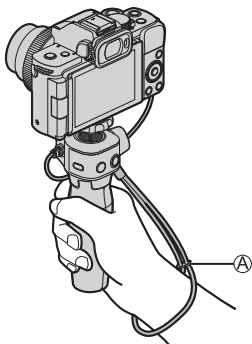

2 Press the button and record.

❖ Self-shooting style

If you attach the camera to the direction shown and rotate the monitor, you can record in Self Shot Mode. (→83)

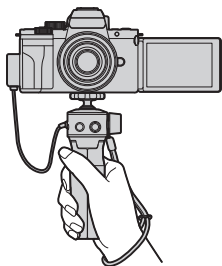

❖ Taking pictures

- 1 Focus on the subject.
 - Press the shutter button (B) halfway (press lightly).
- 2 Take a picture.
 - Press the shutter button fully (push the button all the way).

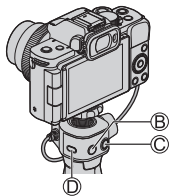

❖ Recording video

- 1 Start recording.
 - Press the video rec. button (C).
 - Immediately release the video rec. button after pressing it.
- 2 End recording.
 - Press the video rec. button again.

❖ Sleep button (D)

Press: The camera will go into a sleep (power save) status.

- This is the same state as [Sleep Mode] under [Economy]. (→37)
- When the camera is under a status where [Sleep Mode] does not work, the camera will not enter sleep status.
- The camera can enter sleep status even when [Sleep Mode] is set to [OFF].
- To wake the camera up from sleep, press the shutter button halfway down.

Using as a tripod

- 1 Open the legs of the tripod grip.
- 2 Place it in a level and stable place.

- When adjusting the direction of the camera, hold the camera with your hand and loosen the fastening knob to adjust the direction. After adjusting, securely tighten the fastening knob.

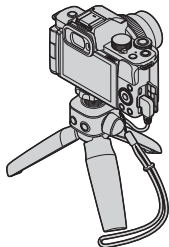

4. Recording mode

For information about the [P/M] mode and [S&Q] mode, refer to pages 244 and 250, and for the [C] mode, refer to page 303.

Intelligent Auto Mode



In the [iA] mode (Intelligent Auto mode), the camera detects the scene to set the optimal recording settings automatically to match the subject and recording conditions.

1 Set the mode dial to [iA].

- In default settings, the mode is set to Intelligent Auto Plus Mode.

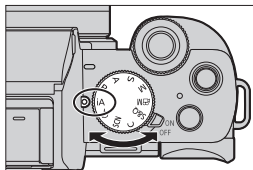

2 Aim the camera at the subject.

- When the camera detects the scene, the recording mode icon changes. (Automatic Scene Detection)



3 Adjust the focus.

- Press the shutter button halfway.
- Once the subject is in focus, the focus indication lights. (When the subject is not in focus, the indication blinks.)

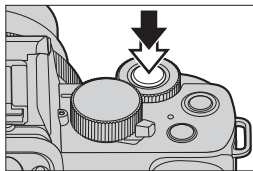

4 Start recording.

- Press the shutter button fully.

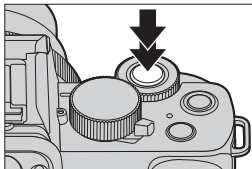

- Backlight compensation operates automatically to prevent subjects from appearing dark when there is a backlight.

❖ Types of Automatic Scene Detection

 : Scenes detected during picture taking

 : Scenes detected during video recording



[i-Portrait]



[i-Scenery]



[i-Macro]



[i-Night Portrait]*1



[i-Night Scenery]



[i-Handheld Night Shot]*2



[i-Food]



[i-Baby]*3



[i-Sunset]



[i-Low Light]







[iA]/[iA+]

*1 Displayed only when using flash.

*2 Displayed only when [iHandheld Night Shot] is [ON].

*3 Displayed when children (that are registered in the camera with Face Recognition) under 3 years old are recognized.





- If none of the scenes are applicable, it is recorded with /[] (standard setting).
- When [Face Recog.] is set to [ON] and if the camera recognizes a face similar to a registered face, [R] is displayed on the upper right corner of the , , and  icons.
- Different scene types may be selected for the same subject depending on the recording conditions.

❖ Intelligent Auto Plus Mode

[iA⁺] allows you to adjust some settings such as the brightness and color tone while also using [iA] for other settings so that you can record pictures more suited to your preferences.

(✓: Available, -: Not available)

	 Intelligent Auto Plus Mode	 Intelligent Auto Mode
Setting the color tone	✓	-
Setting the brightness (exposure)	✓	-
Defocus control function	✓	-
Menus that can be set	Many	Few

 → []/[] → Select [Intelligent Auto Mode]

Settings: [] (Intelligent Auto Mode)/

[] (Intelligent Auto Plus Mode)



- It is also possible to display the selection screen by touching the recording mode icon in recording screen.



❖ [AF Mode]

[AF Mode] is automatically set to [Face/Eye Detection].

- If you touch the subject, the camera switches to [Tracking] and the AF tracking function starts operating.
 - The AF tracking function will also work if you press [AF-ON] (◀) and then press the shutter button halfway.
- Each press of [AF Mode] (◀) changes the AF mode.



• For information about AF modes, refer to page 131 and 133.

❖ Flash

When recording using a flash, the camera switches to the appropriate flash mode for the recording conditions.



- When [Red-Eye Removal] or [Red-Eye Reduction], Red-Eye Removal works.
- When Slow Sync. ([Red-Eye Reduction], [Red-Eye Reduction]), be careful with regard to camera shake because the shutter speed becomes slow.
- In Intelligent Auto Plus Mode, you can set [Flash Mode] under [Flash] in the [Rec] menu to [Forced Flash Off] even when the flash is open.

[Intelligent Auto] menu



❖ [iHandheld Night Shot]

If a night scene is detected automatically while the unit is being handheld, [iHandheld Night Shot] can record a still picture with less jitter and less noise without using a tripod by combining a burst of pictures.

→ / → Select [iHandheld Night Shot]

Settings: [ON]/[OFF]

- The flash is fixed to the (Forced Flash Off) setting.

❖ [iHDR]

When there is, for example, a strong contrast between the background and the subject, [iHDR] records multiple still pictures with differing exposures and combines them to create a single still picture rich in gradation.

→ / → Select [iHDR]

Settings: [ON]/[OFF]

- [iHDR] is activated when required. When activated, [HDR] will be displayed on the screen.
- Since a burst of still pictures are combined after they have been recorded, it will be a few moments before you can record another picture.
- In the case of composition from a burst, afterimages may appear if the subject was moving.



- The angle of view becomes slightly narrow.
- After the shutter button has been pressed, do not move the camera during the burst operation.
- This function will not work for still pictures while video is being recorded.
- [iHDR] and [iHandheld Night Shot] are not available when using the following functions:
 - Self Shot Mode
 - [Burst]
 - [4K PHOTO], [Post Focus]
 - [Bracket]
 - [RAW], [RAW], [RAW] ([Quality])
 - [Ex. Tele Conv.] ([Rec])
 - [Time Lapse Shot]
 - [Stop Motion Animation] (when [Auto Shooting] is set)
- [iHDR] does not work when firing the flash.

Taking pictures with different color tones, degrees of blurriness, and brightness



❖ Setting coloring

- 1 Press [WB] (▶) to display the setting screen.
- 2 Rotate or to adjust color.
 - Press the shutter button halfway to return to the recording screen.
 - The color setting will return to the default level (center point) when this unit is turned off or the camera is switched to another Recording mode.



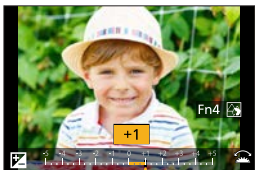

❖ Setting brightness

- 1 Press [].
- 2 Rotate or to adjust brightness.
 - Press the shutter button halfway to return to the recording screen.





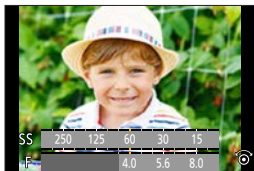

❖ Defocusing the background (Defocus control function)

- 1 Press [Z], and then press [Fn4].
- 2 Rotate  or  to adjust the background defocusing condition.
 - Press the shutter button halfway to return to the recording screen.
 - AF Mode is set to [].
The position of the AF area can be set by touching the screen. (Its size cannot be changed)







❖ With touch screen operations

- 1 Touch [].
- 2 Touch the item you want to set.
 - []: Coloring
 - []: Degree of defocusing
 - []: Brightness
- 3 Drag the slide bar or exposure meter to set.
 - Press the shutter button halfway to return to the recording screen.



-  Depending on the lens used, you may hear a sound from the lens while operating Defocus Control. This is due to the aperture operation of the lens and is not a malfunction.
- Depending on the lens used, operational sound of the Defocus Control may be recorded during the recording of a video when the function is used.

-  At the brightness setting screen you can assign the exposure bracket to  :
[] → [] → [Exposure Comp. Disp. Setting] (→337)

Self Shot Mode ([Self Shot])



You can easily take pictures of yourself while looking at the screen.

1 Rotate the monitor as shown in the figure.

- A mirror image will be displayed on the monitor.
- The touch operation is enabled.
- [Quick AF] is set to [ON]. (→332)

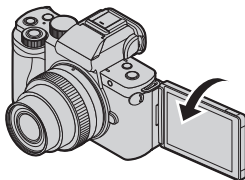

2 Touch the item.

- For details, refer to page 84.
- Ⓐ 4K Selfie (→87)
- Ⓑ Built-in microphone setting ([Self Shot]) (→86)

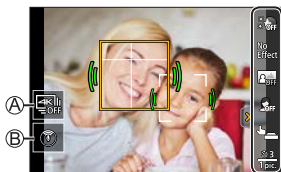

3 Touch [Exit].

4 Decide on your poses while looking at the monitor.

- The AF area is displayed around the subject's face by the Face/Eye Detection function.
- The camera will automatically display a mark indicating the sound pickup target around the AF area depending on the state of the subject. (→266)
- If [Self Shot] in AF Mode is not available with the current Recording Mode, an available focus setting for each Recording Mode will be used.

5 Take the picture.



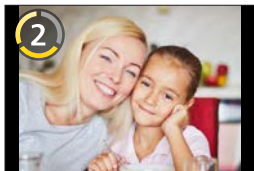



- For information on how to start taking a picture, refer to [Shutter] (→85)
- Regardless of the [Shutter] setting, you can start recording by pressing the shutter button or video rec. button.







- With the default setting, it will focus automatically after the countdown ends. ([AF After Countdown] (→348))

❖ Setting items

▶ : Default settings



 [Soft Skin]	▶ OFF/1 to 10 Makes people's faces look brighter and their skin tones look softer.
No Effect [Filter Select]	▶  (No effect), [EXPS] (Expressive), [RETR] (Retro), [HKEY] (High key), [MONO] (Monochrome), [TOY] (Toy effect) Add a filter effect appropriate to [Self Shot].
 [Background Control]	▶  (Off),  (Defocus),  (Clear) Changes the degree of defocusing for the background of detected faces.
 [Slimming Mode]	▶ OFF/1 to 10 Makes people look slimmer.

 [Shutter]

 (Shutter button only),  (Touch),
 (Buddy),  (Face)

Sets the way the shutter is released.

 (**Shutter button only**): Push the shutter button to take pictures or the video rec. button to record video.

 (**Touch**): Focuses on the touched position before taking a picture. (Records a video when in /[S&Q] mode.)

 (**Buddy**): The shutter is released when two faces detected move closer to each other.

- Even if several subjects are present, Face/Eye Detection detects only a maximum of two faces.

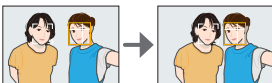





 (**Face**): The shutter is released when a face is covered with a hand or other object and then detected again.

 [Countdown]/
 1pic. [Shots]

OFF/1 to 10 ( 3)

Set the number of seconds before recording ([Countdown]).

 (1 pic.),  (2 pic.),  (3 pic.),
 (4 pic.)

Set the number of consecutive shots ([Shots]).

❖ Recording self-shot videos with automatically adjusted settings

The camera records people well-lit and with clear backgrounds by automatically focusing on them. This is good for recording self-shot videos to upload to social media.

Set the mode dial to one of the following.

- [P] mode, [A] mode, [S] mode, [M] mode
- [M] mode (Set [Exposure Mode] to [P])
- [S&Q] mode (Set [S&Q Exposure Mode] to [P])



- You can record videos in recording modes other than the above, but it will not be set as self-shot videos with automatically adjusted settings.

Built-in microphone setting ([Self Shot])



You can set the sound pickup range when using the built-in microphone by touching an icon on the screen.

1 Touch [🔊].



2 Select and touch the sound pickup range.

Settings: [AUTO]/[SURROUND]/
[FRONT]/[TRACKING]/
[BACK]

- For details, refer to page 265.

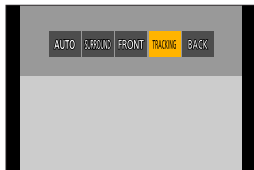

- This does not work with [Built-in Mic] of the video menu.

4K Selfie



You can switch to 4K Photo Mode and take pictures of yourself.

1 Touch [Self Shot Off].



2 Select and touch the recording method.

- In Self Shot Mode, you can take pictures with [4K Burst (Wide-angle)], a setting that allows you to include a wider background.
(In modes other than Self Shot Mode, the setting will switch to [4K Burst].)

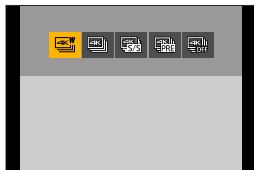

 [4K Burst (Wide-angle)]	A 4K Photo Mode for taking selfies with an angle of view wider than that of [4K Burst] Burst speed: 15 pictures/second Audio recording: Not available
---	--

- For information about other types of 4K Photo Mode and the recording methods for 4K Photo Mode, etc., refer to (→164)

3 Decide on your poses while looking at the monitor.

(When [4K Burst (Wide-angle)] is selected)

- 1 Press the shutter button halfway.
- 2 Press and hold the shutter button fully for as long as you want to perform recording.



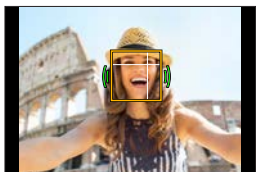
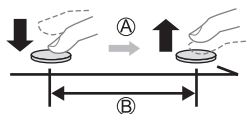

- (A) Press and hold
 (B) Recording is performed

- Recording will start approximately 0.5 seconds after you press the shutter button fully. Therefore, press the button fully slightly in advance.
- [Continuous AF] does not work during recording. The focus is fixed in the first picture.
- If you stop recording burst pictures too soon, the camera may continue recording until a certain time.



- When recording 4K photos, the angle of view becomes narrower. (Except when recording with [4K Burst (Wide-angle)])
- For 4K photo recording, only [Filter Select] can be set.



- If you set [Self Shot] to [OFF], the mode will not switch to Self Shot Mode even if you rotate the monitor. (→348)
- Be careful not to look at the light from the flash and the AF Assist Lamp directly.
- When the [Soft Skin] is set
 - If you set the strength of the effect to [2] or greater, the recording screen display will be more delayed than normal like a frame dropping. Also, when you record, it will require some time to process the image before the next shot.
 - The smoothing effect is applied to the part that has a similar tone to the complexion of a subject, as well.
 - This mode may not be effective under insufficient lighting.
- When [Background Control] is set to  (Defocus), the recording screen display will be more delayed than normal like a frame dropping. Also, when you record, it will require some time to process the image before the next shot.
- If the lighting is insufficient when [Background Control] is set to  (Clear), you may not be able to take pictures as desired.
- When the following functions are being used, Self Shot Mode is not available:
 - [Time Lapse Shot]
 - [Stop Motion Animation]
 - [Multi Exp.]
 - [Live View Composite]
- [Soft Skin] and a  (Defocus) setting of [Background Control] are not available when using the following functions:
 - Video recording
 - [Glistening Water], [Clear Nightscape], [Cool Night Sky], [Warm Glowing Nightscape], [Artistic Nightscape], [Glittering Illuminations], [Handheld Night Shot], [Soft Image of a Flower], [Appetizing Food], [Cute Dessert] ([SCN] mode)
 -  mode
 - Manual Focus



- When the following functions are being used, a [Background Control] setting of [Clear] is not available:
 - Video recording
 - Any mode for [SCN] mode other than [Silky Skin]/[Monochrome]
 - [A] mode, [S] mode, [M] mode, [S&Q] mode
- When [Filter Settings] in the [Rec] / [Motion Picture] menu is not available, [Filter Select] in the Self Shot Mode is also unavailable.
- When recording video, [Slimming Mode] and [Shots] cannot be used.
- [Buddy] and [Face] are not available when using the following functions:
 - [M] mode, [S&Q] mode
 - Recording Modes which do not allow setting to [AF Mode] of AF Mode (→ 130)
 - Manual Focus

Program AE Mode



In [P] mode (Program AE mode), the camera automatically sets the shutter speed and aperture value for the brightness of the subject. You can also use Program Shift to change combinations of shutter speed and aperture values while keeping the same exposure.

1 Set the mode dial to [P].

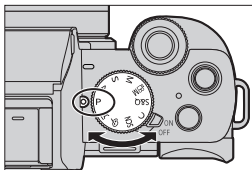

2 Press the shutter button halfway.

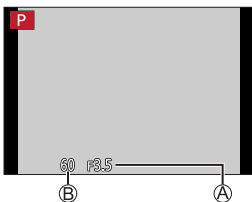
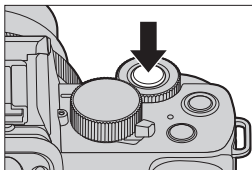

- This displays the aperture value (A) and shutter speed value (B) on the recording screen.
- If the correct exposure is not achieved, the aperture value and shutter speed blink red.



3 Start recording.



❖ Program Shift

You can change the shutter speed and aperture value combination set automatically by the camera while maintaining the same exposure. With this, you can, for example, make the background more defocused by decreasing the aperture value or capture a moving subject more dynamically by slowing the shutter speed.

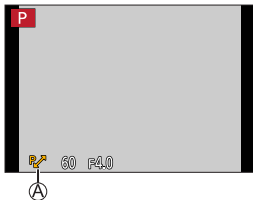
- 1 Press the shutter button halfway.
 - This displays the aperture value and shutter speed value on the recording screen. (Approx. 10 seconds)
- 2 Rotate  or  while the values are displayed.
 - This displays the Program Shift icon  on the recording screen.
- 3 Start recording.







Canceling Program Shift

- Set the camera on/off switch to [OFF].
- Rotate  or  until the Program Shift icon disappears.



- Program Shift is not available when using the following functions:
 - Flash
 - [4K PHOTO], [Post Focus]
 - [ISO] (ISO sensitivity)



- You can customize dial operations:
 - [] ⇒ [] ⇒ [Dial Set.] ⇒ [Rotation (F/SS)] (→338)
 - The recording screen can display an exposure meter indicating the relationship between aperture value and shutter speed:
 - [] ⇒ [] ⇒ [Expo.Meter] (→345)

Aperture-Priority AE Mode



In [A] mode (Aperture-Priority AE mode), you can set the aperture value before recording.

The shutter speed will be automatically set by the camera.



Smaller aperture values

It becomes easier to defocus the background.



Larger aperture values

It becomes easier to bring everything into focus including the background.

1 Set the mode dial to [A].

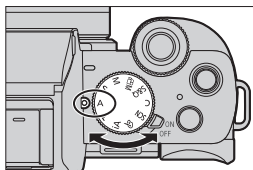

2 Set the aperture value.

- Rotate  or .

3 Start recording.

- If the correct exposure is not achieved when the shutter button is pressed halfway, the aperture value and the shutter speed blink red.

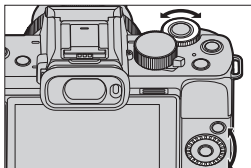

❖ Depth of Field Characteristics

Aperture value	Small	Large
Focal length of lens	Telephoto	Wide-angle
Distance to subject	Near	More distant
Depth of field (area in sharp focus)	Shallow (narrow) Example: When you want to take an image with a defocused background.	Deep (wide) Example: When you want to take an image with focus as far as the background.



- The effects of the set aperture value and shutter speed will not be visible on the recording screen.

To check the effects on the recording screen, use [Preview]. (→104)

- The brightness of the recording screen and of actual recorded images may differ.

Check the images on the playback screen.

- When using a lens with an aperture ring, set the position of the aperture ring to other than [A] to use the aperture value of the lens.



- You can customize dial operations:

[] → [] → [Dial Set.] → [Assign Dial (F/SS)]/[Rotation (F/SS)] (→338)

- The recording screen can display an exposure meter indicating the relationship between aperture value and shutter speed:

[] → [] → [Expo.Meter] (→345)

Shutter-Priority AE Mode



In [S] mode (Shutter-Priority AE mode), you can set the shutter speed before recording.

The aperture value will be automatically set by the camera.



Slower shutter speeds

It becomes easier to capture motion



Faster shutter speeds

It becomes easier to freeze motion

1 Set the mode dial to [S].

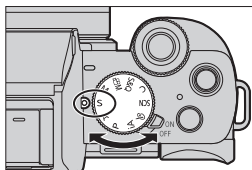

2 Set the shutter speed.

- Rotate  or .

3 Start recording.

- If the correct exposure is not achieved when the shutter button is pressed halfway, the aperture value and the shutter speed blink red.

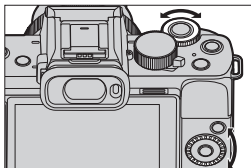

- The effects of the set aperture value and shutter speed will not be visible on the recording screen.

To check the effects on the recording screen, use [Preview]. (→104)

- The brightness of the recording screen and of actual recorded images may differ.

Check the images on the playback screen.

- Shutter speeds faster than 1/50 of a second are not available when you fire the flash. (→230)



- You can customize dial operations:

[] ⇒ [] ⇒ [Dial Set.] ⇒ [Assign Dial (F/SS)]/[Rotation (F/SS)] (→338)

- The recording screen can display an exposure meter indicating the relationship between aperture value and shutter speed:

[] ⇒ [] ⇒ [Expo.Meter] (→345)

Manual Exposure Mode



In [M] mode (Manual Exposure mode), you can take pictures by manually setting the aperture value and shutter speed.

In default settings, the ISO sensitivity is set to [AUTO].

As a result, the ISO sensitivity will be adjusted according to the aperture value and shutter speed.

Exposure compensation can also be used when ISO sensitivity is set to [AUTO].

1 Set the mode dial to [M].

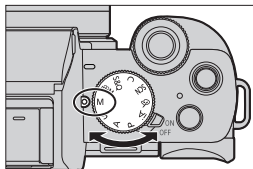

2 Set the aperture value and shutter speed.

- Rotate to set the aperture value, and to set the shutter speed.

- (A) Aperture value
- (B) Shutter speed

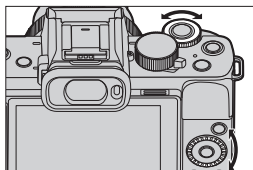

3 Start recording.

- If the correct exposure is not achieved when the shutter button is pressed halfway, the aperture value and the shutter speed blink red.

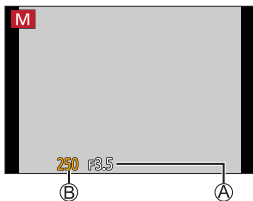

❖ Available Shutter Speeds (Sec.)

[EFC]	[T] (Time, max. approx. 60 seconds), 60 to 1/500
[ESHTR]	1 to 1/16000



- The effects of the set aperture value and shutter speed will not be visible on the recording screen.

To check the effects on the recording screen, use [Preview]. (→104)

You can set the preview mode to operate constantly in [M] mode.

[C/F] → [I] → [Constant Preview] (→341)

- The brightness of the recording screen and of actual recorded images may differ.

Check the images on the playback screen.

- When using a lens with an aperture ring, set the position of the aperture ring to other than [A] to use the aperture value of the lens.
- Shutter speeds faster than 1/50 of a second are not available when you fire the flash. (→230)



- You can customize dial operations:

[C/F] → [A] → [Dial Set.] → [Assign Dial (F/SS)]/[Rotation (F/SS)] (→338)

- The recording screen can display an exposure meter indicating the relationship between aperture value and shutter speed:

[C/F] → [I] → [Expo.Meter] (→345)

❖ Manual Exposure Assist

When ISO sensitivity is set to other than [AUTO], Manual Exposure Assist (Example: ) will be displayed on the recording screen.

You can check the difference between the current exposure value and the correct exposure (± 0) measured by the camera.

- Use Manual Exposure Assist as a guide.

We recommend checking the images on the playback screen when recording.

❖ [T] (Time)

If you set the shutter speed to [T], the shutter stays open when the shutter button is pressed fully. (up to approx. 60 seconds)

The shutter closes if you press the shutter button again.

Use this when you want to keep the shutter open for a long time to record images of fireworks, night scenery or a starry sky.



- We recommend using a tripod or the shutter remote control function (→389) during time recording.

- Time recording may create noticeable noise.

If you are concerned about noise, we recommend that you set [Long Shtr NR] (→320) to [ON] in the [Rec] menu before recording.



- Time is not available when using the following functions:

- When recording using the flash (When [Flash Synchro] is set to [2ND])

- [4K PHOTO], [Post Focus]

- [Time Lapse Shot]

- [Stop Motion Animation] (when [Auto Shooting] is set)

- [Bracket]

- [HDR]

- [Silent Mode]

- Electronic shutter

Live View Composite Recording



The camera records images at set exposure time intervals, and combines parts with changes in bright light to save the result as one picture.

- You can check a combined image at each exposure time interval.
- This function is useful for capturing the light trails of stars and fireworks with bright night scenery in the background.

- Use a tripod to minimize camera shake.

1 Set the mode dial to [M].

2 Start Live View Composite Recording.

- Press **MENU/SET** → [CAMERA] → [Live View Composite] → [Start]



3 Set the exposure time per frame (shutter speed) and ISO sensitivity.

- Rotate **DISK** to set the shutter speed. (1/2 second to 60 seconds)
- Press **▲** and rotate **DISK** to set the ISO sensitivity.

4 Obtain an image with reduced noise.

- Press the shutter button fully.
- A countdown screen is displayed. Wait until this step completes.

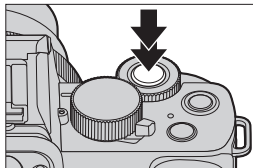

5 Start recording.

- Press the shutter button fully.
- Images are combined every time the exposure time set in step **3** has passed.

(A) Histogram display.

(B) Exposure time per frame × Number of pictures combined.

(C) Elapsed time.

- The time is updated with each increase in the number of pictures combined.

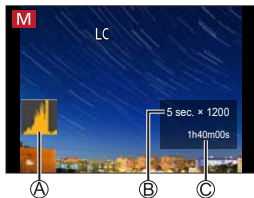

6 Stop recording.

- Press the shutter button fully again.
- This will run noise reduction and save the image.
- Live View Composite can record up to 3 hours per recording.
(Recording stops automatically when the recording time exceeds 3 hours.)

❖ [Shutter Delay]

If you want to reduce the jitter that occurs at the start of recording due to pressing the shutter button, you can set [Shutter Delay] in Step **2**. The shutter will be released when the set time elapses after you press the shutter button.

Settings: [8SEC]/[4SEC]/[2SEC]/[1SEC]/[OFF]

❖ How to cancel Live View Composite Recording

On the recording screen, press [Fn2].



- [Long Shtr NR] is fixed to [ON].
- The flash will only fire on the first frame.
- After an image for noise reduction is obtained, some menus are not displayed.
- The image for noise reduction will be discarded if the following operations are performed. Follow step **4** again.
 - Select [Start] with [Live View Composite].
 - Changing the shutter speed
 - Changing the ISO sensitivity
 - Switching to Playback Mode
- When the shutter button is pressed fully to stop recording, the last image will not be included in the combined image.
- When the following functions are being used, [Live View Composite] is not available:
 - Self Shot Mode
 - [Filter Settings]
 - [Silent Mode]
 - [Time Lapse Shot]
 - [Stop Motion Animation]
 - [HDR]
 - [Multi Exp.]
 - Electronic shutter

Preview Mode



You can check the effects of aperture on the recording screen by physically closing the aperture blades of the lens to the aperture value set for actual recording.

In addition to the effects of aperture, you can check the effects of shutter speed at the same time.

- Use the Fn button registered with [Preview] to operate. In default settings, this is registered in the [Fn6].

For information about the Fn button, refer to page [292](#).

Press [Fn6].

- Each press of the button switches between the effect preview screens.

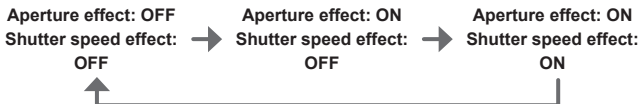
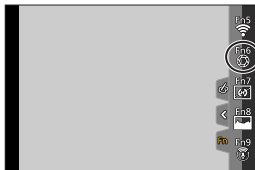

- It is possible to record in preview mode.
- Range for shutter speed effect check is 8 seconds to 1/16000 of a second.
- Preview mode is not available when recording with [4K Pre-Burst].



Scene Guide Mode



If you select a scene to suit the subject and recording conditions with reference to the example images, the camera will set optimal exposure, color, and focus, allowing you to record in a manner appropriate to the scene.

1 Set mode dial to [SCN].

2 Select the scene.

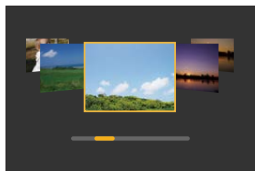

- Press ◀▶ to select the scene and press .
- Selection is also possible by rotating  or .
- The scene can also be selected by touching an example image.
- Press [DISP.] to switch the screen in the order of normal display, guide display, and list display. The guide display shows the description of each scene.





- It is also possible to display the selection screen by touching the recording mode icon in recording screen.



- Depending on the scene, the recording screen may seem as if frames are missed.
- To change the scene, select [Scene Switch] in the [Scene Guide] menu, and then press . You can return to step **2**.
- Some of the recording menu items cannot be set because the camera automatically adjusts the settings to the optimal values.
- Although White Balance is fixed to [AWB] for certain types of scenes, you can fine tune the White Balance or use White Balance bracketing by pressing [WB] () on the recording screen.

Types of Scene Guide Mode





1: [Clear Portrait]

Setting [Soft Skin] and [Slimming Mode]

You can apply the same [Soft Skin] and [Slimming Mode] settings as those specified for Self Shot Mode.

- ① Touch  and select the setting item.

 [Soft Skin]	Makes people's faces look brighter and their skin tones look softer.
 [Slimming Mode]	Makes people look slimmer.



- ② Touch the slide bar.
- You can set it to "Off" or a value in the range [1] to [10]. If you select the left edge of the slide bar , it will be set to "Off".



- ③ Touch [Exit]
- If you change AF Mode to a setting other than  (Face/Eye Detection), [Soft Skin] and [Slimming Mode] will become unavailable.



2: [Silky Skin]

- If a part of the background etc. is a color close to skin color, this part is also smoothed.
- This mode may not be effective when there is insufficient brightness.



3: [Backlit Softness]



4: [Relaxing Tone]



5: [Sweet Child's Face]

- When you touch the face, a still picture is recorded with the focus and exposure set for the touched location



6: [Distinct Scenery]



7: [Bright Blue Sky]



8: [Romantic Sunset Glow]



9: [Vivid Sunset Glow]



10: [Glistening Water]

- Star filter used in this mode may cause glistening effects on the objects other than water surface.



11: [Clear Nightscape]



12: [Cool Night Sky]



13: [Warm Glowing Nightscape]



14: [Artistic Nightscape]



15: [Glittering Illuminations]



16: [Handheld Night Shot]

- After the shutter button has been pressed, do not move the camera during the burst operation.
- The angle of view becomes narrow slightly.



18: [Soft Image of a Flower]

- For close-up recording, we recommend that you avoid using the flash.



20: [Cute Dessert]

- For close-up recording, we recommend that you avoid using the flash.



22: [Clear Sports Shot]



17: [Clear Night Portrait]

- Tripod, self-timer recommended.
- When [Clear Night Portrait] is selected, keep the subject still for about 1 second after taking the picture.



19: [Appetizing Food]

- For close-up recording, we recommend that you avoid using the flash.



21: [Freeze Animal Motion]

- Default [AF Assist Lamp] setting is [OFF].



23: [Monochrome]

Creative Control Mode



You can select the effects to be applied from sample pictures and preview these effects on the screen.

1 Set mode dial to [📷].

2 Select the filter effect.

- Press ▲▼ to select the filter effect and press **MENU/SET**.
- Selection is also possible by rotating or .
- The filter effect can also be selected by touching an example image.

Ⓐ Preview display

- Press [DISP.] to switch the screen in the order of normal display, guide display, and list display. The guide display shows the description of each filter.

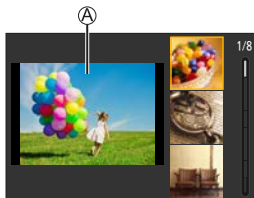

- It is also possible to display the selection screen by touching the recording mode icon in recording screen.



- Depending on the filter effect, the recording screen may seem as if frames are missed.
- [White Balance] will be fixed to [AWB] and ISO sensitivity to [AUTO].

❖ Creative Control Menu

 → Select []

[Filter Effect]	Allows you to display the selection screen of filter effect.
[Simultaneous Record w/o Filter]	Allows you to set the camera to take a picture with and without a filter effect simultaneously.

Types and adjustments of filter effects



1 On the recording screen, press [WB] (▶).

2 Rotate  or  to set.

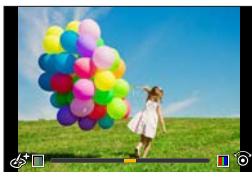





- Press the shutter button halfway to return to the recording screen.
- When the filter effect is adjusted, the filter icon on the recording screen is indicated with [+].



4. Recording mode

Picture effect	Items that can be set
[Expressive]	Vividness
[Retro]	Coloring
[Old Days]	Contrast
[High Key]	Coloring
[Low Key]	Coloring
[Sepia]	Contrast
[Monochrome]	Coloring
[Dynamic Monochrome]	Contrast
[Rough Monochrome]	Grainy picture effect
[Silky Monochrome]	Degree of defocusing
[Impressive Art]	Vividness
[High Dynamic]	Vividness
[Cross Process]	Coloring
[Toy Effect]	Coloring
[Toy Pop]	Range in which peripheral brightness is reduced
[Bleach Bypass]	Contrast
[Miniature Effect]	Vividness
[Soft Focus]	Degree of defocusing
[Fantasy]	Vividness
[Star Filter]	 Rays of light is short/Rays of light is long
	 Smaller/Larger
	 Rotate to the left/Rotate to the right
[One Point Color]	Amount of color retained
[Sunshine]	Coloring





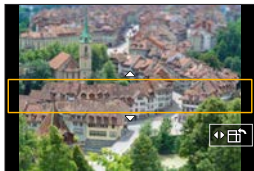

❖ Setting the Type of Defocus ([Miniature Effect])

- ① Set Filter effect to [Miniature Effect].
- ② Touch , and then .
- ③ Press ▲▼ or ◀▶ to move the in-focus portion.
 - You can also move the in-focus portion by touching the screen.
 - You can also switch the defocus orientation by touching .
- ④ Rotate  or  to change the size of in-focus portion.
 - The portion can also be enlarged/reduced by pinching out/pinching in the screen.
 - To reset the in-focus portion setting to the default, press [DISP.].
- ⑤ Press  to set.



- No audio is recorded in videos.
- The length of the video recorded will be approx. 1/10 of the actual recording time. The displayed video recording time will be approx. 10 times longer than the recording time displayed during normal video recording.
- If you end video recording after a short time, the camera may go on recording for a certain period.









❖ Setting the Color to Be Left ([One Point Color])

- 1 Set Filter effect to [One Point Color].
- 2 Touch , and then .
- 3 Press     to move the frame and select the color you want to leave.
 - You can also select the color you want to leave by touching the screen.
 - To return the frame back to the center, press [DISP.].



- 4 Press  to set.

❖ Setting the Light Source Position and Size ([Sunshine])

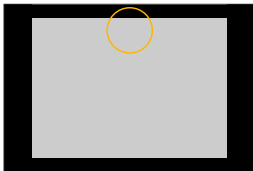

- 1 Set Filter effect to [Sunshine].
- 2 Touch , and then .
- 3 Press     to move the center position of the light source.
 - The position of the light source can also be moved by touching the screen.
- 4 Rotate  or  to adjust the size of the light source.



- This can also be enlarged/reduced by pinching out/pinching in the screen.
 - To reset the light source setting to the default, press [DISP.].
- 5 Press .



Taking pictures with different degrees of blurriness and brightness

❖ Brightness

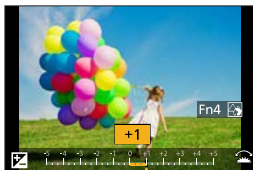
- 1 Press [F4].
- 2 Rotate  or  to adjust brightness.
 - Press the shutter button halfway to return to the recording screen.



❖ Defocusing the background (Defocus control function)

- 1 Press [F4], and then [Fn4].
- 2 Rotate  or  to adjust the background defocusing condition.
 - Press the shutter button halfway to return to the recording screen.

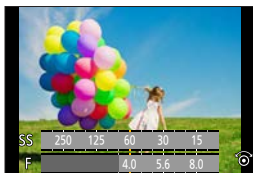

❖ With touch screen operations

- 1 Touch [🔗].
- 2 Touch the item you want to set.
 - [🔍]: Adjusting the filter effect
 - [👁️]: Degree of defocusing
 - [☀️]: Brightness
- 3 Drag the slide bar or exposure meter to set.
 - Press the shutter button halfway to return to the recording screen.



- Defocus control operation is not available in [Miniature Effect] ([🔗] mode).
- At the brightness setting screen you can assign the exposure bracket to
▲▼:
[🔧] → [☀️] → [Exposure Comp. Disp. Setting] (→337)

5. Image Recording

[Aspect Ratio]



You can select the image aspect ratio.

→ → Select [Aspect Ratio]

[4:3]	Aspect ratio of a 4:3 monitor
[3:2]	Aspect ratio of a standard film camera
[16:9]	Aspect ratio of a 16:9 TV
[1:1]	Square aspect ratio



- When the following function is being used, [Aspect Ratio] is not available:
 - [Multi Exp.]

[Picture Size]



Sets the picture's image size.

MENU SET → [CAMERA] → Select [Picture Size]

[Aspect Ratio]	4:3	3:2	16:9	1:1
[Picture Size]	[L] 20M 5184×3888	[L] 17M 5184×3456	[L] 14.5M 5184×2920	[L] 14.5M 3888×3888
	[M] 10M 3712×2784	[M] 9M 3712×2480	[M] 8M 3840×2160	[M] 7.5M 2784×2784
	[S] 5M 2624×1968	[S] 4.5M 2624×1752	[S] 2M 1920×1080	[S] 3.5M 1968×1968

- When [Ex. Tele Conv.] ([Rec]) is set, the [M] and [S] picture sizes are indicated with **[EX]**.



- When the following functions are being used, [Picture Size] is not available:
 - [4K PHOTO], [Post Focus]
 - [RAW] ([Quality])
 - [Multi Exp.]

[Quality]



Set the compression rate used for storing pictures.

→ → Select [Quality]

Setting	File format	Settings details
	JPEG	JPEG images that give priority to image quality.
		JPEG images of standard image quality. This is useful for increasing the number of recordable pictures without changing the picture size.
RAW	RAW+JPEG	This records RAW and JPEG images (or) simultaneously.
RAW		
RAW	RAW	This records RAW images.



Note on RAW

RAW format refers to a data format of images that have not been processed on the camera.

Playback and editing of RAW images require the camera or the dedicated software.

- You can process RAW images on the camera. (→286)
- Use software ("SILKYPIX Developer Studio" by Ichikawa Soft Laboratory) to process and edit RAW files on a PC. (→442)
- Pictures taken with [RAW] cannot be displayed enlarged to the maximum magnification during playback.

Take pictures with [RAW[●]] or [RAW_●] if you want to check their focus on the camera after recording.



- RAW images are always recorded in the [L] size of the [4:3] aspect ratio.
- When you delete an image recorded with [RAW[●]] or [RAW_●] on the camera, both the RAW and JPEG images will be deleted simultaneously.
- [RAW[●]], [RAW_●] and [RAW] are not available when using the following function:
 - [SCN] mode ([Handheld Night Shot])
- When the following functions are being used, [Quality] is not available:
 - [4K PHOTO], [Post Focus]
 - [Multi Exp.]

[Folder / File Settings]

Set the folder and file name where to save the images.

Folder name		File name	
100ABCDE 		PABC0001.JPG 	
①	Folder number (3 digits, 100 to 999)	③	Color space ([P]: sRGB, [_]: AdobeRGB)
②	5-character user-defined segment	④	3-character user-defined segment
		⑤	File number (4 digits, 0001 to 9999)
		⑥	Extension

⇒ ⇒ Select [Folder / File Settings]

[Select Folder]	Selects a folder for storing images.	
[Create a New Folder]	Creates a new folder with an incremented folder number. • If there are no recordable folders in the card, a screen for resetting the folder number is displayed.	
	[OK]	Increments the folder number without changing the 5-character user-defined segment (② above).
	[Change]	Changes the 5-character user-defined segment (② above). This will also increment the folder number.
[File Name Setting]	[Folder Number Link]	Uses the 3-character user-defined segment (④ above) to set the folder number (① above).
	[User Setting]	Changes the 3-character user-defined segment (④ above).

- Available characters: alphabetic characters (upper-case), numerals, [_] (refer to "Entering Characters" (→370))



- Each folder can store up to 1000 files.
- File numbers are assigned sequentially from 0001 to 9999 in the order of recording.

If you change the storage folder, a number continuing on from the last file number will be assigned.

- In the following cases, a new folder with an incremented folder number will be created automatically when the next file is saved:
 - The number of files in the current folder reaches 1000.
 - The file number reaches 9999.
- New folders cannot be created when there are folders numbered from 100 all the way up to 999.

We recommend backing up your data and formatting the card.

[No.Reset]

Refresh the folder number to reset the file number to 0001.

 → [] → Select [No.Reset]



- When the folder number reaches 999, the number cannot be reset. We recommend backing up your data and formatting the card.
- **To reset the folder number to 100:**
 - ① Perform [Format] to format the card. (→40)
 - ② Perform [No.Reset] to reset the file number.
 - ③ Select [Yes] on the folder number reset screen.

6. Focus/Zoom

Selecting the Focus Mode



Select the focusing method (focus mode) to match subject movement.

Set the Focus Mode.

- → / → [Focus Mode]



[AFS]	This is suitable for recording still subjects. When the shutter button is pressed halfway, the camera focuses once. The focus stays locked while the shutter button is pressed halfway.
[AFF]*1	This is suitable for recording subjects with movements that cannot be predicted. If the subject moves while the shutter button is pressed halfway, the focus is readjusted automatically according to the movement of the subject.
[AFC]*1	This is suitable for recording moving subjects. While the shutter button is pressed halfway, the focus is constantly adjusted according to the movement of the subject.
[MF]	Manual focusing. Use this when you want to fix the focus or avoid activating AF. (→146)

*1 This predicts the movement of the subject, maintaining focusing. (Movement prediction)



- In the following cases, [AFF] or [AFC] works the same as [AFS] when the shutter button is pressed halfway:
 - [AFM] mode, [S&Q] mode
 - [4K Burst(S/S)]
 - In low light situations
- [AFF] is not available when recording 4K photos. Continuous AF works during recording.
- This function is not available for Post-Focus recording.

Using AF



AF (Auto Focus) refers to automatic focusing.

Select the focus mode and the AF mode appropriate for the subject and scene.

1 Set the Focus Mode. (→124)

- **MENU/SET** → [CAMERA]/[VIDEO] → [Focus Mode] → [AFS]/[AFF]/[AFC]

2 Select AF mode.

- Press [**AF**] (◀) to display the AF mode selection screen, and set using **MENU/SET**. (→129)
- In [**iA**]/[**iA+**] mode, each press of [**AF**] (◀) switches between [**iA**] and [**iA+**]. (→78)

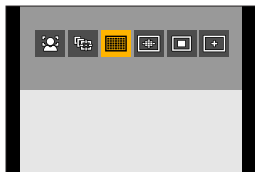

3 Press the shutter button halfway.

- The AF operates.

- (A) Focus display
- (B) AF area

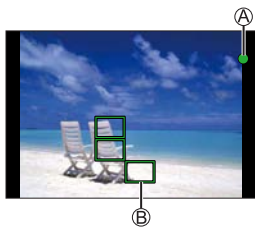

	Focus	
	In focus	Not in focus
Focus display	Lights	Blinking
AF area	Green	—
AF beep	Two beeps	—

Low illumination AF

- In dark environments, low illumination AF automatically operates, and the focus display is indicated as [●_{LOW}].
- Achieving focus may take more time than usual.

Starlight AF

- If the camera detects stars in the night sky after determining low illumination AF, then Starlight AF will be activated.
When focus is achieved, the focus display will display [●_{STAR}], and the AF area will be displayed on the area in focus.
- Edges of the screen cannot detect Starlight AF.



Subjects and recording conditions that make focusing difficult with AF mode

- Fast-moving subjects
- Extremely bright subjects
- Subjects without contrast
- Subjects recorded through windows
- Subjects near shiny objects
- Subjects in very dark locations
- When recording subjects both distant and near



- When the following operations are performed while recording with [AFF] or [AFC], it may take some time for the camera to focus.
 - When zooming from the wide-angle end to the telephoto end
 - When the subject is suddenly changed from one far away to one close by
- If using the zoom after achieving focus, the focus may be erroneous. In that case, re-adjust the focus.



- You can release the shutter quickly by pressing the shutter button halfway:
[🔧] ⇒ [FOCUS] ⇒ [Half Press Release] (→331)
- When camera shake reduces, it is possible to focus automatically:
[🔧] ⇒ [FOCUS] ⇒ [Quick AF] (→332)

[AF Sensitivity(Photo)]



Sets the tracking sensitivity for the movement of subjects.

1 Set the focus mode to [AFF] or [AFC]. (→124)

2 Set [AF Sensitivity(Photo)].

-  →  → [AF Sensitivity(Photo)]



+

When the distance to the subject changes drastically, the camera re-adjusts the focus immediately. You can bring different subjects into focus one after another.

-

When the distance to the subject changes drastically, the camera waits for a short period of time before re-adjusting the focus. This allows you to prevent the focus from being accidentally re-adjusted when, for example, an object moves across the image.



- When the following functions are being used, [AF Sensitivity(Photo)] is not available:
 - [4K PHOTO], [Post Focus]

Selecting the AF Mode



Select the focusing method to match the position and number of subjects.

1 Press [AF] (◀).

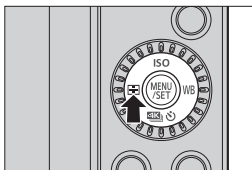

2 Select the AF mode.

- Press ◀▶ to select an item and then press .
- Selection is also possible by rotating or .

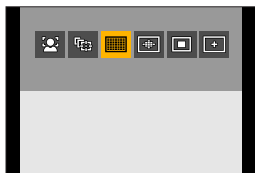

	[Face/Eye Detection] →131
	[Tracking] →133
	[49-Area] →135
etc.	→136 →138
	[1-Area] →139
	[Pinpoint] →140



- When the following functions are being used, [Face/Eye Detection] is not available:
 - [Clear Nightscape], [Cool Night Sky], [Warm Glowing Nightscape], [Artistic Nightscape], [Glittering Illuminations], [Handheld Night Shot], [Appetizing Food], [Cute Dessert] ([SCN] mode)
- When the following functions are being used, [Time Lapse Shot] is not available:
 - [Time Lapse Shot]
 - [Live View Composite]
- When the focus mode is set to [AFF] or [AFC], [AF+ Lock] is not available.
- When the following function is being used, the AF mode is fixed to [Face/Eye Detection] ([Face/Eye Detection]):
 - Self Shot Mode (If [Face/Eye Detection] in AF Mode is not available with the current Recording Mode, an available focus setting for each Recording Mode will be used.)
 - [4K Live Cropping]
- When the following functions are being used, the AF mode is fixed to [AF-Lock]:
 - [Digital Zoom]
 - [Miniature Effect] ([Miniature Effect] mode)
- When the following functions are being used, [AF Mode] is not available:
 - [Post Focus]
 - [Pull Focus] ([Snap Movie])
- When [Digital Zoom] is set, it is not possible to move the AF area or change its size.

[Face/Eye Detection]

The camera automatically detects the faces and eyes of subjects.

When the camera detects a person's face

Ⓐ/Ⓑ, an AF area is displayed.

Yellow	AF area to be brought into focus. The camera selects this automatically.
White	Displayed when multiple subjects are detected.

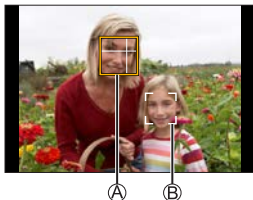



- Eye detection works only for the eyes inside the yellow frame Ⓐ.

Specify the Eye to Bring into Focus

① Touch the eye to be used for focusing.

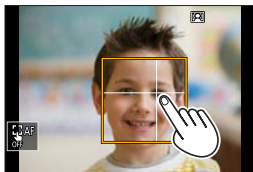
- To cancel the settings specified, touch



- The eye to be in focus cannot be changed when [4K Live Cropping] is set.
- When a person's eyes are detected, the eye closer to the camera will be brought into focus.
The exposure will be adjusted to the face. (When [Metering Mode] is set to )
- The camera can detect the faces of up to 15 people.
- If any humans are not detected, the camera operates as .



- During recording, you can make the sound pickup range of the built-in mic work with the face/eye detection function:

 ⇒ [Built-in Mic] (→265)

❖ Move and Change the Size of the Yellow AF Area

- 1 Press **[DISP.]** (**◀**) to display the AF mode selection screen.
- 2 Select **[AF]** and then press **▼**.
- 3 Press **▲▼◀▶** to move the position of the AF area.
- 4 Rotate **☀** or **⚙** to change the size of the AF area.
- 5 Press **MENU/SET**.
 - On the recording screen, press **MENU/SET**, or touch **[AF OFF]** to cancel the AF area setting.

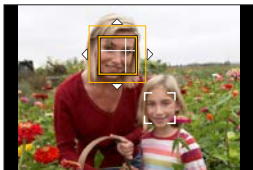



Operations on the AF area movement screen

Button operation	Touch operation	Description of operation
▲▼◀▶	Touch	Moves the AF area.
☀	Pinch out/ pinch in	Enlarges/reduces the AF area in small steps.
⚙	—	Enlarges/reduces the AF area.
[DISP.]	[Reset]	First time: Returns the AF area position to the center. Second time: Returns the AF area size to the default setting.





[Tracking]

The AF area follows the movement of the subject, maintaining focusing.

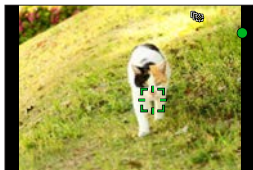

Start tracking.

- Aim the AF area over the subject, and press the shutter button halfway.
- When the subject is recognized, the AF tracking area turns green. When you release the shutter button, the AF tracking area turns yellow and the subject is automatically kept in focus.
- The same operation can be performed by touching the subject.
- To release AF Tracking
→ Touch  or press .
- If tracking fails, the AF area blinks red.



- Set [Metering Mode] to  to continue to adjust the exposure as well.
- In the following,  operates as :
 - [Glistening Water], [Glittering Illuminations], [Soft Image of a Flower], [Monochrome] ([SCN] mode)
 - [Sepia], [Monochrome], [Dynamic Monochrome], [Rough Monochrome], [Silky Monochrome], [Soft Focus], [Star Filter], [Sunshine] ( mode)
 - [Monochrome], [L.Monochrome], [L.Monochrome D] ([Photo Style])
 - When the subject is small

❖ Move the Position of the AF Area

- 1 Press [] (◀) to display the AF mode selection screen.
- 2 Select [] and then press ▼.
- 3 Press ▲ ▼ ◀ ▶ to move the position of the AF area.
 - You can also move the AF area by touching.
 - To return the position back to the center, press [DISP.].
- 4 Press .

[49-Area]

The camera selects the most optimal AF area to focus from 49 areas.

When multiple AF areas are selected, all selected AF areas will be brought into focus.

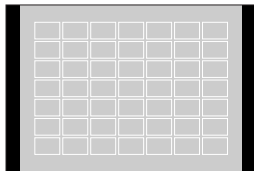





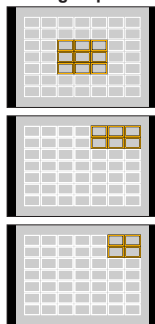

❖ Move and Change the Size of the AF Area

You can set the focus position by selecting an AF area group. The AF area, which is configured with 49 points, is divided into groups consisting of 9 points each (6 points or 4 points for the groups located at the edges of the screen).

Examples of group



- 1 Press  (◀) to display the AF mode selection screen.
- 2 Select  and press ▼.
- 3 Press ▲ ▼ ◀ ▶ to select an AF area group.
 - You can also move the AF area by touching.
 - To return the AF area position to the center, press [DISP.].
- 4 Press .
 - Setting of the AF area is cleared when  is pressed or  is touched.

 • The display method for the AF area using 49-area focusing can be changed:
 ⇒ [FOCUS] ⇒ [AF Area Display] (→ 335)



Custom Multi (Horizontal, Vertical, Center)

[Horizontal Pattern]

Ideal shape for panning, etc.



[Vertical Pattern]

Ideal shape for recording structures, etc.

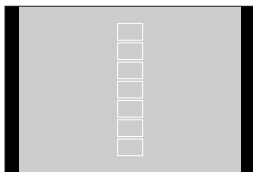

[Central Pattern]

Within the 49 AF areas, a central oval zone can be focused.

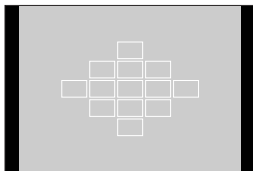

❖ Move and Change the Size of the AF Area

- 1 Press (◀) to display the AF mode selection screen.
- 2 Select a Custom Multi icon (), etc.), and press ▲.
- 3 Select , or and then press ▼.



- 4 Press ▲ ▼ ◀ ▶ to move the position of the AF area.
 - You can also move the AF area by touching.

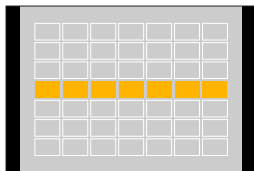

- 5 Rotate or to change the size of the AF area.
 - You can also pinch out/pinch in the AF area to change the size.
 - The first press of [DISP.] returns the AF area position to the center. The second press returns the size of the AF area to the default.
- 6 Press .

Registering the set AF area in , and (Custom)

- 1 Press ▲ on the screen of step 3.
- 2 Use ▲ ▼ to select the registration target icon and press .



• The settings adjusted in , or will be restored to the default settings when the camera is turned off.



• The display method for the AF area using 49-area focusing can be changed: → → [AF Area Display] (→ 335)

C1 C2 C3 Custom Multi (C1 to C3)

The shape of the AF area can be set freely in the 49 AF areas. The set AF area can be registered using [C1] to [C3].

- 1 Press [+] (◀) to display the AF mode selection screen.
- 2 Select a Custom Multi icon ([+] etc.), and press ▲.
- 3 Select one of [C1] to [C3] and then press ▼.



- 4 Select the AF area.
 - Touch operation
Touch the area to make the AF area.
 - To select consecutive points, drag the screen.
 - To cancel selection of the selected AF area, touch it again.

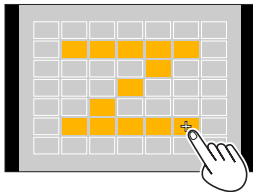

- Button operation
Press ▲▼◀▶ to select the AF area and then set with .
(Repeat this)
 - To cancel selection of the selected AF area, press again.
 - To cancel all selections, press [DISP].

- 5 Press [Fn4].



- The display method for the AF area using 49-area focusing can be changed:
[Fn] ⇒ [FOCUS] ⇒ [AF Area Display] (→335)

▣ [1-Area]

Specify the point to be brought into focus.

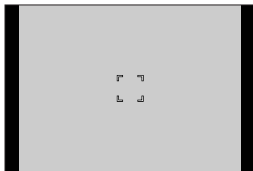

❖ Move and Change the Size of the AF Area

- ① Press [] (◀) to display the AF mode selection screen.
- ② Select [] and then press ▼.
- ③ Press ▲▼◀▶ to move the position of the AF area.
- ④ Rotate 🌞 or ⚙️ to change the size of the AF area.
- ⑤ Press MENU/SET.



- Refer to "Operations on the AF area movement screen" on page 132 for information about detailed operations to move the AF area.



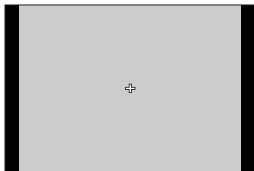

[Pinpoint]

You can achieve a more precise focus on a small point.

If you press the shutter button halfway, the screen that lets you check the focus will be enlarged.



❖ Move the Position of the AF Area

- ① Press  (◀) to display the AF mode selection screen.
- ② Select  and then press ▼.
- ③ Press ▲ ▼ ◀ ▶ to set the position of [+]. and then press .
 - The selected position on the screen will be enlarged.
 - The AF area cannot be moved to the edge of the screen.
- ④ Press ▲ ▼ ◀ ▶ to fine-adjust the position of [+].
- ⑤ Press .

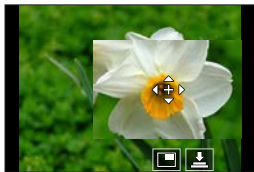

Operations on the Magnification Window

Button operation	Touch operation	Description of operation
	Touch	Moves [+].
	Pinch out/ pinch in	Enlarges/reduces the screen in small steps.
	—	Enlarges/reduces the screen.
—		Switches magnification window (windowed mode/full screen mode).
[DISP.]	[Reset]	First time: Returns to the screen in Step ③. Second time: Returns the AF area position to the center.

- When the picture is displayed in windowed mode, you can enlarge the picture by approx. 3x to 6x; when the picture is displayed in full screen, you can enlarge the picture by approx. 3x to 10x.
- You can also take a picture by touching [].



- When the following functions are being used, [] switches to []:
– Video recording, [4K PHOTO]



- You can change the display method of the magnified screen:
[] ⇒ [] ⇒ [Pinpoint AF Setting] (→ 332)

Moving the AF Area by Touch

You can move the AF area to a touched position on the monitor.

Optimizing the focus and brightness to the touched position

Set [Touch AF].

-  →  →  → [Touch Settings] → [Touch AF]

[AF]	This focuses on the touched subject.
[AF+AE]	This focuses on and adjusts brightness for the touched subject.

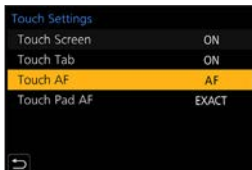







- The default setting is [AF].

❖ Focus on the Touched Position ([AF])

- 1 Touch the subject.
 - The AF area moves to the touched position.

Size of the AF area can be set when AF Mode is in the following cases:

-  ([Face/Eye Detection]),  ([1-Area]),  ([Pinpoint])
-  etc. ([Vertical Pattern], [Horizontal Pattern] or [Central Pattern] of Custom Multi)

- 2 Pinch out/pinch in to change the AF area size.
 - The first touch of [Reset] returns the AF area position to the center. The second touch returns the size of the AF area to the default.
 - With , operations will be on a magnified screen. (→ 141)
- 3 Touch [Set].
 - In , touch [Exit].

❖ Focus on and Adjust Brightness for the Touched Position ([AF+AE])

① Touch the subject to which you wish to adjust the brightness.

- At the touched position, an AF area that works in the same way as [] is displayed.

This places a point to adjust brightness at the center of the AF area.

- [Metering Mode] is set to [AE], which is used exclusively for the [Touch AE].



② Pinch out/pinch in to change the AF area size.

- The first touch of [Reset] returns the AF area position to the center. The second touch returns the size of the AF area to the default.

③ Touch [Set].

- The [AF+AE] area setting is canceled if you touch [] (when [] is set: [])



- When the following functions are being used, [AF+AE] is not available:
 - [Digital Zoom]
 - [4K Live Cropping]

Moving the AF Area during Viewfinder Display

During viewfinder display, you can touch the monitor to change the position and size of the AF area.

1 Set [Touch Pad AF].

-  → [C/W] →  → [Touch Settings] → [Touch Pad AF] → [EXACT]/[OFFSET1] to [OFFSET7]

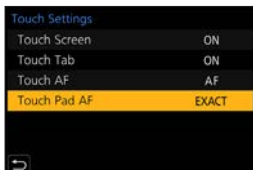

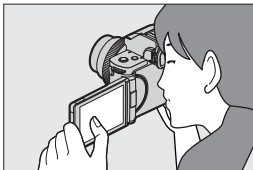

2 Move the position of the AF area.

- During viewfinder display, touch the monitor.



3 Change the size of the AF area.

- Rotate  or .
- The first press of [DISP.] returns the AF area position to the center. The second press returns the size of the AF area to the default.

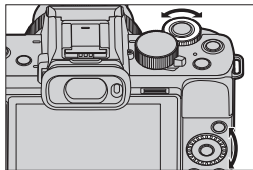

4 Confirm your selection.

- Press the shutter button halfway.

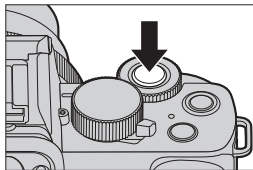

❖ Setting Items ([Touch Pad AF])

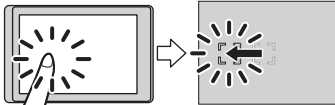
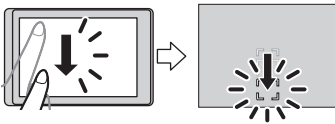
[EXACT]	Moves the AF area of the viewfinder by touching a desired position on the touch pad.	 <p>The diagram shows a viewfinder on the left with a finger touching a specific point. An arrow points to the right, where a touch pad is shown with a corresponding AF area centered on that point.</p>
[OFFSET1] to [OFFSET7]	<p>Moves the AF area of the viewfinder according to the distance you drag your finger on the touch pad.</p> <p>Select the range to be detected with the drag operation. [OFFSET1] (entire area)/[OFFSET2] (right half)/ [OFFSET3] (upper right)/[OFFSET4] (lower right)/ [OFFSET5] (left half)/[OFFSET6] (upper left)/ [OFFSET7] (lower left)</p>	 <p>The diagram shows a viewfinder on the left with a finger being dragged downwards. An arrow points to the right, where a touch pad is shown with a downward-pointing arrow and an AF area positioned accordingly.</p>
[OFF]	—	—



- When the following functions are being used, [Touch Pad AF] is not available.
 - [4K Live Cropping]
 - [Pull Focus] in [Snap Movie]

Record Using Manual Focus



MF (Manual Focus) refers to manual focusing.

Use this function when you want to fix the focus or when the distance between the lens and the subject is determined and you do not want to activate AF.

1 Set the Focus Mode.

- Press **[MENU/SET]** → **[CAMERA]** → **[Focus Mode]** → **[MF]**
- Press the shutter button halfway to return to the recording screen.



2 Press **[DISP.]** (◀).

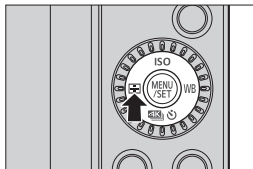

3 Select the focus point.

- Press **▲▼◀▶** to select the focus point.
- To return the point to be brought into focus to the center, press **[DISP.]**.

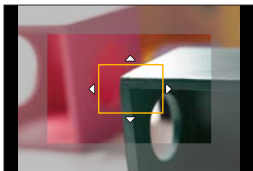

4 Confirm your selection.

- Press .
- This switches to the MF Assist screen, and shows an enlarged display.

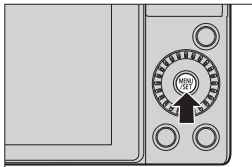

5 Adjust the focus.

The operations used to focus differ depending on the lens.

When using an interchangeable lens with no focus ring

Press  : Focuses on nearby subject

Press  : Focuses on distant subject

(A) Slide bar



- Pressing and holding  will increase the focus speed.
- Focus can also be adjusted by dragging the slide bar.

When using an interchangeable lens with a focus ring

Rotate to (A) side: Focuses on nearby subject

Rotate to (B) side: Focuses on distant subject

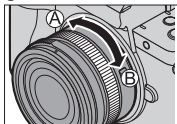

When using the interchangeable lens having a focus lever

Move to (C) side: Focuses on nearby subject

Move to (D) side: Focuses on distant subject

- The focusing speed varies depending on how far you move the focus lever.

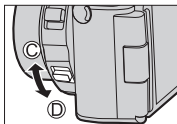

- This will display the in-focus portion highlighted with color. (Focus Peaking)
- A recording distance guideline is displayed. (MF Guide)

- Ⓐ MF Assist (enlarged screen)
- Ⓑ Focus Peaking
- Ⓒ MF Guide

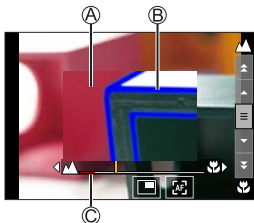

6 Close the MF Assist screen.





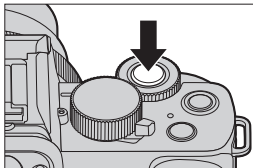

- Press the shutter button halfway.
- This operation can also be performed by pressing .

7 Start recording.

- Press the shutter button fully.

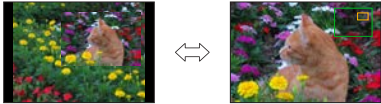

❖ Operations on the MF Assist Screen

Button operation	Touch operation	Description of operation
 *1	Drag	Moves the enlarged display position.
	Pinch out/ pinch in	Enlarges/reduces the screen in small steps.
	—	Enlarges/reduces the screen.
—	 *2	Switches magnification window (windowed mode/full screen mode)*3. 
[DISP.] *1	[Reset] *1	First time: Returns the MF Assist position to the center. Second time: Returns the MF Assist magnification to the default setting.
—		The AF operates.*4

*1 When using an interchangeable lens with no focus ring, you can perform these operations after pressing ▼ to display the screen that lets you set the area to be enlarged.

*2 Cannot be set when using [iA] mode.

*3 When the picture is displayed in windowed mode, you can enlarge the picture by approx. 3x to 6x; when the picture is displayed in full screen, you can enlarge the picture by approx. 3x to 20x.

*4 Auto Focus also works with the following operations.

- Pressing the Fn button to which [AF-ON] is assigned (→210)
- Dragging the monitor and releasing your finger at the position you want to focus on



- On the recording screen, you can rotate the focus ring to display the MF Assist screen. If the focus ring has been rotated to enlarge the display, the assist screen will be exited a certain amount of time after you cease the operation.

- The recording distance reference mark is a mark used to measure the recording distance.

Use this when taking pictures with manual focusing or taking close-up pictures.

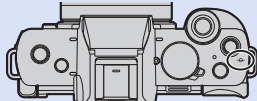

- When using an interchangeable lens with no focus ring and in the following cases, manual focus operations may not be possible during recording if the shutter speed is very slow.

- [M] mode (When [Exposure Mode] is set to [M])
- [S&Q] mode (When [S&Q Exposure Mode] is set to [M])

(When using an interchangeable lens with a focus ring, you can do manual focus operations, but autofocus does not work during manual focus.)

- MF Assist and MF Guide may not display depending on the lens used. You can, however, display MF Assist by directly operating the camera using the touch screen or a button.



- You can memorize the MF Assist position separately for vertical and horizontal orientations:

[Focus] → [Focus] → [Focus Switching for Vert / Hor] (→335)

- You can set the movement of the MF Assist position to loop:

[Focus] → [Focus] → [Loop Movement Focus Frame] (→335)

- You can change the display method of the magnified screen:

[Focus] → [Focus] → [MF Assist] (→336)

- You can disable focus ring operation:

[Focus] → [Focus Ring Lock] (→339)

- You can change the Focus Peaking sensitivity and the display method:

[Focus] → [Peaking] (→342)

- You can change the MF Guide display:

[Focus] → [MF Guide] (→345)

- The camera memorizes the focus point when you turn it off:

[Focus] → [Lens Position Resume] (→347)

Recording with Zoom



Use the optical zoom of the lens to zoom to telephoto or wide-angle.

T : Telephoto, Enlarges distant subject

W : Wide-angle, Widens angle of view

<p>Interchangeable lens with a zoom ring</p>	<p>Rotate the zoom ring.</p>	
<p>Interchangeable lens that supports the power zoom (electrically operated zoom)</p>	<p>Move the zoom lever. (The zoom speed varies depending on how far you move the lever.)</p> <ul style="list-style-type: none"> If you set [Zoom Control] to an Fn button, you can operate the optical zoom slowly by pressing ◀▶ or fast by pressing ▲▼. 	
<p>Interchangeable lens that does not support the zoom</p>	<p>The optical zoom is not available.</p>	

Extended Tele Conversion

[Ex. Tele Conv.] enables you to take pictures that are further enlarged beyond what is available with the optical zoom, without any deterioration in image quality.

❖ [Ex. Tele Conv.] ([Rec])



- The [Ex. Tele Conv.] maximum magnification ratio differs depending on the [Picture Size] and [Aspect Ratio] set in the [Rec] menu.
 - When the setting is set to [EX M]: up to 1.4x
 - When the setting is set to [EX S]: up to 2.0x

① Set [Picture Size] to [M] or [S].



- → → [Picture Size] → [M]/[S]

② Set [Ex. Tele Conv.].

- → → [Ex. Tele Conv.]





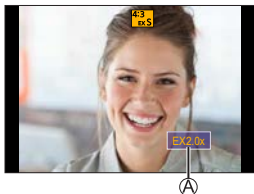

[ZOOM]	Changes the zoom magnification.
[TELE CONV.]	Fixes the zoom magnification at the maximum.
[OFF]	—

Changing the Zoom Magnification (Button operation)

- 1 Set [Ex. Tele Conv.] to [ZOOM].
 -  →  → [Ex. Tele Conv.] → [ZOOM]
 - 2 Set the Fn button to [Zoom Control]. (→ 292)
 - 3 Press the Fn button.
 - 4 Press the cursor buttons to operate the zoom.
 - ▲▶ : T (telephoto)
 - ◀▼ : W (wide-angle)
 - Press the Fn button again, or wait a specified time to end zoom operation.
-  Zoom magnifications



Changing the Zoom Magnification (Touch operation)

- 1 Set [Ex. Tele Conv.] to [ZOOM].
 -  →  → [Ex. Tele Conv.] → [ZOOM]
 - 2 Touch .
 - 3 Touch .
- 4 Drag the slide bar to operate the zoom.
 -  : Telephoto
 -  : Wide-angle
 - To end Touch Zoom operations, touch  again.



❖ [Ex. Tele Conv.] ([Motion Picture])



- ① Set [Rec Quality] to [FHD] or [HD].
 - ⇒ ⇒ [Rec Quality] ⇒ [FHD]/[HD]
- ② Set [Ex. Tele Conv.].
 - ⇒ ⇒ [Ex. Tele Conv.]

[ON]	Fixes the zoom magnification at the maximum.
[OFF]	—



- If you assign [Ex. Tele Conv.] to [Fn Button Set] in the [Custom] ([Operation]) menu, you can display the Extended Tele Conversion setting screen for both pictures and video by pressing the assigned Fn button. While this screen is displayed, you can change the [Picture Size] setting by pressing [DISP].



- When the following functions are being used, [Ex. Tele Conv.] is not available:
 - [Toy Effect], [Toy Pop] () mode)
 - [RAW] ([Quality])
 - [4K PHOTO], [Post Focus]
 - [HDR]
 - [Multi Exp.]
 - [4K Live Cropping]
- [Ex. Tele Conv.] ([Rec]) is not available in the following case.
 - [Handheld Night Shot] ([SCN] mode)
- [Ex. Tele Conv.] ([Motion Picture]) is not available in the following case.
 - When using the HDMI output during recording (Except in) mode)
- During Self Shot Mode, you cannot perform zoom operation by touching.

[Digital Zoom]



You can increase the zoom ratio 2x higher than the original zoom ratio. Note that, with Digital Zoom, enlarging will decrease picture quality.

→ /[] → Select [Digital Zoom]

Settings: [2x]/[OFF]



- When using [Digital Zoom], we recommend using a tripod and the self-timer (→ 184) for taking pictures.



- When the following functions are being used, [Digital Zoom] is not available.
 - [Toy Effect], [Toy Pop], [Miniature Effect] ([] mode)
 - [RAW], [RAW], [RAW] ([Quality])
 - [Post Focus]
 - [HDR]
 - [Multi Exp.]

Power Zoom Lens



Sets the screen display and operations when using an interchangeable lens that is compatible with power zoom (electrically operated zoom).

- This may only be selected when using a lens that is compatible with power zoom (electrically operated zoom).

MENU/SET → [C/W] → [Z] → Select [Power Zoom Lens]

<p>[Disp Focal Length]</p>	<p>Displays the focal length on the recording screen during zoom control.</p> <p>Ⓐ Focal distance indication Ⓑ Current focal distance</p>	
<p>[Step Zoom]</p>	<p>When you operate the zoom with this setting [ON], the zoom will stop at positions corresponding to predetermined distances.</p> <p>Ⓒ Step zoom indication</p> <p>This setting does not work when recording video or 4K photos with [4K PRE] ([4K Pre-Burst]).</p>	
<p>[Zoom Speed]</p>	<p>You can set the zoom speed for zoom operations.</p> <ul style="list-style-type: none"> If you set [Step Zoom] to [ON], the zoom speed will not change. <p>[Photo]: [H] (High speed) / [M] (Middle speed) / [L] (Low speed) [Video]: [H] (High speed) / [M] (Middle speed) / [L] (Low speed)</p>	
<p>[Zoom Ring]</p>	<p>This may only be selected when a power zoom-compatible lens with a zoom lever and zoom ring is attached.</p> <p>When set to [OFF], the operations controlled by the zoom ring are disabled to prevent accidental operation.</p>	

7. Drive/Shutter/Image Stabilizer

Selecting the Drive Mode



You can switch the drive mode to Single, Burst, etc. to match the recording conditions.

1 Press [**4K**] (▼).

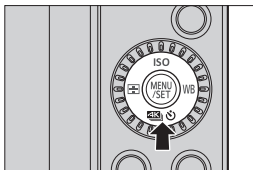

2 Select the drive mode.

- Press ◀▶ to select the drive mode and press .
- You can also select by rotating .

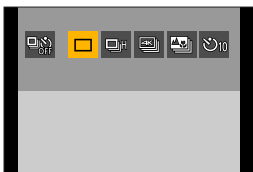

[Single]	Takes one picture each time the shutter button is pressed.
[Burst] (→ 158)	Takes pictures continuously while the shutter button is pressed and held.
[4K PHOTO] (→ 162)	When the shutter button is pressed, a picture is recorded with the 4K Photo function.
[Post Focus] (→ 176)	When the shutter button is pressed, the pictures are recorded with [Post Focus].
[Self Timer] (→ 184)	Takes pictures when the set time elapses after the shutter button is pressed.

- Select [Off] to return to [Single] (default setting).

Taking Burst Pictures



Takes pictures continuously while the shutter button is pressed and held.

1 Press **[]** **[]** (**▼**).

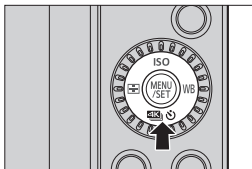

2 Press **◀▶** to select **[Burst]** and press **▲**.

- You can also select by rotating .

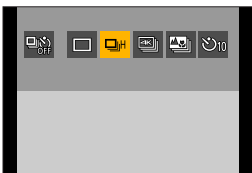

3 Select the burst rate.

- Press **◀▶** to select the burst rate and press **MENU/SET**.
Settings: **[H]** (High speed)/
[M] (Middle speed)/
[L] (Low speed)

- You can also select by rotating or .
- The burst rate can also be set using **[Burst Rate]** in the **[Rec]** menu.

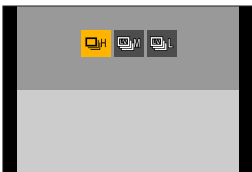

4 Start recording.

- Takes burst pictures while the shutter button is pressed fully.

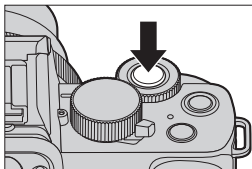





❖ Burst Rate

	Electronic front curtain	Electronic shutter	Live View when taking burst pictures
[H] High speed	6 frames/second ([AFS]/[MF]) 5 frames/second ([AFF]/[AFC])	10 frames/second ([AFS]/[MF]) 10 frames/second ([AFF]/[AFC])	None ([AFS]/[MF]) Available ([AFF]/[AFC])
[M] Medium speed	4 frames/second	4 frames/second	Available
[L] Low speed	2 frames/second	2 frames/second	Available

- The burst rate may be lower depending on the settings for recording such as [Picture Size] and focus mode.

❖ Maximum Number of Frames Recordable

	[Quality]	
	 / 	RAW  / RAW  / RAW
[H] High speed	480 frames or more	20 frames or more
[M] Medium speed		
[L] Low speed		

- When recording under the test conditions specified by Panasonic. Recording conditions may reduce the maximum number of frames recordable.
- The burst rate will become lower during recording but pictures can continue to be taken until the card becomes full.

❖ Number of Pictures That Can Be Taken Continuously

When you press the shutter button halfway, the number of pictures that can be taken continuously will appear on the recording screen.

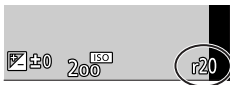

Example) When 20 frames: [r20]

- Once recording starts, the number of pictures that can be taken continuously will decrease. When [r0] appears, the burst rate decreases.
- When [r99+] is displayed on the recording screen, you can take 100 or more burst pictures.

❖ Focus when Taking Burst Pictures





Focus mode	[Focus/Release Priority] (→334)	[H]	[M]/[L]
[AFS]	[FOCUS]	Fixed to the focus of the first frame	
	[BALANCE]		
	[RELEASE]		
[AFF]/[AFC]	[FOCUS]	Estimated focus	Normal focus
	[BALANCE]	Estimated focus	
	[RELEASE]		
[MF]	—	Focus set with manual focus	

- When the subject is dark with [AFF] or [AFC], the focus is fixed to that of the first frame.
- With estimated focus, the burst rate takes priority and the focus is estimated to the extent possible.
- With normal focus, the burst rate may become slow.

❖ Exposure when Taking Burst Pictures

Focus mode	[H]	[M]/[L]
[AFS]	Fixed to the exposure of the first frame	The exposure is adjusted for each frame
[AFF]/[AFC]	The exposure is adjusted for each frame	
[MF]	Fixed to the exposure of the first frame	

❖ How to Cancel [Burst]

Press [] () (▼), and then select [] ([Single]) or [] (OFF).



- It may take a while to save burst pictures.
If you continue to take burst pictures while saving is in progress, the maximum number of frames recordable will be reduced.
When taking burst pictures, we recommend using a high-speed card.
- Taking burst pictures does not work while you are using the following functions:
 - Self Shot Mode
 - [Glistening Water], [Glittering Illuminations], [Handheld Night Shot], [Soft Image of a Flower] ([SCN] mode)
 - [Rough Monochrome], [Silky Monochrome], [Miniature Effect], [Soft Focus], [Star Filter], [Sunshine] ([] mode)
 - Flash
 - [Time Lapse Shot]
 - [Stop Motion Animation] (when [Auto Shooting] is set)
 - [Live View Composite]
 - [Multi Exp.]

4K Photo Recording



With 4K photo, you can take high-speed burst pictures at 30 frames/second and save the desired pictures, each made up of approx. 8 million pixels.



- Use a UHS Speed Class 3 or higher card when recording.
- The angle of view becomes narrower.
- When the recording time of a single session exceeds 10 minutes, recording stops.
- If the camera temperature rises, [] may be displayed and recording may stop. Wait until the camera cools down.

1 Press [ ] (▼).

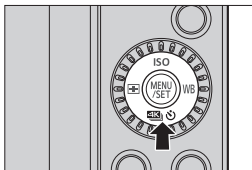



2 Press ◀▶ to select [4K PHOTO] and press ▲.

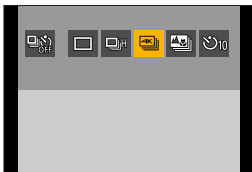

- You can also select by rotating .

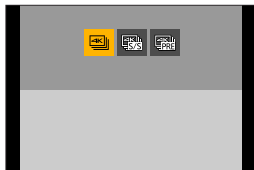

3 Select [Rec Method].

- Press ◀▶ to select the recording method and press .
- You can also select by rotating  or .
- The recording method can also be set using [4K PHOTO] in the [Rec] menu.



 ([4K Burst])	<p>When you wish to capture the best moments of a fast-moving subject Takes burst pictures while the shutter button is pressed.</p> <p>Audio recording: None</p>	
 ([4K Burst(S/S)]) "S/S" is an abbreviation for start/stop.	<p>When you wish to capture an unpredictable photo opportunity Starts taking burst pictures when the shutter button is pressed. Pressing the button again stops taking burst pictures. The start tone and stop tone are output.</p> <p>Audio recording: Available*¹</p>	
 ([4K Pre-Burst])	<p>When you wish to capture at the moment of a photo opportunity Takes burst pictures for approx. 1 second before and after the moment the shutter button is pressed. The shutter sound is output once only.</p> <p>Recording duration: Approx. 2 seconds</p>	<p>Audio recording: None</p>

*1 Audio is not played back during playback with the camera.

4 Start recording.

- [Continuous AF] works and the focus is adjusted continuously during recording with AF.

[4K Burst]

- 1 Press the shutter button halfway.
- 2 Press the shutter button fully and keep it pressed during recording.

- Ⓐ Press and hold
- Ⓑ Recording is performed

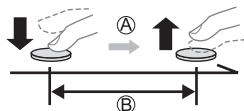

- Press the shutter button fully early because recording will take approx. 0.5 seconds to start after it is pressed fully.

[4K Burst(S/S)]

- 1 Press the shutter button fully to start recording.
- 2 Press the shutter button fully again to stop recording.

- Ⓒ Start (First)
- Ⓓ Stop (Second)
- Ⓔ Recording is performed

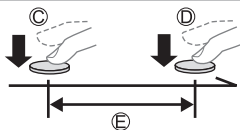

- You can add markers (white marker) by pressing [Fn2] during recording. (Up to 40 markers per recording)
This allows you to skip to the positions where you added markers when selecting pictures from a 4K burst file.

[4K Pre-Burst]

Press the shutter button fully.

F Approx. 1 second

G Recording is performed

- While the recording screen is displayed, the AF will operate constantly to continue focusing.
The exposure is also adjusted continuously, except in **[M]** mode.
- When the subject is not at the center, use AF/AE Lock if you wish to lock the focus and exposure. (→ 210)

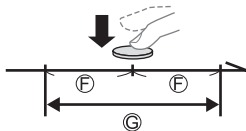

- In default settings, Auto Review operates, and a screen that lets you select pictures from a burst file will be displayed.
To continue recording, press the shutter button halfway to return to the recording screen.
For how to select and save pictures from a recorded 4K burst file, refer to page 168.

❖ [Pre-Burst Recording] ([4K Burst]/[4K Burst(S/S)])

The camera starts recording approx. 1 second before the shutter button is pressed fully, so you will not miss a photo opportunity.

MENU/SET → **[CAMERA]** → **[4K PHOTO]** → Select [Pre-Burst Recording]

Settings: **[ON]**/**[OFF]**

- When [Pre-Burst Recording] is being used, **[PRE]** is displayed on the recording screen.
- The AF behavior and functionality restrictions when using [Pre-Burst Recording] are the same as for [4K Pre-Burst].

❖ How To cancel the 4K Photo functions

Press [**4K**] (☺) (▼), and then select [**□**] ([Single]) or [**OFF**].



- When you perform [Light Composition] or [Sequence Composition], we recommend using a tripod or the shutter remote control function (→389).

- **Taking pictures of yourself (4K Selfie)**



You can switch to 4K Photo Mode and take pictures of yourself. (→87)

In Self Shot Mode, you can take pictures with [4K Burst (Wide-angle)], a setting that allows you to include a wider background. (In modes other than Self Shot Mode, the setting will switch to [4K Burst].)



- Setting ranges become the following with 4K photo recording:
 - Shutter speed: 1/30 to 1/16000
 - [Min. Shtr Speed]: [1/1000] to [1/30]
 - Exposure compensation: ±3 EV
- The file save method differs depending on the type of card.
 - SDHC memory card:
 - A new file will be created to continue recording if the file size exceeds 4 GB.
 - SDXC memory card:
 - Files are not divided for recording.
- When recording, the angle of view becomes narrower. (Except when recording with [4K Burst (Wide-angle)])
- When recording 4K photos, the following functions are not available:
 - [Destination] ([Travel Date])
 - [Simultaneous Record w/o Filter] (→111, 225)
 - HDMI output
- When recording using the [4K Pre-Burst] function, Step Zoom does not operate.
- Scene Detection in [**iA**] / [**iA⁺**] mode works the same way as when recording video.
- When [4K Pre-Burst] or [Pre-Burst Recording] is set, the battery drains faster and the camera temperature rises. Set these settings only when recording.

- For 4K photo, the menu items below are fixed to the following settings:
 - [Picture Size]:4K (8M)



[4:3]: 3328×2496	[3:2]: 3504×2336
[16:9]: 3840×2160	[1:1]: 2880×2880
 - [Shutter Type]: [ESHTR]
 - [Quality]: 
- With 4K photo recording, the following functions are not available:
 - [AFF] ([Focus Mode])
 - Flash
 - [Bracket]
 - Program Shift
 -  ([AF Mode])
 - [MF Assist] ([4K Pre-Burst] only)
- When you record in an extremely bright location or under lighting such as fluorescent or LED lighting, the coloring or brightness of the image may change or horizontal stripes may appear on the screen. Lowering the shutter speed may reduce the effect of horizontal stripes.
- 4K photo recording does not work while you are using the following functions:
 - [Glistening Water], [Artistic Nightscape], [Glittering Illuminations], [Handheld Night Shot], [Clear Night Portrait], [Soft Image of a Flower] ([SCN] mode)
 - [Rough Monochrome], [Silky Monochrome], [Miniature Effect], [Soft Focus], [Star Filter], [Sunshine] ( mode)
 - [Time Lapse Shot]
 - [Stop Motion Animation]
 - [Live View Composite]
 - [Multi Exp.]

Selecting Pictures from a 4K Burst File

You can select pictures from the 4K burst files and save them.



- When continuing to select pictures from the Auto Review after recording 4K photos, start the operation from either Step 2 or 3.

1 Select a 4K burst file on the playback screen. (→270)

- Select an image with the  icon and then press ▲.
- You can also perform the same operation by touching .
- If the images were recorded with [4K Pre-Burst], proceed to Step 3.



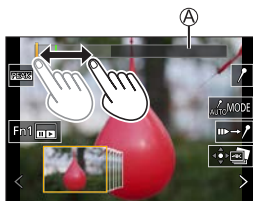

2 Roughly select the scene.

- Drag the slide bar .
- For information about how to use the picture selection slide view screen, refer to page 170.
- If the images were recorded with [4K Burst] or [4K Burst(S/S)], touching  allows you to select the scene in the 4K burst playback screen. (→172)



Picture selection slide view screen

3 Select the frame to save.

- Drag the picture selection slide view .
- You can also perform the same operation by pressing ◀▶.
- To continuously rewind or forward frame-by-frame, touch and hold [/▶].



4 Save the picture.

- Touch [].
- A confirmation screen appears.

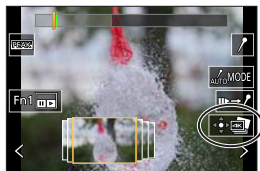

- The picture is saved in JPEG format.
- The recording information (Exif information), such as the shutter speed, aperture, and ISO sensitivity, is also saved with the picture that is saved.

Picture Selection Operations

❖ Picture Selection Slide View Screen Operations

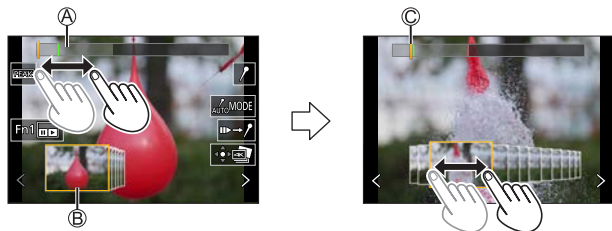

- Ⓐ Slide bar
- Ⓑ Picture selection slide view
- Ⓒ Position of displayed frame

Button operation	Touch operation	Description of operation
◀▶ / 🌞	Drag/ < >	Selects a frame. • To change the frames displayed in the picture selection slide view, select the frame at the left/right end and then touch [<] or [>].
◀▶ Press and hold	< > Touch and hold	Continuously rewinds or forwards frame-by-frame.
—	📏 Touch/drag	Selects the frame to display.
—	Pinch out/ pinch in	Enlarges or reduces the display in small steps.
⚙️	—	Enlarges or reduces the display.
🌞	—	Selects a frame while maintaining the enlarged display (during enlarged display).

	Drag	Moves the enlarged display position (during enlarged display).
—		Switches a marker to be displayed.
[Fn1]		Displays the 4K burst playback screen.
—		Switches to marker operation.
—		Adds or deletes a marker (white marker).
—		Displays the in-focus portion highlighted with color ([Peaking]). <ul style="list-style-type: none"> Switches in order of [PEAK OFF] → [PEAK L] ([LOW]) → [PEAK H] ([HIGH]).
		Saves the picture.

- During marker operation, you can skip to set markers or the beginning or end of the 4K burst file. Touch [] to return to the previous operation.

Button operation	Touch operation	Description of operation
		Moves to the next marker.
		Moves to the previous marker.





❖ 4K burst playback screen









While paused



During continuous playback

Button operation	Touch operation	Description of operation
▲	▶ /	Performs continuous playback or pauses (during continuous playback).
▼	◀ /	Performs continuous rewind playback or pauses (during continuous rewind playback).
▶ / 🌞	▶▶ /	Performs fast-forward playback or performs frame-by-frame forwarding (while paused).
◀ / 🌞	◀◀ /	Performs fast-rewind playback or performs frame-by-frame rewinding (while paused).
—	 Touch/drag	Selects the frame to display (while paused).
—	Pinch out/ pinch in	Enlarges or reduces the display in small steps (while paused).
⚙️	—	Enlarges or reduces the display (while paused).
🌞	—	Selects a frame while maintaining the enlarged display (during enlarged display).
▲▼◀▶	Drag	Moves the enlarged display position (during enlarged display).
—		Switches a marker to be displayed.
[Fn1]		Displays the picture selection slide view screen (while paused).
—		Switches to marker operation.

—	 / 	Adds or deletes a marker (white marker).
—		Displays the in-focus portion highlighted with color ([Peaking]). • Switches in order of [PEAK OFF] → [PEAK L] ([LOW]) → [PEAK H] ([HIGH]).
		Saves the picture (while paused).

- During marker operation, you can skip to set markers or the beginning or end of the 4K burst file. Touch [] to return to the previous operation.

Button operation	Touch operation	Description of operation
	—	Moves to the next marker.
	—	Moves to the previous marker.



- To select and save pictures from a 4K burst file on a PC, use the “PHOTOfunSTUDIO” software. However, it is not possible to treat 4K burst files as videos in “PHOTOfunSTUDIO”.

❖ Auto Marking function

The camera automatically sets markers on scenes in which a face or the movement of a subject is detected. (Green marker)
(Example: At the scene when a vehicle passes by, a balloon bursts, or a person turns around)

- Up to 10 markers are displayed for each file.

Ⓐ Markers set manually

Ⓑ Markers set by the Auto Marking function

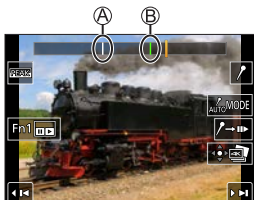

Switches a marker to be displayed

Touch **[AUTO MODE]** on the slide view screen, 4K burst playback screen, or marker operation screen.







[Auto]	Displays a marker on a scene in which a face or the movement of a subject is detected.
[Face Priority]	Displays a marker with preference given to a scene in which a face is detected.
[Motion Priority]	Displays a marker with preference given to a scene in which the movement of a subject is detected.
[Off]	Displays manually set markers only.



- You cannot delete markers set by the Auto Marking function.
- Markers may not be set by the Auto Marking function depending on the recording conditions and the status of subjects.
- In the following cases, markers set by the Auto Marking function are not displayed.
 - 4K burst files recorded with [4K Pre-Burst]

❖ [4K PHOTO Bulk Saving]

You can save any 5 second period of pictures from a 4K burst file all at once.

- 1 Select [4K PHOTO Bulk Saving].
 -  →  → [4K PHOTO Bulk Saving]
- 2 Press   to select a 4K burst file and then press .
 - If the burst time is 5 seconds or less, all frames are saved as pictures.
- 3 Select the first frame of the pictures to be saved all at once and then press .
 - The pictures are saved as a group of burst pictures in JPEG format.

Post-Focus Recording



Taking burst pictures with the same image quality as 4K photos while automatically changing the focus point.

You can select the focus point for the picture to save after recording. Also Focus Stacking lets you combine images with multiple focus points. This function is suitable for subjects that do not move.



Perform burst 4K photo recording while automatically shifting the focus.

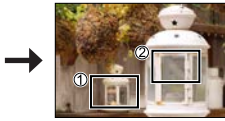

Touch the desired focus point.



A picture with the desired focus point is made.



- Use a UHS Speed Class 3 or higher card when recording.
- The angle of view during recording becomes narrower.
- If you are going to perform Focus Stacking after recording, we recommend using a tripod during recording.
- If the camera temperature rises, [△] may be displayed and recording may stop. Wait until the camera cools down.

1 Press [4K] (▼).

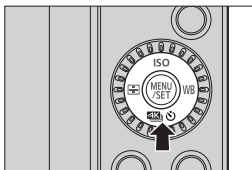

2 Press ◀▶ to select [Post Focus] and press .

- You can also select by rotating .

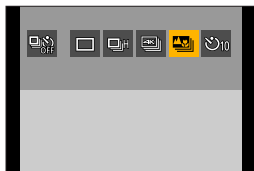

3 Decide on the composition and then adjust the focus.

- Press the shutter button halfway.
- AF detects the focus point on the screen. (Excluding the edges of the screen)
- If no areas on the screen can be brought into focus, the focus indication  blinks and recording is not possible.
- Maintain the same distance to the subject and the same composition until recording finishes.

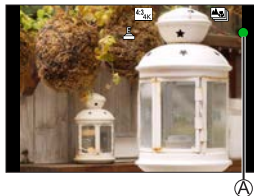

4 Start recording.

- Press the shutter button fully.

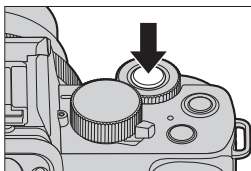

- Recording is performed while automatically changing the focus point. When the icon **B** disappears, recording ends automatically.
- Audio will not be recorded.
- In default settings, Auto Review operates, and a screen that lets you select the focus point will be displayed. (→179)

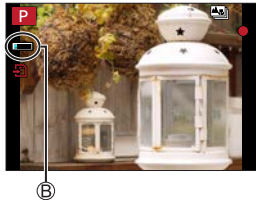

❖ How To Cancel [Post Focus]



Press [**4K**] (☺) (▼), and then select [] ([Single]) or [OFF].



- Since recording is performed with the same image quality as 4K photos, limitations apply to recording functions and menus.
- Focus settings cannot be changed during Post-Focus recording.
- [Digital Zoom] is not available.
- When the following functions are being used, [Post Focus] is not available:
 - Self Shot Mode
 - [Glistening Water], [Artistic Nightscape], [Glittering Illuminations], [Handheld Night Shot], [Clear Night Portrait], [Soft Image of a Flower] ([SCN] mode)
 - [Rough Monochrome], [Silky Monochrome], [Miniature Effect], [Soft Focus], [Star Filter], [Sunshine] ([☺] mode)
 - [Time Lapse Shot]
 - [Stop Motion Animation]
 - [Live View Composite]
 - [Multi Exp.]

Selecting the Focus Point for the Picture to Save

1 Select a Post-Focus image on the playback screen. (→270)

- Select an image with the  icon and then press .
- You can also perform the same operation by touching the  icon.



2 Touch the focus point.



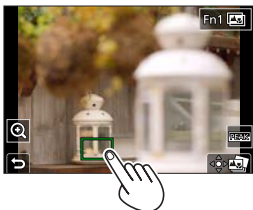





- When the point is in focus, a green frame appears.
- If there is no picture with the selected point in focus, a red frame appears. A picture cannot be saved.
- The edge of the screen cannot be selected.

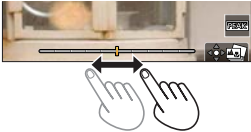

3 Save the picture.

- Touch .
- The picture is saved in JPEG format.

❖ Focus Point Selection Operations

Button operation	Touch operation	Description of operation
▲ ▼ ◀ ▶ / ☀	Touch	Selects a focus position. • Selection is not possible during enlarged display.
		Enlarges the display. • During enlarged display, you can fine-adjust the focus by dragging the slide bar. (You can also perform the same operation by pressing ◀ ▶.) 
		Reduces the display (during enlarged display).
[Fn1]		Switches to Focus Stacking operation. (→ 181)
—		Displays the in-focus portion highlighted with color ([Peaking]). • Switches in order of [PEAK OFF] → [PEAK L] ([LOW]) → [PEAK H] ([HIGH]).
		Saves the picture.



- You cannot display an image on a TV screen and then select the focus point.

Focus Stacking

By merging multiple focus points, you can save pictures that are focused from the foreground through to the background.

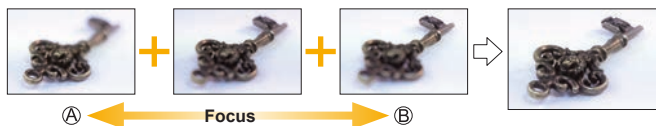

Ⓐ Focus: closer

Ⓑ Focus: more distant

1 On the screen for selecting the focus point in Step 2 on page 179, touch .

- You can also perform the same operation by pressing [Fn1].



2 Select the merging method.

[Auto Merging]	Automatically selects pictures suitable for merging and then merges them into a single picture.
[Range Merging]	Merges pictures with selected focus points into a single picture.

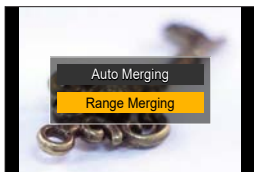

3 (When [Range Merging] is selected)

Touch the focus points.



- Select at least two points.
Selected points are indicated with a green frame.
- The in-focus range between the two selected points is displayed in green.
- Ranges that cannot be selected are displayed in gray.
- To cancel the selection, touch a point with a green frame again.
- To select consecutive points, drag the screen.

4 Save the picture.

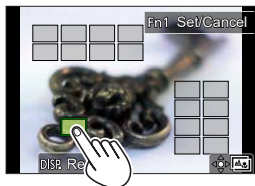
- Touch [].



❖ Operations when [Range Merging] Is Selected

Button operation	Touch operation	Description of operation
	Touch	Selects a point.
[Fn1]	[Set/Cancel]	Sets or cancels a point.
[DISP.]	[All]	Selects all points. (Before selecting points)
	[Reset]	Cancels all selections. (After selecting points)
		Merges the pictures and saves the resulting picture.



- The picture is saved in JPEG format, and the recording information (Exif information), such as the shutter speed, aperture, and ISO sensitivity, of the picture with the closest point is also saved with the picture that is saved.
- Image misalignment due to camera shake will be adjusted automatically. If adjustments are made, the angle of view will become slightly narrower when the pictures are merged.
- If the subject moves during recording or the distance between subjects is great, merging may create an unnatural picture.

Recording Using the Self-timer



1 Press [4K] (▼).

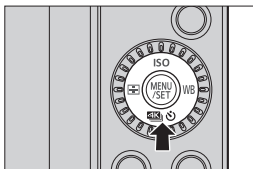

2 Press ◀▶ to select [Self Timer] and press ▲.

- You can also select by rotating .

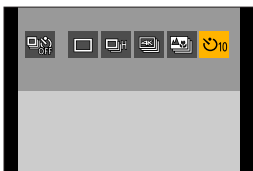

3 Set the Self-Timer time.

- Press ◀▶ to select the Self-Timer time and press .
- You can also select by rotating  or .
- It can also be set using [Self Timer] in the [Rec] or [Motion Picture] menu.

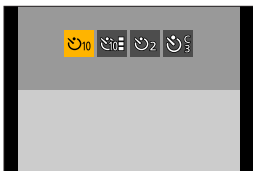

4 Decide on the composition and then adjust the focus.



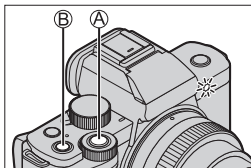

- Press the shutter button halfway.
- The focus and exposure are fixed when the shutter button is pressed halfway.

5 Start recording.





- Press the shutter button **A** or video rec. button **B**.
- The self-timer light blinks and then the shutter is released.



❖ Setting item (Self-timer)

	Takes a picture after 10 seconds.
	Takes 3 pictures at approx. 2 second intervals after 10 seconds. (When recording video, it will be the same operation with [].)
	Takes a picture after 2 seconds. • This setting is a convenient way to avoid camera shake caused by pressing the shutter button.
 (Custom)	It will record after the number of seconds registered in [SET] of [Self Timer] under the [Rec]/[Motion Picture] menu. (→ 322 , 329)

❖ How To Cancel [Self Timer]

Press [] [] (▼), and then select [] ([Single]) or [].



- We recommend using a tripod when recording with the self-timer.



- When the following functions are being used, [] is not available:
 - [Simultaneous Record w/o Filter] (→ [111](#), [225](#))
 - [Bracket]
 - [Multi Exp.]
 - [Live View Composite]
- The self-timer does not work while you are using the following functions:
 - Self Shot Mode (When taking pictures in Self Shot Mode, you can set the Self-timer in [Countdown] (→ [85](#)))
 - [Time Lapse Shot]
 - [Stop Motion Animation] (when [Auto Shooting] is set)

Recording with Time Lapse Shot



Pictures are taken automatically at a set recording interval.

This feature is ideal for keeping track of changes over time in subjects such as animals and plants.

The pictures taken will be saved as a set of group images that can also be combined into a video.



- Check that the clock is set correctly. (→45)
- For long recording intervals, we recommend setting [Lens Position Resume] to [ON] in the [Custom] ([Lens / Others]) menu.

1 Set the camera to [Time Lapse Shot].

- → → [Time Lapse Shot]



2 Set the recording settings.

[Shooting Interval Setting]	[ON]	Sets the interval before the next recording takes place.
	[OFF]	Takes pictures without leaving recording intervals.
[Start Time]	[Now]	Starts recording when the shutter button is pressed fully.
	[Start Time Set]	Starts recording at the set time.
[Image Count]/ [Shooting Interval]	Sets the number of pictures and the recording interval to be taken. <ul style="list-style-type: none"> • [Shooting Interval] is not available when [Shooting Interval Setting] is set to [OFF]. 	

3 Press **▲** to select [Start] and press **MENU/SET**.

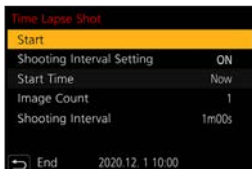

4 Focus on the subject and take a picture.

- The recording starts by fully-pressing the shutter button.
- When [Start Time Set] is set, the camera will enter into sleep status until the start time is reached.
- During recording standby, the camera enters into sleep status when no operation is performed for a certain period of time.
- The recording will stop automatically.

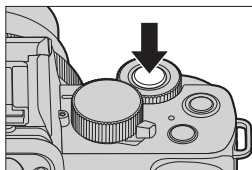

5 Create a video. (→193)

- After the recording has stopped, select [Yes] on the confirmation screen to proceed to create a video. Even if you select [No], you can still create a video with [Time Lapse Video] in the [Playback] menu. (→368)

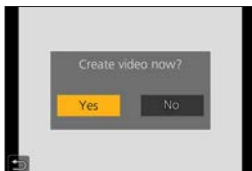

❖ Operations during Time Lapse Shot Recording

Pressing the shutter button halfway during sleep status will turn on the camera.

- You can perform the following operations by pressing [Fn2] during Time Lapse Shot recording.

[Continue]	Returns to the recording. (Only during recording)
[Pause]	Pauses the recording. (Only during recording)
[Resume]	Resumes the recording. (Only while paused) <ul style="list-style-type: none"> • You can also press the shutter button to resume.
[End]	Stops the Time Lapse Shot recording.



- The camera gives priority to achieving the correct exposure, so it may not take pictures at the set interval or take the set number of pictures. Furthermore, it may not end at the end time displayed on the screen.
- Time Lapse Shot is paused in the following cases.
 - When the charge on the battery runs out
 - When you set the camera on/off switch to [OFF]
 - You can set the camera on/off switch to [OFF] and replace the battery or card.
 - Set the camera on/off switch to [ON] and then press the shutter button fully to resume recording.
 - (Note that the images recorded after replacing the card will be saved as a separate set of group images.)
- [Time Lapse Shot] is not available when using the following functions:
 - [Handheld Night Shot] ([SCN] mode)
 - Self Shot Mode
 - [Stop Motion Animation]
 - [Live View Composite]
 - [Multi Exp.]

Recording with Stop Motion Animation



Take pictures while moving the subject little by little.

The pictures taken will be saved as a set of group images that can be combined into a stop motion video.

1 Set the camera to [Stop Motion Animation].

- → → [Stop Motion Animation]



2 Set the recording settings.

[Auto Shooting]	[ON]	Takes pictures automatically at a set recording interval.
	[OFF]	This is for taking pictures manually, frame by frame.
[Shooting Interval]	Sets the recording interval for [Auto Shooting].	

3 Press to select [Start] and press .

4 Press to select [New] and press .



5 Focus on the subject and take a picture.

- Take pictures repeatedly while moving the subject little by little.
- The recording screen displays up to two pictures taken previously. Use them as reference for the amount of movement.
- You can play back the recorded stop motion images by pressing [▶] during recording.
Press [⏏] to delete unnecessary images.
To return to the recording screen, press [▶] again.



6 Stop recording.

- Press **MENU/SET** and then select [Stop Motion Animation] from the [Rec] menu to stop recording.

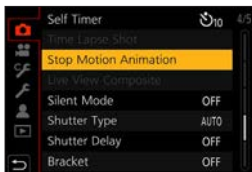

7 Create a video. (→193)

- After the recording has stopped, select [Yes] on the confirmation screen to proceed to create a video.
Even if you select [No], you can still create a video with [Stop Motion Video] in the [Playback] menu. (→368)





- When you select [Additional] in step **4**, group pictures recorded using [Stop Motion Animation] are displayed. Select an image and proceed to Step **5**.



- Up to 9999 frames can be recorded.
- If the camera is turned off while recording, a message for resuming the recording is displayed when it is turned on. Selecting [Yes] allows you to continue the recording from the interruption point.
- The camera gives priority to achieving the correct exposure, so it may not take pictures at the set interval when the flash, etc. is used for recording.
- A picture cannot be selected from [Add to Picture Group] when it is the only one that was taken.
- [Stop Motion Animation] is not available when using the following functions:
 - Self Shot Mode
 - [Time Lapse Shot]
 - [Live View Composite]
 - [Multi Exp.]
- When the following function is being used, [Auto Shooting] in [Stop Motion Animation] is not available:
 - [Handheld Night Shot] ([SCN] mode)

Time Lapse Shot/Stop Motion Animation Videos

After performing Time Lapse Shot or Stop Motion Animation recording, you can proceed to create a video.

- Refer to the sections below about these recording functions.
 - Time Lapse Shot recording: → 187
 - Stop Motion Animation recording: → 190
- You can also create videos with [Time Lapse Video] (→ 368) or [Stop Motion Video] (→ 368) in the [Playback] menu.

1 Select [Yes] on the confirmation screen that appears after recording.

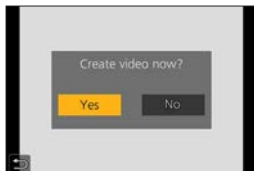

2 Set the options for creating a video.

3 Select [OK].



[OK]	Creates a video.	
[Rec Quality]	Sets the video image quality.	
[Frame Rate]	Sets the number of frames per second. The larger the number is, the smoother the video will be.	
[Sequence]	[NORMAL]	Splices pictures together in recording order.
	[REVERSE]	Splices pictures together in reverse recording order.



- Videos cannot be created if the recording time exceeds 29 minutes and 59 seconds.
- In the following cases, videos cannot be created if the file size exceeds 4 GB:
 - When an SDHC memory card is being used and a 4K [Rec Quality] is set
 - When [Rec Quality] is set to FHD or HD

Bracket Recording



When the shutter button is pressed, the camera can record multiple images while automatically changing the setting value for exposure, aperture, focus or white balance.



• Aperture Bracket can be selected in the following modes:

- [A] mode
- [M] mode (when ISO sensitivity is set to [AUTO])

1 Set [Bracket Type].

- MENU/SET → [CAMERA] → [Bracket] → [Bracket Type]



2 Set [More Settings].

- For information about [More Settings], refer to page for each bracketing method.

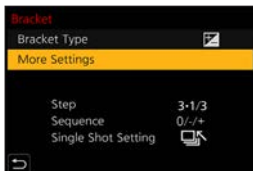



3 Close the menu.

- Press the shutter button halfway.

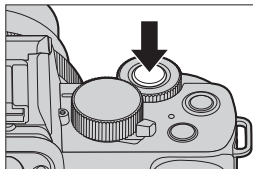
4 Focus on the subject and then take pictures.







❖ Setting Items ([Bracket Type])

 Exposure Bracket	When the shutter button is pressed, the camera records while changing the exposure. (→198)
 Aperture Bracket	When the shutter button is pressed, the camera records while changing the aperture value. (→198)
FOCUS Focus Bracket	When the shutter button is pressed, the camera records while changing the focus point. (→199)
WB White Balance Bracket	When the shutter button is pressed once, the camera automatically records three images with the different white balance adjustment values. (→200)
[OFF]	—

❖ How to Cancel Bracketing

Select [OFF] in Step 1.



- Bracket recording is not available while you are using the following functions:
 - Self Shot Mode
 - [Glistening Water], [Glittering Illuminations], [Handheld Night Shot], [Soft Image of a Flower] ([SCN] mode)
 - [Rough Monochrome], [Silky Monochrome], [Miniature Effect], [Soft Focus], [Star Filter], [Sunshine] ([] mode)
 - [4K PHOTO], [Post Focus]
 - [Time Lapse Shot]
 - [Stop Motion Animation] (when [Auto Shooting] is set)
 - [Live View Composite]
 - [Multi Exp.]
- Exposure Bracket, Aperture Bracket, and Focus Bracket are unavailable when recording with the flash. Aperture Bracket and Focus Bracket can be used when recording with an external flash.
- When the following functions are being used, White Balance Bracket is not available.
 - [] mode, [] mode
 - [Burst]
 - [RAW , [RAW , [RAW] ([Quality])
 - [Filter Settings]

❖ [More Settings] (Exposure Bracket)

[Step]	Sets the image count and exposure compensation step. [3•1/3] (record 3 images in 1/3 EV steps) to [7•1] (record 7 images in 1 EV steps)
[Sequence]	Sets the order in which images are recorded.
[Single Shot Setting]	<p>[□]: Takes only one image each time the shutter button is pressed.</p> <p>[☐]: Takes all of the set number of images when the shutter button is pressed once.</p> <ul style="list-style-type: none"> The [BKT] icon blinks until all of the set number of pictures is taken.



- When you record images with Exposure Bracket after setting the exposure compensation value, the images recorded are based on the selected exposure compensation value.

❖ [More Settings] (Aperture Bracket)

[Image Count]	<p>[3]/[5]: Records the set number of images while alternately setting the aperture value in the sequence of one before and then one after using the initial aperture value as the reference.</p> <p>[ALL]: Records images using all aperture values.</p>
---------------	---

Example when the initial position is set to F8.0

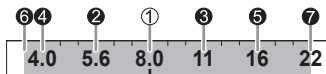

① 1st image, ② 2nd image, ③ 3rd image ... ⑦ 7th image



- The available aperture values vary depending on the lens.

❖ [More Settings] (Focus Bracket)

[Step]	Sets the focus adjustment step. <ul style="list-style-type: none"> The distance that the focus point is moved becomes shorter if the initial focus point is close, and longer if it is far away.
[Image Count]	Sets the image count. <ul style="list-style-type: none"> This cannot be set when taking burst pictures. Burst pictures are taken while the shutter button is pressed.
[Sequence]	<p>[0/-/+]: Records while alternately moving the focus point in the sequence of forward and then backward using the initial focus point as the reference.</p> <p>[0/+]: Records while moving the focus point toward the far side using the initial focus point as the reference.</p>

Example when [Sequence]: [0/-+] is set

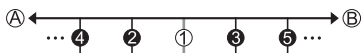

Example when [Sequence]: [0/+] is set



(A) Focus: closer

(B) Focus: more distant

① 1st image, ② 2nd image ... ⑤ 5th image ...



- Pictures recorded with Focus Bracket are displayed as images of one group.
- [Shutter Type] is fixed to [ESHTR].

❖ [More Settings] (White Balance Bracket)

Rotate  or  to set the correction step and then press .

Horizontal direction: [A] - [B]

Vertical direction: [G] - [M]

- The correction step can also be set by touching [] / [] / [] / [].

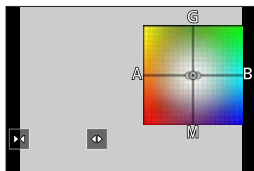

[Silent Mode]



This disables all operation sounds and light output at once.

The audio from the speaker will be muted and the flash and the AF assist light will be set to forced off mode.

- The following settings are fixed:
 - [Flash Mode]: [] (Forced Flash Off)
 - [AF Assist Lamp]: [OFF]
 - [Shutter Type]: [ESHTR]
 - [Beep Volume]: [] (Off)
 - [Shutter Vol.]: [] (Off)

→ [] → Select [Silent Mode]

Settings: [ON]/[OFF]



- Even when [ON] is set, the following functions light/blink:
 - Self-timer light
 - Wireless Connection Lamp
- When [Live View Composite] is being used, [Silent Mode] is not available.
- Use this function at your own responsibility sufficiently considering the privacy, portrait, and other rights of subjects.

[Shutter Type]



Selects the shutter type to use for taking pictures.

→ → Select [Shutter Type]

[AUTO]	Switches the shutter type automatically depending on the recording conditions and shutter speed.
[EFC]	Records with the electronic front curtain type.
[ESHTR]	Records with the electronic shutter type.

	Electronic front curtain type	Electronic shutter type
Mechanism	This type starts exposure electronically and ends it with the mechanical shutter.	This type starts and ends exposure electronically.
Flash	✓	—
Shutter speed (sec.)	[T] (Time, max. approx. 60 seconds)*1, 60 to 1/500	1*2 to 1/16000
Shutter sound	Mechanical shutter sound + Electronic shutter sound*3	Electronic shutter sound*3

*1 This setting is available only in [M] mode.

*2 If the ISO sensitivity is higher than [3200], the shutter speed will be faster than 1 second.

*3 The electronic shutter sound can be set in [Shutter Vol.] and [Shutter Tone] in [Beep] of the [Setup] menu. (→354)



- When [] is displayed on the screen, recording will be with the electronic shutter type.
- When a moving subject is recorded using the electronic shutter, the subject may appear distorted in the picture.
- When you record using the electronic shutter under lighting such as fluorescent or LED lighting, horizontal stripes may be recorded. In such a case, lowering the shutter speed may reduce the effect of horizontal stripes.
- When the following functions are being used, [Shutter Type] is not available:
 - [Live View Composite]
 - [Silent Mode]
 - Focus Bracket ([Bracket])



- To reduce shutter-induced blur, you can set the shutter to release a few seconds after the shutter button is pressed:

[] → [Shutter Delay] (→ [323](#))

Image Stabilizer

The camera detects jitter during recording and automatically corrects it, so you can record images with reduced jitter.



- When using a lens with an O.I.S. switch, set the switch on the lens to ON.
- When you use a lens with no connection function with the camera, [Stabilizer] cannot be selected.
- When you use a lens without the stabilizer function, [Operation Mode] cannot be selected.

Image Stabilizer Settings



Set the image stabilizer operation to match the recording situation.

→ / → Select [Stabilizer]

[Operation Mode]	Sets the stabilization movement (blur) to match the recording method (normal, panning). (→206)	
[E-Stabilization (Video)]	[HIGH]	This will stabilize strong jitter. (Since the stabilizing width is large, the angle of view is narrowed.) • is displayed on the screen during video recording.
	[STANDARD]	This will stabilize jitter. (The angle of view may become narrow.) • is displayed on the screen during video recording.
	[OFF]	This will turn off the electronic stabilization (Video).
<p>Camera shake during video recording is corrected along the vertical, horizontal, roll, pitch, and yaw axes through the combined use of the in-lens and electronic image stabilizers. (5-Axis Hybrid Image Stabilizer)</p> <ul style="list-style-type: none"> • If the recording screen icon is not indicated with or even when Panasonic interchangeable lens that supports Dual I.S.2 is being used, update the lens firmware to the latest version. For the latest information on supported lenses or to download their firmware, refer to our support site. (→20) • When using an interchangeable lens that does not support Dual I.S.2 or when [Operation Mode] is set to [OFF], (Strong) or (Standard) is displayed. 		





- When the shutter button is pressed halfway, the camera shake alert icon  may be displayed on the recording screen. If this is displayed, we recommend using a tripod, the self timer or the shutter remote control function (→389).
- We recommend turning off the image stabilizer function when using a tripod.





- When the following functions are being used, [E-Stabilization (Video)] is not available:
 - [S&Q] mode
 - [Digital Zoom]
 - [4K Live Cropping]

❖ [Operation Mode]

Set the stabilization movement (blur) to match the recording method (normal, panning).

 [Normal]	Corrects vertical, horizontal, and rotational camera shake. This function is suitable for normal recording.
 [Panning]	Corrects vertical camera shake. This is suitable for horizontal panning.
[OFF]	Turns the in-lens image stabilization function OFF.

- The image stabilizers to be activated differ depending on your lens.
- When using lenses with an O.I.S. switch, the camera's operation mode cannot be set to [OFF]. Set the switch on the lens to OFF.
- When the following functions are being used,  ([Panning]) switches to  ([Normal]):
 - Video recording, [4K PHOTO], [Post Focus]



8. Brightness (Exposure)/ Coloring/Picture effect

[Metering Mode]



Type of optical measurement to measure brightness can be changed.

MENU SET → [Camera]/[Video] → Select [Metering Mode]

 Multi-metering	Method in which the most suitable exposure is measured by judging the allocation of brightness on the whole screen.
 Center-weighted	Method used to perform measuring which focuses on the center of the screen.
 Spot	Method used to measure the extremely small part around the spot-metering target (A). <ul style="list-style-type: none">• When you move the AF area, the spot metering target also moves to match.

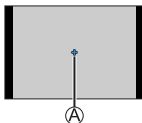

Exposure Compensation



You can compensate the exposure when the correct exposure determined by the camera is too bright or too dark.

You can adjust the exposure in 1/3 EV steps in a range of ± 5 EV.

When recording videos or recording with 4K photo or Post-Focus, the range changes to ± 3 EV.

1 Press [Fn].

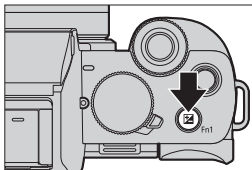

2 Compensate the exposure.

- Rotate or .

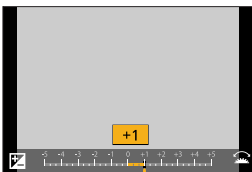

3 Confirm your selection.

- Press the shutter button halfway.

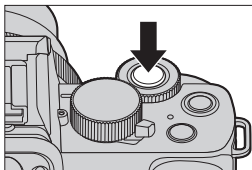



- In [M] mode, you can compensate the exposure by setting the ISO sensitivity to [AUTO].
- When the exposure compensation value falls below or exceeds ± 3 EV, the brightness of the recording screen will no longer change.
Press the shutter button halfway or use AE Lock to reflect the value on the recording screen.
- The set exposure compensation value is stored even if you turn off the camera.



- You can set the exposure compensation value to be reset when the camera is turned off:
[] \Rightarrow [] \Rightarrow [Exposure Comp. Reset] (\Rightarrow 331)
- Exposure Bracket can be set and flash output can be adjusted on the exposure compensation screen:
[] \Rightarrow [] \Rightarrow [Exposure Comp. Disp. Setting] (\Rightarrow 337)

Locking Focus and Exposure (AF/AE Lock)



Lock the focus and exposure in advance to take pictures with the same focus and exposure settings while changing the composition.

This is useful when you want to bring an edge of the screen into focus or there is a backlight, for example.

1 Register [AF/AE LOCK] to the Fn button. (→292)

- These cannot be registered to [Fn5] to [Fn9].

2 Lock focus and exposure.

- Press and hold the Fn button.
- If focus is locked, then the AF lock icon (A) will be displayed.
- If exposure is locked, then the AE lock icon (B) will be displayed.

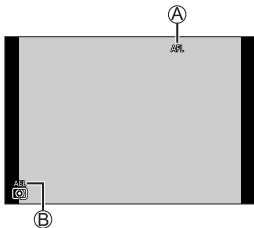

3 Hold the Fn button to decide on the composition and then perform recording.

- Press the shutter button fully.

❖ Setting the function of [AF/AE LOCK]



 →  →  → Select [AF/AE Lock]

[AE LOCK]	The exposure is locked.
[AF LOCK]	The focus is locked.
[AF/AE LOCK]	Both focus and exposure are locked.
[AF-ON]	Auto Focus is activated.



- Program Shift can be set even when AE is locked.



- You can maintain lock even without pressing and holding the Fn button:
 →  → [AF/AE Lock Hold] (→ 331)

ISO Sensitivity



You can set light sensitivity (ISO sensitivity).

With the default settings, you can set 200 to 25600 in 1/3 EV increments.

1 Press [ISO] (▲).

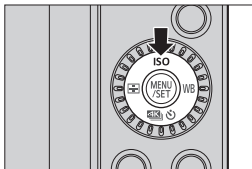

2 Select ISO sensitivity.

- Rotate or .

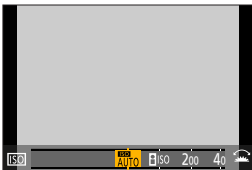

3 Confirm your selection.

- Press the shutter button halfway.

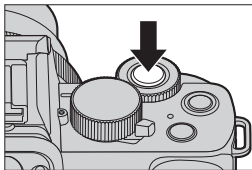

Characteristics of the ISO Sensitivity

By increasing the ISO sensitivity, the shutter speed can be increased in dark places to prevent camera shake and subject blur. However, higher ISO sensitivities also increase the amount of noise in the recorded images.

❖ **Setting Items (ISO Sensitivity)**

[AUTO]	ISO sensitivity is automatically set in a range up to 3200 depending on the brightness of a subject.
[ISO] (Intelligent ISO)	ISO sensitivity is automatically set in a range up to 3200 depending on the movement and brightness of a subject. <ul style="list-style-type: none"> The shutter speed is not fixed when the shutter button is pressed halfway. It is continuously changing to match the movement of the subject until the shutter button is pressed fully.
[200] to [25600]	The ISO sensitivity is fixed at the selected value. <ul style="list-style-type: none"> You can extend the ISO sensitivity lower limit to [100] by setting [Extended ISO] (→331) to [ON] in the [Custom] ([Exposure]) menu.

- When the following functions are being used, **[ISO]** is not available:
 - [S] mode, [M] mode, [P/M] mode, [S&Q] mode
 - [4K PHOTO], [Post Focus]
 - [Live View Composite]
- When the following functions are being used, the ISO sensitivity that can be set is restricted.
 - [P/M] mode, [S&Q] mode, [4K PHOTO], [Post Focus]: [6400] (upper limit)
 - [V-Log L] ([Photo Style]): [400] (lower limit)
 - [Filter Settings]: [3200] (upper limit) (When set to [High Dynamic], the setting is fixed to [AUTO].)
 - [Live View Composite]: [200] (lower limit) (When [Extended ISO] is set to [ON], the setting will be [L.100].), [1600] (upper limit)
 - [Multi Exp.]: [200] (lower limit), [3200] (upper limit)



- During video recording, the camera operates as [AUTO] (for video). (When not in [pCM] / [S&Q] mode)



- You can set upper and lower limits for ISO Auto:
 - [📷] ⇒ [ISO Sensitivity (photo)] (→319)
 - [👤] ⇒ [ISO Sensitivity (video)] (→262)
- You can set the lower limit for shutter speed for ISO Auto:
 - [📷] ⇒ [Min. Shtr Speed] (→319)
- You can change the intervals between ISO sensitivity settings values:
 - [⚙️] ⇒ [📏] ⇒ [ISO Increments] (→331)
- You can set the upper limit for ISO Auto on the ISO sensitivity settings screen:
 - [⚙️] ⇒ [🌄] ⇒ [ISO Displayed Setting] (→337)

White Balance (WB)



White balance (WB) is a function that corrects the color cast produced by the light illuminating the subject.

It corrects the colors so that white objects appear in white to make the overall color closer to what is seen by the eye.

Normally, you can use auto ([AWB], [AWBc] or [AWBw]) to obtain the optimal white balance.

Set this function when the coloring of the image is different from what you expected, or you want to change the coloring to capture the ambience.

1 Press [WB] (▶).

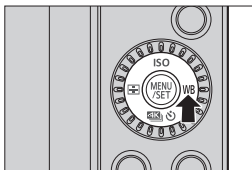

2 Select the white balance.

- Rotate or .



3 Confirm your selection.

- Press the shutter button halfway.

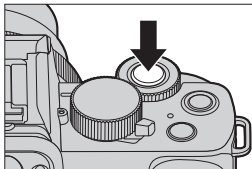

❖ Setting Items (White Balance)



[AWB]	Auto
[AWBc]	Auto (Reduces the reddish hue under an incandescent light source)
[AWBw]	Auto (Leaves the reddish hue under an incandescent light source)
[☀]	Clear sky
[☁]	Cloudy sky
[🏠]	Shade under a clear sky
[💡]	Incandescent light
[⚡WB]*1	Flash
[M1] to [M4]	Set mode 1 to 4 (→218)
[K1] to [K4]	Color temperatures 1 to 4 (→218)

*1 It operates as [AWB] during video recording or when recording with [4K PHOTO] or [Post Focus].

- 1 [AWB] will work within this range.
- 2 Blue sky
- 3 Cloudy sky (Rain)
- 4 Shade
- 5 Sunlight
- 6 White fluorescent light
- 7 Incandescent light bulb
- 8 Sunrise and sunset
- 9 Candlelight

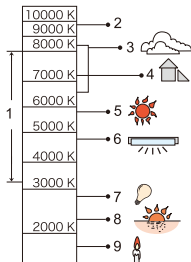
K=Kelvin Color Temperature





- Under lighting such as fluorescent or LED lighting, the appropriate white balance will vary depending on the lighting type. Use [AWB], [AWBc], [AWBw] or [] to [].



- The white balance is fixed to [AWB] while [Filter Settings] is being used.
- The White Balance may not operate correctly if you take pictures using a flash and the subject is recorded outside of the effective flash range.
- In [SCN] mode, settings suitable for each scene are made.
- In [SCN] mode, changing the scene or recording mode will return White Balance settings (including the White Balance fine adjustment setting) back to [AWB].

❖ Registering the White Set ([) to [)

Take pictures of a white object under the light source of the recording location to adjust the white balance until it appears white.



- 1 Press [WB] (▶) and then select any value from [) to [- 2 Press ▲.
- 3 Aim the camera at a white object so that it appears inside the frame at the center of the screen and then press .
 - This will set the white balance and return you to the recording screen.



- After retrieving the image for noise reduction with [Live View Composite], the white set registration cannot be used.

❖ Color Temperature Setting ([) to [

Set the numeric value for the white balance color temperature.

- 1 Press [WB] (▶) and then select any value from [) to [- 2 Press ▲.
- 3 Press ▲ ▼ to select the color temperature and then press .



- You can set a color temperature from [2500K] to [10000K].

Adjusting the White Balance

You can adjust the coloring even when the coloring you want to apply is not produced by the selected white balance.

1 Press [WB] (▶).

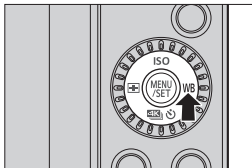

2 Select the white balance and then press ▼.

- The adjustment screen is displayed.



3 Adjust the coloring.

◀: [A] (AMBER: ORANGE)

▲: [G] (GREEN: GREENISH)

▶: [B] (BLUE: BLUISH)

▼: [M] (MAGENTA: REDDISH)

- You can also touch the graph to make adjustments.
- Press [DISP.] to return to the unadjusted state.
- You can set the White Balance Bracket by rotating  or . (→200)

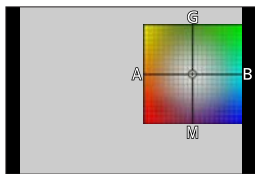

4 Confirm your selection.

- Press the shutter button halfway.

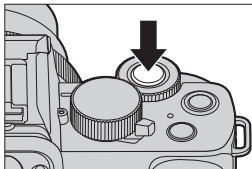

- When the white balance is adjusted, the color of its recording screen icon changes to the adjusted color. Adjusting toward the [G] side will display [+], while adjusting toward the [M] side will display [-].

[Photo Style]



You can select the finishing settings of images to suit your subjects and expression styles.

The image quality can be adjusted for each Photo Style.

→ / → Select [Photo Style]

STD. [Standard]	The standard setting.
VIVID [Vivid]	A setting that produces a more vivid quality with higher saturation and contrast.
NAT [Natural]	A setting that produces a softer quality with lower contrast.
MONO [Monochrome]	A monochrome setting with no color shades.
L.MONO [L.Monochrome]	A black-and-white setting with rich gradation and crisp black accents.
L.MONO D [L.Monochrome D]	A monochrome setting that creates a dynamic impression with enhanced highlights and shadows.
SCNY [Scenery]	A setting suited for sceneries with vivid blue skies and greens.
PORT [Portrait]	A setting suited for portraits with a healthy and beautiful skin tone.
CUST [Custom]	Setting for using colors and picture quality that were registered in advance.
CNED [Cinelike D]	Setting that gives priority to the dynamic range by using a gamma curve designed to create film-like images. Suited for editing.
CNEV [Cinelike V]	Setting that gives priority to the contrast by using a gamma curve designed to create film-like images.
V-Log L [V-Log L]	Gamma curve setting intended for post-production processing. <ul style="list-style-type: none"> • It allows you to add rich gradation to images during post production editing.







- In **[iA⁺]** mode, operation differs from that in other recording modes.
 - [Standard] or [Monochrome] can be set.
 - The setting will be reset to [Standard] when the camera is switched to another recording mode or it is turned off.
 - Image quality cannot be adjusted.
- Only picture quality adjustment can be set in **[SCN]** mode.
- When [Filter Settings] is being used, [Photo Style] is not available.

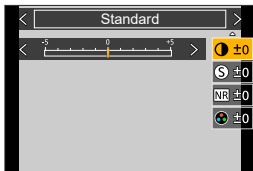

❖ Adjusting Image Quality

- 1 Press ◀▶ to select the type of Photo Style.
- 2 Press ▲▼ to select an item and then press ◀▶ to adjust.
 - You can register adjusted details to [Custom] by pressing [DISP].
- 3 Press .
 - When the image quality is adjusted, the Photo Style icon on the recording screen is indicated with [+].



Settings Items (Image Quality Adjustment)

 [Contrast]*1	Adjusts the contrast in the image.
 [Sharpness]	Adjusts the outlines in the image.
 [Noise Reduction]	Adjusts the noise reduction effect. <ul style="list-style-type: none"> • Increasing the effect may cause a slight drop in picture resolution.
 [Saturation]*2	Adjusts the vividness of colors.
 [Color Tone]*3	Adjusts blue and yellow tints.

 [Filter Effect]**3	[Yellow]	Enhances the contrast. (Effect: weak) Records the sky with a clear blue.
	[Orange]	Enhances the contrast. (Effect: medium) Records the sky with a darker blue.
	[Red]	Enhances the contrast. (Effect: strong) Records the sky with a much darker blue.
	[Green]	Skin and lips of people appear in natural tones. Green leaves appear brighter and more enhanced.
	[Off]	—
 [Grain Effect]**3	[Low]/ [Standard]/ [High]	Sets the grain effect level.
	[Off]	—

*1 Cannot be adjusted when [V-Log L] is selected.

*2 Available when anything other than [Monochrome], [L.Monochrome], [L.Monochrome D] or [V-Log L] is selected.

*3 Available when [Monochrome], [L.Monochrome] or [L.Monochrome D] is selected.



- The effects of [Grain Effect] cannot be checked on the recording screen.
- [Grain Effect] is not available when using the following functions:
 - Video recording, [4K PHOTO], [Post Focus]

[Filter Settings]



This mode records with additional image effects (filters) just like in the [Filter] mode. (→ 111)

You can adjust the effect for each filter.

In addition, you can simultaneously take pictures without effects.

MENU/SET → [Camera]/[Video] → [Filter Settings] → Select [Filter Effect]

Settings: [ON]/[OFF]/[SET]

❖ Setting a Filter with Touch Operation

① Touch [Filter].

② Touch the item to set.

[Filter]: Filter on/off

[EXPS]: Filter

[Filter Effect]: Filter effect adjustment



- When using [Filter Effect], you cannot use menus or recording functions which are not available in [Filter] mode.
- White balance will be fixed to [AWB] and the flash will be fixed to [Flash Off].
- The upper limit to ISO sensitivity is [3200].
- When [High Dynamic] is set, the ISO sensitivity is fixed to [AUTO].
- [Rough Monochrome], [Silky Monochrome], [Soft Focus], [Star Filter] and [Sunshine] are not available during video recording.
- [Filter Effect] is not available when using the following functions:
 - [Live View Composite]
 - [Multi Exp.]
 - [4K Live Cropping]

[Simultaneous Record w/o Filter]



You can simultaneously take pictures with no added filter effects.

→ /[] → [Filter Settings] → Select [Simultaneous Record w/o Filter]

Settings: [ON]/[OFF]



- [Simultaneous Record w/o Filter] is not available when using the following functions:
 - [Burst]
 - [4K PHOTO], [Post Focus]
 - Taking still pictures while a video is being recorded (when [] ([Video Priority]) is set)
 - [Time Lapse Shot]
 - [Stop Motion Animation]
 - [RAW], [RAW], [RAW] ([Quality])
 - [Bracket]

9. Flash

Using a Flash



❖ Open/Close the built-in flash

Ⓐ To open the flash

Ⓑ To close the flash

- The flash setting is fixed to [⚡] (Forced Flash Off) while the flash is closed. (Except when using an external flash)

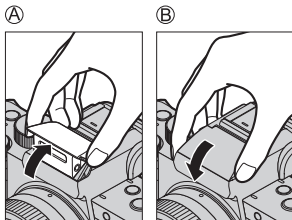

- Be careful not to catch a finger or any other part of your body or any object when you close the flash.
- Forcibly closing the flash can damage the camera.
- Be sure to close the built-in flash when not in use.
- Do not bring any objects near the flash or block the flash. Heat or light may cause the object to deform or discolor.
- Do not block the flash with your hand while it is firing.
- Do not close the flash immediately after the preliminary flash is operated prior to taking pictures for Forced ON/Red-Eye Reduction and other flash settings. If you close the flash immediately, it will cause a malfunction.
- If you record repeatedly, time may be needed to charge the flash. While the flash is charging, images will be recorded without the flash firing.
- When an External Flash is attached, it will have priority over the built-in flash. For information about external flash, refer to (→447).

Setting Flash



You can set the flash function to control flash firing from the camera.

[Flash Mode]

Sets the flash mode.

MENU / **SET** → [CAMERA] → [Flash] → Select [Flash Mode]



<p> Forced Flash On</p> <p> Forced On/Red-Eye</p>	<p>The flash fires every time regardless of the recording conditions.</p> <p>This is suitable for recording when there is backlighting or under lighting such as fluorescent lighting.</p>
<p> Slow Sync.</p> <p> Slow Sync./Red-Eye</p>	<p>When recording images against a nightscape, this will slow the shutter speed when the flash fires to make not only the subject but also the nightscape appear brighter.</p> <ul style="list-style-type: none"> • Slower shutter speeds may result in blurry images. To avoid this, we recommend using a tripod.
<p> Forced Flash Off</p>	<p>The flash does not fire.</p>

- For details about flash settings in [iA] / [iA+] mode, refer to (→78).



- The flash fires twice.

The interval between the first and second firings is longer when [$\downarrow\text{Ⓢ}$] or [$\uparrow\text{Ⓢ}$] is set. The subject should not move until the second firing has finished.

- [$\downarrow\text{Ⓢ}$] and [$\uparrow\text{Ⓢ}$] cannot be used when the following are set:
 - [Flash Synchro]: [2ND]
 - [Wireless]: [ON]
- Some flash modes may not be available depending on the settings on the external flash.
- The effectiveness of red-eye reduction varies from person to person. The effect, which is influenced by factors such as distance to the subject and whether the subject is looking at the camera when the preliminary flash is fired, may not be very noticeable in some cases.

❖ Available Flash Settings by Recording Mode

The available flash settings depend on the recording mode.

(✓: Available, —: Not available)

Recording mode		⚡	⚡Ⓞ	⚡S	⚡SⓄ	Ⓞ
P/A		✓	✓	✓	✓	✓
S/M		✓	✓	—	—	✓
SCN (●: Default settings)	[Clear Portrait]	✓	●	—	—	✓
	[Silky Skin]	✓	●	—	—	✓
	[Sweet Child's Face]	✓	●	—	—	✓
	[Clear Night Portrait]	—	—	—	●	✓
	[Soft Image of a Flower]	●	—	—	—	✓
	[Appetizing Food]	●	—	—	—	✓
	[Cute Dessert]	●	—	—	—	✓
	[Freeze Animal Motion]	●	—	—	—	✓
	[Clear Sports Shot]	●	—	—	—	✓
[Monochrome]	●	✓	✓	✓	✓	



- Flash recording is not possible when the following functions are being used:
 - [Backlit Softness], [Relaxing Tone], [Distinct Scenery], [Bright Blue Sky], [Romantic Sunset Glow], [Vivid Sunset Glow], [Glistening Water], [Clear Nightscape], [Cool Night Sky], [Warm Glowing Nightscape], [Artistic Nightscape], [Glittering Illuminations], [Handheld Night Shot] ([SCN] mode)
 - [4K PHOTO], [Post Focus]
 - [ESHTR]
 - [Silent Mode]
 - [HDR]
 - [Filter Settings]
- [SCN] mode flash setting is returned to the initial value with each change of scene.

❖ Shutter Speeds for Flash Modes

[Flash Mode]	Shutter speed (sec.)
	1/50*1
	1 to 1/50

*1 In [S] mode, the shutter speed will be 60 seconds to 1/50 of a second and in [M] mode it will be [T] (Time) or 60 seconds to 1/50 of a second.

- Shutter speeds faster than 1/50 of a second are not available when you fire the flash.
- In [iA] / [iA+] mode, the shutter speed changes depending on the detected scene.

❖ The available flash range (approximation)

When you use certain lenses, light from the flash may be blocked or fail to cover the lens field of view, causing dark areas to appear in the resulting pictures. Check the distance to the subject when taking a picture.

When the interchangeable lens (H-FS12032) is used	
Wide	Tele
0.4 m (1.3 feet) to 4.1 m (13 feet)	0.3 m (0.98 feet) to 2.5 m (8.2 feet)

- These ranges are obtained, the ISO sensitivity is set to [AUTO], and [ISO Auto Upper Limit (Photo)] in [ISO Sensitivity (photo)] is set to [AUTO].



- When taking pictures with flash with the lens hood attached, the lower portion of the photo may turn dark and the control of the flash may be disabled because the photo flash may be obscured by the lens hood. We recommend detaching the lens hood.

[Flash Adjust.]

Adjusts the flash output if a picture taken using the flash is too bright or too dark.

1 Select [Flash Adjust.].

-  → [CAMERA] → [Flash] → [Flash Adjust.]



2 Press ◀▶ to adjust the flash output and then press .

- It can be adjusted within the range of [-2 EV] to [+2 EV] in 1/3 EV steps.



- When the intensity of the flash is adjusted, [+], or [-] is displayed on the flash icon.
- For information about adjusting the flash output when recording using a wireless flash, refer to page 236.
- [Flash Adjust.] cannot be used when [Wireless] is set to [ON].



[Flash Synchro]

When a moving subject is recorded at night using a slow shutter and flash, a trail of light may appear in front of the subject.

If you set [Flash Synchro] to [2ND], you can take a dynamic picture with a trail of light appearing behind the subject by firing the flash immediately before the shutter closes.

MENU SET → **[CAMERA]** → **[Flash]** → **Select [Flash Synchro]**



[1ST]	This is the normal method for recording with the Flash.	
[2ND]	The light source appears behind the subject and the picture becomes dynamic.	



- When [2ND] is set, [2nd] is displayed on the flash icon of the recording screen.
- When the following functions are being used, [Flash Synchro] is fixed to [1ST]:
 - [Wireless]
 - [Live View Composite]
- The effect may not be adequately achieved at faster shutter speeds.

[Auto Exposure Comp.]



Automatically adjust the flash output in conjunction with the exposure compensation value. (→208)

 →  → **[Flash]** → **Select [Auto Exposure Comp.]**

Settings: [ON]/[OFF]

[Red-Eye Removal]



When [Flash Mode] is set to [] or [], the camera automatically detects red-eye and corrects image data.

 →  → **Select [Red-Eye Removal]**

Settings: [ON]/[OFF]



- When [ON] is set, [] is displayed on the flash icon.
- Red-eye cannot be corrected depending on its appearance.

Recording Using a Wireless Flash



You can use a Flash (DMW-FL580L/DMW-FL360L/DMW-FL200L: optional) to record using a wireless flash.

You can separately control the firing of three flash groups and the flash attached to the hot shoe of the camera.

- The built-in flash does not support wireless flash control.

❖ Placing a Wireless Flash

Place the wireless flash with its wireless sensor facing the camera.

Placement example

When C is placed to erase the shadow in the background of the subject that the flash groups A and B will create

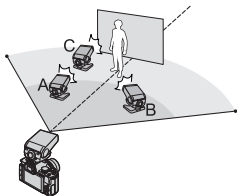

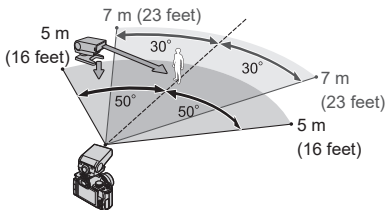

Placement range

When DMW-FL200L is attached



- The placement range serves as a guide for when recording with the camera held horizontally. The range differs depending on the surrounding environment.
- We recommend using a maximum of three wireless flashes in each group.
- If the subject is too close, communication light may affect the exposure. You can reduce the effect by setting [Communication Light] to [LOW] or lowering the output with a diffuser or similar device. (→237)

- 1 Attach an external flash to the camera. (→447)
- 2 Set the wireless flashes to [RC] mode and then place them.
 - Set the channel and group for the wireless flashes.
- 3 Enable the wireless flash function of the camera.
 -  →  → [Flash] → [Wireless] → [ON]

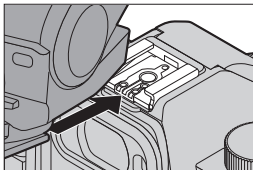

- 4 Set [Wireless Channel].
 - Select the same channel as on the wireless flash side.



- 5 Set [Wireless Setup].
 - Set the firing mode and flash output.

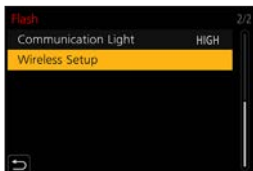

❖ Setting Items ([Wireless Setup])

- To fire a test flash, press [DISP].



[External Flash]	[Firing Mode]	<p>[TTL]: The camera automatically sets the flash output.</p> <p>[AUTO]*1: Sets the flash output on the external flash side.</p> <p>[MANUAL]: Sets the flash output of the external flash manually.</p> <p>[OFF]: The external flash outputs only communication light.</p>
	[Flash Adjust.]	Adjusts the flash output of the external flash manually when [Firing Mode] is set to [TTL].
	[Manual Flash Adjust.]	<p>Sets the flash output of the external flash when [Firing Mode] is set to [MANUAL].</p> <ul style="list-style-type: none"> It can be set within the range of [1/1] (full flash output) to [1/128] in 1/3 steps.
[A Group]/ [B Group]/ [C Group]	[Firing Mode]	<p>[TTL]: The camera automatically sets the flash output.</p> <p>[AUTO]: Sets the flash output on the wireless flash side.</p> <p>[MANUAL]: Sets the flash output of the wireless flash manually.</p> <p>[OFF]: The wireless flashes of the specified group will not fire.</p>
	[Flash Adjust.]	Adjusts the flash output of the wireless flash manually when [Firing Mode] is set to [TTL].
	[Manual Flash Adjust.]	<p>Sets the flash output of the wireless flash when [Firing Mode] is set to [MANUAL].</p> <ul style="list-style-type: none"> It can be set within the range of [1/1] (full flash output) to [1/128] in 1/3 steps.

*1 This cannot be set when using the Flash (DMW-FL200L: optional).

❖ [Communication Light]

Set the strength of communication light.

 →  → [Flash] → Select [Communication Light]

Settings: [HIGH]/[STANDARD]/[LOW]

10. Recording Videos

Recording Videos



1 Start recording.

- Press the video rec. button.
- Release the video rec. button right after you press it.

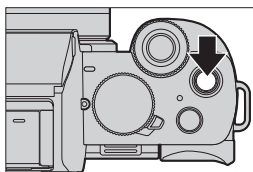

- (A) Red REC frame indicator (→ 346)
- (B) Recording state indicator
- (C) Remaining recording time
- (D) Elapsed recording time



2 Stop recording.

- Press the video rec. button again.



- If maintaining focus on the subject is difficult during video recording with AF, press the shutter button halfway to re-adjust the focus.

❖ [Rec Quality]



Sets the image quality of videos to be recorded.

⇒ ⇒ Select [Rec Quality]

[Rec Quality]	Picture size	Recording frame rate	Sensor output	Bit rate
[4K/100M/30p]*1	3840×2160	30p	30 fps	100 Mbps
[4K/100M/24p]*1	3840×2160	24p	24 fps	100 Mbps
[FHD/28M/60p]	1920×1080	60p	60 fps	28 Mbps
[FHD/20M/30p]	1920×1080	30p	30 fps	20 Mbps
[FHD/24M/24p]	1920×1080	24p	24 fps	24 Mbps
[HD/10M/30p]	1280×720	30p	30 fps	10 Mbps

*1 4K video



- The amount of time you can record in a single session varies depending on [Rec Quality].

When the recording time of a single session exceeds the following duration, recording stops.

- [4K/100M/30p] / [4K/100M/24p]: 10 minutes
- [FHD/28M/60p]: 20 minutes
- [FHD/20M/30p] / [FHD/24M/24p] / [HD/10M/30p]: 29 minutes and 59 seconds



- Since the camera employs the VBR recording format, the bit rate is changed automatically depending on the subject to record. As a result, video recording time is shortened when a fast-moving subject is recorded.
- When the following functions are being used, 4K video cannot be set.
 - [Miniature Effect] ([] mode)
 - HDMI output
- To record 4K videos, use a UHS Speed Class 3 card.
- When you record 4K videos, the angle of view will be narrower than videos of other sizes.
- To ensure highly accurate focus, 4K videos are recorded at reduced Auto Focus speeds. It may be difficult to focus on the subject with Auto Focus, but this is not a malfunction.



❖ Size Interval for Dividing Files

[Rec Quality]	[4K]	<p>When using an SDHC memory card: A new file will be created to continue recording if the file size exceeds 4 GB.</p> <p>When using an SDXC memory card: Even if the file size exceeds 4 GB, a single file will be recorded.</p>
	[FHD]/[HD]	A new file will be created to continue recording if the file size exceeds 4 GB.







- If an operation such as a zoom or button operation is performed during video recording, that operation sound may be recorded.
- The lens operation sound (AF and image stabilizer) may be recorded to video.
- If the operation sound of pressing the video rec. button to end recording bothers you, try the following:
 - Record the video about 3 seconds longer, and then divide the last part of the video using [Video Divide] in the [Playback] menu.
 - Use the shutter remote control function (➔ [389](#)) for recording.
- Depending on the type of card, the card access indication may appear for a while after video recording. This is not a malfunction.



- Even when playback is performed on a supported device, situations may occur where image or sound quality is poor, recording information is not displayed correctly, or playback is not possible, for example. If you experience any of these, play them back on the camera.
- If the camera temperature rises, [] may be displayed and recording may stop. Wait until the camera cools down.
- When the following functions are being used, the recording mode during video recording is set to “Low Light Mode”:
 - [Clear Nightscape], [Artistic Nightscape], [Handheld Night Shot], [Clear Night Portrait] ([SCN] mode)
- During video recording, it will not be outputted via HDMI.
- Video recording is not possible while you are using the following functions:
 - [Glistening Water], [Glittering Illuminations], [Soft Image of a Flower] ([SCN] mode)
 - [Rough Monochrome], [Silky Monochrome], [Soft Focus], [Star Filter], [Sunshine] ([] mode)
 - [Post Focus]
 - [Time Lapse Shot]
 - [Stop Motion Animation]
 - [Live View Composite]



- You can display the frame on the recording screen that indicates the angle of view that will be achieved with trimming (cropping) in post-processing: [] ⇒ [] ⇒ [Frame Marker] (→268)
- It can be indicated as the angle of view when recording video: [] ⇒ [] ⇒ [Rec Area] (→346)

Taking pictures while a video is being recorded



Press the shutter button fully during the video recording.



- Simultaneous recording indicator is displayed while recording pictures.
- Recording with the Touch Shutter function is also available.



❖ Setting the video priority or picture priority mode



→ → Select [Picture Mode in Rec.]

 [Video Priority]	<ul style="list-style-type: none"> • Pictures will be recorded with a picture size determined by the [Rec Quality] setting for videos. • Only JPEG images are recorded when [Quality] is set to [RAW], [RAW], or [RAW]. (When set to [RAW], still pictures will be recorded in [Quality] of [RAW].) • Up to 40 still pictures can be recorded during the recording of a video. (A video with a [Rec Quality] size of [4K]: up to 10 pictures)
 [Photo Priority]	<ul style="list-style-type: none"> • Pictures will be recorded with the set [Quality] and image size of [Picture Size]. • The screen will go dark while recording pictures. A still picture will be recorded in the video during that period, and audio is not recorded. • Up to 10 still pictures can be recorded during recording of the video. (A video with a [Rec Quality] size of [4K]: up to 5 pictures)



- The aspect ratio of a still picture is fixed to [16:9].
- When the following functions are in use, simultaneous recording is not available.
 - Videos with the frame rate under [Rec Quality] set to [24p] (when ([Photo Priority]) is set)
 - [4K PHOTO] (when ([Photo Priority]) is set)
 - [Ex. Tele Conv.] ([Motion Picture]) (when ([Photo Priority]) is set)
 - [Snap Movie]

Creative Video Mode



It is possible to manually change the aperture, shutter speed and ISO sensitivity and record videos.

1 Set the mode dial to [M].

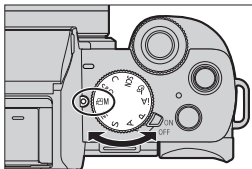

2 Set the exposure mode.

- → [M] → [Exposure Mode] → [P]/[A]/[S]/[M]
- You can perform the same exposure operations as the [P]/[A]/[S]/[M] modes.
- Program Shift does not work.



3 Close the menu.

- Press the shutter button halfway.

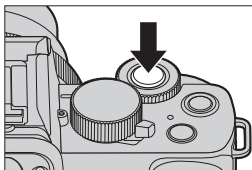

4 Start recording.

- Press the shutter button **A** or video rec. button **B**.

5 Stop recording.

- Press the shutter button or video rec. button again.

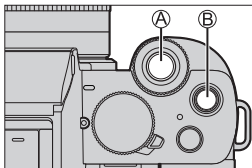

- It is also possible to display the selection screen by touching the recording mode icon in recording screen.





❖ Operations During Video Recording

Change the exposure and audio settings with touch operation to prevent operation sounds from being recorded.

① Touch [].

② Touch an icon.

	Zoom (When using an interchangeable lens supporting power zoom)
F	Aperture value
SS	Shutter speed

	Exposure compensation
ISO	ISO sensitivity
	Sound recording level adjustment (When [Sound Rec Level Adj.] is set to [MANUAL].)

③ Drag the slide bar to set the item.

[▼]/[▲]: Changes the setting slowly.

[⏏]/[⏏]: Changes the setting quickly.

- If you touch icon , the screen of Step ② is redisplayed.

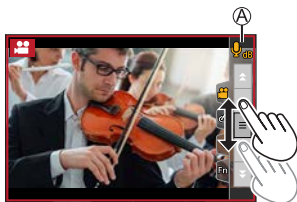

[4K Live Cropping]

By cropping a part of the image from the image displayed in the live view, it is possible to record FHD video that incorporates panning and zooming with the camera staying in a fixed position.

- A video will be recorded at [FHD/20M/30p] under [MP4].



Pan



Zoom in

- Use a tripod to minimize camera shake.

- 1 Set the mode dial to [M].
- 2 Set the time for panning or zooming.
 - MENU/SET → [] → [4K Live Cropping] → [40SEC]/[20SEC]



3 Set the cropping start frame.

- Select the range to be cropped and press .

(A) Cropping start frame

4 Set the cropping end frame.

- Select the range to be cropped and press .

(B) Cropping end frame

- To redo the settings for the position and size of the start frame and the end frame, press .

5 Start recording.

- Press the shutter button (C) or video rec. button (D).



(E) Elapsed recording time

(F) Set operating time

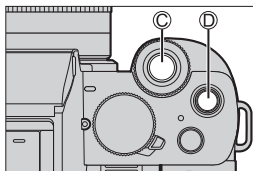
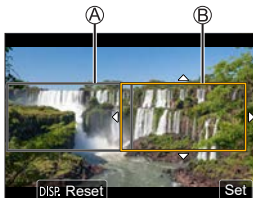

- When the set operating time has elapsed, recording automatically ends. To end recording midway, press the shutter button or video rec. button again.



❖ Operations for Setting the Cropping Frame

Button operation	Touch operation	Description of operation
	Touch	Moves the frame.
	Pinch out/ pinch in	Enlarges/reduces the frame.
[DISP.]	[Reset]	Start frame: Returns the frame position and size to the default settings. End frame: Cancels the settings for the position and size of the frame.
	[Set]	Confirms the frame position and size.



- The angle of view during recording becomes narrower.
- AF mode switches to  (IFace/Eye Detection). (The Eye Detection cannot be used.)
- Brightness measurements and focusing are performed within the cropping frame. To lock the focus point, set [Continuous AF] to [OFF], or set the focus mode to [MF].
- [Metering Mode] will be  (multi-metering).

Slow & Quick Mode



Records slow-motion videos and quick-motion videos.

- A video will be recorded at [FHD] under [MP4].

1 Set the mode dial to [S&Q].

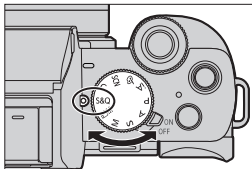

2 Set the recording settings.

- → [S&Q] →
[S&Q Exposure Mode]/
[S&Q Recording Frame Rate]/
[S&Q Effect]

- For details, refer to page [253](#).

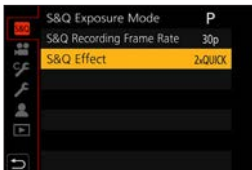

3 Close the menu.

- Press the shutter button halfway.

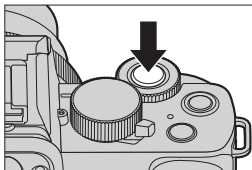

4 Start recording.

- Press the shutter button **A** or video rec. button **B**.

5 Stop recording.

- Press the shutter button or video rec. button again.

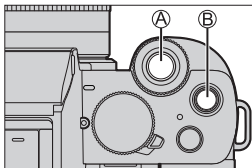

- It is also possible to display the selection screen by touching the recording mode icon in recording screen.



❖ Operations During Video Recording

You can change settings like exposure with touch operation.

- 1 Touch [S&Q].
- 2 Touch an icon.

T W ↑ ↓	Zoom (When using an interchangeable lens supporting power zoom)
F	Aperture value
SS	Shutter speed

[+/-]	Exposure compensation
ISO	ISO sensitivity
S&Q	S&Q Effect*1

*1 This cannot be operated during recording.

- 3 Drag the slide bar to set the item.
[▼]/[▲]: Changes the setting slowly.
[▼▼]/[▲▲]: Changes the setting quickly.
• If you touch icon (A), the screen of Step 2 is redisplayed.

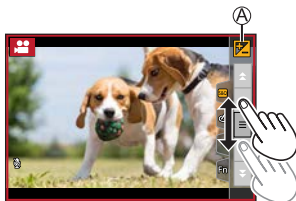

- Audio is not recorded in videos.

Slow & Quick Menu

❖ [S&Q Exposure Mode]

Select the exposure mode.

Settings: [P]/[A]/[S]/[M]

- You can perform the same exposure operations as the [P]/[A]/[S]/[M] modes.
- Program Shift does not work.

❖ [S&Q Recording Frame Rate]

Select the recording frame rate.

Settings: [60p]/[30p]

❖ [S&Q Effect]

Select the speed effect.

[8xQUICK]	Records videos sped up to about 8-times speed. Example: When set to [60p]: 8 frames/second. When set to [30p]: 4 frames/second.	Quick motion video
[4xQUICK]	Records videos sped up to about 4-times speed.	
[2xQUICK]	Records videos sped up to about 2-times speed.	
[2xSLOW]*1	Records videos slowed down to about half speed.	Slow motion video
[4xSLOW]*2	Records videos slowed down to about 1/4 speed.	

*1 When [S&Q Recording Frame Rate] is set to [60p], the angle of view becomes narrower.

*2 It can only be selected when [S&Q Recording Frame Rate] is set to [30p].
(The angle of view becomes narrower.)



- Depending on the settings, the recording screen may seem as if frames are missed.
- When the recording time of a single session exceeds the following duration, recording stops.
 - Quick motion video: 29 minutes and 50 seconds
(Example: If you record for 29 minutes and 50 seconds with [8xQUICK], the result will be a video that is approximately 4 minutes long.)
 - Slow motion video: 10 minutes
(Example: If you record for 10 minutes with [4xSLOW], the result will be a video that is approximately 40 minutes long.)



- The shutter speeds that can be set vary depending on [S&Q Recording Frame Rate], [S&Q Effect], and the focus mode.

Snap Movies



You can specify the recording time in advance and record videos casually like you take snapshots. The function also allows you to shift a focus at the start of recording and add fade in/out effects in advance.

- Video will be recorded with [FHD/20M/30p] in [MP4].

1 Set the camera to [Snap Movie].

- → → [Snap Movie] → [ON]

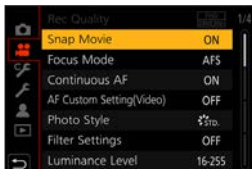

2 Close the menu.

- Press the shutter button halfway.

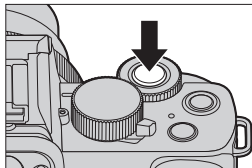

3 Start recording.

- Press the video rec. button.

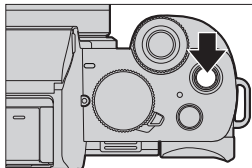

- Ⓐ Elapsed recording time
- Ⓑ Set recording time

- Immediately release the video rec. button after pressing it.
- You cannot stop video recording in the middle. The recording will stop automatically when the set recording time has elapsed.

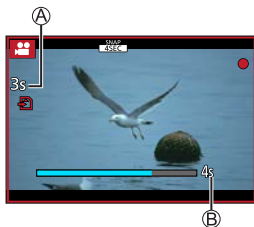

❖ Changing the settings

MENU/SET → [] → [Snap Movie] → Select [SET]

[Record time]	Sets the recording time of videos.
[Pull Focus]	Allows dramatic imaging expression by shifting focus gradually at the start of recording. (→ 257)
[Fade]	<p>Adds a fade-in (gradual appearance) effect to an image and audio as recording starts or adds a fade-out (gradual disappearance) effect to them as recording ends.</p> <p>[WHITE-IN] / [WHITE-OUT]: Adds a fade-in or fade-out effect that uses a white screen.</p> <p>[BLACK-IN] / [BLACK-OUT]: Adds a fade-in or fade-out effect that uses a black screen.</p> <p>[COLOR-IN] / [COLOR-OUT]: Adds an effect that fades in from black-and-white to color or an effect that fades out from color to black-and-white. Audio will be recorded normally.</p> <p>[OFF]</p>



- Videos recorded with [WHITE-IN] or [BLACK-IN] are displayed as all-white or all-black thumbnails in Playback Mode.
- If you assign [Snap Movie] to [Fn Button Set] in [Custom] ([Operation]) menu (→ 293), you can display a screen that lets you switch [Snap Movie] between [ON]/[OFF] by pressing the assigned function button. If you press [DISP.] while the screen is displayed, you can change the settings for Snap Movie.
- [Snap Movie] will be set to [OFF] when you connect to Wi-Fi with [Remote Shooting & View].
- When the following functions are being used, [Snap Movie] is not available:
 - Self Shot Mode
 - [Miniature Effect] ([📷] mode)
 - [4K PHOTO], [Post Focus]
 - [4K Live Cropping]

❖ Setting up [Pull Focus]

Set the frames that specify the positions where the [Pull Focus] starts (first position) and stops (second position).



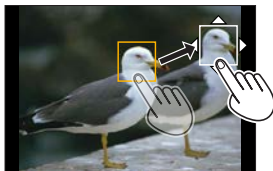

Touch operation

Touch a subject (first position), drag your finger to the desired location (second position), and release the finger.



- To cancel the frame settings, touch [📷 AF].



Button operation

- ① Press  (◀)
- ② Press ▲▼◀▶ to move the frame, and press  (First position)
 - If you press [DISP.] before pressing , the frame will return to the center.
- ③ Repeat step ② (Second position)
 - To cancel the frame settings, press .



- A greater effect can be achieved by creating a striking contrast of focus between the start and end positions, for example by shifting focus from the background to foreground, or vice versa.
- After setting focus, try to keep the distance between the subject and the camera constant.



- When the camera fails to set the frame, it returns to the first position.
- When [Pull Focus] is set to [ON]
 - AF Mode will be switched to , a setting specially designed for [Pull Focus].
 - If you take a picture, the Auto Focus operation  will take place at the first frame position.
- When [Metering Mode] is set to  (Spot), the spot metering target is fixed at the start position (first position) of [Pull Focus].
- When the following functions are being used, [Pull Focus] is not available:
 - Manual Focus
 - [Digital Zoom]

Video Settings (Auto Focus)

This section describes the use of AF when recording videos.



- In “6. Focus/Zoom”, the functions described work with both pictures and video. Please also refer to those sections.
 - Selecting the Focus Mode: → 124
 - Selecting the AF Mode: → 129
 - Moving the AF Area by Touch: → 142
 - Record Using Manual Focus: → 146
 - Recording with Zoom: → 151

[Continuous AF]



You can select how to set the focus in AF when recording videos.



→ [iA+] → Select [Continuous AF]

[ON]	Allow the focus to constantly adjust automatically while recording video.
[OFF]	The camera maintains the focus point at the start of recording.



- Depending on the recording conditions or lens used, the AF operation sound may be recorded during video recording.
If the operation sound bothers you, we recommend recording with [Continuous AF] set to [OFF].
- If the zoom is operated while recording videos, the subject may take a while to come into focus.
- When the following functions are being used, [Continuous AF] does not work:
 - [Pull Focus] ([Snap Movie])
 - [4K Live Cropping]

[AF Custom Setting(Video)]



You can fine-adjust the focusing method for video recording using [Continuous AF].

→ → Select [AF Custom Setting(Video)]

[ON]	Enables the following settings.	
[OFF]	Disables the following settings.	
[SET]	[AF Speed]	<p>[+] side: Focus moves at a faster speed.</p> <p>[-] side: Focus moves at a slower speed.</p>
	[AF Sensitivity]	<p>[+] side: When the distance to the subject changes significantly, the camera immediately readjusts the focus.</p> <p>[-] side: When the distance to the subject changes significantly, the camera waits for a little before readjusting the focus.</p>

Video Settings (Brightness)

This section describes the brightness settings used during video recording.



- In “8. Brightness (Exposure)/Coloring/Picture effect”, the functions described work with both pictures and video.

Please also refer to those sections.

- [Metering Mode]: →207
- Exposure Compensation: →208
- Locking Focus and Exposure (AF/AE Lock): →210
- ISO Sensitivity: →212
- White Balance (WB): →215
- [Photo Style]: →221
- [Filter Settings]: →224

[Luminance Level]



You can set the luminance range to suit the purpose of video recording.



→ [] → Select [Luminance Level]

Settings: [0-255]/[16-255]



- When [Photo Style] is set to [V-Log L], this is fixed to [0-255].

[ISO Sensitivity (video)]



Sets the lower and upper limits for ISO sensitivity when ISO sensitivity is set to [AUTO].

→ → Select [ISO Sensitivity (video)]

[ISO Auto Lower Limit Setting]	Sets the lower limit for ISO sensitivity when ISO sensitivity is [AUTO]. <ul style="list-style-type: none"> • Set in the range between [200] and [3200].
[ISO Auto Upper Limit Setting]	Sets the upper limit for ISO sensitivity when ISO sensitivity is [AUTO]. <ul style="list-style-type: none"> • Set to [AUTO] or in the range between [400] and [6400].

Video Settings (Audio)

Explains the audio setting during video recording.

[Sound Rec Level Disp.]



The sound recording level is displayed on the recording screen.

MENU/SET → **[iA+]** → Select [Sound Rec Level Disp.]

Settings: [ON]/[OFF]



[Sound Rec Level Adj.]



Sets the sound recording level.

MENU/SET → **[iA+]** → Select [Sound Rec Level Adj.]

[AUTO]	Automatically adjusts the audio input level to smooth out the loudness of sounds.
[MANUAL]	Manually adjusts the audio input level. Settings: [MUTE], [-12dB] to [+6dB]



- When set to [MUTE], this mutes the audio input.
 - **[Mute Icon]** is displayed in the recording screen.
 - Audio input from an external microphone will also be in mute.
- You cannot select [AUTO] when an external microphone is connected.
- Displayed dB values are approximate.

[Wind Noise Canceller]



This reduces the wind noise coming into the built-in microphone while maintaining sound quality.

→ → Select [Wind Noise Canceller]

[HIGH]	This effectively reduces the wind noise by reducing the low-pitched sound when a strong wind is detected.
[STANDARD]	This reduces wind noise without loss of sound quality by filtering out only wind noise.
[OFF]	—



- You may not see the full effect depending on the recording conditions.



- This function works only with the built-in microphone.
When an external microphone is connected, [Wind Cut] is displayed.
(→450)

[Lens Noise Cut]



You can reduce the zoom sound produced during video recording when you are using interchangeable lens compatible with power zoom.

→ → Select [Lens Noise Cut]

Settings: [ON]/[OFF]



- When this function is used, the sound quality may differ from that during normal operation.

[Built-in Mic]



Sets the sound pickup range when using the built-in microphone.

→ → Select [Built-in Mic]

Setting	Sound pickup range
[AUTO]	When the AF mode is set to ([Face/Eye Detection]) and the camera recognizes a face, it switches to ([TRACKING])*1. In other cases, it is set to ([SURROUND]).
[SURROUND]	Picks up a wide range of sounds in all directions.
[FRONT]	Picks up sounds in front of the camera.
[TRACKING]*1	When AF mode is set to ([Face/Eye Detection]) and the camera recognizes a face, it automatically adjusts the sound pickup range according to the location of your face. In other cases, it automatically adjusts the sound pickup range according to the angle of view.
[BACK]	Picks up sounds behind the camera.

*1 If you hold the camera vertically, the setting will temporarily switch to ([FRONT]).

- In Self Shot Mode, you can set the sound pickup range by touching the on the screen. (This does not work with [Built-in Mic] of the video menu.) (→86)
- When an external microphone is connected, [Built-in Mic] is not available.
- You can switch whether or not to display sound pickup range of the built-in mic on the recording screen:
 → [Built-in Mic Indicator] (→266)

[Built-in Mic Indicator]



Displays the sound pickup range and sound pickup target for the built-in microphone.

MENU/SET → [] → Select [Built-in Mic Indicator]

Settings: [ON]/[OFF]

- Ⓐ Sound pickup range
- Ⓑ Sound pickup target*¹

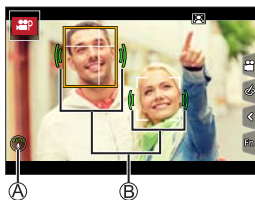

*1 When the [Built-in Mic] is in [] ([AUTO]) or [] ([TRACKING]), and a face is recognized by [] ([Face/Eye Detection]), the camera automatically displays the sound pickup target according to the state of the subject.



- When an external microphone is connected, [Built-in Mic Indicator] is not available.

Video Settings (Display)

This section describes the main assist functions that are convenient when recording.



- The [Custom] ([Monitor / Display]) menu has display assist functions such as the center marker. For details, refer to page 340.

[Zebra Pattern]



Parts that are brighter than the benchmark value are displayed with stripes.

You can also set the benchmark value and the breadth of the range so that the stripes are displayed on parts that are within the range of brightness you specify.



[ZEBRA1]



[ZEBRA2]

MENU/SET → [C] → [i] → Select [Zebra Pattern]

[ZEBRA1]	Parts that are brighter than the benchmark value are displayed with [ZEBRA1] stripes.		
[ZEBRA2]	Parts that are brighter than the benchmark value are displayed with [ZEBRA2] stripes.		
[OFF]	—		
[SET]	[Zebra 1]	50% to 105%	Sets the benchmark brightness.
	[Zebra 2]	[OFF]/50% to 105%	

[Frame Marker]



A frame with the set aspect ratio is displayed on the recording screen. This allows you to see during recording the angle of view that will be achieved with trimming (cropping) in post-processing.

MENU/SET → [🔧] → [i] → Select [Frame Marker]

	[ON]	Displays video grid lines on the recording screen.
	[OFF]	—
[SET]	[Frame Aspect]	Sets the aspect ratio of video grid lines. [2.39:1]/[2.35:1]/[2.00:1]/[1.85:1]/[16:9]/[4:3]/ [5:4]/[1:1]/[4:5]/[9:16]
	[Frame Color]	Sets the color of video grid lines.
	[Frame Mask]	Sets the outer side opacity of video grid lines. [100%]/[75%]/[50%]/[25%]/[OFF]

Log Recording



Setting [Photo Style] to [V-Log L] enables Log recording. Images finished with rich gradation can be created through post production processing.

 → /[] → [Photo Style] → Select [V-Log L]



- This camera records videos in 4:2:0/8 bit, so after post-production editing, luminance and color unevenness or noise may appear in areas such as blue skies, people's skin, and white walls. It is recommended to perform a test shot before hand and check the video after post production processing.
- Post-production processing is enabled by utilizing LUT (Look-Up Table). You can download LUT data from the following support site:
<https://panasonic.jp/support/global/cs/dsc/download/index3.html>
(English only)



- When [Photo Style] is set to [V-Log L], the recording screen and images output via HDMI will darken. (During video recording, it will not be outputted via HDMI.)

11. Playing Back and Editing of Images

This chapter explains how to play back and delete pictures and videos. It also explains editing images.



- Images recorded on devices other than this one may not be played back or edited correctly on this camera.



- For [Playback] menu items not listed here, refer to "[Playback] Menu" beginning on page 360.

Playing Back Pictures

1 Display the playback screen.

- Press [▶].

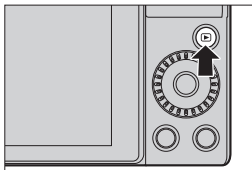

2 Select a picture.

- Select the pictures by pressing ◀▶.
- You can move continuously through images by pressing and holding ◀▶.
- You can also select by rotating 🌞.
- You can also move through images by dragging the screen horizontally. By leaving your finger touching the left or right edge of the screen after dragging to change the image, you can continuously move through images.



3 Stop playback.

- Press the shutter button halfway.
- You can also stop playback by pressing [▶].

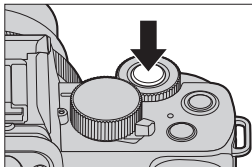

Playing Back Videos

1 Display the playback screen.

- Press [▶].

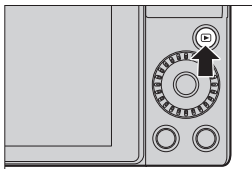

2 Select a video.

- For information about how to select images, refer to page 270.
- The [👤] video icon is displayed for a video.

(A) Video recording time

- The video recording time is displayed on the screen.



3 Play back the video.

(B) Elapsed playback time



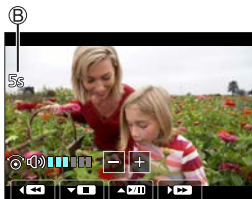









- Press ▲.
- You can also start playback by touching [▶] at the center of the screen.
- Videos recorded with [Snap Movie] are played back automatically.



4 Stop playback.

- Press ▼.

❖ Operations During Video Playback

Button operation	Touch operation	Description of operation
▲		Plays/pauses.
▼		Stops.
◀		Performs fast-rewind playback. • If you press ◀ again, the fast-rewind speed increases.
		Performs frame-by-frame rewinding (while paused).
▶		Performs fast-forward playback. • If you press ▶ again, the fast-forward speed increases.
		Performs frame-by-frame forwarding (while paused).
		Extracts a picture (while paused). (→ 274)
		Reduces the volume.
		Increases the volume.

❖ Operations during automatic Snap Movie playback

▲	Playback from the beginning
◀	Returning to the previous picture
▶	Scrolling to the next picture

- If you touch the screen, automatic playback will stop.



- The camera can play back videos in an MP4 format.
- To play back videos on a PC, use the "PHOTOfunSTUDIO" software.

Extracting a Picture

Extract one frame of a video and save it as a JPEG image.

1 Pause playback at the position you wish to extract a picture.

- Press **▲**.
- To fine-adjust the position, press **◀▶** (rewind frame-by-frame or forward frame-by-frame).



2 Save the picture.

- Press **MENU/SET**.
- You can also save the picture by touching [**◀▶**] **📷**.



- The picture created from a video is saved with a [**📷**] picture quality. The picture is saved with a size according to the resolution of the [Picture Size].
- The image quality of a picture created from a video may be coarser than normal.
- [**📷**] is displayed on the detailed information display screen for a picture created from a video.





Switching the Display Mode

You can use features to do things like enlarge recorded images for display and switch to thumbnail display to display multiple images at once (multi-playback). You can also switch to calendar display to show images of a selected recording date.

Enlarged Display



Playback images can be displayed enlarged (Playback Zoom).

Enlarging the playback screen.

- Rotate  to the right.
- The playback screen is enlarged in the order of 2x  4x  8x  16x.
- Rotating  to the left returns to the previous display size.
- Pictures taken with [Quality] set to [RAW] cannot be displayed enlarged at 16x.







❖ Operations During Enlarged Display

Button operation	Touch operation	Description of operation
—	Pinch out/ pinch in	Enlarges/reduces the screen in small steps.
	—	Enlarges/reduces the screen.
	Drag	Moves the enlarged display position.
	—	Forwards or rewinds images while maintaining the same zoom magnification and zoom position.

Thumbnail Screen

1 Switch to thumbnail display.

- Rotate  to the left.
- The display is switched in the order of 12-image screen  30-image screen.
- Rotating  to the left during 30-image screen display switches to calendar display. (→277)
- Rotating  to the right returns to the previous display.
- You can also switch the display by touching an icon.





: 1-image screen

: 12-image screen

: 30-image screen

 [CAL]: Calendar

2 Select an image.

- Press     to select an image and then press .

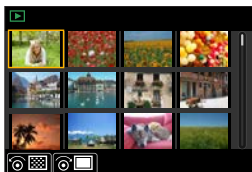



• You can scroll the screen by dragging the thumbnail display up or down.



• Images indicated with  cannot be played back.



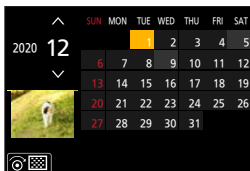

Calendar Playback

1 Switch to calendar playback.







- Rotate  to the left.
- The display is switched in the order of thumbnail screen (12 images)
 - ↳ Thumbnail screen (30 images)
 - ↳ Calendar playback.
- Rotating  to the right returns to the previous display.



2 Select the recording date.

- Press     to select a date and then press .

3 Select an image.

- Press     to select an image and then press .
- Rotating  to the left returns to calendar playback.

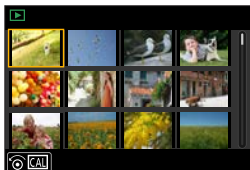





- The range that the calendar can be displayed is January 2000 to December 2099.
- Pictures taken with destination settings made in [World Time] are displayed in the calendar screen using the appropriate date for the destination's time zone.

Group Images

Images recorded with Time Lapse Shot or Stop Motion Animation recording are handled as group images in the camera, and can be deleted and edited on a group basis.

You can also delete and edit each image in a group individually.

❖ Images Handled as Group Images by the Camera

	Group images saved with [4K PHOTO Bulk Saving].
	Group images recorded with Focus Bracket.
	Group images recorded with Time Lapse Shot.
	Group images recorded with Stop Motion Animation recording.



❖ Playing the Images in a Group One by One

Operations such as displaying thumbnails and deleting images are available with images in groups just as with normal playback.

- 1 Select the group image in the playback state. (→270)
- 2 Press ▼ to display the images in the group.
 - You can also perform the same operation by touching the group image icon.
- 3 Press ◀▶ to select an image.
 - To return to the normal playback screen, press ▼ or touch [] again.

Deleting Images





- Images cannot be restored once they have been deleted. Carefully confirm the images before deletion.
- If you delete a group image, all images in the group are deleted.

❖ [Delete Single]

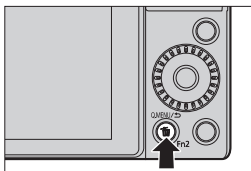
- 1 Press [] in playback state.
- 2 Press ▲▼ to select [Delete Single] and then press .



❖ [Delete Multi]

- 1 Press [] in playback state.
- 2 Press ▲▼ to select [Delete Multi] and then press .
 - 1 Press ▲▼◀▶ to select the image to delete and then press .
 - [] is displayed for the selected image.
 - If you press  again, the selection is canceled.
 - Up to 100 images can be selected.
 - 2 Press [DISP.] to delete the selected image.

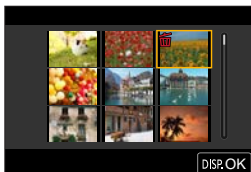

- Depending on the number of images to be deleted, it may take some time to delete them.



- You can set which of [Yes] and [No] is selected initially in the confirmation screen when deleting:
 - [] ⇒ [Delete Confirmation] (→369)
- You can delete all of the images on a card, or all images except those with a rating set:
 - [] ⇒ [Delete All Images] (→369)

[Light Composition]

Select multiple frames from 4K burst files that you wish to combine. Parts of the image that are brighter than the preceding frame will be superimposed on the preceding frame to combine the frames into one picture.

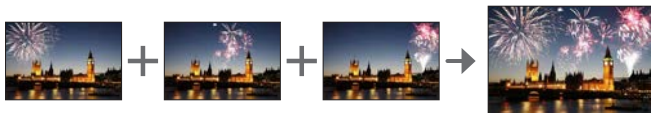

1 Select [Light Composition].

- Press **MENU/SET** → [▶] → [Light Composition]

2 Select the 4K burst file.



- Press ◀▶ to select an image and then press **MENU/SET**.



3 Select the combining method.

- Press ▲▼ to select the combining method and then press **MENU/SET**.



❖ [Composite Merging]: Selecting frames to combine

- 1 Drag the slide bar or use ▲▼◀▶ to select the frames to combine.
- 2 Press .
 - The selected frames are remembered, and the display goes to the preview screen.
 - Use ▲▼ to select items and press  to perform the following operations.
 - [Next]: Lets you select more frames for combining.
 - [Reselect]: Discards the frame selected immediately before and lets you select a different image.



- 3 Repeat steps 1 - 2 to select more frames to combine (up to 40 frames).
- 4 Press ▼ to select [Save], and then press .

❖ [Range Merging]: Selecting a range to combine

- 1 Select the frame of the first picture and then press .
 - The selection method is the same as in step 1 of [Composite Merging] setting.
- 2 Select the frame of the last picture and then press .



- Pictures are saved in JPEG format. Recording information (Exif information) of the first frame such as shutter speed, aperture, and ISO sensitivity are also registered.

[Sequence Composition]

Select multiple frames from a 4K burst file to create a sequence composition of a moving subject into one picture.



1 Select [Sequence Composition].

- Press **MENU/SET** → **[▶]** → [Sequence Composition]

2 Select the 4K burst file.

- Press **◀▶** to select an image and then press **MENU/SET**.

3 Select frames to combine.

Select the frames so that the moving subject will not overlap on the preceding or subsequent frames. (The sequence composition may not be created properly if the subject overlaps.)

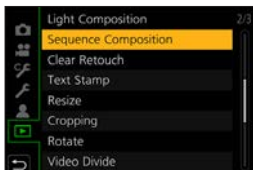

① Drag the slide bar or use ▲▼◀▶ to select the frames to combine.

② Press .

- The selected frames are remembered, and the display goes to the preview screen.
- Use ▲▼ to select items and press  to perform the following operations.
 - [Next]: Lets you select more frames for combining.
 - [Reselect]: Discards the frame selected immediately before and lets you select a different image.

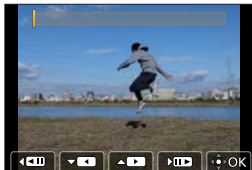

③ Repeat steps ① - ② to select more frames to combine (from 3 to 40 frames).

④ Press ▼ to select [Save], and then press .



• We recommend using a tripod to take pictures for [Sequence Composition].



• Pictures are saved in JPEG format. Recording information (Exif information) of the first frame such as shutter speed, aperture, and ISO sensitivity are also registered.

[Clear Retouch]

You can erase unnecessary parts recorded on the pictures taken.

- The erasure operation can only be performed by touching. [Clear Retouch] automatically enables the touch operation.



1 Select [Clear Retouch].

- Press **MENU/SET** → [] → [Clear Retouch]

2 Select a picture.

- Press ◀▶ to select a picture and then press **MENU/SET**.



3 Drag your finger over the part you want to erase.

- The parts to be erased are colored.
- Touching [Undo] will return the colored part back to its previous state.

4 Touch [Set].

5 Save the image.

- Touch [Save] or press **MENU/SET**.

**Erasing details (enlarging the display)****① Touch [SCALING]**

- On the touch screen, pinch out your two fingers to zoom in, and pinch in your two fingers to zoom out.
- Dragging the screen allows you to move the enlarged part.

**② Touch [REMOVE]**

- This will bring you back to the operation of dragging your finger over the part you want to erase. The part you want to erase can be dragged even while the picture is enlarged.



- Pictures may appear unnatural because the background of deleted parts is artificially created.
- Edit group pictures one by one.
- When the following functions are being used, [Clear Retouch] is not available:
 - When the viewfinder is in use.
 - HDMI output
- [Clear Retouch] is not available for images recorded using the following functions:
 - Video recording, [4K PHOTO], [Post Focus]
 - [RAW] ([Quality])

[RAW Processing]

This processes pictures taken in RAW format on the camera and saves them in JPEG format.

1 Select [RAW Processing].

- Press **MENU/SET** → [▶] → [RAW Processing]



2 Select the RAW image.

- Press ◀▶ to select an image and then press **MENU/SET**.
- When selecting an image from group images, press ▼ and then select an image in the group. Press ▼ again to return to the normal selection screen.
- The settings from the time of recording are reflected in displayed images.



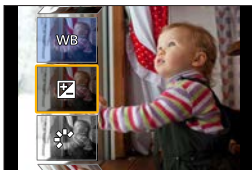

3 Select a setting item.

- Press ▲▼ to select an item and then press **MENU/SET**.



4 Change the setting.



- Rotate  or .
- The image can be enlarged/reduced by pinching out/pinching in the screen.



5 Confirm the setting.



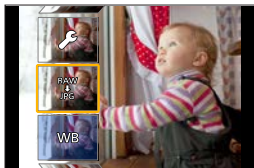

- Press .
- The screen of Step 3 reappears.
To set another item, repeat Steps 3 to 5.

6 Save the image.

- Press   to select [Begin Processing] and then press .



❖ Setting Items ([RAW Processing])

[Begin Processing]	Saves the image.
[White Balance]	<p>Selects and adjusts the white balance.</p> <p>Selecting the item with  enables processing with the same setting as at the time of recording.</p> <ul style="list-style-type: none"> • If you press  in the [White Balance] selection screen, the white balance adjustment screen appears. • If you press  while  to  is selected, the color temperature setting screen appears.
[Brightness correction]	<p>Corrects the brightness.</p> <ul style="list-style-type: none"> • The [Brightness correction] effect differs from the effect of exposure compensation during recording.





[Photo Style]	Selects a Photo Style. • You cannot select a Photo Style for images recorded with [V-Log L]. You cannot select [V-Log L] for images not recorded with [V-Log L].
[i.Dynamic]	Selects the setting of [i.Dynamic].
[Contrast]	Adjusts the contrast.
[Highlight]	Adjusts the brightness of bright portions.
[Shadow]	Adjusts the brightness of dark portions.
[Saturation]^{*1}/ [Color Tone]^{*2}	Adjusts the saturation or color tone.
[Filter Effect]^{*2}	Selects filter effects.
[Grain Effect]^{*2}	Selects a grain effect setting.
[Noise Reduction]	Sets noise reduction.
[i.Resolution]	You can select the [i.Resolution] settings.
[Sharpness]	Adjusts the sharpness.
[More Settings]	[Reinstate Adjustments]: Returns the settings to the ones from the time of recording. [Color Space]: Selects a Color Space setting from [sRGB] or [AdobeRGB]. [Picture Size]: Selects the size for storing images.

*1 Available when items other than [Monochrome], [L.Monochrome], [L.Monochrome D] or [V-Log L] are selected in [Photo Style].

*2 Available when [Monochrome], [L.Monochrome], or [L.Monochrome D] is selected in [Photo Style].

❖ Displaying a Comparison Screen

You can change a setting while checking the effect by displaying images with the applied setting value side by side.

- 1 Press [DISP.] in the screen of Step 4.
 - The image with the current setting (A) is displayed at the center.
 - Touching the image with the current setting enlarges it. Touching [] returns to the original display.
 - If you have selected [Noise Reduction], [i.Resolution], or [Sharpness], the comparison screen is not displayed.
- 2 Rotate  or  to change the setting.
- 3 Press  to confirm the setting.

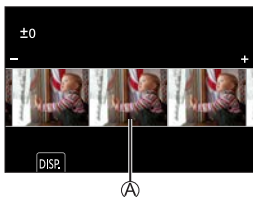

- RAW images recorded with the camera are always recorded in the [L] size of [4:3].
With this function, images are processed with the aspect ratio and the angle of view of [Ex. Tele Conv.] ([Rec]) from the time of recording.
- The [White Balance] item is fixed to the setting from the time of recording for pictures recorded with multiple exposures.
- The results of RAW processing with this function and with the "SILKYPIX Developer Studio" software do not completely match.
- [RAW Processing] is not available while using the HDMI output.

[Video Divide]

Divide a recorded video or 4K burst file into two.



- Images cannot be returned to their original state once they have been divided. Carefully confirm the images before performing the divide operation.
- Do not remove the card or battery from the camera during the divide process. The images may be lost.

1 Select [Video Divide].

- Press **MENU/SET** → **[▶]** → **[Video Divide]**



2 Select and play the image.

- Press **◀▶** to select an image and then press **MENU/SET**.
- You can also select by rotating **☀** or **⚙**.



3 Pause playback at the position you wish to divide.

- Press **▲**.
- To fine-adjust the position, press **◀▶** (frame-by-frame rewind or frame-by-frame forward).



4 Divide the video.

- Press **▼**.



- Dividing the video at a point close to the start or end may not be possible.
- Videos with a short recording time cannot be divided.

12. Camera Customization

This chapter describes the customization function with which you can configure the camera to your preferred settings.

Change how buttons, dials, etc. on the camera are to be operated.

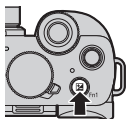

[Fn Button Set]

→292

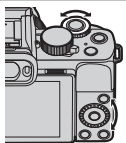

[Dial Operation Switch Setup]

→297

Register the currently set information of the camera.

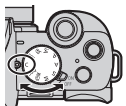

Custom mode

→303

Change menu display items.

Quick menu

→299

My Menu

→305



- Detailed settings for camera operations and screen display are available in the [Custom] menu. (→331)

Fn Buttons

You can register functions to the Fn (Function) buttons. Different functions can be set for both during recording and playback.

❖ Fn Button Default Settings

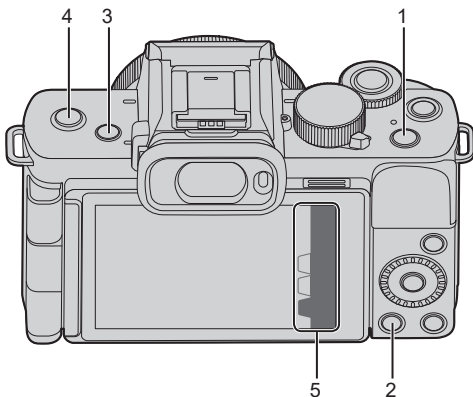

	Fn buttons	[Setting in REC mode]	[Setting in PLAY mode]
1	[Fn1]	[Exposure Comp.]	[Wi-Fi]
2	[Fn2]	[Q.MENU]	<ul style="list-style-type: none"> • Cannot be used as Fn buttons during playback.
3	[Fn3]	[LVF/Monitor Switch]	[LVF/Monitor Switch]
4	[Fn4]	[OFF]	[Send Image (Smartphone)]
5	[Fn5]	[Wi-Fi]	<ul style="list-style-type: none"> • Cannot be used as Fn buttons during playback.
	[Fn6]	[Preview]	
	[Fn7]	[Level Gauge]	
	[Fn8]	[Histogram]	
	[Fn9]	[Built-in Mic]	

Register Functions to the Fn Buttons

1 Select [Fn Button Set].

- Press **MENU/SET** → [C/W] → [Fn Button Set] → [Setting in REC mode]/[Setting in PLAY mode]

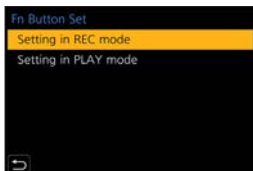

2 Select the button.

- Press **▲▼** to select the button and then press **MENU/SET**.
- Selection is also possible by rotating **DISP** or **Q/MENU**.



3 Register the function.

- Press **▲▼** to select a function and then press **MENU/SET**.
- Selection is also possible by rotating **DISP** or **Q/MENU**.

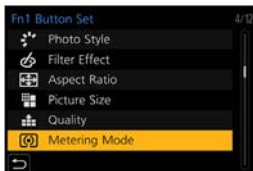

- You can also touch [Fn1] on the monitor recording information screen (→ 63) to display the screen in Step 2.
- You can also press and hold the Fn button (2 sec.) to display the screen in Step 3.
(This may not be displayed depending on the registered function and on the button type.)

❖ Functions that can be assigned in [Setting in REC mode]

[4K Photo Mode]	→ 162	[Quality]	→ 119
[Exposure Comp.]	→ 208	[Metering Mode]	→ 207
[Wi-Fi]	→ 380	[Burst Rate]	→ 321
[Q.MENU]	→ 61	[Self Timer]	→ 184
[Video Record]	→ 238	[Live View Composite]	→ 101
[LVF/Monitor Switch]	→ 56	[Bracket]	→ 195
[LVF/Monitor Disp. Style]	→ 345	[Focus Mode]	→ 124
[AF/AE LOCK]	→ 210	[Highlight Shadow]	→ 316
[AF-ON]	→ 211	[i.Dynamic]	→ 317
[Preview]	→ 104	[i.Resolution]	→ 317
[One Push AE]		[Min. Shtr Speed]	→ 319
• Sets the aperture value and shutter speed according to the proper exposure determined by the camera.		[HDR]	→ 323
[Touch AE]	→ 69	[Shutter Type]	→ 202
[Level Gauge]	→ 59	[Flash Mode]	→ 227
[Focus Area Set]		[Flash Adjust.]	→ 231
• Displays the AF area/MF Assist transition screen.		[Wireless Flash Setup]	→ 234
[Zoom Control]	→ 153	[Ex. Tele Conv.]	→ 152
[Operation Lock]		[Digital Zoom]	→ 155
• Disables the operations that were set using [Operation Lock Setting] in the [Custom] ([Operation]) menu.		[Stabilizer]	→ 204
[Focus Ring Lock]	→ 339	[E-Stabilization (Video)]	→ 205
[Dial Operation Switch]	→ 298	[4K Live Cropping]	→ 247
[Photo Style]	→ 221	[Snap Movie]	→ 255
[Filter Effect]	→ 224	[Motion Pic. Rec Quality]	→ 239
[Aspect Ratio]	→ 117	[S&Q Effect]	→ 254
[Picture Size]	→ 118	[Picture Mode in Rec.]	→ 243
		[Sound Rec Level Disp.]	→ 263
		[Sound Rec Level Adj.]	→ 263
		[Built-in Mic]	→ 265

[Special Mic. Directivity Adjust]	→450	[Zoom Speed]	→156
[Silent Mode]	→201	[Sensitivity]	→212
[Peaking]	→342	[White Balance]	→215
[Histogram]	→343	[AF Mode/MF]	→129
[Guide Line]	→343		→146
[Frame Marker]	→268	[Drive Mode]	→157
[Zebra Pattern]	→344	[Rec / Playback Switch]	
[Monochrome Live View]	→340	• Switches to the playback screen.	
[Constant Preview]	→341	[Off]	
[Live View Boost]	→341	• Set when not using as an Fn button.	
[Rec Area]	→346	[Restore to Default]	
[Step Zoom]	→156	• Restore the default settings for the Fn button. (→292)	

❖ Functions that can be assigned in [Setting in PLAY mode]



[Wi-Fi]	→380	[Rating★2]	→362
[LVF/Monitor Switch]	→56	[Rating★3]	→362
[Rec / Playback Switch]		[Rating★4]	→362
• Switches to the recording screen.		[Rating★5]	→362
[Send Image (Smartphone)]	→406	[RAW Processing]	→286
[4K PHOTO Play]		[4K PHOTO Bulk Saving]	→175
• Displays the screen to select pictures to save from a 4K burst file.		[Off]	
[Delete Single]	→279	• Set when not using as an Fn button.	
[Protect]	→362	[Restore to Default]	
[Rating★1]	→362	• Restore the default settings for the Fn button. (→292)	

Use the Fn Buttons

During recording, pressing the Fn buttons enables usage of the functions registered in [Setting in REC mode], and during playback, usage of the functions registered in [Setting in PLAY mode].

1 Press the Fn button.

2 Select a setting item.

- Press ◀▶ to select a setting item and then press .
- Selection is also possible by rotating  or .
- Display and selection methods of a setting item differ depending on the menu item.

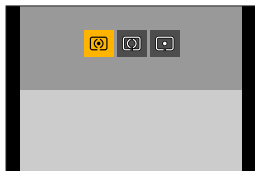

❖ Use [Fn5] to [Fn9] (Touch Icons)

During recording, you can use the Fn buttons within the Touch Tab.

- 1 Touch .
- 2 Touch one of [Fn5] to [Fn9].



[Dial Operation Switch]

This temporarily changes the functions operated with ☀️ (front dial) and ⚙️ (control dial).

Register Functions to the Dials

1 Select [Dial Operation Switch Setup].

- **MENU/SET** → [C/W] → [☀️] → [Dial Set.] → [Dial Operation Switch Setup] → [☀️]/[⚙️]

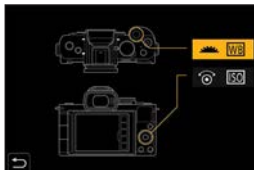

2 Register the function.

- Press ▲▼ to select a function and then press **MENU/SET**.
- Selection is also possible by rotating ☀️ or ⚙️.

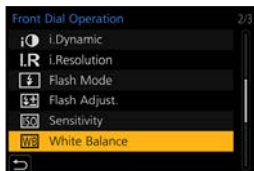

❖ Functions That Can Be Registered

- | | |
|------------------------------|-----------------------------|
| – [4K Photo Mode] (→ 162) | – [i.Resolution] (→ 317) |
| – [Photo Style] (→ 221) | – [Flash Mode] (→ 227) |
| – [Filter Effect] (→ 224) | – [Flash Adjust.] (→ 231) |
| – [Aspect Ratio] (→ 117) | – [Sensitivity]*1 (→ 212) |
| – [Focus Mode] (→ 124) | – [White Balance]*2 (→ 215) |
| – [Highlight Shadow] (→ 316) | – [AF Mode] (→ 129) |
| – [i.Dynamic] (→ 317) | – [Drive Mode] (→ 157) |

*1 ⚙️ default setting



*2 ☀️ default setting

- [Highlight Shadow] uses the two dials.

Temporarily Change Dial Operation



1 Set [Dial Operation Switch] to the Fn button. (→292)

2 Switch dial operation.

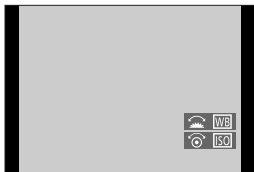
- Press the Fn button set in Step 1.
- A guide will display the functions registered to  and .
- If no operations are performed, then several seconds later, the guide disappears.



3 Set the registered function.

- Rotate  or  while the guide is displayed.



4 Confirm your selection.

- Press the shutter button halfway.

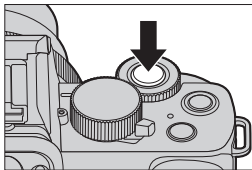

Quick Menu Customization

For information about Quick menu operation methods, refer to page 61.

Register to the Quick Menu

Change the menus to be displayed in the Quick menu.

Up to 15 items can be set to the Quick Menu.

1 Select [Q.MENU].

-  →  →  → [Q.MENU] → [CUSTOM]



2 Close the menu.

- Press the shutter button halfway.

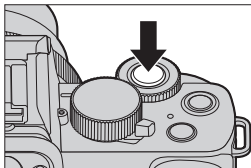

3 Display the Quick menu.

- Press [Q.MENU].

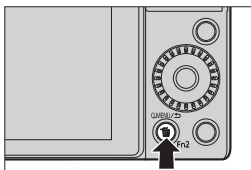

4 Display the editing screen for the Quick menu.

- Press \blacktriangledown and select [Q], and then press MENU/SET .

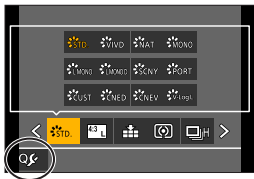

5 Register menu items.

- Press \blacktriangle \blacktriangledown \blacktriangleleft \blacktriangleright to select the menu item in the top row and press MENU/SET .
- Items that are displayed in light gray in the top row have already been set.

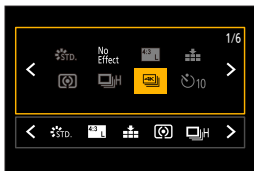

6 Select the item position.

- Press \blacktriangleleft \blacktriangleright to select the empty space in the bottom row and press MENU/SET .
- You can also set the menu item by dragging it from the top row to the bottom row.
- If there is no empty space in the bottom row, you can replace an existing item with a new select item by selecting the existing item.
- To cancel the setting, move to the bottom row by pressing \blacktriangledown and select an item to cancel, and then press MENU/SET .
- Press the [Q.MENU] to return to the screen in Step 4.



7 Close the Quick menu.

- Press the shutter button halfway.
- You can also close the menu by pressing [Q.MENU].

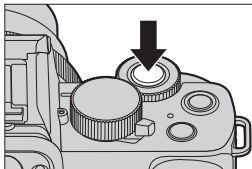

❖ Functions That Can Be Registered

[Photo Style]	→221	[Histogram]	→343
[Filter Effect]	→224	[Guide Line]	→343
[Picture Setting]	→117	[Frame Marker]	→268
	→118	[Zebra Pattern]	→344
[Quality]	→119	[Monochrome Live View]	→340
[Metering Mode]	→207	[Constant Preview]	→341
[Burst Rate]	→321	[Live View Boost]	→341
[4K PHOTO]	→162	[Rec Area]	→346
[Self Timer]	→184	[Step Zoom]	→156
[Bracket]	→195	[Zoom Speed]	→156
[Focus Mode]	→124	[Sensitivity]	→212
[i.Dynamic]	→317	[White Balance]	→215
[i.Resolution]	→317	[AF Mode]	→129
[Min. Shtr Speed]	→319	[Drive Mode]	→157
[HDR]	→323		
[Shutter Type]	→202		
[Flash Mode]	→227		
[Flash Adjust.]	→231		
[Ex. Tele Conv.]	→152		
[Digital Zoom]	→155		
[Stabilizer]	→205		
[E-Stabilization (Video)]	→205		
[4K Live Cropping]	→247		
[Snap Movie]	→255		
[Motion Pic. Rec Quality]	→239		
[S&Q Effect]	→254		
[Picture Mode in Rec.]	→243		
[Sound Rec Level Disp.]	→263		
[Silent Mode]	→201		
[Peaking]	→342		

Custom Mode



Menu settings that match your preferences can be registered in Custom mode ([C1] to [C3]). You can use registered settings by switching the custom mode menu to [SET1] to [SET3] modes.

Register in Custom Mode

You can register the currently set information of the camera.

At the time of purchase, the default settings of the [P] mode menus are registered with all Custom modes.

1 Set to recording mode and menu settings of the state you wish to save.

2 Select [Cust.Set Mem.].

- → [] → [Cust.Set Mem.]

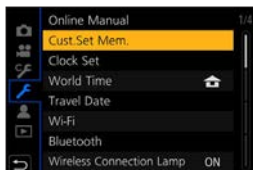

3 Register.

- Select the save-to number and then press .



- The following menu items are not registered as custom settings.
 - [My Menu], [Setup] menu, [Playback] menu
 - [Custom] menu ([Menu Guide], data registered in [Face Recog.], [Profile Setup] settings)



- You cannot register [iA]/[iA+] mode in Custom mode.

Using Custom Mode

Set the mode dial to [C].

- The last-used Custom mode will be called up.

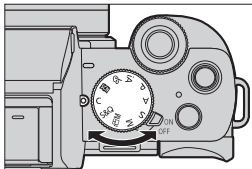

❖ Switching the Custom Mode

 → [C] → [SET1]/[SET2]/[SET3]



- It is also possible to display the selection screen by touching the recording mode icon in recording screen.



❖ Changing Registered Details

Registered settings do not change even if you change the camera settings temporarily with the mode dial set to [C].



To change the registered details, overwrite them by using [Cust.Set Mem.] in the [Setup] menu.

My Menu

Register frequently-used menus in My Menu.
A maximum of 23 items can be registered.

Registration in My Menu

1 Select [Add].

-  → [] → [My Menu Setting] → [Add]



2 Register.

- Select the menu to register and then press .



❖ Calling up My Menu

Call up the menus registered in My Menu.

-  → [] → Registered menus

Edit My Menu

You can reorder the display order of My Menu, and delete unnecessary menus.

 ⇒  ⇒ Select [My Menu Setting]

[Add]	Selects and registers the menus to be displayed in My Menu.
[Sorting]	Changes the order of My Menu. Select the menu to change, then set the destination.
[Delete]	Deletes menus that are registered to My Menu. [Delete Item]: Selects the menu, then deletes. [Delete All]: Deletes all menus registered in My Menu.
[Display from My Menu]	Displays My Menu first when displaying a menu. [ON]: Displays My Menu. [OFF]: Displays the last-used menu.

13. Menu Guide

This chapter provides a list of menus and describes them in detail.

- For information about menu operation methods, refer to page 65.

Search the Menus

List of Menu → 308

Learn About the Menu Functions and Default Settings



[Rec] menu → 314

[Motion Picture] menu → 327

[Custom] menu → 331

[Setup] menu → 352

[My Menu] → 305

[Playback] menu → 360

Menus displayed in specific recording modes

[Intelligent Auto] menu → 312

[Creative Video] menu → 312

[Slow & Quick] menu → 313

[Custom Mode] menu → 304

[Scene Guide] menu → 313

[Creative Control] menu → 313

Enter Characters

Entering Characters → 370



- For details about “List of Functions That Can Be Set in Each Recording Mode”, refer to page 488.

List of Menu

 : Menu items common to the [Rec] menu and [Motion Picture] menu.
Their settings are synchronized.

[Intelligent Auto] menu

[Intelligent Auto Mode]	→312
[iHandheld Night Shot]	→312
[iHDR]	→312

[Creative Video] menu

[Exposure Mode]	→312
[4K Live Cropping]	→312

[Slow & Quick] menu

[S&Q Exposure Mode]	→313
[S&Q Recording Frame Rate]	→313
[S&Q Effect]	→313











[Scene Guide] menu

[Scene Switch]	→313
----------------	------

[Creative Control] menu

[Filter Effect]	→313
[Simultaneous Record w/o Filter]	→313











[Rec] menu

[Aspect Ratio]	→314
[Picture Size]	→314
[Quality]	→314
[Focus Mode]	 →314
[AF Sensitivity(Photo)]	→314
[Photo Style]	 →314
[Filter Settings]	 →314
[Color Space]	→315
[Metering Mode]	 →315
[Highlight Shadow]	 →316
[i.Dynamic]	 →317
[i.Resolution]	 →317
[Flash]	→318
[Red-Eye Removal]	→319
[ISO Sensitivity (photo)]	→319
[Min. Shtr Speed]	→319
[Long Shtr NR]	→320
[Shading Comp.]	→320
[Diffraction Compensation]	 →321
[Stabilizer]	 →321
[Ex. Tele Conv.] ([Rec])	→321
[Digital Zoom]	 →321
[Burst Rate]	→321
[4K PHOTO]	→321
[Self Timer]	 →322
[Time Lapse Shot]	→322
[Stop Motion Animation]	→322



📷 [Rec] menu (Continued)

[Live View Composite]	→322
[Silent Mode]	→322
[Shutter Type]	→322
[Shutter Delay]	→323
[Bracket]	→323
[HDR]	→323
[Multi Exp.]	→325

👤 [Motion Picture] menu

[Rec Quality]	→327
[Snap Movie]	→327
[Focus Mode]	 →327
[Continuous AF]	→327
[AF Custom Setting(Video)]	→327
[Photo Style]	 →327
[Filter Settings]	 →328
[Luminance Level]	→328
[Metering Mode]	 →328
[Highlight Shadow]	 →328
[i.Dynamic]	 →328
[i.Resolution]	 →328
[ISO Sensitivity (video)]	→328
[Diffraction Compensation]	 →329
[Stabilizer]	 →329
[Flkr Decrease]	→329
[Ex. Tele Conv.] ([Motion Picture])	→329
[Digital Zoom]	 →329
[Picture Mode in Rec.]	→329
[Self Timer]	 →329
[Sound Rec Level Disp.]	→329
[Sound Rec Level Adj.]	→329
[Wind Noise Canceller/]	→330
[Wind Cut]	→330
[Lens Noise Cut]	→330
[Built-in Mic]	→330
[Built-in Mic Indicator]	→330
[Special Mic.]	→330

[Custom] menu

 [Exposure]	→331
[ISO Increments]	→331
[Extended ISO]	→331
[Exposure Comp. Reset]	→331
 [Focus / Release Shutter]	→331
[AF/AE Lock]	→331
[AF/AE Lock Hold]	→331
[Shutter AF]	→331
[Half Press Release]	→331
[Quick AF]	→332
[Eye Sensor AF]	→332
[Pinpoint AF Setting]	→332
[AF Assist Lamp]	→333
[Direct Focus Area]	→334
[Focus/Release Priority]	→334
[Focus Switching for Vert / Hor]	→335
[Loop Movement Focus Frame]	→335
[AF Area Display]	→335
[AF+MF]	→336
[MF Assist]	→336
[MF Assist Display]	→336
 [Operation]	→337
[Fn Button Set]	→337
[ISO Displayed Setting]	→337
[Exposure Comp. Disp. Setting]	→337
[Q.MENU]	→337
[Dial Set.]	→338
[Operation Lock Setting]	→339
[Focus Ring Lock]	→339
[Video Rec. Button]	→339
[Touch Settings]	→339

 [Monitor / Display]	→340
[Auto Review]	→340
[Monochrome Live View]	→340
[Constant Preview]	→341
[Live View Boost]	→341
[Peaking]	→342
[Histogram]	→343
[Guide Line]	→343
[Frame Marker]	→344
[Center Marker]	→344
[Highlight]	→344
[Zebra Pattern]	→344
[Expo.Meter]	→345
[MF Guide]	→345
[LVF/Monitor Disp. Set]	→345
[Monitor Info. Disp.]	→345
[Rec Area]	→346
[Remaining Disp.]	→346
[Red REC Frame Indicator]	→346
[Menu Guide]	→346
 [Lens / Others]	→347
[Lens Position Resume]	→347
[Power Zoom Lens]	→347
[Lens Fn Button Setting]	→347
[Aperture Ring Increment]	→348
[Self Timer Auto Off]	→348
[Self Shot]	→348
[AF After Countdown]	→348
[Face Recog.]	→349
[Profile Setup]	→351

 **[Setup] menu**

[Online Manual]	→352
[Cust.Set Mem.]	→352
[Clock Set]	→352
[World Time]	→352
[Travel Date]	→353
[Wi-Fi]	→353
[Bluetooth]	→354
[Wireless Connection Lamp]	→354
[Beep]	→354
[Economy]	→355
[Monitor Display Speed]	→355
[LVF Display Speed]	→355
[Monitor Display]/[Viewfinder]	→356
[Monitor Luminance]/ [LVF Luminance]	→356
[Eye Sensor]	→356
[USB Mode]	→357
[TV Connection]	→357
[Language]	→358
[Version Disp.]	→358
[Folder / File Settings]	→359
[No.Reset]	→359
[Reset]	→359
[Reset Network Settings]	→359
[Pixel Refresh]	→359
[Level Gauge Adjust.]	→359
[Demo Mode]	→359
[Approved Regulations]	→359
[Format]	→359

 **[My Menu]**

[My Menu Setting]	→306
[Add]	→306
[Sorting]	→306
[Delete]	→306
[Display from My Menu]	→306





 **[Playback] menu**

[Slide Show]	→361
[Playback Mode]	→361
[Protect]	→362
[Rating]	→362
[Title Edit]	→363
[Face Rec Edit]	→364
[RAW Processing]	→364
[4K PHOTO Bulk Saving]	→364
[Light Composition]	→364
[Sequence Composition]	→364
[Clear Retouch]	→364
[Text Stamp]	→365
[Resize]	→366
[Cropping]	→367
[Rotate]	→367
[Video Divide]	→367
[Time Lapse Video]	→368
[Stop Motion Video]	→368
[Rotate Disp.]	→368
[Picture Sort]	→368
[Delete Confirmation]	→369
[Delete All Images]	→369

Menus displayed in specific recording modes

▶ : Default settings

[Intelligent Auto] menu

[Intelligent Auto Mode]	 / ▶ 	→77
	Switches between  mode and  mode.	
[iHandheld Night Shot]	[ON] / ▶ [OFF]	→79
	When the camera detects [iHandheld Night Shot], it records a still picture with less jitter and noise by combining multiple pictures.	
[iHDR]	[ON] / ▶ [OFF]	→79
	When the camera detects a contrast between the background and the subject, it records a still picture rich in gradation by combining multiple pictures.	

M [Creative Video] menu

[Exposure Mode]	▶ [P]/[A]/[S]/[M]	→244
	Sets the exposure mode to use in  mode.	
[4K Live Cropping]	[40SEC]/[20SEC]/▶ [OFF]	→247
	By cropping a part of the range displayed in the live view, it is possible to record an FHD video that incorporates panning and zooming with the camera staying in a fixed position.	

[Slow & Quick] menu

[S&Q Exposure Mode]	▶ [P]/[A]/[S]/[M]	→253
	Selects the exposure mode.	
[S&Q Recording Frame Rate]	[60p]/▶[30p]	→253
	Selects the recording frame rate.	
[S&Q Effect]	[8xQUICK]/[4xQUICK]/▶[2xQUICK]/[2xSLOW]/ [4xSLOW]	→254
	Select the speed effect.	

[Scene Guide] menu







[Scene Switch]	Displays the scene selection screen.	→105
----------------	--------------------------------------	------



[Creative Control] menu

[Filter Effect]	Displays the selection screen of filter effect.	→111
[Simultaneous Record w/o Filter]	[ON] /▶ [OFF]	→111
	Sets the camera to take a picture with and without an filter effect simultaneously.	

[Rec] Menu

-  : Menu items common to the [Rec] menu and [Motion Picture] menu.
Their settings are synchronized.
- ▶ : Default settings

[Aspect Ratio]	▶[4:3]/[3:2]/[16:9]/[1:1]		→117
	You can select the image aspect ratio.		
[Picture Size]	▶[L]/[M]/[S]		→118
	Sets the picture's image size.		
[Quality]	▶  /[RAW  /[RAW  /[RAW]		→119
	Set the compression rate used for storing pictures.		
 [Focus Mode]	▶[AFS]/[AFF]/[AFC]/[MF]		→124
	Selects the focusing method (focus mode) to match subject movement.		
[AF Sensitivity(Photo)]	[+2] to [-2] (▶ ±0)		→128
	Sets the tracking sensitivity for the movement of subjects.		
 [Photo Style]	▶[Standard]/[Vivid]/[Natural]/[Monochrome]/[L.Monochrome]/[L.Monochrome D]/[Scenery]/[Portrait]/[Custom]/[Cineline D]/[Cineline V]/[V-Log L]		→221
	You can select the finishing settings of images to suit your subjects and expression styles.		
 [Filter Settings]	[Filter Effect]	[ON]▶[OFF]/[SET]	→224
	[Simultaneous Record w/o Filter]	[ON]▶[OFF]	
	This mode records with additional image effects (filters).		

[Color Space]	▶[sRGB]/[AdobeRGB]	—
	 <p>This sets the method for correcting the color reproduction of the recorded images on the screens of a PC or on a device such as a printer.</p> <p>[sRGB]: This is widely used in PCs and similar devices.</p> <p>[AdobeRGB]: AdobeRGB is mainly used for business purposes such as professional printing because it has a greater range of reproducible colors than sRGB.</p> <ul style="list-style-type: none"> • Set to [sRGB] if you are not very familiar with AdobeRGB. • When the following functions are being used, the setting is fixed to [sRGB]: <ul style="list-style-type: none"> – Video recording, [4K PHOTO], [Post Focus] – [V-Log L] ([Photo Style]) – [Filter Settings] 	
 [Metering Mode]	▶[[☉]],[☉]],[☉]	→207
Type of optical measurement to measure brightness can be changed.		



[Highlight Shadow]

- ▶ [] ([Standard])/
- [] ([Higher contrast])/
- [] ([Lower contrast])/
- [] ([Brighten shadows])/
- [C1]/[C2]/[C3] (Custom)



You can adjust the highlights and shadows in a picture while confirming the brightness of these areas on the screen.





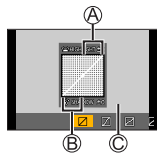



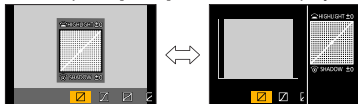



- Rotate to adjust the highlighted areas and rotate to adjust the shadowed areas. Press to confirm the setting.

- (A) Highlighted area
- (B) Shadowed area
- (C) Preview display







- Adjustments can also be made by dragging the graph.
- To register your preferred settings, press to select the registration target icon (Custom 1, Custom 2, and Custom 3).
- You can press [DISP.] to switch the display.







<p>[Highlight Shadow] (Continued)</p>	<ul style="list-style-type: none"> • When using [Filter Settings], [Highlight Shadow] is not available. • When [Photo Style] is set to [V-Log L], this is fixed to [] ([Standard]). • The settings adjusted in [], [], [], or [] will be restored to the default settings when the camera is turned off. 	<p>—</p>
<p> [i.Dynamic]</p>	<p>[AUTO]/[HIGH]/[STANDARD]/[LOW]▶[OFF]</p> <p>  PASM  S&Q  SCN </p> <p>Contrast and exposure are compensated when the brightness difference between the background and subject is great.</p> <ul style="list-style-type: none"> • Compensation effect may not be achieved depending on the recording conditions. • This function does not work in the following case: <ul style="list-style-type: none"> – When [HDR] is set to [ON] • When the following functions are being used, [i.Dynamic] is not available: <ul style="list-style-type: none"> – [V-Log L] ([Photo Style]) – [Filter Settings] – [Live View Composite] 	<p>—</p>
<p> [i.Resolution]</p>	<p>[HIGH]/[STANDARD]/[LOW]▶[OFF]</p> <p>  PASM  S&Q  SCN </p> <p>You can use the camera's Intelligent Resolution technology to record still pictures with sharper outlines and clearer resolution.</p>	<p>—</p>



[Flash]	[Flash Mode]	▶[⚡]/[⚡⊙]/[⚡S]/[+S⊙]/[⊙]	→227
	Sets the flash mode.		
	[Flash Synchro]	▶[1ST]/[2ND]	→232
	Sets the flash mode to Second Curtain Synchro.		
	[Flash Adjust.]	[-2 EV] to [+2 EV] ▶[±0 EV]	→231
	Adjusts the flash output if a picture taken using the flash is too bright or too dark.		
	[Auto Exposure Comp.]	[ON]/▶[OFF]	→233
	Automatically adjust the flash output in conjunction with the exposure compensation value.		
	[Wireless]	[ON]/▶[OFF]	→235
	Enables recording using a wireless flash.		
	[Wireless Channel]	▶[1CH]/[2CH]/[3CH]/[4CH]	→235
	Sets the channel to use when recording with a wireless flash.		
	[Communication Light]	▶[HIGH]/[STANDARD]/ [LOW]	→237
Set the strength of communication light.			
[Wireless Setup]	[External Flash] [A Group]/[B Group]/ [C Group]	→236	
Sets details for wireless flash recording.			



[Red-Eye Removal]	[ON]/▶[OFF]		→233
	When [Flash Mode] is set to [⚡⊙] or [⚡⊙], the camera automatically detects red-eye and corrects image data.		
[ISO Sensitivity (photo)]	[ISO Auto Lower Limit Setting]	▶[200] to [12800]	—
	[ISO Auto Upper Limit Setting]	▶[AUTO]/[400] to [25600]	
	 <p>You can set the upper limit of ISO sensitivity when ISO sensitivity is set to [AUTO] or [ISO].</p> <ul style="list-style-type: none"> When the following functions are being used, [ISO Sensitivity (photo)] is not available: <ul style="list-style-type: none"> [Clear Nightscape], [Cool Night Sky], [Warm Glowing Nightscape], [Handheld Night Shot] ([SCN] mode) 		
[Min. Shtr Speed]	▶[AUTO]/[1/16000] to [1/1]		—
	 <p>Sets the minimum value for the shutter speed to be used when ISO sensitivity is set to [AUTO] or [ISO].</p> <ul style="list-style-type: none"> The shutter speed may become slower than the set value in recording situations where correct exposure cannot be achieved. 		

<p>[Long Shtr NR]</p>	<p>▶[ON]/[OFF]</p>  <p>The camera automatically removes noise generated when recording images with a slow shutter speed.</p> <ul style="list-style-type: none"> • Recording is not possible during noise reduction. • When the following functions are being used, [Long Shtr NR] is not available: <ul style="list-style-type: none"> – Video recording, [4K PHOTO], [Post Focus] – [ESHTR] – [Silent Mode] 	<p>—</p>
<p>[Shading Comp.]</p>	<p>[ON]▶[OFF]</p>  <p>When the screen periphery darkens as a result of the lens characteristics, you can record pictures with the brightness of the screen periphery corrected.</p> <ul style="list-style-type: none"> • Compensation effect may not be achieved depending on the recording conditions. • Noise in the periphery of the picture may stand out with higher ISO sensitivity. • When the following functions are being used, [Shading Comp.] is not available: <ul style="list-style-type: none"> – Video recording, [4K PHOTO], [Post Focus] – Taking still pictures while a video is being recorded (when [Video Priority] is set) – [Ex. Tele Conv.] ([Rec]) – [Digital Zoom] 	<p>—</p>

 [Diffraction Compensation]	[AUTO]/▶[OFF]		—
 <p>The camera raises the image resolution by correcting the blurriness caused by diffraction when the aperture is closed.</p> <ul style="list-style-type: none"> • Compensation effect may not be achieved depending on the recording conditions. • Noise may stand out with higher ISO sensitivity. 			
 [Stabilizer]	[Operation Mode]	▶[[Hand icon]]/[Hand icon]/[OFF]	→204
[E-Stabilization (Video)]		[HIGH]/▶[STANDARD]/[OFF]	
Configures image stabilizer settings.			
[Ex. Tele Conv.] (Rec)	[ZOOM]/[TELE CONV.]/▶[OFF]		→152
You can take pictures that are further enlarged beyond what is available with the optical zoom, without any deterioration in image quality.			
 [Digital Zoom]	[2x]/▶[OFF]		→155
You can zoom in up to 2x the original zoom magnification.			
[Burst Rate]	▶[H]/[M]/[L]		→158
Sets the burst recording operation.			
[4K PHOTO]	[Rec Method]	[4K Burst (Wide-angle)] (In Self Shot Mode)/▶[4K Burst]/[4K Burst(S/S)]/[4K Pre-Burst]	→162
	[Pre-Burst Recording]	[ON]/▶[OFF]	
	Sets 4K photos. You can save pictures extracted from a burst file taken using high-speed burst.		

 [Self Timer]	▶[ 10]/[ 10]/[ 2]/[ 3] etc.		→185
	[SET]	2 sec. to 10 sec. (▶3 sec.)	
	Sets the self-timer duration.		
[Time Lapse Shot]	[Start]		→187
	[Shooting Interval Setting]	▶[ON]/[OFF]	
	[Start Time]	▶[Now]/[Start Time Set]	
	[Image Count] [Shooting Interval]		
	Starts/stops recording automatically at a set recording interval.		
[Stop Motion Animation]	[Start]		→190
	[Auto Shooting]	[ON]/▶[OFF]	
	[Shooting Interval]		
	Enables you to take pictures while moving the subject little by little.		
[Live View Composite]	[Start]		→101
	[Shutter Delay]	[8SEC]/[4SEC]/[2SEC]/ [1SEC]/▶[OFF]	
	The camera records images at set exposure time intervals, and combines parts with changes in bright light to save the result as one picture.		
[Silent Mode]	[ON]/▶[OFF]		→201
	Disables all operation sounds and light output at once.		
[Shutter Type]	▶[AUTO]/[EFC]/[ESHTR]		→202
	Selects the shutter type to use for taking pictures.		

[Shutter Delay]	<p>[8SEC]/[4SEC]/[2SEC]/[1SEC]/▶[OFF]</p>  <p>To reduce camera shake and shutter-induced blur, the shutter is released after the specified time has passed since the shutter button was pressed.</p> <ul style="list-style-type: none"> When the following functions are being used, [Shutter Delay] is not available: <ul style="list-style-type: none"> Video recording, [4K PHOTO], [Post Focus] [HDR] 	—
[Bracket]	<p>[Bracket Type] [⊕]/[⊖]/[FOCUS]/[WB] / ▶[OFF]</p> <p>[More Settings]</p> <p>You can take multiple pictures while automatically adjusting a setting.</p>	→ 195
[HDR]	<p>[ON]/▶[OFF]</p> <p>[SET] [Dynamic Range]</p> <p> [Auto Align]</p>  <p>The camera can combine 3 still pictures taken at different exposures into a single properly exposed picture with rich gradation. The individual pictures used to create the HDR picture are not saved. You can minimize the loss of gradations in bright areas and dark areas when, for example, the contrast between the background and the subject is large. A combined HDR picture is saved in JPEG format.</p> <p>[Dynamic Range]:</p> <p>[AUTO]: Takes pictures after automatically setting the adjustment range of the exposure based on the contrast of a subject.</p> <p>[±1EV] / [±2EV] / [±3EV]: Takes pictures using the adjustment range of the exposure being set.</p>	—

<p>[HDR] (Continued)</p>	<p>[Auto Align]: [ON]: Automatically adjusts the displacement of pictures caused by jitter, etc. We recommend using this setting to take pictures with a handheld camera. [OFF]: Does not adjust the displacement of pictures. We recommend using this setting when you use a tripod.</p> <ul style="list-style-type: none"> • After the shutter button has been pressed, do not move the camera during the burst operation. • Since a burst of still pictures are combined after they have been recorded, it will be a few moments before you will be able to record another picture. • A subject that was in motion when it was recorded may be recorded as an afterimage. • When [Auto Align] is set to [ON], the angle of view narrows slightly. • When you take pictures using a flash, the flash mode is fixed to  (Forced Flash Off). • This function will not work for still pictures while video are being recorded. • When the following functions are being used, [HDR] is not available: <ul style="list-style-type: none"> – Self Shot Mode – [Filter Settings] – [Burst] – [4K PHOTO], [Post Focus] – [Bracket] – [RAW , [RAW , [RAW] ([Quality]) – [Time Lapse Shot] – [Stop Motion Animation] (when [Auto Shooting] is set) – [Live View Composite] 	
--	--	--

[Multi Exp.]	[Start]	
	[Auto Gain]	▶[ON]/[OFF]
	[Overlay]	[ON]▶[OFF]
	 <p>You can apply an effect equivalent to four exposures on a single image.</p> <p>[Auto Gain]: Automatically adjusts brightness in accordance with image count.</p> <p>[Overlay]: Allows multiple exposure for recorded RAW images. After selecting [Start], a selection screen for images to stack is displayed.</p> <ul style="list-style-type: none"> • After selecting [Start], pressing the shutter button fully starts multiple exposure. • Preview is displayed for each recording, and the following operations are available: <ul style="list-style-type: none"> – [Next] (You can also perform the same operation by pressing the shutter button halfway.) – [Retake] – [Exit]: Records the picture, and finishes multiple exposure recording. 	

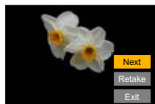



[Multi Exp.] (Continued)	<ul style="list-style-type: none">• To finish multiple exposure recording before starting the recording, press [Fn2] on the recording screen.• Recording information for the last-recorded image will be saved as recording information for images recorded with multiple exposures.• [Overlay] can be set only for RAW images recorded with the camera.• When the following functions are being used, [Multi Exp.] is not available:<ul style="list-style-type: none">– Self Shot Mode– [Filter Settings]– [Time Lapse Shot]– [Stop Motion Animation]– [Live View Composite]– HDMI output	—
-------------------------------------	--	---



















[Motion Picture] Menu

: Menu items common to the [Rec] menu and [Motion Picture] menu.
Their settings are synchronized.

▶: Default settings

[Rec Quality]	Sets the video recording image quality.	→239	
[Snap Movie]	[ON]/▶[OFF]	→255	
	[SET]		[Record time]
			[Pull Focus]
			[Fade]
	You can specify the recording time in advance and record videos casually like you take snapshots.		
 [Focus Mode]	▶[AFS]/[AFF]/[AFC]/[MF]	→124	
	Selects the focusing method (focus mode) to match subject movement.		
[Continuous AF]	▶[ON]/[OFF]	→259	
	You can select how to set the focus in AF when recording videos.		
[AF Custom Setting(Video)]	[ON]/▶[OFF]	→260	
	[SET]		[AF Speed]/[AF Sensitivity]
	You can fine-adjust the focusing method for video recording using [Continuous AF].		
 [Photo Style]	▶[Standard]/[Vivid]/[Natural]/[Monochrome]/[L.Monochrome]/[L.Monochrome D]/[Scenery]/[Portrait]/[Custom]/[Cineline D]/[Cineline V]/[V-Log L]	→221	
	You can select the finishing settings of images to suit your subjects and expression styles.		

 [Filter Settings]	[Filter Effect]	[ON]/▶[OFF]/[SET]	→224
	[Simultaneous Record w/o Filter]	[ON]/▶[OFF]	
This mode records with additional image effects (filters).			
[Luminance Level]	[0-255]/▶[16-255]		→261
	You can set the luminance range to suit the purpose of video recording.		
 [Metering Mode]	▶[☉]/[☺]/[☑]		→207
	Type of optical measurement to measure brightness can be changed.		
 [Highlight Shadow]	▶[☑] ([Standard])/[☑] ([Higher contrast])/[☑] ([Lower contrast])/[☑] ([Brighten shadows])/[☑1]/[☑2]/[☑3] (Custom)		→316
	You can adjust the highlights and shadows in a picture while confirming the brightness of these areas on the screen.		
 [i.Dynamic]	[AUTO]/[HIGH]/[STANDARD]/[LOW]/▶[OFF]		→317
	Contrast and exposure are compensated when the brightness difference between the background and subject is great.		
 [i.Resolution]	[High]/[Standard]/[Low]/▶[OFF]		—
	You can use the camera's Intelligent Resolution technology to record still pictures with sharper outlines and a clearer resolution.		
[ISO Sensitivity (video)]	[ISO Auto Lower Limit Setting]	▶[200] to [3200]	→262
	[ISO Auto Upper Limit Setting]	▶[AUTO]/[400] to [6400]	
	Sets the lower and upper limits for ISO sensitivity when ISO sensitivity is set to [AUTO].		

 [Diffraction Compensation]	[AUTO]▶[OFF] The camera raises the image resolution by correcting the blurriness caused by diffraction when the aperture is closed.	→321
 [Stabilizer]	[Operation Mode] ▶[[]]/[]/[OFF] [E-Stabilization (Video)] [HIGH]▶[STANDARD]/[OFF] Configures image stabilizer settings.	→204
[Flkr Decrease]	[1/50]/[1/60]/[1/100]/[1/120]▶[OFF]  The shutter speed can be fixed to reduce the flicker or striping in a video.	—
[Ex. Tele Conv.] ([Motion Picture])	[ON]▶[OFF] Fixes the zoom magnification at the maximum.	→154
 [Digital Zoom]	[2x]▶[OFF] You can zoom in up to 2x the original zoom magnification.	→155
[Picture Mode in Rec.]	▶[[]]/[] Select which setting to prioritize when taking pictures while a video is being recorded.	→243
 [Self Timer]	▶[[]]/[]/[]] etc. [SET] 2 sec. to 10 sec. (▶3 sec.) Sets the self-timer duration.	→185
[Sound Rec Level Disp.]	[ON]▶[OFF] The sound recording level is displayed on the recording screen.	→263
[Sound Rec Level Adj.]	▶[AUTO]/[MANUAL] ([MUTE], [-12dB] to [+6dB] (▶[0dB])) Sets the sound recording level.	→263

[Wind Noise Canceller]	[HIGH]▶[STANDARD]/[OFF]	→264
	This reduces the wind noise coming into the built-in microphone while maintaining sound quality.	
[Wind Cut]	[HIGH]/[STANDARD]/[LOW]▶[OFF]	→450
	This reduces wind noise when an external microphone is connected.	
[Lens Noise Cut]	▶[ON]/[OFF]	→264
	You can reduce the zoom sound produced during video recording when you are using interchangeable lens compatible with power zoom.	
[Built-in Mic]	[AUTO]▶[SURROUND]/[FRONT]/[TRACKING]/[BACK]	→265
	Sets the sound pickup range when using the built-in microphone.	
[Built-in Mic Indicator]	▶[ON]/[OFF]	→266
	Displays the sound pickup range and sound pickup target for the built-in microphone.	
[Special Mic.]	▶[STEREO]/[LENS AUTO]/[SHOTGUN]/[S.SHOTGUN]/[MANUAL]	→450
	Sets the sound pickup range when the Stereo Shotgun Microphone (DMW-MS2: optional) is connected.	

[Custom] Menu

▶ : Default settings

[Custom] menu ▶ [Exposure]

[ISO Increments]	▶[1/3EV]/[1 EV] Changes the intervals between ISO sensitivity adjustment values.
[Extended ISO]	[ON]▶[OFF] Extends the setting range of ISO sensitivity.
[Exposure Comp. Reset]	[ON]▶[OFF] This resets the exposure value when you change the recording mode or turn off the camera.

[Custom] menu ▶ [Focus / Release Shutter]

[AF/AE Lock]	▶[AE LOCK]/[AF LOCK]/[AF/AE LOCK]/[AF-ON] Sets which function is activated when [AF/AE LOCK] is assigned to an Fn button. (→210)
[AF/AE Lock Hold]	[ON]▶[OFF] This sets button operations for AF/AE Lock. Turning this [ON] maintains the lock after releasing the button until it is pressed again.
[Shutter AF]	▶[ON]/[OFF] This adjusts focus automatically when you press the shutter button halfway.
[Half Press Release]	[ON]▶[OFF] You can release the shutter quickly by pressing the shutter button halfway.







C/F [Custom] menu →  [Focus / Release Shutter]

[Quick AF]	<p data-bbox="332 186 459 209">[ON]/▶[OFF]</p> <p data-bbox="332 222 912 336">When the amount of camera shake becomes small, the camera will automatically adjust the focus and focus adjustment will then be quicker when the shutter button is pressed.</p> <ul data-bbox="332 346 871 460" style="list-style-type: none"> <li data-bbox="332 346 746 369">• The battery will drain faster than usual. <li data-bbox="332 375 871 460">• This function is not available in the following cases: <ul data-bbox="360 409 594 460" style="list-style-type: none"> <li data-bbox="360 409 550 432">– In preview mode <li data-bbox="360 438 594 460">– In low light situations 	
[Eye Sensor AF]	<p data-bbox="332 474 459 497">[ON]/▶[OFF]</p> <p data-bbox="332 511 881 566">When looking through the viewfinder, if the eye sensor operates, then AF will function.</p> <ul data-bbox="332 572 881 595" style="list-style-type: none"> <li data-bbox="332 572 881 595">• [Eye Sensor AF] may not work in low light situations. 	
[Pinpoint AF Setting]	[Pinpoint AF Time]	[LONG]/▶[MID]/[SHORT]
	[Pinpoint AF Display]	[FULL]/▶[PIP]
<p data-bbox="332 681 874 736">Changes enlarged screen settings displayed when AF mode is .</p> <p data-bbox="332 742 912 797">[Pinpoint AF Time]: Sets the time for which the screen is enlarged when the shutter button is pressed halfway.</p> <p data-bbox="332 803 936 859">[Pinpoint AF Display]: Sets the display method (full screen mode/windowed mode) of the enlarged screen.</p>		









C/F [Custom] menu →  [Focus / Release Shutter]

[AF Assist Lamp]	▶[ON]/[OFF]
	<p>When recording in low light conditions, the AF assist light turns on when you press the shutter button halfway, making it easier for the camera to focus.</p> <ul style="list-style-type: none"> • The effective range of the AF Assist Lamp is different depending on the lens used. <ul style="list-style-type: none"> – When the interchangeable lens (H-FS12032) is attached and at Wide: Approx. 1.0 m (3.3 feet) to 3.0 m (9.8 feet) • The AF Assist Lamp may be greatly blocked, and it may become harder to focus when a lens with large diameter is used. • When the following functions are being used, [AF Assist Lamp] is fixed to [OFF]: <ul style="list-style-type: none"> – [Distinct Scenery], [Bright Blue Sky], [Romantic Sunset Glow], [Vivid Sunset Glow], [Glistening Water], [Clear Nightscape], [Cool Night Sky], [Warm Glowing Nightscape], [Artistic Nightscape], [Handheld Night Shot] ([SCN] mode) – [Silent Mode]









 [Custom] menu →  [Focus / Release Shutter]

[Direct Focus Area]	[ON]/▶[OFF]	
	<p>Moves the AF area or MF assist using the cursor button while recording.</p> <ul style="list-style-type: none"> • When , , , or  is selected, you can move the AF area, when  is selected, you can move the lock start position, and when  is selected, you can move the focus position. • Perform the setting of functions assigned to the cursor buttons using the Quick menu (→299) or function buttons (→293). • When the following functions are being used, [Direct Focus Area] is fixed to [OFF]: <ul style="list-style-type: none"> – [Glistening Water] ([SCN] mode,  mode) – [4K Live Cropping] 	
[Focus/Release Priority]	[AFS]/[AFF]	▶[FOCUS]/[BALANCE]/[RELEASE]
	[AFC]	[FOCUS]/▶[BALANCE]/[RELEASE]
	<p>This sets whether to give priority to focus or shutter release during AF.</p> <p>[FOCUS]: Disables recording when focus is not achieved.</p> <p>[BALANCE]: Performs recording while controlling the balance between focusing and shutter release timing.</p> <p>[RELEASE]: Enables recording even when focus is not achieved.</p>	

 [Custom] menu ➔  [Focus / Release Shutter]

[Focus Switching for Vert / Hor]	<p>[ON]/▶[OFF]</p> <p>This stores separate AF area positions for when the camera is held vertically and when it is held horizontally. The camera memorizes two different vertical positions, one with the camera's right side facing down and one with the left side facing down.</p> <ul style="list-style-type: none"> • This function works when the AF mode is set to , , or . • In MF, this memorizes the MF Assist position.
[Loop Movement Focus Frame]	<p>[ON]/▶[OFF]</p> <p>When moving the AF area or MF Assist, this enables its position to loop from one edge to the other edge of the screen.</p>
[AF Area Display]	<p>▶[ON]/[OFF]</p> <p>You can perform the AF area display setting when the AF Mode is set to  (49-area-focusing) or Custom Multi.</p> <p>[ON]: Displays the AF area on the recording screen.</p> <ul style="list-style-type: none"> • When the default AF area is selected in  (49-area-focusing) or , , or  of Custom Multi-function, the AF area is not displayed. <p>[OFF]: Displays the AF area on the recording screen for only a few seconds after the AF area is set.</p> <ul style="list-style-type: none"> • When the following functions are being used, even when it is set to [ON], it has the same operations as [OFF]. <ul style="list-style-type: none"> –  mode, [S&Q] mode – Video recording, [4K PHOTO]





















C/F [Custom] menu → **[FOCUS]** **[Focus / Release Shutter]**

[AF+MF]	[ON]/▶[OFF] You can fine-adjust the focus manually during AF Lock. – When focus mode is [AFS], and the shutter button is pressed halfway – When locked using the Fn button [AF LOCK] or [AF/AE LOCK]	
[MF Assist]	When an interchangeable lens with a focus ring is attached	 /▶  /[]/[OFF]
	When an interchangeable lens with no focus ring is attached	▶[ON]/[OFF]
	This sets the display method of MF Assist (enlarged screen). [] : The screen is enlarged by operating the lens or by pressing [] (◀). [] : The screen is enlarged by operating the lens. [] : The screen is enlarged by pressing [] (◀). • While you are using the following functions, MF Assist will not be displayed: – Video recording – [4K Pre-Burst] – [Digital Zoom]	
[MF Assist Display]	[FULL]/▶[PIP] This sets the display method (full screen mode/windowed mode) of MF Assist (enlarged screen).	





 [Custom] menu ➔  [Operation]

[Fn Button Set]	[Setting in REC mode]
	[Setting in PLAY mode]
	Registers a function to the Fn button. <ul style="list-style-type: none"> For details, refer to page 293.
[ISO Displayed Setting]	[Front Dial] ▶ [ISO]/[ISO LIMIT]/[OFF]
	This sets the operations of the dials in the setting screen for ISO sensitivity. Assigning [ISO LIMIT] lets you change [ISO Auto Upper Limit Setting].
[Exposure Comp. Disp. Setting]	[Cursor Buttons (Up/Down)] [⬆️]/▶[OFF]
	This sets the operations of the ▲ ▼ in the exposure compensation screen. Assigning [⬆️] lets you set exposure bracketing.
	[Front Dial] ▶ [⬆️]/[⚡]/[OFF]
	This sets the operations of the dials in the exposure compensation screen. Assigning [⚡] lets you adjust flash output.
[Q.MENU]	▶[PRESET]/[CUSTOM]
	Customizes the Quick menu. <ul style="list-style-type: none"> For details, refer to page 299.

 [Custom] menu ➔  [Operation]

[Dial Set.]	[Assign Dial (F/SS)]	▶[ F  SS]/[ SS  F]
	Sets the operations to be assigned to the dials in [M] mode.	
	[ F  SS]: Assigns the aperture value to the front dial, and the shutter speed to the control dial.	
	[ SS  F]: Assigns the shutter speed to the front dial, and the aperture value to the control dial.	
	[Rotation (F/SS)]	▶[ ]/[ ]
	Changes the rotational directions of the dials for aperture value and shutter speed adjustment.	
[Exposure Comp.]	[]/[]▶[OFF]	
Assigns exposure compensation to  or  .		
(Except in [M] mode)		
[Dial Operation Switch Setup]	[]	
	[]	
In the Fn button [Dial Operation Switch], this sets the functions to be registered temporarily to  or  . (➔297)		

 [Custom] menu ➔  [Operation]

[Operation Lock Setting]	[Cursor]	▶[ON]/[OFF]
	[Touch Screen]	▶[ON]/[OFF]
	[Dial]	▶[ON]/[OFF]
	<p>You can set an object for which operation is disabled when [Operation Lock] is assigned to the function button using [Fn Button Set] (➔293) in the [Custom] ([Operation]) menu.</p> <p>[Cursor]: Cursor buttons and </p> <p>[Touch Screen]: Touch screen</p> <p>[Dial]: , and </p>	
[Focus Ring Lock]	[ON]▶[OFF]	<p>(When an interchangeable lens with a focus ring is attached)</p> <p>This disables the focus ring operation during MF to lock the focus.</p> <ul style="list-style-type: none"> • [MFL] is displayed on the recording screen while the focus ring is locked.
[Video Rec. Button]	▶[ON]/[OFF]	Enabling/disabling the video rec. button.
[Touch Settings]	[Touch Screen]	▶[ON]/[OFF]
	[Touch Tab]	▶[ON]/[OFF]
	[Touch AF]	▶[AF]/[AF+AE]
	[Touch Pad AF]	▶[EXACT]/ [OFFSET1] to [OFFSET7]/[OFF]
	<p>Enables touch operation on the monitor display.</p> <p>[Touch Screen]: All touch operations.</p> <p>[Touch Tab]: Operations of tabs, such as  on the right side of the screen.</p> <p>[Touch AF]: Operation to optimize the focus ([AF]) for a touched subject. Alternatively, operation to optimize both the focus and brightness ([AF+AE]). (➔142)</p> <p>[Touch Pad AF]: Touch pad operation during viewfinder display. (➔144)</p>	















 [Custom] menu ➔  [Monitor / Display]

	[Duration Time (photo)]	[HOLD]/[5SEC] to [1SEC] (▶[2SEC])/[OFF]
	[Duration Time (4K PHOTO)]	▶[HOLD]/[OFF]
	[Duration Time (Post Focus)]	▶[HOLD]/[OFF]
	[Playback Operation Priority]	[ON]/▶[OFF]
[Auto Review]	<p>This displays an image immediately after it is recorded.</p> <p>[Duration Time (photo)]: Sets the Auto Review when taking pictures.</p> <p>[Duration Time (4K PHOTO)]: Sets the Auto Review when recording 4K photos.</p> <p>[Duration Time (Post Focus)]: Sets the Auto Review when recording with Post-Focus.</p> <p>[Playback Operation Priority]: When this is set to [ON], you can toggle the playback screen during Auto Review, or delete pictures.</p> <ul style="list-style-type: none"> • If you set [Duration Time (photo)] to [HOLD], the image recorded stays displayed until the shutter button is pressed halfway. [Playback Operation Priority] will be fixed to [ON]. 	
[Monochrome Live View]	[ON]/▶[OFF]	<p>You can display the recording screen in black and white. This is convenient for focusing with MF.</p> <ul style="list-style-type: none"> • The image outputted via HDMI will not be displayed in black and white.

 [Custom] menu ➔  [Monitor / Display]

	[ON]▶[OFF]
	[SET] [Preview While MF Assist]
[Constant Preview]	<p>You can always confirm the effects of aperture and shutter speed on the recording screen when in [M] mode. Preview also operates in the MF Assist screen when [Preview While MF Assist] is set to [ON].</p> <ul style="list-style-type: none"> This function does not work when using the flash.
	[MODE1]/[MODE2]▶[OFF]
	[SET] [P/A/S/M]▶[M]
[Live View Boost]	<p>Displays the screen brighter to make it easier to check subjects and compositions even in low-light environment.</p> <p>[MODE1]: Setting for low brightness, with priority given to a soft display.</p> <p>[MODE2]: Setting for high brightness, with priority given to image visibility.</p> <ul style="list-style-type: none"> You can change the recording mode in which [Live View Boost] works by using [SET]. This mode does not affect recorded images. Noise may be more noticeable in the screen than in the recorded image. This function does not work in the following cases: <ul style="list-style-type: none"> When adjusting the exposure (when the shutter button is pressed halfway, for example) When recording a video or 4K photo When using [Filter Settings] When using [Constant Preview]

 [Custom] menu →  [Monitor / Display]

[Peaking]	▶[ON]/[OFF]	
	[SET]	[Detect Level]
		[Display Color]
	<p>During MF operation, in-focus portions (portions on the screen with clear outlines) are highlighted with color.</p> <ul style="list-style-type: none"> • When [Detect Level] in [SET] is set to [HIGH], portions to be highlighted are reduced, allowing you to achieve a more precise focus. • Changing the [Detect Level] setting also changes the [Display Color] setting as follows. 	
	[Detect Level]	[HIGH] ←→ [LOW]
		 (Light blue)  (Blue)
		 (Yellow)  (Orange)
	[Display Color]	 (Yellow Green)  (Green)
		 (Pink)  (Red)
		 (White)  (Gray)
<ul style="list-style-type: none"> • Each time  in  is touched, the setting is switched in order of  ([Detect Level]: [LOW]) →  ([Detect Level]: [HIGH]) → [OFF]. • When [Rough Monochrome] of  mode is being used, [Peaking] is not available. • When [Live View Boost] is being used, [Peaking] is not available. 		



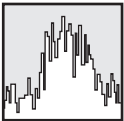



☞ [Custom] menu ➔ [Monitor / Display]

[Histogram]	<div style="background-color: #d9e1f2; padding: 2px; margin-bottom: 5px;">[ON]▶[OFF]</div> <p>This displays the histogram.</p> <p>Turning this [ON] displays the histogram transition screen.</p> <p>Press ▲▼◀▶ to set the position.</p> <ul style="list-style-type: none"> • You can also move the position by dragging the histogram on the recording screen. • A histogram is a graph that displays brightness along the horizontal axis, and the number of pixels at each brightness level on the vertical axis. By looking at the distribution of the graph, you can determine the current exposure. <div style="float: right; text-align: center; margin-top: 10px;">  </div> <ul style="list-style-type: none"> (A) Dark (B) Bright • When the recorded image and the histogram do not match each other under the following conditions, the histogram is displayed in orange: <ul style="list-style-type: none"> – During exposure compensation – When the flash fires – When the correct exposure is not achieved, such as in low light situations. • The histogram is an approximation in the recording mode.
[Guide Line]	<div style="background-color: #d9e1f2; padding: 2px; margin-bottom: 5px;">[Grid 1]/[Grid 2]/[Grid 3]▶[OFF]</div> <p>Sets the grid line pattern to be displayed on the recording screen.</p> <p>When using [Grid 1], you can press ▲▼◀▶ to set the position.</p> <ul style="list-style-type: none"> • When using [Grid 3], you can also drag [Grid 3] on the grid lines on the recording screen to move the position.

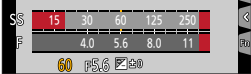





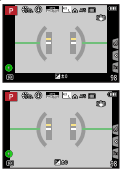



☞ [Custom] menu ➔  [Monitor / Display]

[Frame Marker]	[ON]/▶[OFF]	
	[SET]	[Frame Aspect]
		[Frame Color]
		[Frame Mask]
<p>A frame with the set aspect ratio is displayed on the recording screen.</p> <ul style="list-style-type: none"> • For details, refer to page 268. 		
[Center Marker]	[ON]/▶[OFF]	
<p>The center of the recording screen will be displayed as [+].</p>		
[Highlight]	[ON]/▶[OFF]	
	<p>Overexposed areas appear blinking in black and white during Auto Review or playback.</p>  <ul style="list-style-type: none"> • The display without the highlights is added to the display shown when [DISP.] is pressed in the playback screen. Use this to delete the highlight display. (➔60) 	
[Zebra Pattern]	[ZEBRA1]/[ZEBRA2]/▶[OFF]	
	[SET]	[Zebra 1]
		[Zebra 2]
<p>Parts that are brighter than the benchmark value are displayed with stripes.</p> <ul style="list-style-type: none"> • For details, refer to page 267. 		

[Custom] menu → [Monitor / Display]

[Expo.Meter]	<p>[ON]/▶[OFF]</p> <p>This displays the exposure meter.</p>  <ul style="list-style-type: none"> • Set to [ON] to display the exposure meter when performing Program Shift, setting aperture, and setting shutter speed. • If no operations are performed for a certain period of time, the exposure meter disappears.
[MF Guide]	<p>▶[ON]/[OFF]</p> <p>During MF, MF Guide, which acts as a guide to recording distance, is displayed on the screen.</p>
[LVF/Monitor Disp. Set]	<p>[LVF Disp. Set]  / ▶ </p>
	<p>[Monitor Disp. Set]  / ▶ </p> <p>You can switch the viewfinder/monitor display method.</p> <p>: Display the icons outside of the live view area.</p> <p>: Display the icons within the live view area.</p> 
[Monitor Info. Disp.]	<p>▶[ON]/[OFF]</p> <p>Displays the monitor recording information screen.</p>

 [Custom] menu ➔  [Monitor / Display]

[Rec Area]	<p>▶  / </p> <p>Switching the angle of view setting used for recording still pictures and video.</p> <p>: Indicated as the angle of view when recording still pictures.</p> <p>: Indicated as the angle of view when recording video.</p> <ul style="list-style-type: none"> • The recording area indicated is an approximation. • [Rec Area] is fixed to  when recording 4K photos or recording in [Post Focus].
[Remaining Disp.]	<p>▶ :  (Remaining Shots) / :  (Remaining Time)</p> <p>Switching the display between the number of recordable pictures that you can take and the available recording time.</p>
[Red REC Frame Indicator]	<p>▶ [ON]/[OFF]</p> <p>A red frame is displayed on the recording screen that indicates that video is being recorded.</p>
[Menu Guide]	<p>▶ [ON]/[OFF]</p> <p>You can display the selection screen when the mode dial is switched to [SCN] / .</p>

 [Custom] menu ➔  [Lens / Others]

[Lens Position Resume]	<p>[ON]/▶[OFF]</p> <p>The camera saves the focus position when you turn it off. When an interchangeable lens that is compatible with power zoom is in use, the zoom position is also saved.</p>
[Power Zoom Lens]	[Disp Focal Length] ▶[ON]/[OFF]
	[Step Zoom] [ON]/▶[OFF]
	[Zoom Speed] [Photo] [H]/▶[M]/[L]
	[Video] [H]/▶[M]/[L]
[Lens Fn Button Setting]	[Zoom Ring] ▶[ON]/[OFF]
	<p>Sets the screen display and operation when using an interchangeable lens compatible with power zoom. (➔ 156)</p> <p>▶[Focus Stop]/[AF/AE LOCK]/[AF-ON]/[Stabilizer]/[Focus Area Set]/[AF Mode/MF]/[Preview]/[Focus Ring Lock]/[Off]/[Restore to Default]</p> <p>Sets the function to be assigned to the focus button of an interchangeable lens.</p> <ul style="list-style-type: none"> You can call up the assigned function by setting the focus selector switch of a compatible interchangeable lens to [Fn] and then pressing the focus button of the lens. When [Focus Stop] is used, the focus is locked while the focus button is pressed and held.

 [Custom] menu ➔  [Lens / Others]

[Aperture Ring Increment]	<p>[SMOOTH]▶[1/3EV]</p> <p>[SMOOTH]: You can finely adjust the aperture value. [1/3EV]: You can adjust the aperture value in increments of 1/3 EV.</p> <p>You can change the aperture adjustment increment by operating the aperture ring.</p> <ul style="list-style-type: none"> • This setting is available when an interchangeable lens that supports a click-less aperture ring (optional: H-X1025) is attached (as of June 2020). • When taking pictures, this setting will take effect if the aperture ring is set to a position other than [A]. • If the position of the aperture ring is set to [A], the aperture value set by the camera will take effect and can be adjusted like with [1/3EV]. • During video recording, fine adjustments can be made like with [SMOOTH]. • When [SMOOTH] is set, fractions of aperture values are not displayed on the screen.
[Self Timer Auto Off]	<p>▶[ON]/[OFF]</p> <p>The self-timer is canceled if the unit is turned off.</p>
[Self Shot]	<p>▶[ON]/[OFF]</p> <p>If you set [Self Shot] to [OFF], the mode will not switch to Self Shot Mode (➔83) even if you rotate the monitor.</p>
[AF After Countdown]	<p>▶[ON]/[OFF]</p> <p>The camera focuses automatically after the self-shot countdown ends.</p>





[Custom] menu → [Lens / Others]

[ON]/▶[OFF]/[MEMORY]

The Face Recognition function recognizes a face similar to a registered face and automatically adjusts focus and exposure for the face with higher priority.

Registering face pictures

Up to 6 people's face pictures can be registered along with such information as name and birthdate.

- 1 Use ▼ to select [MEMORY] and press .
- 2 Use ▲▼◀▶ to select [New] and press .
- 3 Align the face with the guide and record.
 - Faces of subjects other than people (e.g. pets) cannot be registered.
 - When ▶ is pressed or  is touched, an explanation is displayed.
- 4 Use ▲▼ to select the item for editing and press .

[Name]: Set the name.

 - For details on how to enter characters, refer to "Entering Characters" (→370)

[Age]: Set the birthdate.

[Add Images]: Up to 3 face pictures of the person can be registered.





- ① Use ◀▶ to select [Add] and press .
 - When a registered face picture is selected with cursor button, a screen to confirm deletion is displayed. Select [Yes] to delete the face picture.
- ② Record the picture. (step 3)



[Face Recog.]

 [Custom] menu →  [Lens / Others]

[Face Recog.]
 (Continued)

Editing or deleting information about registered persons

- 1 Use ▼ to select [MEMORY] and press .
- 2 Use ▲▼◀▶ to select the picture of the person to be edited or deleted and press .
- 3 Use ▲▼ to select the item and press .
 - [Info Edit]:** Edit name or other registered information. (Step 4 of "Registering face pictures")
 - [Priority]:** Set priority order for focus and exposure.
 - ① Use ▲▼◀▶ to select the registration order and press .
 - [Delete]:** Delete information and face pictures of registered persons.





- In some cases, the camera cannot recognize or incorrectly recognizes even registered people depending on their expression or the environment.
- [Face Recog.] functions only when AF mode is set to .
- Only the first picture of the burst recording will contain Face Recognition information.
- The name of the person recognized in the first picture is displayed in the case of group pictures.
- When the following functions are being used, [Face Recog.] is not available:
 - [Slimming Mode] (Self Shot Mode)
 - [Slimming Mode] in [Clear Portrait] ([SCN] mode)
 - [Miniature Effect] ([] mode)
 - Video recording, [4K PHOTO], [Post Focus]
 - [Time Lapse Shot]
 - [Multi Exp.]

[Custom] menu → [Lens / Others]

[ 1]/[ 2]/[]/▶/[OFF] / [SET]

The name and age of the baby/pet are recorded to the image.

Setting the name and age in months/years

- 1 Use ▼ to select [SET] and press .
- 2 Use ▲ ▼ to select [Baby1], [Baby2] or [Pet] and press .
- 3 Use ▲ ▼ to select [Age] or [Name] and press .
- 4 Use ▼ to select [SET] and press .
Enter the [Age].
Enter the [Name].
 - For details on how to enter characters, refer to “Entering Characters” (→370)

Canceling the display of the name and age in months/years







Set [Profile Setup] to [OFF].

- [Name] and [Age] print settings can be made on your computer using “PHOTOfunSTUDIO” software, which you download from a website. Text may also be stamped onto the still picture using the camera’s [Text Stamp].
- When the following functions are being used, [Profile Setup] is not available:
 - [4K PHOTO], [Post Focus]
- You cannot record the name or age in months/years in the following cases:
 - During video recording
 - Still pictures that are taken while recording video

[Profile Setup]

[Setup] Menu

▶ : Default settings







[Online Manual]	<p>[URL display]/[QR Code display]</p> <p>Displays the URL or QR code in order to download the "Owner's Manual" (PDF format).</p>
[Cust.Set Mem.]	<p>[C1]/[C2]/[C3]</p> <p>You can register the currently set information of the camera.</p> <ul style="list-style-type: none"> For details, refer to page 303.
[Clock Set]	<p>Sets the date and time.</p> <ul style="list-style-type: none"> For details, refer to page 45.
[World Time]	<p>[] [Destination]</p> <p>▶ [] [Home]</p>
	<p>Sets the times for the region where you live and your travel destination.</p> <ul style="list-style-type: none"> You can set [Destination] after setting [Home]. <ol style="list-style-type: none"> Use ▲ ▼ to select [Destination] or [Home] and press . Use ◀ ▶ to select area and press . <p>When [Home] has been selected.</p> <div style="display: flex; align-items: flex-start;"> <div style="margin-right: 20px;"> <p>Ⓐ Current time</p> <p>Ⓑ Time difference from GMT (Greenwich Mean Time)</p> </div>  </div> <ul style="list-style-type: none"> If you are using Daylight Savings [], press ▲. (The time will move forward by 1 hour.) To return to the normal time, press ▲ again. When you come back from your travel destination, select [Home] in step 1 and press .

	[Travel Setup]	[SET]/▶[OFF]
	[Location]	[SET]/▶[OFF]
[Travel Date]	<p>[Travel Setup]: If you set your travel schedule and record pictures, the day of your trip on which the picture was taken will be recorded.</p> <p>[Location]: Once the [Travel Setup] is set, you can set the location.</p> <ul style="list-style-type: none"> • For details on how to enter characters, refer to “Entering Characters”. (→370) • To print [Location] or the number of days that have passed, either use [Text Stamp] (→365) or print using the “PHOTOfunSTUDIO” software. • The travel date is calculated from the set departure date and the date set in the camera’s clock. When destination is set in [World Time], days elapsed are calculated based on local destination time. • When [Travel Setup] is set to [OFF], the number of days elapsed is not recorded. It is not displayed even if [Travel Setup] is set to [SET] after recording. • When the current date passes the return date, [Travel Setup] is automatically canceled. • [Location] cannot be recorded while recording video, recording 4K photos, or recording in [Post Focus]. 	
	[Wi-Fi]	[Wi-Fi Function] (→371)
[Wi-Fi Setup] (→427)		

[Bluetooth]	[Bluetooth] (→375)	
	[Send Image (Smartphone)] (→407)	
	[Remote Wakeup] (→396)	
	[Returning from Sleep Mode] (→390)	
	[Auto Transfer] (→393)	
	[Location Logging] (→395)	
	[Auto Clock Set] (→397)	
	[Wi-Fi network settings]	
[Wi-Fi network settings]: Registers the Wi-Fi access point. Wireless access points used to connect the camera to Wi-Fi networks will be registered automatically.		
[Wireless Connection Lamp]	▶[ON]/[OFF]	
	The lamp lights while the wireless function is operating.	
[Beep]	[Beep Volume]	[] (High)/▶[] (Low)/[] (Off)
	[Shutter Vol.]	[] (High)/▶[] (Low)/[] (Off)
	[Shutter Tone]	▶[①] (Pattern 1)/[②] (Pattern 2)/[③] (Pattern 3)
	Sets the beep sounds and electronic shutter sounds. <ul style="list-style-type: none"> • When [Silent Mode] is being used, [Beep Volume] and [Shutter Vol.] are fixed to Off. 	

[Economy]	[Sleep Mode]	[10MIN.]/▶[5MIN.]/[2MIN.]/[1 MIN.]/[OFF]
	[Sleep Mode(Wi-Fi)]	▶[ON]/[OFF]
	[Auto LVF/Monitor Off]	▶[5MIN.]/[2MIN.]/[1 MIN.]/[OFF]
	[Power Save LVF Shooting]	[Time]
		[Display]
<p>This is a function to automatically turn the camera to sleep (power save) status or turn off the viewfinder/monitor if no operation is performed for a set time.</p> <ul style="list-style-type: none"> • For details, refer to page 37. 		
[Monitor Display Speed]	[ECO 30fps]/▶[60fps]	
	<p>Sets the display speed for live view on the monitor.</p> <p>[ECO 30fps]: Reduces the power consumption for a longer operating time.</p> <p>[60fps]: Enables smooth display of movements.</p> <ul style="list-style-type: none"> • When the following functions are being used, [Monitor Display Speed] is not available: <ul style="list-style-type: none"> – [M] mode, [S&Q] mode – Video recording, [4K PHOTO], [Post Focus] – HDMI output 	
[LVF Display Speed]	[ECO 30fps]/▶[60fps]	
	<p>Sets the display speed for live view on the viewfinder.</p> <p>[ECO 30fps]: Reduces the power consumption for a longer operating time.</p> <p>[60fps]: Enables smooth display of movements.</p> <ul style="list-style-type: none"> • When the following functions are being used, [LVF Display Speed] is not available: <ul style="list-style-type: none"> – [M] mode, [S&Q] mode – Video recording, [4K PHOTO], [Post Focus] – HDMI output 	

[Monitor Display]/ [Viewfinder]	[Brightness]/[Contrast]/[Saturation]/[Red Tint]/[Blue Tint]	
	<p>This adjusts the brightness, coloring, and red or blue tints of the monitor/viewfinder.</p> <ol style="list-style-type: none"> Press ▲ ▼ to select the setting item, and press ◀ ▶ to adjust. Press  to confirm the setting. <ul style="list-style-type: none"> It will adjust the monitor when the monitor is in use, and the viewfinder when the viewfinder is in use. 	
[Monitor Luminance]/ [LVF Luminance]	▶[AUTO]/[-3] to [+3]	
	<p>Adjusts monitor/viewfinder luminance.</p> <p>[AUTO]: The brightness is adjusted automatically depending on how bright it is around the camera.</p> <ul style="list-style-type: none"> Adjusts the monitor luminance when displaying the monitor, and the viewfinder luminance when displaying the viewfinder. When either [AUTO] is set, or the adjusted value is set to positive side, the usage period will shorten. 	
[Eye Sensor]	[Sensitivity]	▶[HIGH]/[LOW]
	This will set the sensitivity of the eye sensor.	
	[LVF/Monitor Switch]	▶[LVF/MON AUTO] (automatic viewfinder/monitor switching)/ [LVF] (viewfinder)/[MON] (monitor)
<p>This will set the method for switching between the viewfinder and monitor.</p> <ul style="list-style-type: none"> If you press [LVF] to switch the display, the [LVF/Monitor Switch] setting will also switch. 		

[USB Mode]	▶[ ,] [Select on connection]/[] [PC(Storage)]/ [] [PictBridge(PTP)]
[TV Connection]	<p>This sets the communication method to be used when the USB connection cable is connected.</p> <p>[,] [Select on connection]: Select this setting to select the USB communication system when connecting to another device.</p> <p>[] [PC(Storage)]: Select this setting to export images to a connected PC.</p> <p>[] [PictBridge(PTP)]: Select this setting when connecting to a printer that supports PictBridge.</p> <hr/> <p>[HDMI Mode (Play)] ▶[AUTO]/[4K/30p]/[1080p]/[1080i]/ [720p]/[480p]</p> <p>Sets the HDMI output resolution for playback.</p> <p>[AUTO]: Outputs with a resolution suited to the connected TV.</p> <ul style="list-style-type: none"> • If no image appears on the TV with [AUTO], switch to a constant setting other than [AUTO] to set a format supported by your TV. (Refer to the operating instructions for the TV.)

[TV Connection] (Continued)	[HDMI Info Display (Rec)]	▶[MODE1]/[MODE2]/[OFF]
	<p>Sets the camera's information display that will be outputted to the external device connected via HDMI.</p> <p>[MODE1]: This constantly outputs the information display.</p> <p>[MODE2]: This outputs the information display for 5 seconds when the camera is operated.</p> <p>[OFF]: This does not output the information display.</p> <ul style="list-style-type: none"> • When set to [OFF], only the following switches/buttons are enabled. <ul style="list-style-type: none"> – Camera on/off switch – Shutter button – Video rec. button – [▶] button 	
[Language]	[VIERA Link]	[ON]/▶[OFF]
[Version Disp.]	<p>You can use the device remote control to operate the camera when it is connected to a VIERA Link compatible device using an HDMI micro cable.</p> <ul style="list-style-type: none"> • For details, refer to page 435. <p>This set the language displayed on the screen.</p> <ul style="list-style-type: none"> • If you set a different language by mistake, select [Ⓜ] from the menu icons to set the desired language. <p>You can check the firmware versions of the camera and lens.</p> <p>Press  to display information about the camera software.</p>	



[Folder / File Settings]	<p>[Select Folder]/[Create a New Folder]/[File Name Setting]</p> <p>Set the folder and file name where to save the images.</p> <ul style="list-style-type: none"> • For details, refer to page 121.
[No.Reset]	<p>Resets the file number of the next recording to 0001.</p> <ul style="list-style-type: none"> • For details, refer to page 123.
[Reset]	<p>Returns the camera to its default settings.</p> <ul style="list-style-type: none"> • For details, refer to page 67.
[Reset Network Settings]	<p>Network settings are reset to the default, such as equipment information you have registered using [Wi-Fi Setup] or [Bluetooth]. (Excluding [LUMIX CLUB])</p>
[Pixel Refresh]	<p>This optimizes the image sensor and image processing.</p> <ul style="list-style-type: none"> • The image sensor and image processing are optimized when the camera is purchased. Use this function when bright spots that do not exist in the subject get recorded. • Turn the camera off and on after the pixels are corrected.
[Level Gauge Adjust.]	<p>[Adjust.]</p> <p>Hold the camera in a horizontal position, and press . The level gauge will be adjusted.</p>
	<p>[Level Gauge Value Reset]</p> <p>Restores the default level gauge setting.</p>
[Demo Mode]	<p>You can try focusing, peaking, etc. in [Post Focus], with the image picture.</p>
[Approved Regulations]	<p>Displays the certification number for radio regulations.</p>
[Format]	<p>Formats the card (initialization).</p> <ul style="list-style-type: none"> • For details, refer to page 40.

[Playback] Menu

❖ How to Select an Image(s) in the [Playback] menu



Follow the steps below when the image selection screen is displayed.

When [Single] has been selected

- 1 Press ◀▶ to select the image.
- 2 Press .
 - If [Set/Cancel] is displayed at the right bottom of the screen, the setting is canceled when  is pressed again.





When [Multi] has been selected

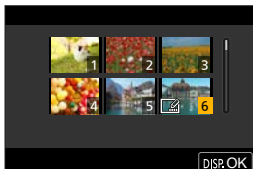



- 1 Press ▲▼◀▶ to select the image and then press  (repeat).
 - The setting is canceled when  is pressed again.
- 2 Press [DISP.] to execute.



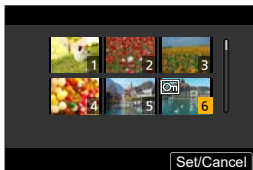



When a screen similar to the one on the right is displayed:





- Press ▲▼◀▶ to select the image, and then press  to set (repeat).
- The setting is canceled when  is pressed again.



▶ : Default settings	
[Slide Show]	<p>[ALL]/[Picture Only]/[Video Only]</p> <p>Selects image types and plays them back at regular intervals in order.</p> <p>[Start]: Starts slide show playback.</p> <p>[Effect]: Allows you to select the screen effects when switching from one picture to the next.</p> <p>[Setup]: [Duration]/[Repeat]/[Sound]</p> <p>[Duration]: Sets the duration to play an image. [Duration] can be set only when [Effect] is set to [OFF].</p> <p>[Repeat]: Sets repeat playback.</p> <p>[Sound]: If you select [AUTO], music will be played for still pictures, and audio will be played for videos. You can also select a setting to play just one of the two or neither.</p> <p>Operations during slide show</p> <p>▲ : Plays/pauses. You can also perform the same operation by touching .</p> <p>◀ : Move to the previous image</p> <p>▶ : Move to the next image</p> <p>▼ : Ends the slide show</p> <p> : Adjusts the volume You can also perform the same operation by touching  or .</p> <ul style="list-style-type: none"> • When [Video Only] is set, [Duration] is not available.
	[Playback Mode]







[Protect]	[Single]/[Multi]/[Cancel]
	<p>You can set protection for images so that they will not be deleted by mistake.</p> <p>However, if you format the card, the protected images will also be deleted.</p> <ul style="list-style-type: none"> • For information about how to select images, refer to page 360. • Be careful because the [Protect] setting may be disabled on a device other than this camera.
[Rating]	[Single]/[Multi]/[Cancel]
	<p>If you set any of the five different rating levels for images, you can do the following:</p> <ul style="list-style-type: none"> • Deleting all images except for those with ratings. • Check the rating level in the file details display in operating systems such as Windows 10, Windows 8.1, and Windows 8. (JPEG images only) <ol style="list-style-type: none"> 1 Select an image. (→360) 2 Press ◀▶ to select a rating level (1 to 5) and then press . <ul style="list-style-type: none"> • When [Multi] is selected, repeat Steps 1 and 2. • To cancel the setting, set the rating level to [OFF].



[Title Edit]	<p>You can enter characters (titles etc.) on a recorded picture. After text has been registered, it can be stamped in prints using [Text Stamp] (→365).</p> <ol style="list-style-type: none">1 Select a still picture (→360).<ul style="list-style-type: none">•  is displayed for pictures with texts already stamped.2 Enter characters.<ul style="list-style-type: none">• For details on how to enter characters, refer to “Entering Characters” (→370).• To delete texts, delete all the characters in the character input screen. <ul style="list-style-type: none">• You can print out texts using the “PHOTOfunSTUDIO” software.• You can set up to 100 pictures at one time with [Multi].• [Title Edit] is not available for images recorded using the following functions:<ul style="list-style-type: none">– Video recording, [4K PHOTO], [Post Focus]– [RAW , [RAW , [RAW] ([Quality])
---------------------	---

[Face Rec Edit]	<p>[REPLACE]/[DELETE]</p> <p>Edit or delete the recognition information for pictures with incorrect information.</p> <ol style="list-style-type: none"> 1 Use ◀▶ to select picture and press . 2 Use ◀▶ to select a person and press . <ul style="list-style-type: none"> • If [DELETE], go to step 4. 3 Use ▲▼◀▶ to select the person to replace for another and press . 4 Use ◀ to select [Yes] and press . <ul style="list-style-type: none"> • When Face Recognition information is deleted, it cannot be restored.
[RAW Processing]	<p>Processes pictures taken in RAW format on the camera and saves them in JPEG format.</p> <ul style="list-style-type: none"> • For details, refer to page 286.
[4K PHOTO Bulk Saving]	<p>You can save any 5 second period of pictures from a 4K burst file all at once.</p> <ul style="list-style-type: none"> • For details, refer to page 175.
[Light Composition]	<p>Select multiple frames from 4K burst files that you wish to combine. Parts of the image that are brighter than the preceding frame will be superimposed on the preceding frame to combine the frames into one picture.</p> <ul style="list-style-type: none"> • For details, refer to page 280.
[Sequence Composition]	<p>Selects multiple frames from a 4K burst file to create a sequence composition of a moving subject into one picture.</p> <ul style="list-style-type: none"> • For details, refer to page 282.
[Clear Retouch]	<p>Erases unnecessary parts recorded on the pictures taken.</p> <ul style="list-style-type: none"> • For details, refer to page 284.



[Text Stamp]

You can stamp the recording date and time, names, travel destination, travel dates, etc. on the recorded still pictures.

- 1 Select a still picture (→ 360).
 -  is displayed on the screen if the picture is already stamped with [Text Stamp].
- 2 Select the content to stamp.
 - Use ▼ to select [Set] and press .
 - [Shooting Date]:** [W/O TIME] (recording date)/ [WITH TIME] (recording date and time)
 - [Name]:**  (Name registered in Face Recognition)/ (Name registered in [Profile Setup])
 - [Location]:** Location registered in [Setup] menu's [Travel Date]
 - [Travel Date]:** Number of days that have elapsed since the travel date set in [Setup] menu's [Travel Date]
 - [Title]:** Text registered in [Title Edit]
- 3 Press .
- 4 Use ▲ to select [OK] and press .
 - **Do not request date printing in store or make date printing on printer for still pictures with date stamps. (Date printing may be overlapped.)**
 - You can set up to 100 pictures at one time with [Multi].
 - The picture quality may be coarser.
 - [Text Stamp] is not available for images recorded using the following functions:
 - Video recording, [4K PHOTO], [Post Focus]
 - [RAW] ([Quality])
 - [Text Stamp]
 - Date information cannot be stamped on images recorded without setting the clock.

[Resize]	[Single]/[Multi]
	<p>Reduce the picture size of JPEG images and save them as different images to enable them to be easily used for web pages or sent as email attachments.</p> <ul style="list-style-type: none">• For information about how to select images, refer to page 360.<ul style="list-style-type: none">– When [Single] is selected, after choosing the image, press ▲▼ to select the size, then press .– When [Multi] is selected, before choosing the images, press ▲▼ to select the size, then press .• You can set up to 100 images at once with [Multi].• The image quality of the resized image becomes lower.• [Resize] is not available for images recorded using the following functions:<ul style="list-style-type: none">– Video recording, [4K PHOTO], [Post Focus]– Group images– [RAW] ([Quality])– [Text Stamp]

[Cropping]	<p>Enlarge your still pictures and crop unwanted areas.</p> <ol style="list-style-type: none"> 1 Use to select a still picture and press . 2 Select area to crop and press . <p>Operations during cropping</p> <p>: Enlarges/reduces the screen. You can also perform the same operation by touching [-]/[+].</p> <p> : Moves the enlarged area. You can perform the same operation by dragging on the screen.</p> <ul style="list-style-type: none"> • Original Face Recognition information will not be copied when still pictures are cropped. • Picture quality is reduced after cropping. • Edit group pictures one by one. • [Cropping] is not available for images recorded using the following functions: <ul style="list-style-type: none"> – Video recording, [4K PHOTO], [Post Focus] – [RAW] ([Quality]) – [Text Stamp]
[Rotate]	<p>Rotate images manually in 90° steps.</p> <p>[]: Rotates 90° clockwise.</p> <p>[]: Rotates 90° counter-clockwise.</p> <ul style="list-style-type: none"> • For information about how to select images, refer to page 360.
[Video Divide]	<p>Divide a recorded video or 4K burst file into two.</p> <ul style="list-style-type: none"> • For details, refer to page 290.







[Time Lapse Video]	<p>This creates videos from group images recorded with [Time Lapse Shot].</p> <ol style="list-style-type: none"> 1 Press ◀▶ to select a group images recorded with [Time Lapse Shot] and then press . 2 Select the options for creating a video to combine the pictures into a video. <ul style="list-style-type: none"> • For details, refer to page 193.
[Stop Motion Video]	<p>This creates videos from group images recorded with [Stop Motion Animation].</p> <ol style="list-style-type: none"> 1 Press ◀▶ to select a group images recorded with [Stop Motion Animation] and then press . 2 Select the options for creating a video to combine the pictures into a video. <ul style="list-style-type: none"> • For details, refer to page 193.
[Rotate Disp.]	<p>▶[ON]/[OFF]</p> <p>Automatically displays pictures vertically if they were recorded when holding the camera vertically.</p>
[Picture Sort]	<p>[FILE NAME]/▶[DATE/TIME]</p> <p>This sets the order in which the camera displays images during playback.</p> <p>[FILE NAME]: Displays images by folder name/file name. [DATE/TIME]: Displays images by recording date.</p> <ul style="list-style-type: none"> • If you insert another card, it may take some time to read all data, therefore pictures may not be displayed in the set order.

[Delete Confirmation]	<p data-bbox="332 147 564 171">["Yes" first]/▶["No" first]</p> <p data-bbox="332 180 914 267">This sets which option, [Yes] or [No], will be highlighted first when the confirmation screen for deleting an image is displayed.</p> <p data-bbox="332 275 710 299">["Yes" first]: [Yes] is highlighted first.</p> <p data-bbox="332 307 693 331">["No" first]: [No] is highlighted first.</p>
[Delete All Images]	<p data-bbox="332 343 669 368">[Delete All]/[Delete All Non-rating]</p> <p data-bbox="332 377 619 401">Deletes all images in a card.</p> <p data-bbox="332 409 750 433">[Delete All]: Deletes all images in a card.</p> <p data-bbox="332 441 907 496">[Delete All Non-rating]: Deletes all images except those with a rating set.</p> <ul data-bbox="332 503 938 681" style="list-style-type: none"> <li data-bbox="332 503 917 559">• [Delete All] can be used when [Playback Mode] is set to [Normal Play]. <li data-bbox="332 566 933 621">• Images cannot be restored once they have been deleted. Carefully confirm the images before deletion. <li data-bbox="332 628 938 681">• Depending on the number of images to be deleted, it may take some time to delete them.

Entering Characters

Follow the steps below when the character entry screen is displayed.

1 Enter characters.

- Press ▲▼◀▶ to select characters and then press  until the character to enter is displayed.
(Repeat this)
- To repeatedly enter the same character, rotate  or  to the right to move the entry position cursor.
- If you select an item and press , you can perform the following operations:
 - []: Change the character type to [A] (upper case characters), [a] (lower case characters), [1] (numbers), and [&] (special characters)
 - []: Enter a blank
 - [Delete]: Delete a character
 - [<]: Move the entry position cursor to the left
 - [>]: Move the entry position cursor to the right



2 Complete entering.

- Select [Set] and then press .



- A maximum of 30 characters can be entered (maximum of 9 characters when setting names in [Face Recog.]).
- A maximum of 15 characters can be entered for [\], [[], []], [•] and [—] (maximum of 6 characters when setting names in [Face Recog.]).

14. Wi-Fi/Bluetooth

This chapter explains the Wi-Fi® and Bluetooth® functions of the camera.

Remote Operations from a Smartphone



You can use the "LUMIX Sync" for remote recording and image transfers.

→373

Transferring Images from This Camera



Send recorded images to a device connected via Wi-Fi by operating the camera.

→400

This document refers to both smartphones and tablets as **smartphones**.

❖ Checking operation of the Wi-Fi and Bluetooth functions

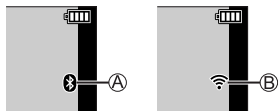

- Ⓐ The Bluetooth function is set to on, or there is a connection
(The Wi-Fi icon will be displayed when a function connecting to Wi-Fi is used after Bluetooth connection, such as [Auto Transfer].)
- Ⓑ The Wi-Fi function is set to on, or there is a connection

When image data is sent using a camera operation, [📶] is displayed on the monitor.

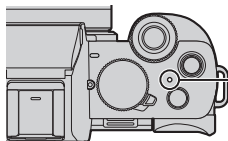

WIRELESS connection lamp (Blue)

Lit: When the Wi-Fi/Bluetooth function is ON or connected.

Blinking: When sending picture data.





- Do not remove the card or battery or move to an area without any reception while sending images.
- The camera cannot be used to connect to a public wireless LAN connection.
- We strongly recommend that you set an encryption to maintain information security.
- We recommend that you use a sufficiently charged battery when sending images.
- When the remaining battery level is low, it may not be possible to connect to or maintain communication with other devices.
(A message such as [Communication error] is displayed.)
- Images may not be completely sent depending on radio wave conditions. If the connection is terminated while sending images, images with parts that cannot be displayed may be sent.

Connecting to a Smartphone

You can perform remote recording and transfer images using the smartphone app “Panasonic LUMIX Sync” (hereinafter referred to as “LUMIX Sync”).

Flow of connecting a smartphone

1	Install “LUMIX Sync” on your smartphone. (→374)	
2	Connect to a smartphone.	
	Using a smartphone that supports Bluetooth Low Energy • Bluetooth connection (→375)	Using a smartphone that does not support Bluetooth Low Energy • Wi-Fi connection (→380)
3	Operate the camera using the smartphone. (→386) <ul style="list-style-type: none"> • [Remote shooting] (→387) • [Shutter Remote Control] (→389) • [Import images] (→391) • [Auto Transfer] (→393) • [Location Logging] (→395) • [Remote Wakeup] (→396) • [Auto Clock Set] (→397) 	
	 	

- You can also use the camera to transfer images to a smartphone. (→400)

Installing “LUMIX Sync”

“LUMIX Sync” is an application for smartphones provided by Panasonic.

Supported OS

Android™: Android 5 or higher

iOS: iOS 11 or higher

- 1** Connect the smartphone to a network.
- 2** (Android) Select “Google Play™ Store”.
(iOS) Select “App Store”.
- 3** Enter “Panasonic LUMIX Sync” or “LUMIX” into the search box.
- 4** Select and install the “Panasonic LUMIX Sync” .

-  Use the latest version.
- Supported OSs are current as of June 2020 and are subject to change.
- Read the [Help] in the “LUMIX Sync” menu for further details on how to operate.
- The app may not operate correctly depending on your smartphone.
For information on the “LUMIX Sync”, refer to the following support site:
<https://panasonic.jp/support/global/cs/dsc/>
(English only)

Connecting to a Smartphone (Bluetooth Connection)

Follow a simple connection setup procedure (pairing) to connect to a smartphone that supports Bluetooth Low Energy.

When pairing is set up, the camera also automatically connects to the smartphone via Wi-Fi.

- For the first-time connection, pairing settings are required.

For information about connecting for the second and subsequent times, refer to page 378.

Supported smartphones

Android™: Android 5 or higher with Bluetooth 4.0 or higher
(excluding those that do not support Bluetooth Low Energy)

iOS: iOS 11 or higher

- Turn on the smartphone's Bluetooth function in advance.

1 On the smartphone, start up "LUMIX Sync".

- A message regarding device (camera) registration is displayed. Select [Next].
- If you have closed the message, select [?], then register the camera using [Camera registration (pairing)].

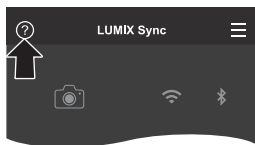
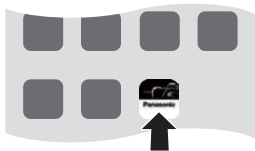

2 Check the content in the displayed guide and select [Next] until the screen to register the camera is displayed.

Operating the camera in accordance with the smartphone guide.

3 Set the camera to Bluetooth pairing standby state.

- **MENU/SET** ⇒ [**🔧**] ⇒ [Bluetooth] ⇒ [Bluetooth] ⇒ [SET] ⇒ [Pairing]
- The camera enters pairing standby state and the device name **A** is displayed.



4 On the smartphone, select the camera's device name.

- (iOS devices) When a message to confirm the change of destination is displayed, select [Join].

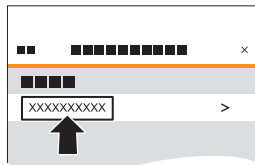

5 When a message indicating that device registration is complete, select [OK].

- A Bluetooth connection between the camera and the smartphone will be made.

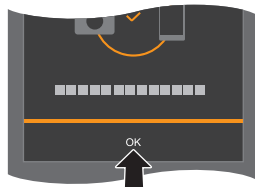



- The paired smartphone is registered as a paired device.
- During Bluetooth connection, [Bluetooth icon] is displayed in the recording screen. When the Bluetooth function is enabled, but a connection is not established with the smartphone, [Bluetooth icon] appears translucent.
- Up to 16 smartphones can be registered. If you try to register more than 16 smartphones, the registration information will be deleted from the oldest first.

❖ End Bluetooth Connection

To terminate the Bluetooth connection, turn off the Bluetooth function of the camera.



⇒ [Wrench icon] ⇒ [Bluetooth] ⇒ [Bluetooth] ⇒ Select [OFF]



- Even if you terminate the connection, the pairing information for it will not be deleted.

❖ Connecting to a Paired Smartphone

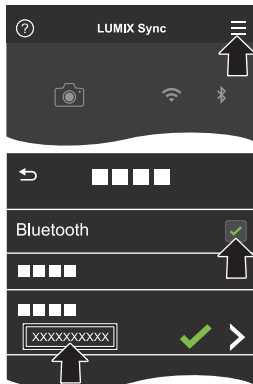

Connect paired smartphones using the following procedure.

- ① Enable the Bluetooth function of the camera.
 - **MENU/SET** ⇒ [**Wrench**] ⇒ [Bluetooth] ⇒ [Bluetooth] ⇒ [ON]
- ② On the smartphone, start up “LUMIX Sync”.
 - If a message is displayed indicating that the smartphone is searching for cameras, close the message.
- ③ Select [**≡**].
- ④ Select [Bluetooth Setup].
- ⑤ Turn Bluetooth ON.
- ⑥ From [Camera registered] items, select the camera's device name.



- Even if you set up pairing with more than one smartphone, you can only connect to one smartphone at a time.
- When pairing takes some time, canceling the pairing settings on both the smartphone and camera and re-establishing the connection may result in the camera being detected correctly.

❖ Canceling Pairing

- 1 Cancel the pairing setting of the camera.
 -  ⇒ [] ⇒ [Bluetooth] ⇒ [Bluetooth] ⇒ [SET] ⇒ [Delete]
- 2 Select the smartphone for which to cancel the pairing.



- Also cancel the pairing setting on the smartphone.
- When [Reset Network Settings] in the [Setup] menu is used to reset the network settings, the information for registered devices is deleted.



Connecting to a Smartphone (Wi-Fi connection)

Use Wi-Fi to connect the camera and a smartphone.

With default settings, simple connection with smartphones is possible without entering a password.

You can also use password authentication for enhanced connection security.

1 Set the camera to Wi-Fi connection standby status.

-  →  → [Wi-Fi] → [Wi-Fi Function] → [New Connection] → [Remote Shooting & View]
- The SSID  of the camera is displayed on the screen.
- You can also perform the same operation by pressing the Fn button assigned with [Wi-Fi].
For information about the Fn button, refer to page [292](#).



2 In the setting menu of the smartphone, turn the Wi-Fi function ON.

3 Select the SSID displayed on the camera.

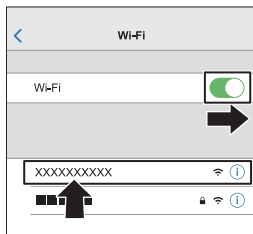

- 4** On the smartphone, start up “LUMIX Sync”.

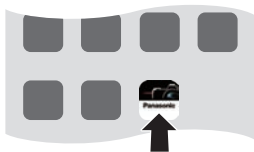

- 5** (At the first connection)
Confirm the device name displayed on the camera and then select [Yes].



- When a device different than the one you want to connect to is displayed, the camera will automatically connect to that device if you select [Yes]. If there are other Wi-Fi connection devices nearby, we recommend using either QR code or manual password input to connect with password authentication. (→382)

❖ Using Password Authentication to Connect

You can enhance Wi-Fi connection security by using password authentication through either QR code or manual input.

Scanning QR code to connect

① Set [Wi-Fi Password] on the camera to [ON].

- **MENU/SET** ⇒ [**Wi-Fi**] ⇒ [Wi-Fi] ⇒ [Wi-Fi Setup] ⇒ [Wi-Fi Password] ⇒ [ON]

② Display the QR code **A**.

- **MENU/SET** ⇒ [**Wi-Fi**] ⇒ [Wi-Fi] ⇒ [Wi-Fi Function] ⇒ [New Connection] ⇒ [Remote Shooting & View]
- You can also perform the same operation by pressing the Fn button assigned with [Wi-Fi].
For information about the Fn button, refer to page 292.
- Press **MENU/SET** to enlarge the QR code.



③ On the smartphone, start up “LUMIX Sync”.

- If a message is displayed indicating that the smartphone is searching for cameras, close the message.

④ Select [**≡**].

⑤ Select [Wi-Fi connection].

⑥ Select [QR code].

⑦ Scan the QR code displayed on the screen of the camera using “LUMIX Sync”.

- (iOS devices) When a message to confirm the change of destination is displayed, select [Join].

Manually entering a password to connect

- 1 Display the screen in Step 2 on page 382.
- 2 In the setting menu of the smartphone, turn the Wi-Fi function ON.

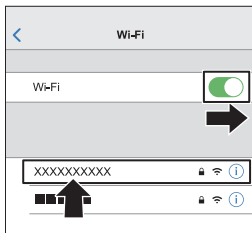

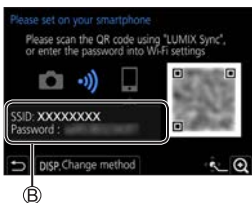

- 3 On the Wi-Fi setup screen, select the SSID (B) displayed on the camera.
- 4 (At the first connection) Enter the password (B) displayed on the camera.
- 5 On the smartphone, start up "LUMIX Sync".



❖ Connection Methods Other Than the Default Settings

When connecting with [Via Network], or [WPS Connection] in [Direct], follow the steps below:

- 1 Display the connection method setting screen for the camera.
 -  ⇒  ⇒ [Wi-Fi] ⇒ [Wi-Fi Function] ⇒ [New Connection] ⇒ [Remote Shooting & View]
- 2 Press [DISP].

Connecting via network

- 1 Select [Via Network] and then press .
 - Follow the connection method on page [418](#) to connect the camera to a wireless access point.
- 2 In the setting menu of the smartphone, turn the Wi-Fi function ON.
- 3 Connect the smartphone to the wireless access point that the camera is connected to.
- 4 On the smartphone, start up "LUMIX Sync".

Connecting directly

- 1 Select [Direct] and then press .
 - Select [WPS Connection], and follow the connection method on page [421](#) to connect the camera to a smartphone.
- 2 On the smartphone, start up "LUMIX Sync".

Terminating the Wi-Fi Connection

To end the Wi-Fi connection between the camera and smartphone, follow the steps below.

1 Set the camera to recording mode.

- Press the shutter button halfway.

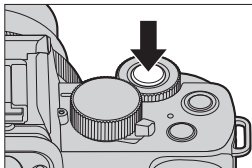

2 Terminate the Wi-Fi connection.

- **MENU/SET** → [**Wi-Fi**] → [Wi-Fi Function] → [Yes]

- You can also perform the same operation by pressing the Fn button assigned with [Wi-Fi].

For information about the Fn button, refer to page [292](#).



3 On the smartphone, close the “LUMIX Sync”.

Operating the Camera with a Smartphone

This explains the functions for operating the camera from a smartphone. Functions described in this document with the (Bluetooth) symbol require a smartphone that supports Bluetooth Low Energy.





Getting started:

- Connect the camera to a smartphone. (→375, 380)
- On the smartphone, start up “LUMIX Sync”.

❖ Home Screen

When you start up “LUMIX Sync”, the home screen is displayed.



<p>(A) </p>	<p>App settings (→378, 382, 396) This allows connection settings, camera power operations, and displays Help.</p>
<p>(B) </p>	<p>[Import images] (→391)</p>
<p>(C) </p>	<p>[Remote shooting] (→387)</p>
<p>(D) </p>	<p>[Shutter Remote Control] (→389)</p>

[Remote shooting]

You can use the smartphone to record from a remote location while viewing the live view images from the camera.

1 Select [📱📷] ([Remote shooting]) in the home screen.

- (iOS devices) When a message to confirm the change of destination is displayed, select [Join].

2 Start recording.

Ⓐ	Takes a picture
Ⓑ	Starts/ends the video recording

- The recorded image is saved on the camera.

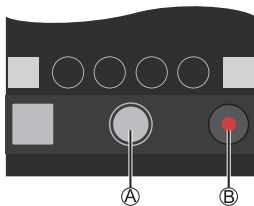



- Certain features, including some settings, may not be available.

❖ Operation Method During Remote Recording

Set either the camera or the smartphone as the priority control device to be used during remote recording.

 ⇒ [] ⇒ [Wi-Fi] ⇒ [Wi-Fi Setup] ⇒ Select [Priority of Remote Device]

 [Camera]	<p>Operation is possible on both the camera and the smartphone.</p> <ul style="list-style-type: none"> • The camera's dial settings, etc. cannot be changed with the smartphone.
 [Smartphone]	<p>Operation is possible only on the smartphone.</p> <ul style="list-style-type: none"> • The camera's dial settings, etc. can be changed with the smartphone. • To end remote recording, press any of the buttons on the camera to turn on the screen, and select [End].

- The default setting is [Camera].



- The setting of this function cannot be changed while the connection is active.



[Shutter Remote Control]

Bluetooth

You can use the smartphone as a remote control for the shutter.

1 Select [] ([Shutter Remote Control]) in the home screen.

2 Start recording.

	Starts/ends the video recording
	Takes a picture <ul style="list-style-type: none"> • Bulb recording (→389)



❖ Bulb Recording



The shutter can be kept open from the start to end of recording, which is useful for recording of starry skies or night scenery.

Getting started:

- Set the camera to [M] mode. (→98)
- Set the camera shutter speed to [T] (Time). (→100)

1 Touch [] to start recording (keep touching, without removing your finger).

2 Remove your finger from [] to end recording.

- Slide [] in the direction of [LOCK] to record with the shutter button locked in a fully-pressed state.
(Slide [] back to its original position or press the camera shutter button to end recording)
- During [B] (Bulb) recording, if the Bluetooth connection is broken, then carry out Bluetooth connection again, then end recording from the smartphone.



❖ Shortening the Return Time from [Sleep Mode]

You can shorten the time it takes for the camera to return from [Sleep Mode] when the [Shutter Remote Control] is used.

Getting started:

- Set [Remote Wakeup] in [Bluetooth] to [ON]. (→396)

 ⇒ [] ⇒ [Bluetooth] ⇒ Select [Returning from Sleep Mode]

	[Import / Remote Priority]	Shortens the time to return when using [Import images] or [Remote shooting].
	[Shutter Remote Priority]	Shortens the time to return when using [Shutter Remote Control].

- To use the [Shutter Remote Control] to cancel [Sleep Mode] on the camera, set [Bluetooth] in the [Setup] menu as follows, then connect via Bluetooth:
 - [Remote Wakeup]: [ON] (→396)
 - [Auto Transfer]: [OFF] (→393)
- The camera cannot be turned on by using [Shutter Remote Control].

[Import images]

Transfer an image stored on the card to the smartphone connected via Wi-Fi.

1 Select [📷] ([Import images]) in the home screen.

- (iOS devices) When a message to confirm the change of destination is displayed, select [Join].

2 Select the image to transfer.

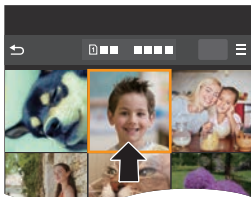

3 Transfer the image.

- Select [📷].
- If the image is a video, you can play it back by touching [▶] at the center of the screen.

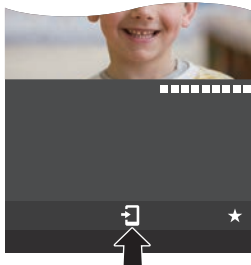



- When a video is played back, this has a small data size and is transmitted using “LUMIX Sync”, therefore its image quality will differ from that of the actual video recording.

Depending on the smartphone and on the usage conditions, the image quality may deteriorate or the sound may skip during video or picture playback.

- Files larger than 4 GB cannot be sent.
- Images recorded using the following functions cannot be transferred:
 - [4K PHOTO], [Post Focus]

[Auto Transfer]

Bluetooth

You can automatically transfer recorded pictures to a smartphone as they are taken.

1 Enable [Auto Transfer] on the camera.

- **MENU/SET** ⇒ [**🔧**] ⇒ [Bluetooth] ⇒ [Auto Transfer] ⇒ [ON]
- If a confirmation screen is displayed on the camera asking you to terminate the Wi-Fi connection, select [Yes] to terminate it.



2 On the smartphone, select [Yes] (for Android devices) or [Join] (for iOS devices).

- The camera automatically makes a Wi-Fi connection.

3 Check the send settings on the camera and then press **MENU/SET**.

- To change the send setting, press [DISP]. (→424)
- The camera will enter a mode where it can automatically transfer images and [**📶**] will be displayed on the recording screen.

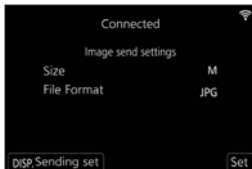

4 Record with the camera.

- [**📶**] is displayed in the recording screen of the camera while a file is being sent.

❖ To Stop the Automatic Transfer of Images

 → [] → [Bluetooth] → [Auto Transfer] → Select [OFF]

- A confirmation screen is displayed, asking you to terminate the Wi-Fi connection.



- If the [Bluetooth] and [Auto Transfer] settings of the camera are [ON], the camera automatically connects to the smartphone via Bluetooth and Wi-Fi when you turn on the camera.

Start up the “LUMIX Sync” on the smartphone to connect to the camera.



- When [Auto Transfer] is set to [ON], [Wi-Fi Function] cannot be used.
- If the camera is turned off during image transfer, and the file sending is interrupted, then turn on the camera to restart the sending.
 - If the storage status of unsent files changes, then sending of files may no longer be possible.
 - If there are many unsent files, then sending of all files may not be possible.
- Images recorded with the following functions cannot be transferred automatically:
 - Video recording, [4K PHOTO], [Post Focus]

[Location Logging]



Bluetooth

The smartphone sends its location information to the camera via Bluetooth, and the camera performs recording while writing the acquired location information.

Getting started:

- Enable the GPS function on the smartphone.

1 Enable [Location Logging] on the camera.

-  ⇒  ⇒ [Bluetooth] ⇒ [Location Logging] ⇒ [ON]
- The camera will enter a mode where location information can be recorded and [GPS] is displayed in the recording screen of the camera.

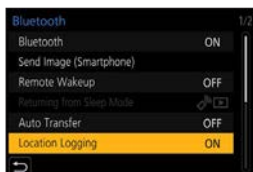

2 Record images with the camera.

- Location information will be written to the recorded images.





- When [GPS] on the recording screen appears translucent, location information cannot be acquired, therefore data cannot be written. Smartphone GPS positioning may not be possible if the smartphone is within a building, a bag, or similar. Move the smartphone to a position affording a wide view of the sky to improve positioning performance. In addition, refer to the operating instructions of your smartphone.
- Images with location information are indicated with [GPS].
- Be sure to pay special attention to the privacy, the likeness rights, etc. of the subject when you use this function. Use at your own risk.
- The smartphone drains its battery faster while acquiring location information.

[Remote Wakeup]

Bluetooth

Even when the camera is turned off, the smartphone can be used to start the camera and record images, or check the recorded images.

Getting started:

- 1 Enable [Remote Wakeup] on the camera.
 -  ⇒  ⇒ [Bluetooth] ⇒ [Remote Wakeup] ⇒ [ON]
- 2 Set the camera on/off switch to [OFF].
- 3 On the smartphone, start up “LUMIX Sync”.

❖ Turning On the Camera

Select [Remote shooting] in the “LUMIX Sync” home screen.

- (iOS devices) When a message to confirm the change of destination is displayed, select [Join].
- The camera turns on, and automatically connects using Wi-Fi.

❖ Turning Off the Camera

- 1 Select [- 2 Select [Turn off the camera].
- 3 Select [Power OFF].





- When [Remote Wakeup] has been set, the Bluetooth function continues to work even if the camera on/off switch is set to [OFF], so the battery will drain.

[Auto Clock Set]

Bluetooth

Synchronize the clock and the time zone setting of the camera with those of a smartphone.

Enable [Auto Clock Set] on the camera.

-  ⇒  ⇒ [Bluetooth] ⇒ [Auto Clock Set] ⇒ [ON]

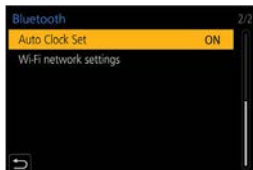

Displaying still pictures on a TV

You can display still pictures on a TV that is compatible with a DLNA (DMR) function.

1 Select [Playback on TV].

- **MENU/SET** → [] → [Wi-Fi] → [Wi-Fi Function] → [New Connection] → [Playback on TV]

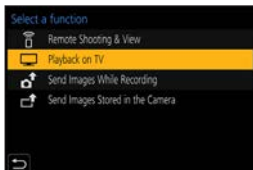

2 Connect the camera to the TV via Wi-Fi.

- Select [Via Network] (→418) or [Direct] (→421) to connect.

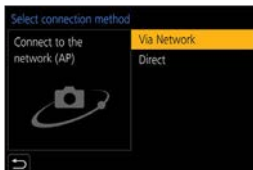

3 Select the device you wish to connect to.

4 Take or play back still pictures on this unit.

- To end the connection, follow the steps below:
MENU/SET → [] → [Wi-Fi] → [Wi-Fi Function] → [Yes]







- When you display the pictures on a TV using the Wi-Fi function, they are not output using 4K resolution. To output pictures using 4K resolution, connect this unit to the TV using an HDMI micro cable. (→434)
- When a TV is connected to this unit, the TV screen may temporarily return to the status before the connection. Pictures are displayed again when you take or play back pictures.
- Even if [Effect] and [Sound] are set on this unit, these settings are disabled when the pictures are played back on a TV during Slide Show playback.
- Video and 4K burst files cannot be played back.
- The pictures displayed on "Multi Playback" screen or some screens of the camera are not displayed on the TV.
- When [Auto Transfer] in the [Bluetooth] is set to [ON], [Wi-Fi Function] is disabled.

Sending Images from the Camera

Operate the camera to send recorded images to a device connected by Wi-Fi.

Operation flow

1	<p>Select the sending method.</p> <p>Select the sending method from the [Send Images While Recording] and [Send Images Stored in the Camera] camera menus.</p>	
2	<p>Select the destination (type of the destination device).</p> <ul style="list-style-type: none"> - [Smartphone] (→404) - [PC] (→407) - [Printer] (→410) - [AV device] (→412) - [Web service] (→414) - [Cloud Sync. Service] (→416) 	
3	<p>Select the connection method and then connect by Wi-Fi.</p> <ul style="list-style-type: none"> - [Via Network] (→418) - [Direct] (→421) 	
4	<p>Check the send settings.</p> <ul style="list-style-type: none"> - Image send settings (→424) 	
5	<p>[Send Images While Recording]</p> <p>Take pictures.</p> <p>This automatically sends the recorded pictures as they are taken.</p>	<p>[Send Images Stored in the Camera]</p> <p>Select an image.</p> <p>Send the selected images.</p>

Refer to the following pages for the steps common to all devices.

- Wi-Fi connections: [Via Network] (→418)/[Direct] (→421)
- Image send settings (→424)
- Selecting images (→426)



- When recording, recording is prioritized so it will take time for sending to complete.
- If the camera is turned off, or the Wi-Fi is disconnected before sending is completed, then sending will not restart.
- You may not be able to delete files or use the [Playback] menu while sending.
- The camera is disconnected from Wi-Fi during [Time Lapse Shot] recording.
- When [Auto Transfer] in [Bluetooth] is set to [ON], [Wi-Fi Function] is not available.

❖ Images That Can be Sent

Images that can be sent differ depending on the destination device.

Destination device	Images that can be sent	
	[Send Images While Recording]	[Send Images Stored in the Camera]
[Smartphone] (→404)	JPEG/RAW	JPEG/RAW/MP4*1
[PC] (→407)	JPEG/RAW	JPEG/RAW/MP4/ 4K burst files/ Post-Focus images
[Cloud Sync. Service] (→416)	JPEG	JPEG/MP4
[Web service] (→414)	JPEG/RAW*2	JPEG/MP4/RAW*2
[AV device] (→412)	JPEG	JPEG
[Printer] (→410)	—	JPEG

*1 Files larger than 4 GB cannot be sent.

*2 Sending is possible when the destination web service supports the sending of RAW images from this camera.

- You will need an Android with an operating system of 7.0 or higher to send/save RAW images to an Android device. The pictures, however, may not be displayed correctly on some smartphones or some versions of operating systems.
- 4K videos cannot be sent to [Cloud Sync. Service], and [Web service].



- Sending may not be possible depending on your device.
- It may not be possible to send images recorded with devices other than this camera, or images edited or processed on a PC.

❖ Fn Button Assigned with [Wi-Fi]

You can perform the following operations by pressing the Fn button assigned with [Wi-Fi] after connecting to Wi-Fi.

For information on Fn buttons, refer to page [292](#).

[Terminate the Connection]	Terminates the Wi-Fi connection.
[Change the Destination]	Terminates the Wi-Fi connection, and allows you to select a different Wi-Fi connection.
[Change Settings for Sending Images]	Sets the image size, file format, and other items for sending recorded images. (→ 424)
[Register the Current Destination to Favorite]	Registers the current connection destination or method so that you can easily connect with the same connection settings next time.
[Network Address]	Displays the MAC address and IP address of the camera. (→ 428)

- Depending on the Wi-Fi function being used or the connection destination, you may not be able to perform some of these operations.

[Smartphone]

Transfer recorded images to a smartphone connected using Wi-Fi.

Getting started:

- Install “LUMIX Sync” on your smartphone. (→374)

1 Select the method for sending the images on the camera.

- **MENU/SET** ⇒ [**Wi-Fi**] ⇒ [Wi-Fi] ⇒ [Wi-Fi Function] ⇒ [New Connection] ⇒ [Send Images While Recording]/[Send Images Stored in the Camera]

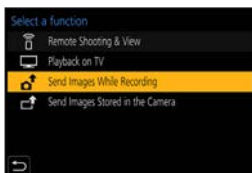

2 Set the destination to [Smartphone].



3 Connect the camera to a smartphone by Wi-Fi.

- Select [Via Network] (→418) or [Direct] (→421), and then connect.

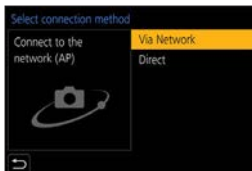

4 On the smartphone, start up “LUMIX Sync”.

5 Select the destination smartphone on the camera.

6 Check the send settings and then press .

- To change the send settings of images, press [DISP.]. (→424)

7 When [Send Images While Recording] is selected:

Take pictures.

- [] is displayed in the recording screen of the camera while a file is being sent.
- To end the connection, follow the steps below:

 ⇒ [] ⇒ [Wi-Fi] ⇒ [Wi-Fi Function] ⇒ [Yes]

When [Send Images Stored in the Camera] is selected:

Select an image.

- To end the connection, select [Exit].

❖ Sending Images on the Camera to a Smartphone with Simple Operations

You can transfer pictures to a smartphone connected by Bluetooth just by pressing [] ([Send Image (Smartphone)]) button during playback.

You can also use the menu to connect easily.



- Use the Fn button registered with [Send Image (Smartphone)] to operate. In default settings, this is registered in [Fn4].

For information about the Fn button, refer to page [292](#).





Getting started:

- Install “LUMIX Sync” on your smartphone. ([→374](#))
- Connect the camera to a smartphone by Bluetooth. ([→375](#))
- Press [] on the camera to display the playback screen.

Send a single image

- 1 Press   to select the image.
- 2 Press [].
- 3 Select [Single Select].
 - To change the send settings of images, press [DISP.]. ([→424](#))
- 4 On the smartphone, select [Yes] (for Android devices) or [Join] (for iOS devices).
 - This connects automatically using Wi-Fi.

Send multiple images

- 1 Press [].
- 2 Select [Multi Select].
 - To change the send settings of images, press [DISP.]. ([→424](#))
- 3 Select the images and then transfer.
 -  : Select images
 - : Set/Cancel
 - [DISP.]: Transfer
- 4 On the smartphone, select [Yes] (for Android devices) or [Join] (for iOS devices).
 - This connects automatically using Wi-Fi.

Using the menu to transfer easily

 → [] → [Bluetooth] → [Send Image (Smartphone)]

Settings: [Single Select]/[Multi Select]

- If [Single Select], press ◀▶ to select the image and then press  to execute.
- If [Multi Select], use the same operation as with “Send multiple images”.



- This function is not available when [Auto Transfer] in [Bluetooth] is set to [ON].

[PC]

Send recorded images to the PC connected with Wi-Fi.



Supported OS

Windows: Windows 10/Windows 8.1/Windows 8

Mac: OS X v10.5 to v10.11, macOS 10.12 to macOS 10.15

Getting started:

- If the workgroup of the destination PC has been changed from the standard setting, change the corresponding setting of the camera in [PC Connection]. (→427)

❖ Create a Destination Folder for Images

When using Windows (Example for Windows 10)

- 1 Select the destination folder and then right-click.
- 2 Select [Properties] and then enable folder sharing.

- You can also use “PHOTOfunSTUDIO” to create folders.
For details, refer to the operating instructions for “PHOTOfunSTUDIO”.

When using Mac (Example for OS X v10.14)

- 1 Select the destination folder and then click the items in the following order.

[File] ➔ [Get Info]

- 2 Enable folder sharing.



- Create a PC account name (up to 254 characters) and password (up to 32 characters) consisting of alphanumeric characters. A destination folder may not be created if the account name includes non-alphanumeric characters.
- When the computer name (NetBIOS name for Mac) contains a space (blank character), etc., it may not be recognized. In that case, we recommend changing the name to one consisting only of 15 or less alphanumeric characters.
- Refer to the operating instructions for your PC or Help on the OS for detailed setting procedures.

1 Select the method for sending images on the camera.

- **MENU/SET** ➔ [**WIFI**] ➔ [Wi-Fi] ➔ [Wi-Fi Function] ➔ [New Connection] ➔ [Send Images While Recording]/[Send Images Stored in the Camera]

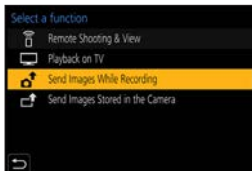

2 Set the destination to [PC].



3 Connect the camera and PC by Wi-Fi.

- Select [Via Network] (→418) or [Direct] (→421), and then connect.

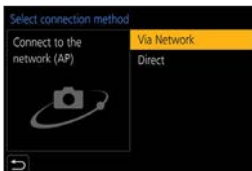

4 Enter the computer name of the PC name you want to connect to (for Mac, the NetBIOS name).



5 Select a folder for storing images.

- Folders sorted by sent date will be created in the selected folder, and images will be saved there.



6 Check the send settings and then press .

- To change the send setting, press [DISP.]. (→424)

7 When [Send Images While Recording] is selected: Take pictures.

- [📷] is displayed in the recording screen of the camera while a file is being sent.
- To end the connection, follow the steps below:

 ⇒ [🔧] ⇒ [Wi-Fi] ⇒ [Wi-Fi Function] ⇒ [Yes]

When [Send Images Stored in the Camera] is selected:

Select an image.

- To end the connection, select [Exit].



- If the screen for a user account and password entry appears, enter the one you set on your PC.
- When the firewall of the OS, security software, etc. is enabled, connecting to the PC may not be possible.

[Printer]

You can send images to a PictBridge (wireless LAN)*1-supported printer connected by Wi-Fi for printing.

*1 DPS over IP standard-compliant

1 Select the method for sending images on the camera.

-  ⇒ [🔧] ⇒ [Wi-Fi] ⇒ [Wi-Fi Function] ⇒ [New Connection] ⇒ [Send Images Stored in the Camera]



2 Set the destination to [Printer].



3 Connect the camera to a printer by Wi-Fi.

- Select [Via Network] (→418) or [Direct] (→421), and then connect.

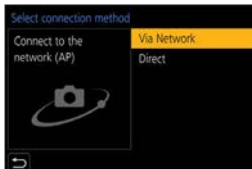

4 Select the destination printer.

5 Select and print images.

- The procedure for selecting images is the same as the one for when the USB connection cable is connected. (→444)
- To terminate the connection, press [↵].



- For details about PictBridge (wireless LAN-compatible) printers, contact their manufacturers.
- When [Auto Transfer] in [Bluetooth] is set to [ON], [Wi-Fi Function] is not available.

[AV device]

Still pictures and video can be sent to AV devices in the home (home AV devices), such as DLNA compatible recorders.

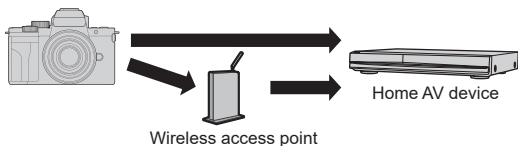

1 Select the method for sending images on the camera.

- **MENU/SET** ⇒ [**W**] ⇒ [Wi-Fi] ⇒ [Wi-Fi Function] ⇒ [New Connection] ⇒ [Send Images While Recording]/[Send Images Stored in the Camera]

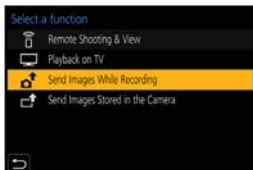

2 Set the destination to [AV device].



3 Connect the camera and PC by Wi-Fi.

- Select [Via Network] (→418) or [Direct] (→421), and then connect.

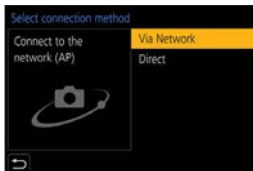

4 Select the device you wish to connect to.

5 Check the send settings, and select [Set].

- To change the send setting, press the [DISP.]. (→424)

6 When [Send Images While Recording] is selected:

Take pictures.

- [📷] is displayed in the recording screen of the camera while a file is being sent.
- To end the connection, follow the steps below:

 ⇒ [🔧] ⇒ [Wi-Fi] ⇒ [Wi-Fi Function] ⇒ [Yes]

When [Send Images Stored in the Camera] is selected:

Select an image.

- To end the connection, select [Exit].



- Sending may fail depending on the operational status of the AV device. Also, sending may take a while.
- When [Auto Transfer] in the [Bluetooth] is set to [ON], [Wi-Fi Function] is disabled.



[Web service]

You can use “LUMIX CLUB” to upload recorded images to web services such as social networking sites.

Getting started:

- Register with “LUMIX CLUB”. (→428)
- Before sending images to a service, register that web service. (→430)

1 Select the method for sending images on the camera.

-  ⇒ [] ⇒ [Wi-Fi] ⇒ [Wi-Fi Function] ⇒ [New Connection] ⇒ [Send Images While Recording]/[Send Images Stored in the Camera]

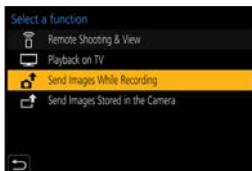

2 Set the destination to [Web service].



3 Connect to the web service.

- Select [Via Network] and then connect. (→418)

4 Select the web service.

5 Check the send settings and then press .

- To change the send settings of images, press [DISP.]. (→424)

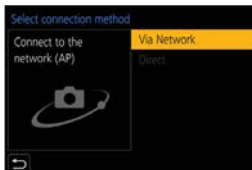

6 When [Send Images While Recording] is selected: Take pictures.

- [] is displayed in the recording screen of the camera while a file is being sent.
- To end the connection, follow the steps below:

 ⇒ [] ⇒ [Wi-Fi] ⇒ [Wi-Fi Function] ⇒ [Yes]

When [Send Images Stored in the Camera] is selected:

Select an image.

- To end the connection, select [Exit].



- If image sending fails, a report email outlining the failure will be sent to the email address registered in the "LUMIX CLUB".
- Panasonic assumes no responsibility for any damages resulting from the leakage, loss, etc. of images uploaded on web services.
- When uploading images to a web service, do not delete images from the camera, even after they have finished sending, until you have checked that they have been properly uploaded to the web service.
Panasonic assumes no responsibility for any damages resulting from the deletion of images stored on the camera.
- Images may contain information that can be used to identify the user, such as recording dates and times, and location information. Check carefully when uploading the images to a web service.



[Cloud Sync. Service]

This camera can automatically transfer recorded images to a cloud sync service via “LUMIX CLUB” to send them to a PC or smartphone.

To use [Cloud Sync. Service] (As of June 2020)

- You need to register to the “LUMIX CLUB” (→428) and set up cloud synchronization to send images to a cloud folder.
To set up cloud synchronization, use “PHOTOfunSTUDIO”.
- Sent images are temporarily saved in the cloud folder. These can be synchronized with your PC, smartphone, and other devices.
- A cloud folder stores sent images for 30 days (up to 1000 images). Please note that the images will be deleted automatically in the following cases:
 - If 30 days have passed after sending (even if within 30 days of the transfer, if images have been downloaded to all specified devices, then these may be deleted)
 - If there are in excess of 1000 images (depending on the [Cloud Limit] (→425) setting)

1 Select the method for sending images on the camera.

-  ⇒ [] ⇒ [Wi-Fi] ⇒ [Wi-Fi Function] ⇒ [New Connection] ⇒ [Send Images While Recording]/[Send Images Stored in the Camera]

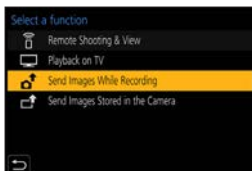

2 Set the destination to [Cloud Sync. Service].



3 Connect to the cloud sync service.

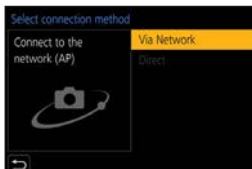

- Select [Via Network] and then connect. (→418)



4 Check the send settings and then press .

- To change the send settings of images, press [DISP.]. (→424)

5 When [Send Images While Recording] is selected: Take pictures.

- [] is displayed in the recording screen of the camera while a file is being sent.
- To end the connection, follow the steps below:
 ⇒ [] ⇒ [Wi-Fi] ⇒ [Wi-Fi Function] ⇒ [Yes]

When [Send Images Stored in the Camera] is selected: Select one or more images.

- To end the connection, select [Exit].

Wi-Fi Connections

When [New Connection] has been selected in [Wi-Fi Function] in [Wi-Fi] of the [Setup] menu, select the connection method from either [Via Network] or [Direct] to connect.

On the other hand, when you use [Select a destination from History] or [Select a destination from Favorite], the camera connects to the selected device with the previously-used settings.

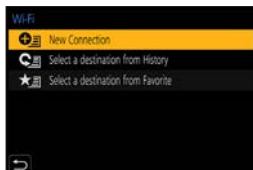

[Via Network]

Connect the camera and destination device through the wireless access point.

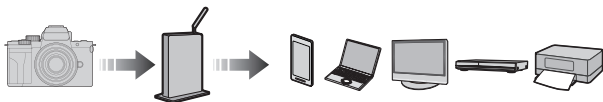

Select the method for connecting to a wireless access point.

Settings:[WPS (Push-Button)]/[WPS (PIN code)]/[From List] (→419)

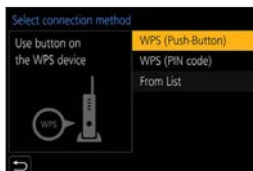

- After selecting [Via Network] once, the camera will connect to the previously-used wireless access point. To change the wireless access point used for connection, press [DISP.] and change the connection destination.
- Check the operating instructions and settings of the wireless access point.

❖ [WPS (Push-Button)]

Press the WPS button on the wireless access point to set up a connection.

Example)

Press the wireless access point WPS button until it switches to WPS mode.

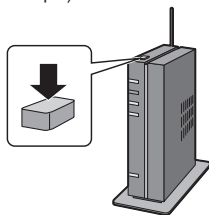

❖ [WPS (PIN code)]

Enter a PIN code into the wireless access point to set up a connection.

- 1 On the camera screen, select the wireless access point you are connecting to.
- 2 Enter the PIN code displayed on the camera screen into the wireless access point.
- 3 Press  of the camera.

❖ [From List]

Searches for a wireless access point to use, and connects to this.



- Confirm the encryption key of the wireless access point.

- 1 Select the wireless access point you are connecting to.
 - Press [DISP.] to run a wireless access point search again.
 - If no wireless access point is found, refer to “Connecting by Manual Input” on page 420.

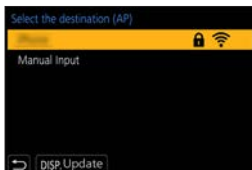

- 2 (If network authentication is encrypted)
Enter the encryption key.

❖ Connecting by Manual Input



- Check the SSID, network authentication, encryption, and encryption key of the wireless access point you are using.

- 1 In the screen in Step 1 of “[From List]”, select [Manual Input]. (→420)
- 2 Enter the SSID of the wireless access point you are connecting to, and then select [Set].
- 3 Select the network authentication.

[WPA2-PSK]	Supported encryption: [TKIP], [AES]
[WPA2/WPA-PSK]	
[No Encryption]	—

- 4 (When other than [No Encryption] is selected)
Enter the encryption key and then select [Set].

[Direct]

Directly connect the camera and the destination device.

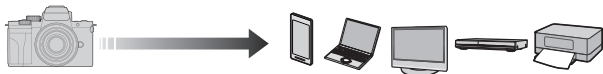

Select the method for connecting with the destination device.

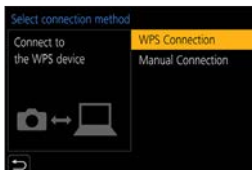

[WPS Connection]	[WPS (Push-Button)]	Press the WPS button on the destination device to connect. <ul style="list-style-type: none"> On the camera, press [DISP.] to extend the connection wait time.
	[WPS (PIN code)]	Enter the PIN code into the camera, and connect.
[Manual Connection]	Search for the camera on the destination device to connect. Enter the SSID and password displayed on the camera into the device. <ul style="list-style-type: none"> If the destination is set to [Smartphone], the password is not displayed. Select the SSID to establish a connection. (→380) 	



- Please also refer to the operating instructions for the device to be connected.

Connect to Wi-Fi Using Previously Saved Settings

Use the Wi-Fi connection history to connect using the same settings as previously.

1 Display the Wi-Fi connection history.

- Press **MENU/SET** ⇒ **[Wi-Fi]** ⇒ **[Wi-Fi Function]** ⇒ **[Select a destination from History]**/ **[Select a destination from Favorite]**

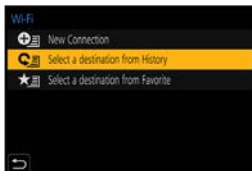

2 Select the History item to connect to.

- Press **[DISP.]** to confirm details of the connection history.

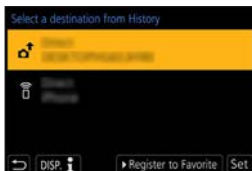



❖ Register to Favorite

You can register the Wi-Fi connection history to Favorite.

- 1 Display the Wi-Fi connection history.
 - Press **MENU/SET** ⇒ **[Wi-Fi]** ⇒ **[Wi-Fi Function]** ⇒ **[Select a destination from History]**
- 2 Select the History item to register and then press **▶**.
- 3 Enter a registration name and then select **[Set]**.
 - A maximum of 30 characters can be entered. A two-byte character is treated as two characters.

❖ Editing Items Registered in Favorite

- 1 Display items registered to Favorite.
 -  ⇒ [] ⇒ [Wi-Fi] ⇒ [Wi-Fi Function] ⇒ [Select a destination from Favorite]
- 2 Select the History item to edit in Favorite and then press ►.

[Remove from Favorite]	—
[Change the Order in Favorite]	Specify the destination location of the desired item to change the display order.
[Change the Registered Name]	Enter characters to change the registered name.



- The number of items that can be saved in History is limited. Register frequently-used connection settings to Favorite.
- When [Reset] in the [Setup] menu is used to reset the network settings, the content registered in History and Favorite is deleted.
- If the device you want to connect to (smartphone, etc.) is connected to a wireless access point other than the camera, you cannot connect the device to the camera using [Direct].
Change the Wi-Fi settings of the device you want to connect to so that the access point to be used is set to the camera. You can also select [New Connection] and reconnect the devices. (→380)
- It may be difficult to connect to networks to which many devices are connected. In these cases, connect using [New Connection].

Send Settings and Selecting Images

Image Send Settings

Set the size, file format, and other items for sending the image to the destination device.

- 1** After Wi-Fi connection, the send settings confirmation screen will be displayed, so press [DISP.].
- 2** Change the send settings.

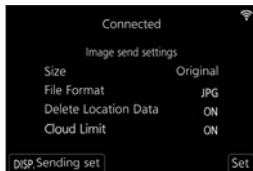

[Size]	Resize the image to send. [Original]/[Auto]/[Change] ([M], [S], or [VGA]) <ul style="list-style-type: none">• The [Auto] image size changes depending on the status of the destination device. (This can be set when the destination is [Web service])
[File Format]	Sets the file format of images to send. [JPG]/[RAW+JPG]/[RAW] <ul style="list-style-type: none">• This setting is possible when the destination supports the sending of RAW images from this camera. (→402)
[Delete Location Data]	Select whether to delete the location information from images before sending them. <ul style="list-style-type: none">• This can be set when the destination is [Cloud Sync. Service] or [Web service].• This operation only deletes the location information from the images that are set to be sent.
[Cloud Limit]	You can select whether to send images when the cloud folder runs out of free space. [ON]: Does not send images. [OFF]: Deletes images from the oldest ones, then sends new images. <ul style="list-style-type: none">• This can be set when the destination is [Cloud Sync. Service].

Selecting Images

When sending by [Send Images Stored in the Camera], select the images using the following procedure.

1 Select [Single Select] or [Multi Select].



2 Select the image.

[Single Select] setting

- 1 Press ◀▶ to select an image.
- 2 Press .



[Multi Select] setting

- 1 Press ▲▼◀▶ to select an image and then press . (Repeat this)
 - To cancel the setting, press  again.
- 2 Press [DISP.] to execute.

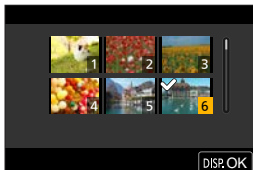

[Wi-Fi Setup] Menu

This configures the settings required for the Wi-Fi function.
The settings cannot be changed when connected to Wi-Fi.

Displaying the [Wi-Fi Setup] menu.

-  ⇒  ⇒ [Wi-Fi] ⇒ [Wi-Fi Setup]

[Priority of Remote Device]	This sets either the camera or the smartphone as the priority control device to be used during remote recording. (→388)
[Wi-Fi Password]	You can use a password to connect for enhanced security. (→382)
[LUMIX CLUB]	This acquires or changes the “LUMIX CLUB” login ID. (→429)
[PC Connection]	<p>You can set the workgroup. To send images to a PC, you need to connect to the same workgroup as the destination PC. (The default setting is “WORKGROUP”.)</p> <ul style="list-style-type: none"> • To change the workgroup name, press  and enter the new workgroup name. • To return to the default settings, press [DISP.].
[Device Name]	<p>You can change the name (SSID) of the camera.</p> <ul style="list-style-type: none"> • To change the SSID name, press [DISP.] and enter the new SSID name. • A maximum of 32 characters can be entered.

[Wi-Fi Function Lock]	To prevent incorrect operation and use of the Wi-Fi function by a third party and to protect personal information in the camera and included with images, protect the Wi-Fi function with a password. [Setup]: Enter any 4-digit numbers as the password. [Cancel]: Cancel the password. <ul style="list-style-type: none">• Once a password is set, you are required to enter it each time you use the Wi-Fi function.• If you forget your password, you can use [Reset Network Settings] in the [Setup] menu to reset the network settings and thereby reset the password.
[Network Address]	Displays the MAC address and IP address of the camera.

“LUMIX CLUB”

Refer to the “LUMIX CLUB” site for details.

<https://lumixclub.panasonic.net/eng/c/>



- The service may be suspended due to regular maintenance or unexpected troubles, and the service contents may be changed or added, without prior notice to the users.

The service may also be stopped in whole or in part with a reasonable period of advance notice.

❖ Acquire a New Login ID from the Camera

From the camera menu, acquire a “LUMIX CLUB” login ID.

1 Follow the menu path.

- **MENU/SET** ⇒ [**Wi-Fi**] ⇒ [Wi-Fi Setup] ⇒ [LUMIX CLUB] ⇒ [Set/Add Account] ⇒ [New account]
- Connect to the network.
Proceed to the next page by selecting [Next].



2 Select and set the method for connecting to a wireless access point, and set. (→ 418)

- Except for the first-time connection, the camera will connect to the previously-used wireless access point.
To change the connection destination, press [DISP].
- Proceed to the next page by selecting [Next].

3 Read through the “LUMIX CLUB” terms of use and then select [Agree].

- Switch pages: ▲▼
- Zoom: Rotate to the right (to restore: rotate to the left)
- Move the enlarged area: ▲▼◀▶
- Cancel without registering: [**Back**]

4 Enter a password.

- Enter any combination of 8 to 16 characters and numbers for the password.

5 Check the login ID and then select [OK].

- Be sure to make a note of the login ID and password.
- The login ID (12-digit number) will be displayed automatically.

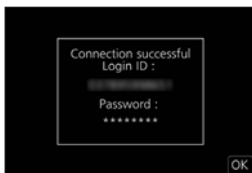

❖ Register a Web Service with “LUMIX CLUB”



- Confirm web services supported by “LUMIX CLUB” in “FAQ/Contact us” at the following site:

https://lumixclub.panasonic.net/eng/c/lumix_faqs/

Getting started:

- Make sure that you have created an account on the web service you want to use, and have the login information available.
- 1 Connect to the “LUMIX CLUB” site using a smartphone or PC.
<https://lumixclub.panasonic.net/eng/c/>
 - 2 Enter your “LUMIX CLUB” login ID and password to log in.
 - If you have not registered your email address to the “LUMIX CLUB” yet, please register it.
 - 3 Select and register the web service you want to use for web service link settings.
 - Follow the on-screen instructions to perform the registration.

❖ Confirm/Change Login ID or Password

Getting started:

- When using the acquired login ID, check the ID and password.
- Access the “LUMIX CLUB” site from your PC to change the password.

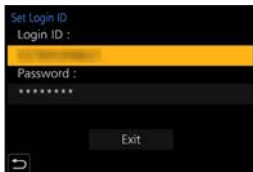

- 1 Follow the menu path.
 - **MENU/SET** ⇒ **[Wi-Fi]** ⇒ **[Wi-Fi Setup]** ⇒ **[LUMIX CLUB]** ⇒ **[Set/Add Account]** ⇒ **[Set Login ID]**
 - The login ID and password are displayed.
 - The password is displayed as “*”.



- 2 Select the item to change.
- 3 Enter the login ID or password.
- 4 Select [Exit].

❖ Checking the “LUMIX CLUB” Terms of Use

Check the details if the terms of use have been updated, for example.

 ⇒ [] ⇒ [Wi-Fi] ⇒ [Wi-Fi Setup] ⇒ [LUMIX CLUB] ⇒ Select [Terms of use]

❖ Deleting Your Login ID and Closing Your “LUMIX CLUB” Account

Delete the login ID from the camera when transferring it to another party or disposing of it.

You can also close your “LUMIX CLUB” account.



- You can only change or delete the login ID acquired with the camera.

1 Follow the menu path.

-  ⇒ [] ⇒ [Wi-Fi] ⇒ [Wi-Fi Setup] ⇒ [LUMIX CLUB] ⇒ [Delete account]
- A message is displayed. Select [Next].

2 Select [Yes] on the login ID delete confirmation screen.

- A message is displayed. Select [Next].

3 Select [Yes] on the confirmation screen asking whether to close the “LUMIX CLUB” account.

- A message is displayed. Select [Next].
- To continue without closing the account, select [No] to delete only the login ID.

4 Select [OK].

15. Connecting to Other Devices

This chapter describes connections with other devices, such as TVs and PCs.

[HDMI] socket

Connect the camera and TV with a commercially available HDMI micro cable.

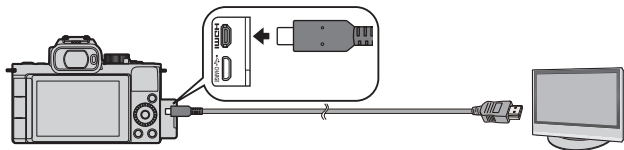

- Use a "High Speed HDMI micro cable" with the HDMI logo.
Cables that do not comply with the HDMI standards will not work.
"High Speed HDMI micro cable" (Type D - Type A plug, up to 2 m (6.6 feet) long)

[USB/CHARGE] socket

Use a USB connection cable to connect the camera to a PC, recorder, or printer.

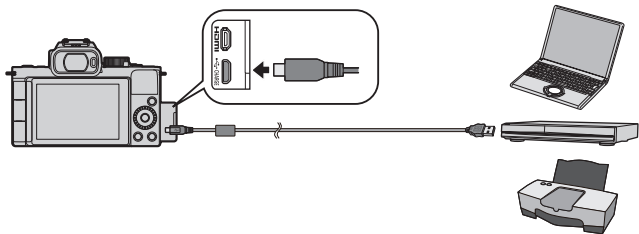

- Do not use any other USB connection cables except the supplied one.



- Check the direction of the terminals and plug in/out straight holding onto the plug. (Inserting these at an angle may cause deformation or malfunction)
- Do not connect the cable to the wrong terminals. This may cause a malfunction.

Viewing on a TV

You can connect the camera to a TV to view recorded pictures and videos on the TV.

Getting started:

- Turn off the camera and TV.

1 Connect the camera and TV with a commercially available HDMI micro cable. (→432)

2 Turn on the TV.

3 Switch the TV input to HDMI input.

4 Turn on the camera.

5 Display the playback screen.

- Press [▶].
- The recorded images are displayed on the TV. (The monitor and viewfinder of the camera will turn off.)

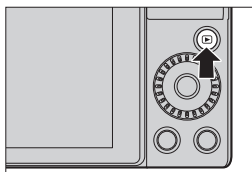



- With the default settings, pictures are output at the optimal resolution for the connected TV.
The output resolution can be changed in [HDMI Mode (Play)]. (→357)
- To play back 24p videos, set [HDMI Mode (Play)] to [AUTO]. Otherwise, the picture is not output at 24 frames per second.
- Depending on the aspect ratio, gray bands may be displayed on the top and bottom or the left and right of images.
- Wi-Fi connection is not available while using the HDMI output.
- Some of setting screens are not output through the HDMI connection.
- HDMI output will be canceled if a USB connection cable is connected simultaneously.
- Change the screen mode on your TV if images are displayed with the top or bottom cut off.
- Please also refer to the operating instructions for the TV.



❖ Using VIERA Link

VIERA Link (HDAVI Control™) is a function that allows you to use your remote control for the Panasonic TV for easy operations when the camera has been connected to a VIERA Link compatible device using an HDMI micro cable for automatic linked operations.

(Not all operations are possible.)



- To use VIERA Link, you need to also configure the settings on the TV.
For the setting procedure, refer to the operating instructions for the TV.

- 1 Connect the camera to a Panasonic TV compatible with VIERA Link using a commercially available HDMI micro cable. (→432)
- 2 Turn on the camera.
- 3 Turn on the VIERA Link.
 -  ⇒  ⇒ [TV Connection] ⇒ [VIERA Link] ⇒ [ON]
- 4 Display the playback screen.
 - Press [].
- 5 Operate with the remote control for the TV.

Power off link

If you turn off the TV with its remote control, the camera will also turn off.

Automatic input switching

If you turn on the camera and then press [], the input of the TV automatically switches to input to which this camera is connected.

Furthermore, when the TV power is in the standby state, it turns on automatically. (When “Power on link” on the TV is set to “Set”)



- VIERA Link is a unique Panasonic function built on an HDMI control function using the standard HDMI CEC (Consumer Electronics Control) specification. Linked operations with HDMI CEC compatible devices made by other companies are not guaranteed.
- The camera supports “VIERA Link Ver.5”. “VIERA Link Ver.5” is the standard for Panasonic's VIERA Link compatible devices. This standard is compatible with Panasonic's conventional VIERA Link devices.
- Operation using the buttons on the camera will be limited.

Recording while monitoring camera images

When using the HDMI output, you can take pictures while monitoring the camera image on a TV, etc.



- The monitor and viewfinder of the camera will turn off.
- When using the AF mode [] or MF assist, the screen cannot be enlarged in windowed mode.
- The aspect ratio setting is fixed to [16:9].
- An electronic sound or shutter sound will not sound.
- Wi-Fi connection is not available while using the HDMI output.
- Some of setting screens are not output through the HDMI connection.
- When the following functions are being used, HDMI output is not available:
 - Video recording, [4K PHOTO], [Post Focus]



- You can change the recording information to be outputted via HDMI, from constant display to display only during operations or not to be displayed:
 - [] ⇒ [TV Connection] ⇒ [HDMI Info Display (Rec)] (→ [358](#))

Importing Images to a PC

If you connect the camera to a PC, you can copy the recorded images to the PC.

- When using Windows, you can also copy using the “PHOTOfunSTUDIO” software for LUMIX. (→441)
- When using Mac, you can copy using “iMovie”.
For details about iMovie, please contact Apple Inc.

Copying Images to a PC



- The camera can be connected to a PC running any of the following OSs which can detect mass storage devices.

Supported OS

Windows: Windows 10/Windows 8.1/Windows 8

Mac: OS X v10.5 to v10.11, macOS 10.12 to macOS 10.15

Getting started:

- Turn on the camera and PC.

- 1 Connect the camera and PC with the USB connection cable. (→433)**
- 2 Press ▲ ▼ to select [PC(Storage)] and then press .**
 - Windows: A drive (“LUMIX”) is displayed in [This PC].
 - Mac: A drive (“LUMIX”) is displayed on the desktop.
- 3 Drag the files and folders from the camera to the PC.**

❖ Folder Structure Inside Card

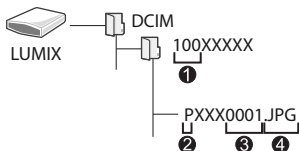

DCIM:

① Folder number

② Color space

③ File number

④ JPG:

RW2:

MP4:

Images

P: sRGB

_: AdobeRGB

JPEG format pictures

RAW format pictures

MP4 videos,

4K burst files

❖ Copying Images to a PC Using “PHOTOfunSTUDIO”

Getting started:

- Turn on the camera and PC.
- Install “PHOTOfunSTUDIO” on PC. (→440)

① Connect the camera and PC with the USB connection cable. (→433)

② Press ▲ ▼ to select [PC(Storage)] and then press .

③ Copy images to the PC using “PHOTOfunSTUDIO”.

- Do not delete or move the copied files and folders in, for example, Windows Explorer.
Playback and editing using “PHOTOfunSTUDIO” will become no longer possible.



- If [USB Mode] is set to [PC(Storage)] in the [Setup] menu, the camera will be automatically connected to the PC without the [USB Mode] selection screen being displayed. (→357)



- Take care not to turn off the camera while images are being imported.
- After importing of the images is completed, perform the operation to safely remove the USB connection cable on the PC.
- Turn off the camera and disconnect the USB connection cable before removing the card from the camera. Otherwise, the recorded data may be damaged.

Installing Software

Install the software to perform operations such as organizing and correcting recorded images, processing RAW images, and editing videos.



- To download the software, your PC needs to be able to connect to the internet.
- Supported OS versions as of June 2020. Supported OS versions may be changed without prior notice.

❖ PHOTOfunSTUDIO 10.0 AE

This software allows you to manage your images. For example, it allows you to import pictures and videos to your PC and then sort them by recording date, model name.

You can also perform operations such as writing images to a DVD, correcting images, and editing videos.

Check the following site and then download and install the software:

https://panasonic.jp/support/global/cs/soft/download/d_pfs10ae.html

(English only)

Download expiration: July 2025

Operating environment

Supported OS	Windows 10 (32-bit/64-bit) Windows 8.1 (32-bit/64-bit) • For 4K videos and 4K photos, a 64-bit version of the Windows 10/Windows 8.1 OS is required.
CPU	Pentium® 4 (2.8 GHz or higher)
Display	1024×768 or higher (1920×1080 or higher is recommended)
Installed memory	1 GB or more for 32-bit, 2 GB or more for 64-bit
Free hard disk space	450 MB or more for installing the software

- A high-performance PC environment is required to use the playback and editing functions for 4K videos or the picture cropping function for 4K photos. For details, refer to the operating instructions for "PHOTOfunSTUDIO".
- "PHOTOfunSTUDIO" is not available for Mac.

❖ SILKYPIX Developer Studio SE

This software processes and edits RAW images.

Edited images can be saved in a format (JPEG, TIFF, etc.) that can be displayed on a PC.

Check the following site and then download and install the software:

<http://www.isl.co.jp/SILKYPIX/english/p/>

Operating environment

Supported OS	Windows	Windows 10 (64-bit recommended) Windows 8.1 (64-bit recommended)
	Mac	OS X v10.10 to v10.11 macOS 10.12 to macOS 10.15

- For more information such as how to use “SILKYPIX Developer Studio”, refer to the Help or the Ichikawa Soft Laboratory’s support site.

❖ 30-Day Full Trial Version of “LoiLoScope” (Free)

This software allows you to easily edit videos.

Check the following site and then download and install the software:

<http://loilo.tv/product/20>

Operating environment

Supported OS	Windows	Windows 10 Windows 8.1 Windows 8
--------------	---------	--

- For more information on how to use “LoiLoScope”, refer to the “LoiLoScope” manual available for download at the site.
- “LoiLoScope” is not available for Mac.

Storing on a Recorder

By connecting the camera to a Panasonic Blu-ray disc recorder or DVD recorder, you can store the pictures and videos.

Getting started:

- Turn on the camera and recorder.

- 1 Connect the camera and recorder with the USB connection cable. (→433)**
- 2 Press ▲ ▼ to select [PC(Storage)] and then press .**
- 3 Operate the recorder to store the images.**



- If [USB Mode] is set to [PC(Storage)] in the [Setup] menu, the camera will be automatically connected to the recorder without the [USB Mode] selection screen being displayed. (→357)



- Take care not to turn off the camera while storage is in progress.
- Images such as 4K videos may not be supported depending on your recorder.
- Turn off the camera and disconnect the USB connection cable before removing the card from the camera. Otherwise, the recorded data may be damaged.
- For the storage and playback procedures, refer to the operating instructions for the recorder.

Printing

If you connect the camera to a printer that supports PictBridge, you can select pictures on the camera's monitor and then print them.

Getting started:

- Turn on the camera and printer.
- Set the print quality and other settings on the printer.

1 Display the playback screen.

- Press [▶].

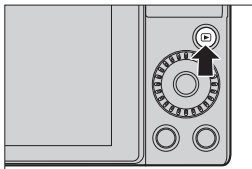

2 Connect the camera and printer with the USB connection cable. (→433)

3 Press ▲▼ to select [PictBridge(PTP)] and then press [MENU/SET].

4 Press ◀▶ to select a picture and then press [MENU/SET].

- To print multiple pictures, press ▲, set the picture selection method, and then select pictures.



[Multi Select]	Selects the picture to print. 1 Press ▲▼◀▶ to select a picture and then press [MENU/SET]. • To cancel the setting, press [MENU/SET] again. 2 Press [DISP.] to end selection.
[Select All]	Prints all the stored pictures.
[Rating]	Prints all pictures with [Rating] levels from [★1] to [★5].

5 Set the print settings.

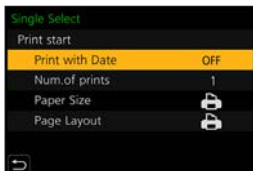

[Print with Date]	Sets printing with date. • If the printer does not support printing with date, the date cannot be printed.
[Num. of prints]	Sets the number of prints to be printed (up to 999).
[Paper Size]	Sets the paper size.
[Page Layout]	Sets whether to add borders and how many images to be printed on each sheet of paper.

6 Start printing.



- Select [Print start] and then press





- If [USB Mode] is set to [PictBridge(PTP)] in the [Setup] menu, the camera will be automatically connected to the printer without the [USB Mode] selection screen being displayed. (→357)



- Take care not to turn off the camera while printing is in progress.
- Do not disconnect the USB connection cable while [] (Cable disconnect prohibit icon) is displayed.
- Disconnect the USB connection cable after printing.
- Turn off the camera and disconnect the USB connection cable before removing the card from the camera. Otherwise, the recorded data may be damaged.
- To print images with paper size and layout settings not supported by the camera, set the [Paper Size] and [Page Layout] to [] and then select the desired settings on the printer.
(For details, refer to the operating instructions for your printer.)
- If a yellow [] is displayed, the camera is receiving an error message from the printer. Check that there is no problem with the printer.
- If the number of prints is high, the pictures may be printed in batches. In this case, the remaining number of prints indicated may differ from the number set.
- You cannot print RAW images.
- Images recorded with the following functions cannot be printed:
 - Video recording, [4K Burst], [Post Focus]

16. Materials

Using Optional Accessories

- For information on the tripod grip, refer to page 70.

External Flash (optional)

After attaching the flash (DMW-FL580L, DMW-FL360L, DMW-FL200L: optional), the effective range will be increased when compared to the camera's built-in flash.

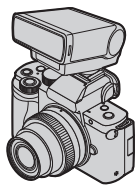

- 1 Close the built-in flash and set the Camera on/off switch to [OFF].**
- 2 Attach the external flash to the hot shoe and then turn on the camera and the external flash.**
 - Refer to (→236) for changing the settings for external flashes on the camera.
 - Refer to (→234) about the settings for the wireless flash.

❖ Removing the Hot Shoe Cover

Before attaching the Flash (optional), remove the hot shoe cover. Refer to the operating instructions for the Flash for details about how to attach it.

Remove the hot shoe cover by pulling it in the direction indicated by arrow ② while pressing it in the direction indicated by arrow ①.





- When an external flash is attached, do not carry the camera by holding only the external flash. It may become detached.
- When using a commercially available external flash, do not use one with reversed polarity or function for communicating with a camera. It may cause the camera to malfunction, or it may not operate correctly.
- If you take pictures close to the subject while taking wide-angle pictures, the light of the flash is obstructed by the lens and the bottom of the screen may be dark.
- Refer to the operating instructions of the external flash for further details.

External Microphones (Optional)

With a Stereo Shotgun Microphone (DMW-MS2: optional) or Stereo Microphone (VW-VMS10: optional), you can record higher-quality audio compared to the built-in microphone.

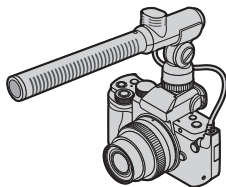

1 Close the built-in flash and set the Camera on/off switch to [OFF].

2 Connect the camera and external microphone.

- Remove the hot shoe cover. (→447)
- Insert the cord in the direction shown in the figure.
- If the cord has too much slack, you can secure it by tucking it into the cord holder.

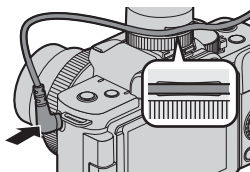



- While the external microphone is connected, [🔊] is displayed on the screen. Make sure that the external microphone is connected properly before you start recording.



- Do not use the stereo microphone cables with the length of 3 m (9.8 feet) or more.
- When an external microphone is connected, [Sound Rec Level Disp.] automatically turns [ON], and the recording level is displayed on the screen.
- When the external microphone is attached, do not carry the camera by holding the external microphone. It may become detached.
- When an external microphone is attached to the camera, do not open the built-in flash.
- If noises are recorded when using the AC adaptor, use the battery.
- For details, refer to the operating instructions for the external microphone.

❖ Setting the Sound Pickup Range (DMW-MS2: Optional)



When the Stereo Shotgun Microphone (DMW-MS2: optional) is connected, you can set the microphone sound pickup range.

① Select [Special Mic.].

- → → [Special Mic.]

[STEREO]	Picks up sound over a wide area.
[LENS AUTO]	Picks up sound from a range automatically set by the lens angle of view.
[SHOTGUN]	Helps prevent picking up background noise, and records sound from a specific direction.
[S.SHOTGUN]	Narrows the sound pickup range more than with [SHOTGUN].
[MANUAL]	Sets the range manually for sound pickup.

② (When [MANUAL] is selected)

Press ◀▶ to adjust the sound pickup range and then press .



- You can register the [MANUAL] sound pickup range setting in an Fn button:
 → → [Fn Button Set] → [Setting in REC mode] → [Special Mic. Directivity Adjust] (→ 293)

❖ Reduction of Wind Noise



This reduces wind noise when an external microphone is connected.

→ → Select [Wind Cut]

Settings: [HIGH]/[STANDARD]/[LOW]/[OFF]



- Setting [Wind Cut] may alter the usual sound quality.

AC Adaptor (Optional)/DC Coupler (Optional)

With an AC Adaptor (DMW-AC10: optional) and DC Coupler (DMW-DCC11: optional), you can perform recording and playback without worrying about the remaining battery charge.











- Be sure to purchase both an AC Adaptor and a DC Coupler as a set. They cannot be used independently of one another.
- When the DC Coupler is being mounted, the DC Coupler cover opens, so the structure ceases to be dust and splash resistant. Do not allow sand, dust and water droplets to adhere to or enter the camera. After use, confirm that no foreign objects are adhering to the DC Coupler cover, then firmly close the cover.
- For details, refer to the operating instructions for the AC Adaptor and DC Coupler.

LC	Live View Composite recording (→101)
	Multiple exposures (→325)
	[Digital Zoom] (→155)
	Electronic shutter (→202)
	Picture-taking during video recording (Photo Priority) (→242)
	Temperature rise warning icon (→463)
	Image stabilizer (→204)
	Camera shake alert (→206)
PRE	Pre-Burst recording (→165)
	Focus (turns green) (→50)/ Recording state (turns red) (→238)
	Focus (in low light AF situations) (→127)
	Focus (Starlight AF) (→127)
EXPS	Filter setting (→224)
	Filter effect adjustment (→111, 224)
	Card (displayed only during recording) (→39)
XXmXXs	Elapsed recording time (→238)
	Simultaneous recording indicator (→243)

②	Name*1 (→349)
	Travel elapsed days*2 (→353)
	Location*2 (→353)
	Age in years/months*1 (→349)
	Current date/time*2
	Travel destination setting*2:  (→352)
	Exposure meter (→345)
	Focal distance display (→156)
	Step zoom (→156)

③		Image being sent (→393)
		AF area (→129)
	+	Spot metering target (→207)
	+	Center marker (→344)
		Self-timer (→184)
		Histogram (→343)
		Audio recording level display (→263)
		Built-in microphone setting (→86, 265)
		External microphone (→448)
		Silent mode (→201)
		Metering mode (→207)
		AEL AE Lock (→210)
	60	Shutter speed (→50)
	F3.5	Aperture value (→50)
		Aperture Bracket (→198)

	Exposure compensation value (→208)
	Exposure Bracket (→198)
	Brightness (exposure) (→81, 115)
	Manual Exposure Assist (→99)
	ISO sensitivity (→212)
  	White balance (→215)
 	White Balance Bracket (→200)
AWB + AWB -	Adjusting the white balance (→219)
	Coloring (→81)

	Connected to Wi-Fi (→371)
	Connected to Bluetooth (→377)
GPS	Location logging (→395)
98	Number of pictures that can be taken (→487)
r20	Number of pictures that can be taken continuously (→160)
RXXmXXs	Available recording time (→487)
-----	No card

*1 This is displayed for about 5 seconds when the camera is turned on if the [Profile Setup] setting is set.

*2 This is displayed for about 5 seconds when the camera is turned on, after setting the clock and after switching from Playback Mode to Recording mode.

5

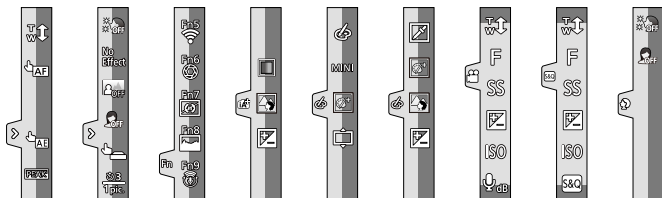

Touch Tab (→339)

	Touch Zoom (→153)
	Touch AF, Touch Shutter (→68)
	Touch AE (→69)
	Focus Peaking (→342)
	Self Shot Mode (→83)
	Fn button (→296)
	Coloring (→81)
	Defocus control function (→82, 115)
	Brightness (exposure) (→81, 115)
	Type of defocus ([Miniature Effect]) (→113)
	One Point Color (→114)

	Light source position ([Sunshine]) (→114)
	Filter effect adjustment (→116, 224)
	Filter on/off (→224)
	Filter setting (→224)
	Aperture value (→246, 252)
	Shutter speed (→246, 252)
	Exposure compensation (→246, 252)
	ISO sensitivity (→246, 252)
	Sound recording level adjustment (→246)
	[S&Q Effect] (→252)
	Scene Guide Mode [Clear Portrait] ([Soft Skin], [Slimming Mode]) (→107)

❖ Monitor recording information screen



①

	Recording mode (→52)
1/60	Shutter speed (→50)
F3.5	Aperture value (→50)
	Battery indication (→35)

②

	ISO sensitivity (→212)
	Exposure compensation value (→208)/ Manual Exposure Assist (→99)
	Flash setting (→231, 232, 234)/ Flash mode (→227)

③

	Drive mode (→157)
AFS	Focus mode (→124, 146)
	AF mode (→129)
	[Quality] (→119)
	Recording quality (→239)

	[Aspect Ratio] (→117)/ [Picture Size] (→118)
	[S&Q Effect] (→254)
	Wi-Fi/Bluetooth connection state (→371)
	Fn button settings (→292)

④

	Photo Style (→221)
AWB	White balance (→215)
	[i.Dynamic] (→317)
	Metering mode (→207)
98	Number of pictures that can be taken (→487)
r20	Number of pictures that can be taken continuously (→160)
RXXmXXs	Available recording time (→487)
---	No card

Playback Screen









①

	Playback mode (→361)
	Protected picture (→362)
GPS	Location logging (→395)
★3	Rating (→362)
	Cable disconnect prohibit icon (→446)
	Video playback (→272)
	Saving pictures from a 4K burst file (→168)
	Saving pictures from a Post-Focus image (→179)
	Text stamped display (→365)
XXmXXs	Elapsed playback time (→272)

②

	Icon indicating the presence of a marker (→170, 172)
	4K Photo (4K burst file) (→162)
	[Post Focus] (→176)
	[Focus Stacking] (→181)
4:3 L	[Aspect Ratio] (→117)/ [Picture Size] (→118)
MP4 FHD60P	Recording quality (→239)
SNAP	[Snap Movie] (→255)
	[Quality] (→119)
2x QUICK	[S&Q Effect] (→254)
	Battery indication (→35)
1/98	Image number/Total number of images
	Wi-Fi/Bluetooth connection state (→371)
15 pic.	Number of group images
XXmXXs	Video recording time (→272)
	S&Q playback time/ recording time (→254)

③

	Clear Retouch completed icon (→284)
	Obtaining information
	Playback (Video) (→272)
 1ST DAY	Travel elapsed days (→353)
	Group images (→278)
	Silent mode (→201)

④

Name*1 (→349, 351)
Location*1 (→353)
Title*1 (→363)
Age in years/months (→349, 351)

⑤

Recording information

*1 It is displayed in order of [Title], [Location], [Name] ([Baby1]/[Baby2], [Pet]), [Name] ([Face Recog.]).

Detailed information display

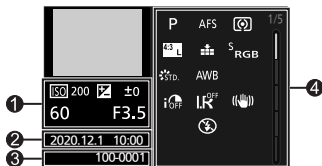

- ① Recording information (basic)
- ② Recording date and time (→45)
- ③ Folder/file number (→439)
- ④ Recording information (advanced)

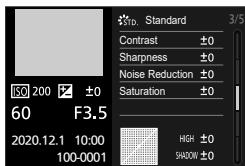
Photo style,
Highlight shadow display

White balance display



Histogram display

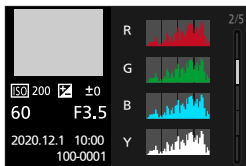

Lens information display



Message Displays

Meanings of main messages displayed on the camera screen, and response methods.

❖ Card

[Memory Card Error]/[Format this card?]

- It is a format that cannot be used with the camera.
Either insert another card, or back up any necessary data before formatting. (→40)

[Memory Card Error]/[This memory card cannot be used]

- Use a card compatible with the camera. (→24)

[Insert SD card again]/[Try another card]

- Unable to access the card. Reinsert the card.
- Insert a different card.

[Read Error]/[Write Error]/[Please check the card]

- Failure to read or write data.
Turn off the camera, reinsert the card, and then turn it on again.
- The card may be broken.
- Insert a different card.

[Recording was cancelled due to the limitation of the writing speed of the card]

- Insufficient card write speed. Use a card of a supported Speed Class. (→24)
- If the recording stops even when you are using a card that meets the specified Speed Class rating, the data writing speed of the card is getting slow. We recommend backing up data, and formatting (→40).

❖ Lens

[The lens is not attached properly. Do not push lens release button while lens is attached.]

- Remove the lens once, and then attach it again without pressing the lens release button. (→41)
Turn on the camera again, and if it is still displaying, contact the dealer.

[Lens attachment failed. Please make sure the lens is attached correctly.]

- Remove the lens from the camera body and gently wipe the contacts on the lens and the camera body using a dry cotton swab.
Attach the lens, turn on the camera again, and if it is still displaying, contact the dealer.

❖ Battery

[This battery cannot be used]

- Use a genuine Panasonic battery.
If this message is displayed even when a genuine Panasonic battery is used, contact the dealer.
- If the terminal of the battery is dirty, remove the dirt and dust from the terminal.

❖ Others

[Some pictures cannot be deleted]/[This picture cannot be deleted]

- Images that do not comply with the DCF standard cannot be deleted.
Back up any necessary data before formatting the card. (→40)

[A folder cannot be created]

- The maximum number of folder numbers has been reached, so new folders cannot be created.
Back up any necessary data before formatting the card. (→40)
After formatting, execute [No.Reset] in the [Setup] menu to reset the folder number to 100. (→123)

[Please turn camera off and then on again]/[System Error]

- Turn off and on the camera.
If the message is displayed even when doing this several times, contact the dealer.

Troubleshooting

First, try out the following procedures (→463 to 473).

If the problem is not resolved, it may be improved by selecting [Reset] (→67) on the [Setup] menu.

Power, Battery

The camera turns off automatically.

- [Economy] is enabled. (→37)

The battery becomes flat too quickly.

- When [4K Pre-Burst] or [Pre-Burst Recording] is set, the battery drains faster. Set these settings only when recording.
- When connected to Wi-Fi, the battery drains quickly.
Turn the camera off frequently such as by using [Economy] (→37).

Recording

Recording stops before finishing.

Cannot record.

Cannot use some functions.

- In high ambient temperatures or if the camera is used for continuous recording, the temperature of the camera will rise.
To protect the camera against a rise in temperature, after [] is displayed, recording will be stopped, and the following functions will not be available for a time. Wait until the camera cools down.
 - [4K PHOTO]
 - [Post Focus]
 - Video recording

Cannot record images.

The shutter will not operate immediately when the shutter button is pressed.

- If [Focus/Release Priority] is set to [FOCUS], then recording will not take place until focus is achieved. (→334)

The recorded image is whitish.

- Images may look whitish when the lens or image sensor gets dirty with fingerprints or similar.
If the lens is dirty, turn the camera off, then wipe the lens surface with a soft, dry cloth.
For information about how to clean the image sensor, refer to page 475.

The recorded image is too bright or dark.

- Ensure AE Lock is not set where it is not appropriate. (→210)

Multiple images are recorded at once.

- When drive mode is set to [📷] (Burst), pressing and holding the shutter button will take burst pictures. (→157)
- When [Bracket] is set, then pressing the shutter button records multiple images while automatically changing the settings. (→195)

The subject is not focused properly.

- Confirm the following details:
 - Is the subject outside of the focus range?
 - Is [Shutter AF] set to [OFF]? (→331)
 - Is [Focus/Release Priority] set to [RELEASE]? (→334)
 - Is AF Lock (→210) set where it is not appropriate?

The recorded image is blurred.

The image stabilizer is not effective.

- The shutter speed will become slower and the image stabilizer function may not work properly when recording in dark places.
In these cases, use a tripod and the self-timer when recording.

The recorded image looks rough.**Noise appears on the picture.**

- Try the following:
 - Reduce the ISO sensitivity. (→212)
 - Increase [Noise Reduction] of [Photo Style] to the positive direction, or adjust each item other than [Noise Reduction] to the negative direction. (→222)
 - Set [Long Shtr NR] to [ON]. (→320)

The subject appears distorted on the image.

- When a moving subject is recorded while using the following functions, the subject may appear distorted in the picture:
 - [ESHTR]
 - Video recording
 - [4K PHOTO]

This is a characteristic of the MOS sensor that is the image sensor of the camera, and is not a malfunction.

Striping or flicker may appear under lighting such as fluorescent or LED lighting.

- This is characteristic of MOS sensors which serve as the camera's pickup sensors. This is not a malfunction.
- When using the electronic shutter (→202), lowering the shutter speed may reduce the effect of the horizontal stripes.
- If flicker or horizontal stripes are noticeable when recording video, this can be mitigated by fixing the shutter speed. Either set [Flkr Decrease] (→329), or record in [Ⓜ] mode (→244).

**Stripes appear in high ISO sensitivity.**

- Stripes may appear in high ISO sensitivity or depending on the lens you use. Decrease the ISO sensitivity. (→212)

The brightness or coloring of the recorded image is different from the actual scene.

- When recording under lighting such as fluorescent or LED lighting, increasing the shutter speed may introduce slight changes to brightness or coloring. These are a result of the characteristics of the light source and do not indicate a malfunction.
- When recording subjects in extremely bright locations or recording under lighting such as fluorescent, LED, mercury, or sodium lighting, the coloring or screen brightness may change or horizontal striping may appear on the screen.

Bright spot not in subject is recorded.

- Pixels may be missing from the image sensor.
Perform [Pixel Refresh]. (→359)

Video

Cannot record videos.

- When using a large capacity card, you may not be able to record for a while after turning on the camera.

Video recording stops in the middle.

- Recording video requires a card of a supported speed class. Use a compatible card. (→24)

Playback sound of the video is small.

- This camera has a wide dynamic range to improve the sound quality and can play a wide range of sounds. For that reason, depending on the environment recorded, the playback sound may feel small but this is not a malfunction.

In videos, abnormal clicking and buzzing sounds are recorded.**The recorded audio is very quiet.**

- Depending on the recording conditions or the lens used, the sound of aperture and focus actions may be recorded in videos.
You can set the focus operation during video recording to [OFF] in [Continuous AF] (→259).
- Do not block the microphone hole during video recording.

An operation sound is recorded in a video.

- We recommend setting the [MF] mode and record with touch operation if you are bothered about the operation sounds during recording. (→246)

Parts that are not in focus are indicated with Peaking.

- When you are using a [Photo Style] setting which uses an adjusted gamma curve, such as [V-Log L], the camera may incorrectly detect noise on images as contrast and indicate it with Peaking. We recommend checking focus with MF Assist before recording.

Lens

When the lens is attached to another digital camera, manual focus operation cannot be performed.

- You can use Manual Focus with the interchangeable lens (H-FS12032) only if your model is compatible with the lens.
Refer to the support website below for details:
<http://panasonic.jp/support/global/cs/dsc/>
(This Site is English only.)



Playback

Cannot play back.

There are no recorded pictures.

- Folders and images processed on a PC cannot be played on the camera. We recommend using the software "PHOTOfunSTUDIO" to write images from the PC to the card.
- Some images are not displayed when the [Playback Mode] is set. Set to [Normal Play]. (→361)

Red part of the recorded image has changed color to black.

- When Red-Eye Removal ([] or []) is performed, red parts may be corrected to black. We recommend recording images with the flash mode set to [] or [Red-Eye Removal] set to [OFF]. (→233)

Monitor/Viewfinder

The monitor/viewfinder turns off when the camera is turned on.

- If no operations are performed during the set time period, [Auto LVF/Monitor Off] (→37) is activated, and the monitor/viewfinder turns off.
- When an object or your hand is positioned near the eye sensor, the monitor display may switch to the viewfinder display.

It may flicker for an instant or the brightness of the screen may change significantly for an instant.



- This occurs when the shutter button is pressed halfway, or when the subject brightness changes, making the lens aperture change. This is not a malfunction.

Cannot switch between the monitor and viewfinder even when [LVF] is pressed.

- In Self Shot Mode, the display automatically switches to monitor display, and the [LVF] and eye sensor are disabled.

Flash

The flash does not fire.

- The flash becomes unavailable in the following cases.
 - The flash is closed.
 - Flash set to [] (Forced Flash Off). (→229)
- The flash does not fire when using the following functions:
 - [] mode
 - Video recording (→238), [4K PHOTO] (→162), [Post Focus] (→176)
 - [ESHTR] (→202)
 - [Silent Mode] (→201)
 - [Filter Settings] (→224)

Wi-Fi Function

A Wi-Fi connection cannot be established.

Radio waves get disconnected.

Wireless access point is not displayed.

General tips for using a Wi-Fi connection

- Use within the communication range of the device to be connected.
- Usage near devices that utilize the 2.4 GHz frequency such as microwave ovens and cordless telephones may result in the radio wave being lost.
Use the camera at a sufficient distance from these devices.
- When the remaining battery level is low, it may not be possible to connect to or maintain communication with other devices.
(A message such as [Communication error] is displayed.)
- If you place the camera on a metal table or shelf, the radio waves may be adversely affected. In such cases, you may not be able to establish a connection.
Move the camera away from the metal surface.

Wireless access point

- Confirm that the connected wireless access point can be used.
- Confirm the radio wave conditions of the wireless access point.
 - Move the camera closer to the wireless access point.
 - Change the location and angle of the wireless access point.
- Depending on the wireless access point, the radio wave may not be displayed even though it is present.
 - Turn off and then on the wireless access point.
 - If the wireless channel of the wireless access point cannot be set automatically, manually set the channel supported by the camera.
 - If the wireless access point SSID is set not to broadcast, it may not be detected.
Enter the SSID, and then connect. (→420)
- Depending on the wireless access point, connection may be automatically disconnected after specific time has passed.
Reconnect the connection again.

Connection to a wireless access point cannot be established.

- The wireless access point information set on the camera is wrong.
Check the authentication type and encryption key. (→420)
- Radio waves from other devices may block the connection to a wireless access point.
Check the status of other devices that are connected to the wireless access point as well as the status of other wireless devices.

(iOS devices) Wi-Fi connection attempt fails.

- Follow the message displayed to allow connection to the camera. If you still cannot connect, select the SSID of the camera on the Wi-Fi setup screen of the smartphone to connect. If the SSID is not displayed, turn off and on the camera, then perform the connection settings again.

Connection to a smartphone via Wi-Fi cannot be established.

- Change the access point to connect to in the smartphone Wi-Fi settings to the camera.

When trying to connect to a PC by Wi-Fi, this does not recognize the user name and password, and connection is not possible.

- Depending on the version of the OS, there are two types of user account (local account/Microsoft account).
Ensure you use the local account user name and password.

The PC is not recognized when I use a Wi-Fi connection.

The camera cannot be connected to the PC using the Wi-Fi function.

- At the time of purchase, this camera is set to use a workgroup name of "WORKGROUP".
If you have changed the workgroup name of the PC, this will not be recognized. In the [Wi-Fi Setup] menu, [PC Connection], change the workgroup name of the PC to which to connect. (→427)
- Check that the login name and password are correctly typed.
- When the clock settings of the PC connected to the camera differs considerably from those of the camera, the camera cannot be connected to the PC depending on the OS.

It takes time to transmit an image to the web service.

Transmission of the image fails midway.

Some images cannot be transmitted.

- Is the size of the image too large?
 - Reduce the image size at [Size] (→425), and then send.
 - Transmit after dividing the video with [Video Divide] (→290).
- File format of the video that can be sent differs depending on the destination. (→402)

I have forgotten the password for the Wi-Fi.

- Reset network settings. (→359)
However, all information set in [Wi-Fi Setup] and [Bluetooth] will also be reset. (With the exception of [LUMIX CLUB])

TV, PC, Printer

No image on the TV.

The TV screen is blurry or not colored.

- Confirm the connection with the TV. (→434)

VIERA Link is not working.

- Check that the [VIERA Link] of the camera is set to [ON]. (→358)
- Check the VIERA Link setting on the connected device.
- Turn off and on the camera.

Cannot communicate with the PC.

- Set the [USB Mode] of the camera to [PC(Storage)]. (→357)
- Turn the camera off and on.

Cannot print when the camera is connected to a printer.

- Pictures cannot be printed using a printer that does not support PictBridge.
- Set the camera's [USB Mode] to [PictBridge(PTP)]. (→357)

Others

There is rattling noise from the lens when the camera is turned on or off, or when the camera is swung.

There is a sound from the lens when recording.

- This is the sound of the lens moving and aperture operation. It is not a malfunction.

An unreadable language was selected by mistake.

- Reselect the language from the menu using the following procedure:

 → [] → [] → Select desired language (→358)

The camera becomes warm.

- The camera surface and back of the monitor may become warm during use, but this does not indicate a problem with performance or quality.

Cautions for Use

❖ The camera

Keep this unit as far away as possible from electromagnetic equipment (such as microwave ovens, TVs, video games etc.).

- If you use this unit on top of or near a TV, the pictures and/or sound on this unit may be disrupted by electromagnetic wave radiation.
- Do not use this unit near cell phones because doing so may result in noise adversely affecting the pictures and/or sound.
- Recorded data may be damaged, or pictures may be distorted, by strong magnetic fields created by speakers or large motors.
- Electromagnetic wave radiation may adversely affect this unit, disturbing the pictures and/or sound.
- If this unit is adversely affected by electromagnetic equipment and stops functioning properly, turn this unit off and remove the battery or disconnect AC adaptor. Then reinsert the battery or reconnect AC adaptor and turn this unit on.

Do not use this unit near radio transmitters or high-voltage lines.

- If you record near radio transmitters or high-voltage lines, the recorded pictures and/or sound may be adversely affected.

Always use the supplied cords and cables.

If you use optional accessories, use the cords and the cables supplied with them.

Do not extend the cords or the cables.

Do not keep objects such as credit cards that may be influenced magnetically close to this unit. The data on these objects may become corrupted and unusable.

Do not spray the camera with insecticides or volatile chemicals.

- If the camera is sprayed with such chemicals, the body of the camera may be damaged and the surface finish may peel off.

Do not keep products made of rubber, PVC or similar materials in contact with the camera for a long period of time.**❖ Cleaning****Before cleaning the camera, remove the battery or the DC Coupler, and disconnect the power plug from the electrical outlet. Then wipe the camera with a dry, soft cloth.**

- When the camera is soiled badly, it can be cleaned by wiping the dirt off with a wrung wet cloth, and then with a dry cloth.
- Do not use solvents such as benzene, thinner, alcohol, kitchen detergents, etc., to clean the camera, since it may deteriorate the external case or the coating may peel off.
- When using a chemical cloth, be sure to follow the accompanying instructions.

❖ Dirt on the image sensor

If dirt gets inside the mount when changing lenses, depending on the recording conditions, it may adhere to the image sensor and appear on the recorded picture.

To prevent debris or dust adhering to internal parts of the body, avoid changing the lens in a dusty environment and always fit the body cap or a lens when storing the camera.

Remove any dirt on the body cap before attaching it.

Removing dirt on the image sensor

The image sensor is very precise and delicate, so be sure to observe the following when you do have to clean it yourself.

- Blow dust off the surface of the image sensor using a commercially available blower. Do not blow the dust off with excessive power.
- Do not put the blower brush further inside than the lens mount as the image sensor may get scratched.
- Do not use any objects except a blower brush to clean the image sensor.
- If you cannot remove the dirt or dust with the blower, consult the dealer or Panasonic.

❖ Cleaning the Viewfinder

- As the eye cup cannot be removed, blow away the dust on the viewfinder surface with a blower (commercially available), gently wipe it with a dry and soft cloth, and be careful not to remove it.
- If you wipe the eye cup too hard and it is removed, consult the dealer or Panasonic.

❖ Monitor/Viewfinder

- Do not push hard on the monitor.
This may cause irregular coloration or malfunction.
- Extremely high precision technology is employed to produce the monitor/viewfinder screen. However there may be some dark or bright spots, or spots that light constantly (red, blue, or green) on the screen.
This is not a malfunction.
Though the monitor/viewfinder screen parts are produced with highly controlled precision technology, some pixels may be inactive or always lit.
The spots will not be recorded on images on a card.

❖ Lens

- Do not press the lens with excessive force.
- Do not leave the camera with the lens facing the sun as rays of light from the sun may cause it to malfunction. Also, be careful when placing the camera outside or near a window.
- When there is dirt (water, oil, and fingerprints, etc.) on the surface of the lens, the picture may be affected. Lightly wipe the surface of the lens with a soft, dry cloth before and after taking pictures.
- Do not place the lens mount facing downwards. Do not allow the lens mount contacts (A) to become dirty.



❖ Battery

The battery is a rechargeable lithium ion battery. It is highly sensitive to temperature and humidity, and the effect on performance increases as the temperature rises or drops.

Keep the contacts of the charger and battery clean.

- Wipe them with a dry cloth if they get dirty.



Always remove the battery after use.

- Place the removed battery in a plastic bag, etc., and keep away from metallic objects (clips, etc.) for storage or transport.

If you drop the battery accidentally, check to see if the body of the battery and the contacts are deformed.

- Damage to the camera will result if a battery with deformed contacts is inserted into the camera.

Dispose of unusable battery.

- The battery has a limited life.
- Do not throw the battery into fire because it may cause an explosion.
- The unusable battery should be discarded in accordance with battery recycling laws. Call the RBRC hotline at 1-800-822-8837 for information.

Do not allow battery terminals to come into contact with metal objects (such as necklaces, hairpins, etc.).

- This can cause short-circuiting or heat generation and you may be badly burned if you touch a battery.

❖ AC Adaptor

- The [CHARGE] light may blink under the influence of static electricity or electromagnetic wave, depending on the charging environment. This phenomenon has no effects on charging.
- If you use the AC adaptor near a radio, the radio reception may be disturbed. Keep the AC adaptor 1 m (3.3 feet) or more away from radio.
- During usage, the AC adaptor may emit an electrical hum; this is not a malfunction.
- After use, be sure to disconnect the power plug from the electrical outlet. (A very small amount of current is consumed if it is left connected.)

❖ Card

Do not leave the card in areas with high temperatures, direct sunlight, or areas prone to electromagnetic waves and static.

Do not bend or drop the card.

Do not subject the card to strong vibration.

- Otherwise, the card and recorded data may be damaged.
- Put the card in the card case or the storage bag after use and when storing or carrying the card.
- Do not allow dirt, water or other foreign objects to get into the contacts on the card. Additionally, do not touch the contacts with your hands.

❖ Personal Information

Personal information is stored within the camera and in recorded images. We recommend that you enhance security by setting a Wi-Fi password and Wi-Fi function lock to protect personal information. (→427, 428)

- Images may contain information that can be used to identify the user, such as recording dates and times, and location information.
Confirm details carefully before uploading images to a web service.

Disclaimer

- Information including personal information may be altered or vanish due to erroneous operation, effect of static electricity, accident, malfunction, repair, or other handlings.
Please note in advance that Panasonic is not liable in any way for any direct or indirect damage from the alteration or vanishing of information or personal information.

When requesting a repair or transferring/disposing of the camera

- After making a copy of personal information, be sure to delete information, including personal information, such as wireless LAN connection settings that you have registered or saved within the camera with [Reset Network Settings] (→359), and [Delete account] ([LUMIX CLUB]). (→431)
- Reset the settings to protect the personal information. (→67)
- Remove the card from the camera.
- Settings may return to factory default when camera is repaired.
- Please contact the dealer where you purchased the camera or Panasonic if above operations are not possible due to malfunction.

Points to remember when disposing of/transferring the memory card

Format or delete using the camera or a PC will only modify the file management information, so it will not delete the data in the card completely.

We recommend physically destroying the card or using commercially available PC data deletion software to delete the card data completely when disposing of/transferring the card.

You are responsible for handling of data on cards.

❖ When Not Using the Camera for a Long Period of Time

- Ensure you remove the battery and card from the camera.
If the battery is left in the camera, it may over-discharge, and be rendered unusable even after charging.
- Store the battery in a cool and dry place with a relatively stable temperature.
(Recommended temperature: 15 °C to 25 °C (59 °F to 77 °F); recommended humidity: 40%RH to 60%RH)
- If storing for a long period of time, it is recommended that the battery be charged once per year, fully drained in the camera, then removed from the camera and then stored again.
- We recommend storing the camera with a desiccant (silica gel) when you keep it in a closet or a cabinet.
- Check all the parts before recording when you have not used the camera for a long period of time.

❖ Image Data

- Recorded data may be damaged or lost if the camera breaks down due to inappropriate handling.
Panasonic will not be liable for any damage caused due to loss of recorded data.

❖ Tripod/Unipod

- Make sure the tripod/unipod is stable when the camera is attached to it.
- You may not be able to remove the card or the battery when using a tripod or unipod.
- Care is required because tightening the screw excessively may damage the camera, or cause the rating label to come off.
- When using this unit with a large-diameter lens, the lens may come into contact with the pedestal depending on the tripod/unipod. Tightening the screw with the lens and pedestal in contact with each other may damage this unit or the lens. Therefore it is recommended to attach the tripod adaptor (DMW-TA1: optional) before mounting on the tripod/unipod.
- Please also refer to the operating instructions for the tripod/unipod.

❖ **Shoulder Strap**

- If you attach a heavy interchangeable lens to the camera body, do not carry the camera by the shoulder strap.
Hold the camera and the lens when carrying them.

❖ **Wi-Fi Function**

Use the camera as a wireless LAN device

When using devices or computer systems that require more reliable security than wireless LAN devices, ensure that the appropriate measures are taken for safety designs and defects for the systems used. Panasonic will not take any responsibility for any damage that arises when using the camera for any purpose other than as a wireless LAN device.

Use of the Wi-Fi function of the camera is presumed to be in countries where it is sold

There is the risk that the camera violates the radio wave regulations if used in countries other than those where it is sold, and Panasonic takes no responsibility for any violations.

There is the risk that data sent and received via radio waves may be intercepted

Please note that there is the risk that data sent and received via radio waves may be intercepted by a third party.

Do not use the camera in areas with magnetic fields, static electricity or interference

- Do not use the camera in areas with magnetic fields, static electricity or interference, such as near microwave ovens.
These may cause the interruption of the radio waves.
- Using the camera near devices such as microwave ovens or cordless telephones that use the 2.4 GHz radio wave band may cause a decrease in performance in both devices.

Do not connect to the wireless network you are not authorized to use

When the camera utilizes its wireless LAN function, wireless networks (SSID) that you are not authorized to use may be displayed, however do not attempt to connect to the network as it may be considered as an unauthorized access.

Number of Pictures That Can Be Taken and Available Recording Time with the Battery

Listed below are the numbers of pictures that can be taken and the time lengths available for recording when the supplied battery is being used.

- The number of pictures that can be taken is according to the CIPA (Camera & Imaging Products Association) standards.
- Using a Panasonic SDHC memory card.
- The values listed are approximate.

❖ Recording Pictures (When using monitor)

When the interchangeable lens (H-FS12032) is used	
Number of recordable pictures	270

❖ Recording Pictures (When using viewfinder (LVF))

When the interchangeable lens (H-FS12032) is used	
Number of recordable pictures	250 (900)

- The numbers in parentheses indicate the values that result when [Time] in [Power Save LVF Shooting] is set to [1SEC] and the [Power Save LVF Shooting] function works as intended.

(Based on the test conditions derived from the CIPA standard and specified by Panasonic)

❖ Recording Videos (When Using the Monitor)

- Recording with picture quality set to [4K/100M/30p].

When the interchangeable lens (H-FS12032) is used	
Continuous available recording time (minutes)	80
Actual available recording time (minutes)	40

- Recording with picture quality set to [FHD/28M/60p].

When the interchangeable lens (H-FS12032) is used	
Continuous available recording time (minutes)	90
Actual available recording time (minutes)	45

- Recording with picture quality set to [FHD/24M/24p].

When the interchangeable lens (H-FS12032) is used	
Continuous available recording time (minutes)	130
Actual available recording time (minutes)	65

- Actual available recording time is the time available for recording when repeating actions such as turning the camera on and off, starting/stopping recording, etc.

❖ Playback (When Using the Monitor)

When the interchangeable lens (H-FS12032) is used	
Playback time (minutes)	220



- The number of pictures that can be taken and the available recording time vary depending on the surrounding environment and the usage conditions. For example, these will reduce in the following case:
 - When the flash is used repeatedly.
 - In low-temperature environments, such as on ski slopes.
- If the usage duration drops significantly even when the battery is fully charged, then the battery is at the end of its service life. Replace with a new battery.







Number of Still Images That Can Be Taken and Video Recording Time with Cards

Listed below are the numbers of pictures and the time lengths of videos that can be recorded on a card.

- The values listed are approximate.

❖ Number of Still Images That Can Be Taken

- When [Aspect Ratio] is set to [4:3]

[Picture Size]	L (20M)		M (10M)		S (5M)	
[Quality]		[RAW 		[RAW 		[RAW 
16 GB	1450	450	2630	520	4600	570
32 GB	2910	900	5280	1050	9220	1150
64 GB	5810	1810	10510	2110	17640	2290
128 GB	11510	3590	20810	4180	34940	4550

❖ Video Recording Time

- “h” is an abbreviation for hour, “m” for minute and “s” for second.
- Video recording time is the total time of all videos that have been recorded.

[Rec Quality]	[4K/100M/30p] [4K/100M/24p]	[FHD/28M/60p]	[FHD/20M/30p]	[FHD/24M/24p]	[HD/10M/30p]
16 GB	20m00s	1h10m	1h35m	1h25m	3h05m
32 GB	41m00s	2h25m	3h15m	2h50m	6h20m
64 GB	1h25m	5h00m	6h40m	5h50m	12h45m
128 GB	2h45m	9h55m	13h15m	11h35m	25h20m



- Depending on the recording conditions and the type of card, number of still images that can be taken, video recording time vary.
- [9999+] is displayed on the recording screen if the remaining number of still images that can be taken is 10000 or more.
- The continuous recordable time for videos is displayed on the screen.

List of Functions That Can Be Set in Each Recording Mode

Menu		iA	iA+	P	A	S	M	⊞	S&Q	SCN	↺
📷 [Rec] menu											
[Aspect Ratio]		✓	✓	✓	✓	✓	✓			✓	✓
[Picture Size]		✓	✓	✓	✓	✓	✓			✓	✓
[Quality]			✓	✓	✓	✓	✓			✓	✓
[Focus Mode]		✓	✓	✓	✓	✓	✓			✓	✓
[AF Sensitivity(Photo)]				✓	✓	✓	✓			✓	✓
[Photo Style]			✓	✓	✓	✓	✓			✓	
[Filter Settings]	[Filter Effect]			✓	✓	✓	✓				
	[Simultaneous Record w/o Filter]			✓	✓	✓	✓				
[Color Space]			✓	✓	✓	✓	✓			✓	
[Metering Mode]				✓	✓	✓	✓				✓
[Highlight Shadow]				✓	✓	✓	✓				
[i.Dynamic]				✓	✓	✓	✓			✓	
[i.Resolution]				✓	✓	✓	✓			✓	✓
[Flash]			✓	✓	✓	✓	✓			✓	
	[Flash Mode]		✓	✓	✓	✓	✓			✓	
	[Flash Synchro]			✓	✓	✓	✓				
	[Flash Adjust.]			✓	✓	✓	✓			✓	
	[Auto Exposure Comp.]			✓	✓	✓	✓			✓	
	[Wireless]			✓	✓	✓	✓				
	[Wireless Channel]			✓	✓	✓	✓				
	[Communication Light]			✓	✓	✓	✓				
	[Wireless Setup]			✓	✓	✓	✓				
[Red-Eye Removal]				✓	✓	✓	✓			✓	✓

Menu				P	A	S	M		S&Q	SCN	
[ISO Sensitivity (photo)]	[ISO Auto Lower Limit Setting]			✓	✓	✓	✓			✓	
	[ISO Auto Upper Limit Setting]			✓	✓	✓	✓			✓	
[Min. Shtr Speed]				✓	✓						
[Long Shtr NR]				✓	✓	✓	✓			✓	✓
[Shading Comp.]				✓	✓	✓	✓			✓	✓
[Diffraction Compensation]				✓	✓	✓	✓			✓	✓
[Stabilizer]	[Operation Mode]		✓	✓	✓	✓	✓			✓	✓
	[E-Stabilization (Video)]		✓	✓	✓	✓	✓			✓	✓
[Ex. Tele Conv.] ([Rec])			✓	✓	✓	✓	✓			✓	✓
[Digital Zoom]				✓	✓	✓	✓				✓
[Burst Rate]		✓	✓	✓	✓	✓	✓			✓	✓
[4K PHOTO]	[Rec Method]	✓	✓	✓	✓	✓	✓			✓	✓
	[Pre-Burst Recording]	✓	✓	✓	✓	✓	✓			✓	✓
[Self Timer]		✓	✓	✓	✓	✓	✓			✓	✓
[Time Lapse Shot]		✓	✓	✓	✓	✓	✓			✓	✓
[Stop Motion Animation]		✓	✓	✓	✓	✓	✓			✓	✓
[Live View Composite]							✓				
[Silent Mode]		✓	✓	✓	✓	✓	✓			✓	✓
[Shutter Type]			✓	✓	✓	✓	✓			✓	✓
[Shutter Delay]			✓	✓	✓	✓	✓			✓	✓
[Bracket]			✓	✓	✓	✓	✓			✓	✓
[HDR]				✓	✓	✓	✓				
[Multi Exp.]	[Auto Gain]			✓	✓	✓	✓				
	[Overlay]			✓	✓	✓	✓				

Menu		IA	IA+	P	A	S	M	M	S&Q	SCN	↺
[Motion Picture] Menu											
[Rec Quality]		✓	✓	✓	✓	✓	✓	✓		✓	✓
[Snap Movie]		✓	✓	✓	✓	✓	✓	✓		✓	✓
[Focus Mode]		✓	✓	✓	✓	✓	✓	✓	✓	✓	✓
[Continuous AF]			✓	✓	✓	✓	✓	✓	✓	✓	✓
[AF Custom Setting(Video)]			✓	✓	✓	✓	✓	✓	✓	✓	✓
[Photo Style]			✓	✓	✓	✓	✓	✓	✓	✓	
[Filter Settings]	[Filter Effect]			✓	✓	✓	✓	✓			
	[Simultaneous Record w/o Filter]			✓	✓	✓	✓				
[Luminance Level]			✓	✓	✓	✓	✓	✓	✓	✓	✓
[Metering Mode]				✓	✓	✓	✓	✓	✓		✓
[Highlight Shadow]				✓	✓	✓	✓	✓	✓		
[i.Dynamic]				✓	✓	✓	✓	✓	✓	✓	
[i.Resolution]				✓	✓	✓	✓	✓	✓	✓	✓
[ISO Sensitivity (video)]	[ISO Auto Lower Limit Setting]							✓	✓		
	[ISO Auto Upper Limit Setting]							✓	✓		
[Diffraction Compensation]				✓	✓	✓	✓	✓	✓	✓	✓
[Stabilizer]	[Operation Mode]		✓	✓	✓	✓	✓	✓	✓	✓	✓
	[E-Stabilization (Video)]		✓	✓	✓	✓	✓	✓		✓	✓
[Flkr Decrease]				✓	✓	✓	✓				
[Ex. Tele Conv.] ([Motion Picture])			✓	✓	✓	✓	✓	✓		✓	✓
[Digital Zoom]				✓	✓	✓	✓	✓			✓
[Picture Mode in Rec.]				✓	✓	✓	✓			✓	✓
[Self Timer]		✓	✓	✓	✓	✓	✓	✓	✓	✓	✓
[Sound Rec Level Disp.]			✓	✓	✓	✓	✓	✓		✓	✓
[Sound Rec Level Adj.]			✓	✓	✓	✓	✓	✓		✓	✓
[Wind Noise Canceller]			✓	✓	✓	✓	✓	✓		✓	✓

Menu	IA	IA+	P	A	S	M	⊞M	S&Q	SCN	↺
[Wind Cut]*1		✓	✓	✓	✓	✓	✓		✓	✓
[Lens Noise Cut]*2		✓	✓	✓	✓	✓	✓		✓	✓
[Built-in Mic]	✓	✓	✓	✓	✓	✓	✓		✓	✓
[Built-in Mic Indicator]	✓	✓	✓	✓	✓	✓	✓		✓	✓
[Special Mic.]*3	✓	✓	✓	✓	✓	✓	✓		✓	✓

*1 This item is available only when using an external microphone (optional).

*2 This item is available only when using an interchangeable lens supporting power zoom.

*3 This item is available only when using stereo shotgun microphone (DMW-MS2: optional).

Specifications

The specifications are subject to change for performance enhancement.

Digital camera body (DC-G100):

Information for your safety

Power source:	8.4 V $\overline{=}$
Power consumption:	2.9 W (when recording with the monitor), 2.0 W (when playing back with the monitor) <When using the interchangeable lens (H-FS12032)>

Type	
Type	Digital Single Lens Mirrorless camera
Recording media	SD memory card / SDHC memory card*1 / SDXC memory card*1 *1 Compliant with UHS-I UHS Speed Class 3
Lens mount	Micro Four Thirds mount
Image sensor	
Image sensor	4/3" Live MOS sensor, a total of 21,770,000 pixels, primary color filter
Effective number of pixels of the camera	20,300,000 pixels
Recording format for still images	
File format for still images	JPEG (DCF compliant, Exif 2.31 compliant) / RAW
File format for 4K photos	MP4 (H.264/MPEG-4 AVC, AAC (2ch))

Picture size (pixels)	<p>When the aspect ratio setting is [4:3] [L]: 5184×3888, [M]: 3712×2784, [S]: 2624×1968 4K photo: 3328×2496</p> <p>When the aspect ratio setting is [3:2] [L]: 5184×3456, [M]: 3712×2480, [S]: 2624×1752 4K photo: 3504×2336</p> <p>When the aspect ratio setting is [16:9] [L]: 5184×2920, [M]: 3840×2160, [S]: 1920×1080 4K photo: 3840×2160</p> <p>When the aspect ratio setting is [1:1] [L]: 3888×3888, [M]: 2784×2784, [S]: 1968×1968 4K photo: 2880×2880</p>
Quality	Fine / Standard / RAW+Fine / RAW+Standard / RAW
Recording format for video	
Video format	MP4 (H.264/MPEG-4 AVC, AAC (2ch))
Image quality for video	For details, refer to page 239 .
Viewfinder	
System	Aspect ratio 4:3, 0.4 inches, approx. 3,680,000 dots equivalent, Color LCD Live Viewfinder (field of view ratio about 100%)
Magnification	Approx. 0.73× (35 mm film camera equivalent) (−1.0 m ⁻¹ 50 mm at infinity, with aspect ratio set to [4:3])
Eye point	Approx. 20 mm (at −1.0 m ⁻¹)
Diopter adjustment range	−4.0 to +2.0 diopter

Monitor	
System	Aspect ratio 3:2, 3.0 inches, approx. 1,840,000 dots monitor, capacitive touch screen (field of view ratio about 100%)
Focus	
AF type	TTL type based on image detection (Contrast AF)
Focus mode	AFS / AFF / AFC / MF
AF mode	Face/Eye Detection, Tracking, 49-area-focusing, Custom Multi, 1-area-focusing, Pinpoint-focusing (Focus area selection is possible by touching.)
Exposure control	
Light metering system, Light metering mode	1728-zone metering, multi-metering / center-weighted metering / spot metering
Metering range	EV 0 to EV 18 (F2.0 lens, ISO100 conversion)
Exposure	Program AE (P) / Aperture-Priority AE (A) / Shutter-Priority AE (S) / Manual Exposure (M)
Exposure compensation	1/3 EV steps, ± 5 EV
ISO sensitivity (standard output sensitivity)	AUTO / Intelligent ISO / 200 to 25600, When [Extended ISO] is set: AUTO / 100 to 25600, 1/3 EV steps
White balance	
AWB / AWBc / AWBw / Daylight / Cloudy / Shade / Incandescent lights / Flash / White set 1, 2, 3, 4 / Color temperature 1, 2, 3, 4	

Shutter		
Format	Electronically-controlled, Single curtain focal-plane shutter	
Shutter speed	Pictures: Electronic front curtain: Time (max. approx. 60 seconds), 60 seconds to 1/500 of a second Electronic shutter: 1 second to 1/16000 of a second Videos: 1/25*2 of a second to 1/16000 of a second *2 When [Exposure Mode] is set to [M] in [P/M] mode and focus mode is set to [MF], this can be set up to 1/2	
Burst recording		
Electronic front curtain	High speed	6 frames/second ([AFS], [MF]) / 5 frames/second ([AFF], [AFC])
	Medium speed	4 frames/second
	Low speed	2 frames/second
Electronic shutter	High speed	10 frames/second
	Medium speed	4 frames/second
	Low speed	2 frames/second
Maximum number of frames recordable	Without RAW files: 480 frames or more With RAW files: 20 frames or more (When recording is performed under the test conditions specified by Panasonic)	
Minimum illumination		
Approx. 9 lx (when i-Low light is used, the shutter speed is 1/30th of a second) <When the Interchangeable lens (H-FS12032) is used>		

Flash	
Flash	TTL AUTO Built-in pop up flash GN 5.1 equivalent (ISO200·m) [GN 3.6 equivalent (ISO100·m)]
Flash mode	Auto, Auto/Red-Eye, Forced Flash On, Forced On/Red-Eye, Slow Sync., Slow Sync./Red-Eye, Forced Flash Off
Flash synchronization speed	Equal to or smaller than 1/50 of a second
Flash range	Approx. 0.4 m (1.3 feet) to 4.1 m (13 feet) <When the Interchangeable lens (H-FS12032) is mounted, WIDE, [ISO AUTO] is set>
Zoom	
Digital Zoom	Max. 2x
Extended Tele Conversion	When taking still pictures: Max. 2.0x (When a picture size of [S] is selected.) When recording video: 2.7x (FHD)/4.0x (HD)
Display language	
[ENGLISH]/[DEUTSCH]/[FRANÇAIS]/[ITALIANO]/[ESPAÑOL]/[繁體中文]/[PORTUGUÊS]/[日本語]	
Microphone / Speaker	
Microphone	Stereo
Speaker	Monaural
Interface	
[HDMI]	micro HDMI Type D
[USB/CHARGE]	USB 2.0 (High Speed)/USB 2.0 Micro-B
[MIC]	Ø 3.5 mm stereo mini jack

External dimensions / Mass	
External dimensions	Approx. 115.6 mm (W)×82.5 mm (H)×54.2 mm (D) (4.55" (W)×3.24" (H)×2.13" (D)) (excluding the projecting parts)
Mass (Weight)	Approx. 345 g/0.76 lb (with one card and the battery) Approx. 303 g/0.66 lb (only camera body)
Operating environment	
Recommended operating temperature	0 °C to 40 °C (32 °F to 104 °F)
Permissible relative humidity	10%RH to 80%RH

This camera complies with the "Design rule for Camera File system" (DCF) and "Exchangeable Image File Format" (Exif) standards established by "Japan Electronics and Information Technology Industries Association" (JEITA). The camera cannot play back files that do not comply with the DCF standard. Exif is a file format for pictures which allows recording information, etc. to be added.

Interchangeable Lens	H-FS12032 “LUMIX G VARIO 12–32 mm/F3.5–5.6 ASPH./MEGA O.I.S.”
Focal length	f=12 mm to 32 mm (35 mm film camera equivalent: 24 mm to 64 mm)
Aperture type	7 diaphragm blades/circular aperture diaphragm
Maximum aperture	F3.5 (Wide) to F5.6 (Tele)
Minimum aperture value	F22
Lens construction	8 elements in 7 groups (3 aspherical lenses, 1 ED lens)
In focus distance	0.2 m (0.66 feet) to ∞ (from the focus distance reference line) (focal length 12 mm to 20 mm), 0.3 m (0.98 feet) to ∞ (from the focus distance reference line) (focal length 21 mm to 32 mm)
Maximum image magnification	0.13x (35 mm film camera equivalent: 0.26x)
Optical Image Stabilizer	Available
Mount	Micro Four Thirds mount
Angle of view	84° (Wide) to 37° (Tele)
Filter diameter	37 mm
Max. diameter	Ø 55.5 mm (2.2 inch)
Overall length	Approx. 24 mm (0.94 inch) (from the tip of the lens to the base side of the lens mount when the lens barrel is recessed)
Mass (Weight)	Approx. 67 g/0.15 lb
Recommended operating temperature	0 °C to 40 °C (32 °F to 104 °F)
Permissible relative humidity	10%RH to 80%RH

Tripod grip: DMW-SHGR1

Carrying capacity (Total mass of the loading camera body, lens, battery, and other attached accessories)	Maximum 1.2 kg/2.65 lb
External dimensions (Legs folded)	Approx. 53.7 mm (W)×144.7 mm (H)×45.5 mm (D) (2.11" (W)×5.70" (H)×1.79" (D)) (excluding the projecting parts)
External dimensions (Legs opened)	Approx. 150.5 mm (W)×113.7 mm (H)×133.4 mm (D) (5.93" (W)×4.48" (H)×5.25" (D)) (excluding the projecting parts)
Length of the connection cable	Approx. 160 mm (6.30")
Mass (Weight)	Approx. 102 g/0.22 lb
Recommended operating temperature	0 °C to 40 °C (32 °F to 104 °F)
Permissible relative humidity	10%RH to 80%RH

Index

Numerics

1-Area (AF).....	139
49-Area (AF).....	135
4K Burst.....	163
4K Burst (Wide-angle).....	88
4K burst files.....	168
4K Burst (S/S).....	163
4K Live Cropping.....	247, 312
4K PHOTO.....	162, 321
4K PHOTO Bulk Saving.....	175, 364
4K PHOTO Play.....	295
4K Pre-Burst.....	163
5-Axis Hybrid Image Stabilizer.....	205

A

AC adaptor.....	451, 479
AF.....	126
AF After Countdown.....	348
AF Area Display.....	335
AF Assist Lamp.....	333
AF Custom Setting(Video).....	260, 327
AF Mode.....	129
AF Sensitivity(Photo).....	128
AF/AE Lock.....	210, 331
AF/AE Lock Hold.....	331
AF+AE.....	143
AF+MF.....	336
AFC.....	124
AFF.....	124
AF-ON.....	211
AFS.....	124
Android.....	374
Aperture Bracket.....	198
Aperture Ring Increment.....	348
Aperture-Priority AE mode.....	93

Appetizing Food.....	109
Approved Regulations.....	359
Artistic Nightscape.....	108
Aspect Ratio.....	117, 314
Auto Clock Set.....	354, 397
Auto exposure compensation.....	233, 318
Auto focus.....	126
Auto LVF/Monitor Off.....	37, 355
Auto Marking function.....	174
Auto Review.....	340
Auto Transfer.....	354, 393
Auto White Balance.....	216
Automatic scene detection.....	76
AV device (Wi-Fi Connections).....	412
Available recording time.....	484
Available recording time (for video recording).....	487

B

Backlight compensation.....	75
Backlit Softness.....	107
Battery.....	31, 478
Beep.....	354
Bleach Bypass.....	112
Blinking Highlights.....	344
Bluetooth.....	354, 375
Bracketing.....	195, 323
Bright Blue Sky.....	108
Built-in Mic.....	265
Built-in Mic Indicator.....	266
Built-in microphone setting (Self Shot).....	86
Bulb.....	389
Burst rate.....	159, 321
Burst Shot.....	158

C

Calendar Playback	277
Card	24, 39, 479
Center Marker	344
Center-weighted metering	207
Charge	31
Cinelike D	221
Cinelike V	221
Cleaning	475
Clear Night Portrait	109
Clear Nightscape	108
Clear Portrait	107
Clear Retouch	284
Clear Sports Shot	109
Clock Set	45, 352
Cloud Limit	425
Cloud sync service	416
Color Space	315, 439
Color Tone	222
Communication Light	237, 318
Compression rate	119, 314
Condensation	21
Constant Preview	341
Continuous AF	259, 327
Continuous available recording time	485
Contrast	222
Control dial	53
Cool Night Sky	108
Creating a picture from a video	274
Creative Control menu	313
Creative Control mode	110
Creative Video menu	312
Creative Video mode	244
Cropping	367
Cross Process	112

Custom menu	331
Custom mode	303
Custom Mode menu	304
Custom set memory	303, 352
Cute Dessert	109

D

DC Coupler	451
DCF standard	497
Defocus control function	82, 115
Delete	279
Delete All Images	369
Delete Confirmation	369
Delete Location Data	425
Delete Single	279
Demo Mode	359
Device Name	427
Dial Operation Switch Setup	297, 338
Dial Setting	338
Diffraction Compensation	321
Digital Zoom	155, 321
Diopter adjustment	55
Direct Focus Area	334
Distinct Scenery	108
Drive mode	157
Dynamic Monochrome	112

E

Economy	37, 355
Electronic front curtain	202, 322
Electronic shutter	202, 322
Enlarged Display	275
Entering characters	370
E-Stabilization (Video)	205, 321
Exposure Bracket	198
Exposure compensation	208

-
- Exposure Compensation Display Setting 337
- Exposure Compensation Reset..... 331
- Exposure Meter 345
- Exposure Mode 244, 312
- Expressive 112
- Extended ISO 331
- Extended Tele Conversion
..... 152, 321, 329
- External flash..... 447
- External microphone..... 448
- Eye cup..... 476
- Eye sensor..... 356
- Eye Sensor AF..... 332
- F**
-
- Face Rec Edit..... 364
- Face recognition..... 349
- Face/Eye Detection 131
- Fantasy..... 112
- File number..... 121, 123, 439, 459
- Filter Effect 111, 224, 314
- Filter Settings..... 224, 314
- Firmware update..... 20
- Firmware Version..... 358
- Flash..... 226
- Flash adjustment 231, 318
- Flash Mode..... 227, 318
- Flash setting 227, 318
- Flash Synchro..... 232, 318
- Flicker Decrease..... 329
- Fn button 292
- Fn Button Set..... 293, 337
- Focus..... 126, 259
- Focus Area Set..... 294
- Focus Bracket..... 199
- Focus mode..... 124
- Focus Ring Lock..... 339
- Focus Stacking..... 181
- Focus Switching for Vert/Hor..... 335
- Focus/Release Priority 334
- Folder number 121, 123, 439, 459
- Folder/File Settings..... 121, 359
- Forced Flash Off..... 227
- Format..... 40, 359
- Frame Marker..... 268, 344
- Freeze Animal Motion..... 109
- Front dial..... 53
- G**
-
- Gamma setting (Photo Style) 221
- Glistening Water 108
- Glittering Illuminations 108
- Grain Effect..... 223
- Group image..... 278
- Guide Line 343
- H**
-
- Half Press Release..... 331
- Handheld Night Shot 109
- HDAVI Control™..... 435
- HDMI Info Display (Rec)..... 358
- HDMI micro cable 432, 434, 436
- HDMI Mode (Play)..... 357
- HDMI socket..... 432
- HDR..... 323
- High Dynamic 112
- High Key..... 112
- Highlight Shadow..... 316
- Histogram 343
- Hot shoe cover 447
- I**
-
- i.Dynamic..... 317

-
- i.ISO..... 213
 - i.Resolution..... 317
 - iHandheld Night Shot..... 79, 312
 - iHDR..... 79, 312
 - Image Quality 222
 - Image Stabilizer..... 204, 321
 - Impressive Art..... 112
 - Intelligent Auto menu 312
 - Intelligent Auto mode 74
 - Intelligent Auto Plus Mode 77
 - Intelligent ISO 213
 - iOS..... 374
 - ISO Displayed Setting 337
 - ISO Increments..... 331
 - ISO sensitivity 212
 - ISO Sensitivity (photo)..... 319
 - ISO Sensitivity (video) 262, 328
- ## L
-
- L.Monochrome..... 221
 - L.Monochrome D 221
 - Language..... 358
 - Lens..... 23, 41
 - Lens Fn Button Setting..... 347
 - Lens Noise Cut..... 264
 - Lens Position Resume..... 347
 - Level Gauge 294
 - Level Gauge Adjustment 359
 - Light Composition..... 280
 - Live View Boost..... 341
 - Live View Composite Recording..... 101
 - Location Logging 354, 395
 - Log recording..... 269
 - Long Exposure NR 320
 - Looped Focus Frame 335
 - Low illumination AF..... 127
 - Low Key..... 112
 - Luminance Level 261, 328
 - LUMIX CLUB 428
 - LUMIX Sync..... 374
 - LVF Display Speed 355
 - LVF Luminance..... 356
 - LVF/Monitor Display Set 345
 - LVF/Monitor Display Style 294
 - LVF/Monitor Switch..... 356
- ## M
-
- Manual Exposure mode..... 98
 - Manual focus 146
 - Menu Guide..... 346
 - Metering Mode..... 207, 315
 - MF 124, 146
 - MF Assist..... 336
 - MF Assist Display 336
 - MF Guide..... 345
 - Miniature Effect..... 112
 - Minimum Shutter Speed..... 319
 - Monitor..... 44, 452
 - Monitor Display..... 356
 - Monitor Display Speed 355
 - Monitor Luminance 356
 - Monitor recording information screen
..... 58, 63, 456
 - Monochrome..... 109, 112
 - Monochrome (Photo Style)..... 221
 - Monochrome Live View 340
 - Motion Picture menu..... 327
 - Multi-metering..... 207
 - Multiple Exposure 325
 - My Menu..... 305
 - My Menu Setting..... 306

- N**
-
- Natural (Photo Style) 221
 - Network Address 428
 - No.Reset..... 123, 359
 - Noise Reduction 222
 - Number of pictures that can be taken
..... 484
 - Number of pictures that can be taken
continuously..... 160
 - Number of prints 445
 - Number of still images that can be taken
..... 487
- O**
-
- Old Days..... 112
 - One Point Color 112
 - One Push AE 294
 - Online Manual 352
 - Operation Lock Setting..... 339
 - Optical zoom..... 151
- P**
-
- Page Layout 445
 - Paper Size 445
 - PC connection 407, 427, 438
 - Peaking..... 342
 - Photo Style 221, 314
 - PHOTOfunSTUDIO 441
 - PictBridge 444
 - Picture mode in recording..... 329
 - Picture Size 118, 314
 - Picture Sort..... 368
 - Pinpoint (AF)..... 140
 - Pinpoint AF Setting 332
 - Pixel Refresh 359
 - Play back..... 270
 - Play back picture 270
 - Play back video 272
 - Playback menu 360
 - Playback Mode..... 361
 - Portrait (Photo Style) 221
 - Post-Focus 176
 - Power Save LVF Shooting..... 37, 355
 - Power Zoom Lens 156, 347
 - Pre-Burst Recording..... 165, 321
 - Preview..... 104
 - Print 410, 444
 - Print with Date 445
 - Profile Setup 351
 - Program AE mode 91
 - Program Shift..... 92
 - Protect 362
- Q**
-
- Q.MENU 61, 299, 337
 - Quality 119, 314
 - Quick AF 332
 - Quick menu 61, 299
- R**
-
- Rating 362
 - RAW 119
 - RAW Processing 286, 364
 - Rec Area..... 346
 - Rec Menu 314
 - Rec Quality (Video) 239, 327
 - Rec/Playback Switch 295
 - Recording distance reference..... 150
 - Recording mode 52
 - Recording videos..... 238
 - Recording with Time Lapse Shot
..... 187, 322
 - Red REC Frame Indicator 346

- Red-Eye Removal 233, 319
- Register to Favorite
(Wi-Fi connection) 422
- Relaxing Tone 108
- Remaining display 346
- Remote shooting 387
- Remote Wakeup 354, 396
- Reset 67, 359
- Reset Network Settings 359
- Resize 366
- Restore to default 295
- Retro 112
- Returning from Sleep Mode 354, 390
- Romantic Sunset Glow 108
- Rotate 367
- Rotate Display 368
- Rough Monochrome 112
- S**
-
- S&Q Effect 254
- S&Q Exposure Mode 253
- S&Q Recording Frame Rate 253
- Saturation 222
- Scene Guide menu 313
- Scene Guide mode 105
- Scene Switch 313
- Scenery (Photo Style) 221
- SD Speed Class 24
- Self Shot 348
- Self Shot Mode 83
- Self Timer Auto Off 348
- Self-timer 184, 322
- Send Image (Smartphone)
..... 354, 404, 406
- Sending file format 425
- Sending size 425
- Sepia 112
- Sequence Composition 282
- Setup menu 352
- Shading compensation 320
- Sharpness 222
- Shoulder strap 30
- Shutter AF 331
- Shutter Delay 102, 323
- Shutter Remote Control 389
- Shutter Type 202, 322
- Shutter-Priority AE mode 96
- Silent Mode 201, 322
- Silky Monochrome 112
- Silky Skin 107
- Simultaneous Record w/o Filter
..... 111, 225, 313
- Sleep Mode 37, 355
- Sleep Mode (Wi-Fi) 37, 355
- Slide show 361
- Slow & Quick Menu 253, 313
- Slow & Quick Mode 250
- Snap Movie 255
- Soft Focus 112
- Soft Image of a Flower 109
- Sound recording level adjustment
..... 263, 329
- Sound recording level display 263, 329
- Special Mic 330, 450
- Spot metering 207
- Standard (Photo Style) 221
- Star Filter 112
- Starlight AF 127
- Stereo Shotgun Microphone 330, 448
- Stop Motion Animation 190, 322
- Stop Motion Video 368
- Storage (recorder) 443
- Sunshine 112

T

T (Time)	100
Text Stamp	365
Thumbnail screen	276
Time Lapse Video	368
Title Edit	363
Touch AE	69
Touch AF	68, 142, 339
Touch Pad AF	144, 339
Touch screen	54
Touch Settings	339
Touch Shutter	68
Touch Tab	339
Touch Zoom	153
Toy Effect	112
Toy Pop	112
Tracking (AF)	78, 133
Travel Date	353
Tripod	481
Tripod grip	70
TV Connection	357
TV playback	434

U

UHS Speed Class	24
USB connection cable	33, 357, 433, 438, 443, 444
USB Mode	357
USB/CHARGE socket	33, 433

V

Vertical orientation detection function	49
Video Divide	290, 367
Video rec. button	51, 238, 339
Video Speed Class	24

VIERA Link	358, 435
Viewfinder	55, 356, 452
Vivid	221
Vivid Sunset Glow	108
V-Log L	269

W

Warm Glowing Nightscape	108
Web service	414
White balance	215
White balance adjustment	219
White Balance Bracket	200
Wi-Fi	353, 371
Wi-Fi Function	353, 371
Wi-Fi Function Lock	428
Wi-Fi network settings	354
Wi-Fi Password	427
Wi-Fi Setup menu	353, 427
Wind Cut	330, 450
Wind Noise Canceller	264, 330
Wireless	235, 318
Wireless Channel	235, 318
Wireless Connection Lamp	354, 371
Wireless flash	234
Wireless printing	410
Wireless Setup	236, 318
World Time	352
WPS	418, 421

Z

Zebra Pattern	267, 344
Zoom	151

Trademarks and Licenses



- Micro Four Thirds™ and Micro Four Thirds Logo marks are trademarks or registered trademarks of Olympus Corporation, in Japan, the United States, the European Union and other countries.
- Four Thirds™ and Four Thirds Logo marks are trademarks or registered trademarks of Olympus Corporation, in Japan, the United States, the European Union and other countries.
- SDXC Logo is a trademark of SD-3C, LLC.
- The terms HDMI and HDMI High-Definition Multimedia Interface, and the HDMI Logo are trademarks or registered trademarks of HDMI Licensing Administrator, Inc. in the United States and other countries.
- HDAVI Control™ is a trademark of Panasonic Corporation.
- Adobe is a trademark or registered trademark of Adobe Systems Incorporated in the United States and/or other countries.
- Pentium is a trademark of Intel Corporation in the U.S. and/or other countries.
- Windows is either registered trademark or trademark of Microsoft Corporation in the United States and/or other countries.
- iMovie, Mac, OS X and macOS are trademarks of Apple Inc., registered in the U.S. and other countries.
- App Store is a service mark of Apple Inc.
- Google, Android and Google Play are trademarks of Google LLC.



- The Bluetooth® word mark and logos are registered trademarks owned by Bluetooth SIG, Inc. and any use of such marks by Panasonic Corporation is under license. Other trademarks and trade names are those of their respective owners.
- The Wi-Fi CERTIFIED™ Logo is a certification mark of Wi-Fi Alliance®.
- The Wi-Fi Protected Setup™ Logo is a certification mark of Wi-Fi Alliance®.
- "Wi-Fi®" is a registered trademarks of Wi-Fi Alliance®.
- "Wi-Fi Protected Setup™", "WPA™", and "WPA2™" are trademarks of Wi-Fi Alliance®.
- This product uses "DynaFont" from DynaComware Corporation. DynaFont is a registered trademark of DynaComware Taiwan Inc.
- DLNA, the DLNA Logo and DLNA CERTIFIED are trademarks, service marks, or certification marks of the Digital Living Network Alliance.
- QR Code is a registered trademark of DENSO WAVE INCORPORATED.
- Other names, company names, and product names mentioned in these instructions are trademarks or registered trademarks of the companies concerned.

This product is licensed under the AVC Patent Portfolio License for the personal use of a consumer or other uses in which it does not receive remuneration to (i) encode video in compliance with the AVC Standard ("AVC Video") and/or (ii) decode AVC Video that was encoded by a consumer engaged in a personal activity and/or was obtained from a video provider licensed to provide AVC Video. No license is granted or shall be implied for any other use. Additional information may be obtained from MPEG LA, L.L.C.

See <http://www.mpegla.com>

Firmware Update

■ Firmware Has Been Updated

A firmware update has been made available to improve camera capabilities and to add functionality.

The subsequent sections describe functions that have been added or modified.

Also refer to the “Owner’s Manual”.

- To check the firmware version of the camera, select [Version Disp.] in the [Setup] menu.
- For the latest information on the firmware or to download/update the firmware, visit the following support site:

<https://panasonic.jp/support/global/cs/dsc/>

(English only)

[Click here to move to the cover page of the “Owner’s Manual”.](#)

Firmware Ver. 1.1

[Horizontal Image Flip(Monitor)] and [Vertical Image Flip(Monitor)] Have Been Added to [LVF/Monitor Disp. Set]



It is now possible to set whether the screen flips or not depending on the facing or angle of the monitor during recording.

→ → → [LVF/Monitor Disp. Set] →

Select [Horizontal Image Flip(Monitor)]/[Vertical Image Flip(Monitor)]

[Horizontal Image Flip(Monitor)]	[AUTO]	The screen automatically flips horizontally according to the angle to which the monitor is opened or closed.
	[ON]	The screen is flipped horizontally all the time.
	[OFF]	Screen is not flipped.
[Vertical Image Flip(Monitor)]	[AUTO]	The screen automatically flips vertically according to the angle to which the monitor is rotated.
	[ON]	The screen is flipped vertically all the time.
	[OFF]	Screen is not flipped.

- The default setting is [AUTO].



- The settings for this function are not reflected in the playback screen.