

USER MANUAL

**Ausclimate Cool Seasons 10L
Desiccant Dehumidifier
Model: AU1000DD**

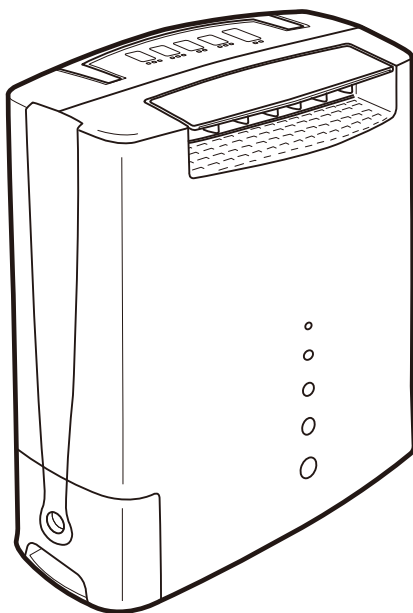

Please read this user manual before operating

IMPORTANT SAFETY INSTRUCTIONS

PLEASE READ ALL INSTRUCTIONS CAREFULLY BEFORE OPERATING.

WARNING - This appliance is intended for use in a domestic or office environment only. Any other use is not recommended by the manufacturer and may cause fire, electrical shocks or other injury to person or property.

When using electrical appliances, basic safety precautions should always be followed:

1. Do not operate the unit with a damaged power cord or power plug, or after it malfunctions or has been dropped or damaged in any way. Seek advice from your retailer or distributor for examination and repair.
2. This unit should always be kept in an upright position to avoid any damage. Locate the unit on a flat stable surface.
3. Check the household voltage to ensure it matches the units rated specification before operating.
4. Operate this unit in an ambient temperature between 1°C and 40°C.
5. Ensure that the air inlets and outlets are not blocked or covered.
6. Do not place the unit too close to curtains or other furnishings - min 40cm.
7. When using the "LAUNDRY MODE" to speed up the drying of wet clothes in the room, please keep the clothing at a safe distance from the unit to prevent water from dripping onto the unit.
8. Never place anything on top of the unit and do not cover with any kind of material while in use.
9. This product is intended for domestic and office use ONLY and not for commercial, industrial or outdoor use.
10. To protect against electrical shocks, do not immerse unit, power cord or power plug in water, or spray with liquids.
11. Never unplug the power cord without pressing the "ON/OFF" key to off first, as this could damage the unit.
12. Always unplug the unit when not in use or moving location. To disconnect from the power supply, grip the plug to pull from the power socket. Never pull by the cord.
13. Always empty the water tank before storing the unit away.
14. Close supervision is necessary when any appliance is used near children and pets.
15. Do not run power cord under carpet, or cover the cord with rugs or runners. Arrange the power cord away from areas where it may be tripped over.
16. Never operate or store the unit in direct sunlight.
17. If authorised by the distributor, repairs may be undertaken by a qualified service technician. Repairs carried out by unqualified people may cause damage to the unit or injury to persons or property and void the warranty.
18. Where possible, don't use an extension power lead as the cable may overheat and cause a risk of fire. Only use an extension lead after ensuring it is in perfect condition.
19. Do not use the unit without the air filter and make sure that the filter is kept clean to avoid malfunction and invalidating the warranty.

This appliance is not intended for use by persons (including children) with reduced physical, sensory or mental capabilities, or lack of experience and knowledge, unless they have been given supervision or instruction concerning use of the appliance by a person responsible for their safety. Children should be supervised to ensure that they do not play with the appliance.

SAVE AND READ THESE IMPORTANT SAFETY INSTRUCTIONS

FEATURES

- **(Non) Compressor dehumidifier** ~ uses desiccant rotor technology
- **Environmentally friendly** with no harmful gasses & quiet in operation
- **Moisture removal** ~ 10 litres/day (20°C, 60%RH)
- **Water tank capacity** ~ 3.8 litres
- **Nano-silver embedded in the filter**
 - ~ kills bacteria on contact improving the quality of air in your home or office
 - ~ Anti-bacteria Nano-silver embedded in each filter string
 - ~ Over 99% anti-bacteria performance
 - ~ The filter may be cleaned by use of vacuum cleaner
 - ~ The filter may also be washed by water and still retain performance
- **Laundry mode** ~ includes power saving setting for warm temperatures & turbo setting for winter
- **Up to 8-hour timer** ~ for added convenience
- **Temperature range for use** ~ 1°C - 40°C
- **Light & portable with carry handle**
- **Removable water bucket with handle**
- **Operating light**
- **Auto restart after power cut**
 - ~ Once the power is restored after a power failure, the appliance will continue to operate at the selected settings prior to the power failure.
- **Wide / Spot adjustable louver**
 - ~ to provide wide, parallel or spot air flow.
- **Automatic louver wide range (max 150°)**
 - ~ 3-stage automatic air swing to meet your needs.
 - ~ Retractable 50° downward sub-louver for drying shoes or ground.

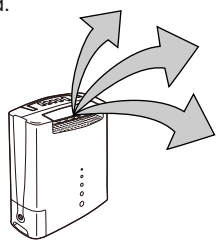
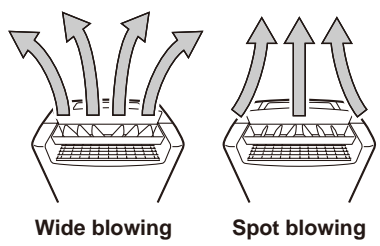

PRODUCT DESCRIPTION

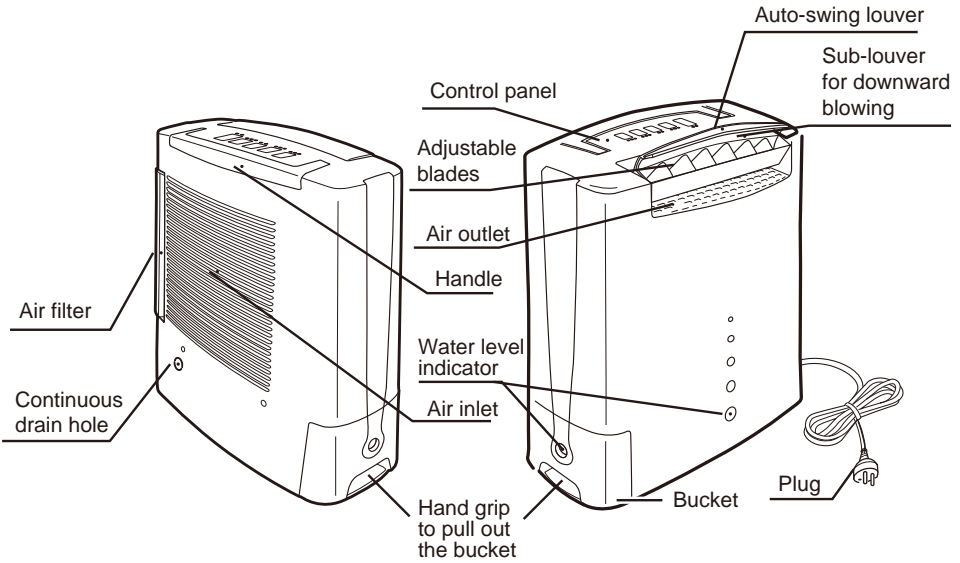

THE CONTROL PANEL

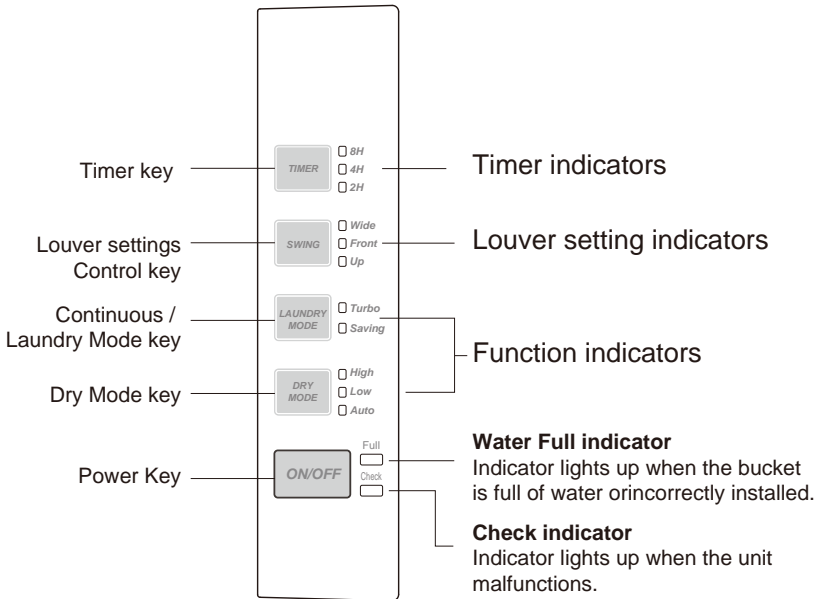

UNIT SETUP

- Place the unit in an upright position on a stable, flat surface.
- Ensure the unit is a safe distance away from a wall or furniture (see the right graphic).
- Keep clothes at a safe distance of 40 cm from air outlet of the unit to prevent water dripping into the unit.

- **Where to position your dehumidifier?**

For best results position the dehumidifier somewhere central, such as the middle of the room or a hallway. Do not position in front of a radiator or in direct sunlight.

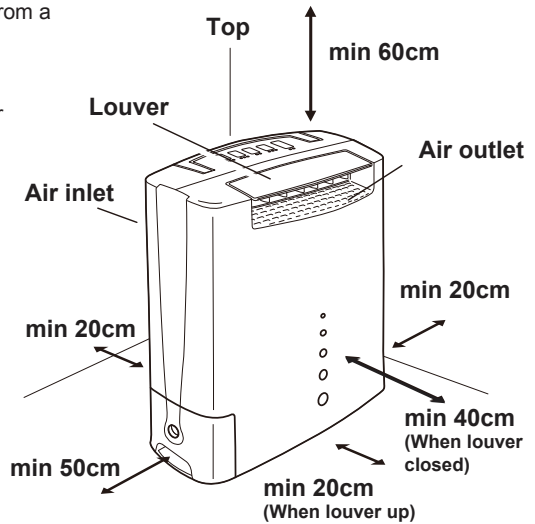

TO OPERATE SAFELY

- Do not insert small objects into the unit as they may cause damage or possible hazard.

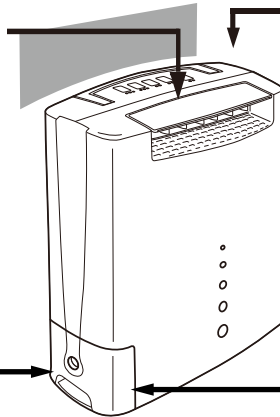

- Keep suitable distance space as above

- Do not remove water bucket when running or water may leak.

- Ensure water bucket is fitted correctly. If the bucket is full or is not in place, the "FULL" lights up and the unit stops.

OPERATING INSTRUCTIONS

ON and OFF

Connect the power plug to the appropriate electrical socket outlet.
Press the ON/OFF button to turn the unit ON.
Press the ON/OFF button again to turn the unit OFF.

Note: In the event of a power failure

Once the power is restored after a power failure, the unit will continue to operate at the selected settings prior to the power failure. This includes the drying mode, swing function and time remaining in timer mode.

Note: After turning the appliance OFF

After turning the unit OFF using the ON/OFF button, the fan will continue to run for a two-minute period. This is a normal procedure and helps to cool & protect the internal components.
During this two-minute period, DO NOT remove the power plug from the power socket outlet; wait for the fan to stop running.

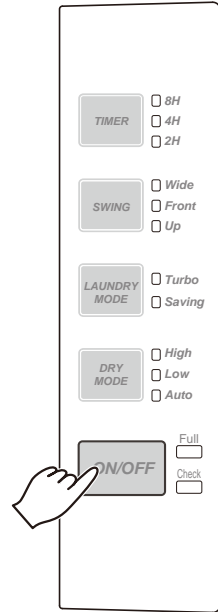

AUTO DRY MODE

- Press the "AUTO DRY" key for dehumidification (general drying of your home or office).



MODE	DESCRIPTION
AUTO	<p>To keep the room at a comfortable relative humidity (RH) level</p> <ul style="list-style-type: none"> • The unit automatically keeps room humidity at 55~60%RH with automatic high or low fan speed.
LOW	<p>To run low fan speed</p> <ul style="list-style-type: none"> • The unit automatically dehumidifies in low fan speed and low heater.
HIGH	<p>Super dry mode to prevent damp, condensation & mould</p> <ul style="list-style-type: none"> • The unit automatically keeps room humidity at 45~50%RH to achieve quicker and efficient drying.

Note: There may be times when the fan speeds are the same for AUTO and LOW.

AUTO itself is not a fan speed but a target relative humidity set point that uses either the low or high fan speeds to reach its target of 55-60%RH.

If the relative humidity of the room is close to or within this range, then switching between LOW and AUTO will make no difference to the fan speed.

OPERATING INSTRUCTIONS

LAUNDRY MODE

- Press the "LAUNDRY MODE" key for drying clothes.

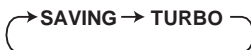



MODE	DESCRIPTION
SAVING	<p>Suitable for warmer temperatures to save power</p> <ul style="list-style-type: none"> The unit automatically provides warm dry air to assist in clothes drying with low power.
TURBO	<p>Suitable in cooler winter temperatures to dry clothes faster</p> <ul style="list-style-type: none"> The unit automatically provides heated air to dry clothes faster with higher power.

AUTO SWING LOUVER

- Press the "SWING" Key to select the preferred air louver angle.



MODE	DESCRIPTION
UP	<ul style="list-style-type: none"> The automatic louver swings in an upward range of approx. 100°. 
FRONT	<ul style="list-style-type: none"> The automatic louver swings in a front range of approx. 50°. 
WIDE	<ul style="list-style-type: none"> The automatic louver swings in a wide range of approx. 150°. 
HOLD	<ul style="list-style-type: none"> The automatic louver stops swinging when you press "SWING" key - turns the LED light off.

The louver modes are useful for speeding up the drying of washing, wardrobes and walls because it directs the airflow towards the surface of these areas - water molecules will be forced out faster.

OPERATING INSTRUCTIONS

WIDE / SPOT ADJUSTABLE LOUVER

Wide blowing

-adjust the blades outwards for an expanded airflow.

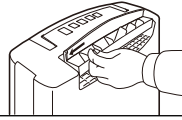

Spot blowing

-adjust the blades inwards for a spot airflow.

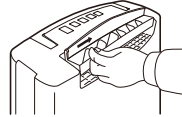

DOWNWARD LOUVER ADJUSTMENT

A sub-louver under the main louver can be moved out for blowing air downward further.

Pull out

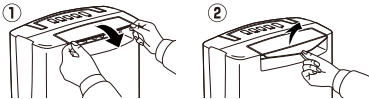

Hold both ends and pull out

Turn central portion upward

Push back

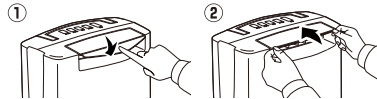

Press central portion downward

Hold both ends and push back

TIMER MODE

- Press the "TIMER MODE" key to select your desired running time (2, 4 or 8 hours). The unit will automatically switch off at the end of the selected time period. As the time counts down the LED (4 or 2 hours) lights will indicate the time remaining.
- When no "TIMER" is set (the LED light is off), the unit will run continuously unless the bucket is already full.

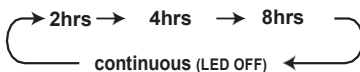

The Timer mode is useful if you want to dry a load of washing in 'Turbo' laundry mode and you know that it will take say, 4 hours and you wish to just run the unit at full power for that time period.

TO EMPTY THE WATER BUCKET

1. When the water bucket is full, the "FULL" LED lights up and the unit stops within a few minutes.
2. Do not move the unit or remove the water bucket if the machine is still operating. Water may leak and cause damage to the unit or cause an electric shock.
3. To remove the water bucket, pull it out by gripping the bottom of the bucket, and lift carefully.
4. Remove the cover of water bucket first, then pour the water away. Clean the bucket and return the cover and the bucket to the correct position.

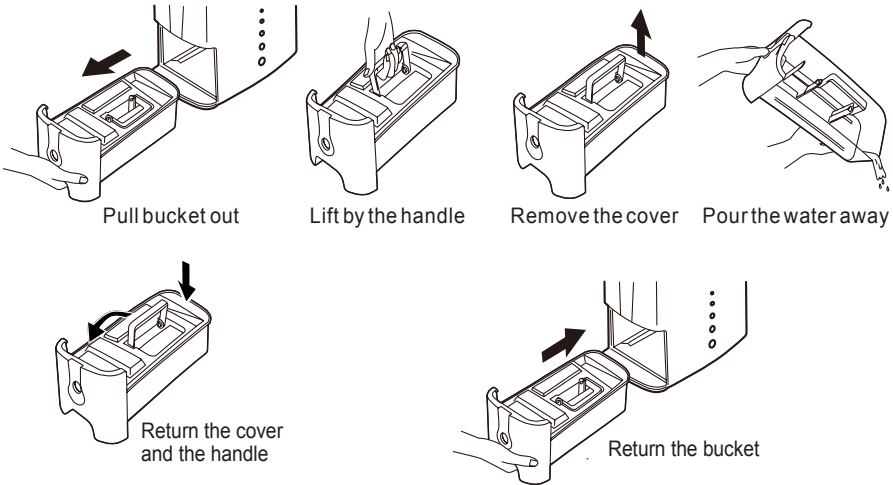

NOTE :

- Clean the water bucket with clean water if needed. Do not use solvents, abrasive materials or hot water.
- Do not remove or damage the float in the bucket, or the unit cannot work correctly.
- The bucket cover must be correctly fitted into position.
- The "FULL" LED lights up if the bucket is not correctly fitted into position.

TO DRAIN WATER

You may use 2 methods to remove the collected water: water bucket or drain hose.

A drain hose with an inner diameter of 12mm is quite suitable for continuous drainage (1.2M drain hose is included):

1. Use a screwdriver to remove the 'knockout' at the back of the unit. Attach the tubing to the connector through the hole.
2. The drain hose should lead downwards away from the unit, with no sharp bends to ensure uninterrupted drainage.

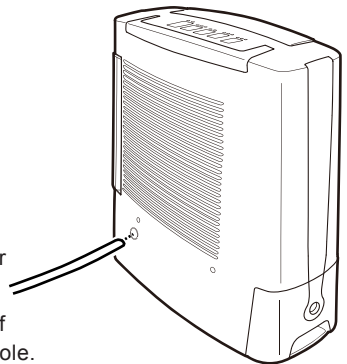

Cleaning the unit

1. Turn off the unit, wait for the fan to stop and unplug from the power socket.
2. Clean the surface with a soft damp cloth.
3. Dry thoroughly with a towel after cleaning.
4. To avoid damage, do not wash or splash the unit with water, or let water drip into the air inlet or air outlet.

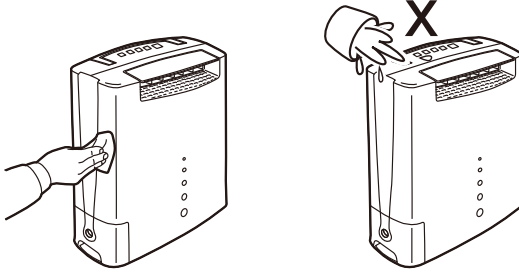

Cleaning the nano-silver air filter

If the nano-silver air filter is covered with dust, the airflow and general performance of the unit may be affected. Check and clean the filter every 2 weeks or as required.

1. Turn off the unit and remove the filter from the unit.
2. Clean the filter with a vacuum cleaner.
3. You may also wash the filter with water and still retain bacterial protection.
4. Replace the filter in position.

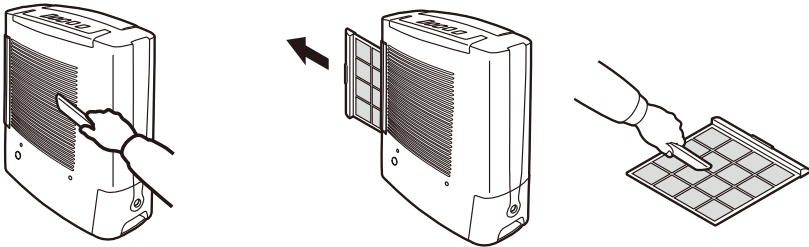

Before placing into storage

1. Turn off the unit, wait for it to stop and unplug from the power socket.
2. Clean and dry the bucket, as well as the filter and the rest of the unit.
3. Ensure the unit is fully drained of water.
4. Cover the unit to prevent it from gathering dust.
5. Store upright in a cool dry place.
6. Do not expose to direct sunlight.

TROUBLE-SHOOTING

Check the following before contacting technical support:

Problem	Cause	Solution
The unit does not operate.	The power is not connected.	Insert power plug into the power socket.
	Power cord or power plug may be damaged.	Inspect power cord and power plug for damage. If damaged, do not use - contact the retailer or distributor for advice.
The device does not dehumidify.	The water container is full.	Empty the water from the container.
	The water bucket has not been replaced correctly.	Return the water bucket into the correct position.
	The air filter is clogged.	Clean the air filter.
	The temperature in the room where the dehumidifier is operating is too low.	The machine does not dehumidify below 1°C. Note: at such low temperatures, the moisture in the room will be very low anyway.
	The relative humidity in the room where the dehumidifier is operating is too low.	The unit dries down to the target relative humidity, then goes into 'fan only' mode until the relative humidity goes above the set point again.
The unit is not drying quickly enough.	The unit may have already reduced the humidity in the room to one of the targets of 55-60%.	Set the DRY MODE to 'High', which may further reduce the humidity to 40-45% Relative Humidity.
The unit works, but reduces the relative humidity insufficiently / there is little water in the water tank.	The room/house is too large. This dehumidifier can dry to about a medium 3 or 4 bedroom house.	We recommend using a dehumidifier with a greater capacity, or 'compressor' dehumidifier.
	There are too many sources of moisture: showers, washing, clothes-drying and cooking all puts moisture into the air. Un-flued gas heating can also add too much moisture into the air for a dehumidifier to remove.	We recommend using a dehumidifier with a greater capacity, or 'compressor' dehumidifier. Consider using a different heat source to an un-flued gas heater.
	The air filter is blocked - the reduced air flow is effecting performance.	Clean the air filter.
Unit is blowing out warm air.	Air is passed over a heating element within the unit, prior to being blown into the room. This is part of the dehumidification process.	This is normal, a dehumidifier is not an air cooler.
The unit is noisy.	The air filter is blocked or the unit is on an uneven surface.	Clean the filter and or put the unit on a flat surface. A dehumidifier will also be noisier on wooden floors than carpet.
The fan still runs after I have turned the unit off.	The fan is cooling the internal heater.	This is normal. The fan will run for about 2 minutes after you press the power button off. Wait for the fan to stop, then turn the unit off at the wall.
The "Check" LED is illuminated.	The unit may not be working properly.	Clean the filter and leave to stand for 20 minutes. Ensure that the dehumidifier is not in front of a hot radiator. If the problem remains, then please contact the distributor.
There is an odour coming from the unit.	The zeolite desiccant material may be returning various household odours back into the room during the dehumidification process.	This odour is not harmful to humans or pets. It will not last long and is not a sign of a fault.

SPECIFICATIONS

Model	AU1000DD
Power supply	AC 220-240V, 50Hz
Power input	Low 410watts / High 720watts
Dehumidifying capacity	10 litres/day (20°C@60%RH)
Recommended room size	50m ² or 125m ³
Capacity water container	3.8 litres
Operating range	1 – 40°C
Dimensions (w x d x h)	W462 x D217 x H525mm
Noise levels	Low 45, High 52 dBA
Power control	Easy soft touch
Desiccant	Zeolite
Drain hose	1.2M provided
Net weight	8.2kgs



For all after-sales enquiries and warranty details please visit our website for contact information, or call 1800 122 100