

Always there to help you

Register your product and get support at
www.philips.com/welcome



AJB4700



User manual

PHILIPS

Contents

1 Important	2
--------------------	----------

2 Your FM/DAB+ clock radio	3
Introduction	3
What's in the box	3

3 Get started	4
Prepare FM/DAB+ antenna	4
Connect power	4
Turn on	4
Set time	4

4 Listen to DAB+ radio	6
For the first time use	6
Store DAB+ radio stations automatically	6
Store DAB+ radio stations manually	6
Listen to a preset DAB+ radio station	6
Use DAB+ menu	7
Show DAB+ information	7

5 Listen to FM radio	8
Tune to FM radio stations	8
Store FM radio stations automatically	8
Store FM radio stations manually	8
Select a preset FM radio station	8
Use FM menu	8
Show RDS information	8

6 Use system menu	10
Set hour format and synchronize time	10
Reset all the settings	10
Know the software version	10

7 Other features	11
Set the alarm timer	11
Set the sleep timer	11
Adjust volume	12
Adjust display brightness	12

8 Product information	13
Amplifier	13
Tuner	13
General information	13

9 Troubleshooting	14
--------------------------	-----------

10 Notice	15
Disposal of your old product	15

1 Important

- Read these instructions.
- Heed all warnings.
- Follow all instructions.
- Do not block any ventilation openings. Install in accordance with the manufacturer's instructions.
- Do not install near any heat sources such as radiators, heat registers, stoves, or other apparatus (including amplifiers) that produce heat.
- Protect the power cord from being walked on or pinched, particularly at plugs, convenience receptacles, and the point where they exit from the unit.
- Only use attachments/accessories specified by the manufacturer.
- Use only power supplies listed in the user manual.
- Unplug this unit during lightning storms or when unused for long periods of time.
- Refer all servicing to qualified service personnel. Servicing is required when the unit has been damaged in any way, such as power-supply cord or plug is damaged, liquid has been spilled or objects have fallen into the unit, the unit has been exposed to rain or moisture, does not operate normally, or has been dropped.
- This unit shall not be exposed to dripping or splashing.
- Do not place any sources of danger on the unit (e.g. liquid filled objects, lighted candles).
- Where the plug of the Direct Plug-in Adapter is used as the disconnect device, the disconnect device shall remain readily operable.



Warning

- Never remove the casing of this clock radio.
- Never lubricate any part of this clock radio.
- Never place this clock radio on other electrical equipment.
- Keep this clock radio away from direct sunlight, naked flames or heat.
- Make sure that you always have easy access to the power cord, plug or adaptor to disconnect the clock radio from the power.

2 Your FM/DAB+ clock radio

Congratulations on your purchase, and welcome to Philips! To fully benefit from the support that Philips offers, register your product at www.philips.com/welcome.

Introduction

With this clock radio, you can

- listen to FM and Digital Audio Broadcasting (DAB+) radio; and
- set two alarms.

What's in the box

(Fig. ①)

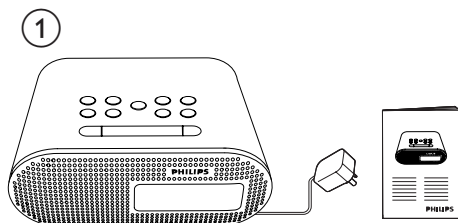

3 Get started

Always follow the instructions in this chapter in sequence.

Prepare FM/DAB+ antenna

For better reception, fully extend and adjust the position of the FM/DAB+ antenna. (Fig. ②)

②

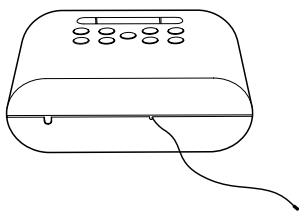

Note

- To prevent interference, position the antenna as far as possible from TV, VCR, or other radiation source.

Connect power

Caution

- Risk of product damage! Make sure that the power supply voltage corresponds to the voltage printed on the back or the underside of the clock radio.
- Risk of electric shock! Hold the plug securely when unplugging the adapter.

Note

- The type plate is located on the bottom of the clock radio.

(Fig. ③)

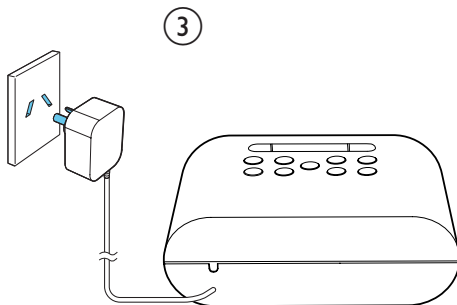

Turn on

Press **POWER**.

- ↳ The clock radio switches to the last selected source.

Switch to standby mode

Press and hold **POWER** for 3 seconds.

- ↳ The clock (if set) appears on the display panel.

Set time

- 1 In standby mode, press and hold **INFO** for 3 seconds to activate the time setting mode. (Fig. ④)
 - ↳ The hour digits blink.
- 2 Press ◀/▶ to adjust the hour.
- 3 Press **INFO** to confirm.
 - ↳ The minute digits blink.
- 4 Repeat steps 2-3 to set the minute.
- 5 Repeat steps 2-3 to set the day, month, and year.

5

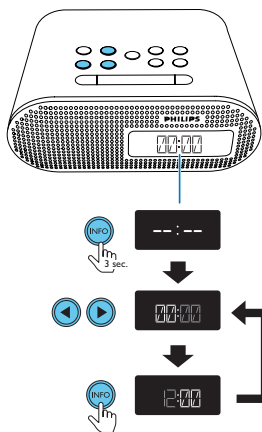

 Tip

- To adjust the 12/24 hour format, see "Use system menu" > "Set hour format and synchronize time".
- When being idle for 10 seconds, the clock radio exits clock setting mode automatically.

4 Listen to DAB+ radio

Digital Audio Broadcasting (DAB+) is a way of broadcasting radio digitally through a network of transmitters. It provides you with more choice, better sound quality and more information.

For the first time use

- 1 Press **SOURCE** repeatedly to select DAB+ radio.
↳ **[FULL SCAN]** (full scan) is displayed.
- 2 Press **SELECT** to start full scan.
↳ The clock radio stores all DAB+ radio stations automatically and then broadcasts the first available station.
↳ The station list is memorized in the clock radio. When you turn on the unit next time, the station scan does not take place.
↳ If no DAB+ station is found, **[No DAB Station]** (no DAB station) is displayed.

To tune to a station from the station list:

In DAB+ mode, press **TUNING** ◀/▶ repeatedly to navigate through the available DAB+ stations.
↳ If the signal of the DAB+ radio station is too weak, **[OFF AIR]** (off air) is displayed.

Store DAB+ radio stations automatically



Tip

- New stations and services will be added in the DAB+ broadcast. To make new DAB+ stations and services available, perform full scan regularly.

In DAB+ mode, press and hold **SCAN** for 3 seconds.

- ↳ The clock radio stores all the available DAB+ radio stations automatically.
- ↳ After full scan, the first available station is broadcast.

Store DAB+ radio stations manually

You can store up to 10 DAB+ radio stations.

- 1 Tune to a DAB+ radio station.
- 2 Press and hold **PRESET** for 3 seconds to activate the storing mode.
- 3 Press **TUNING** ◀/▶ to select a number.
↳ The preset number is displayed for one second. Then if this position is occupied, the previously stored DAB+ station name will be displayed; if this position is empty, **[Empty]** will be displayed.
- 4 Press **PRESET** to confirm.
- 5 Repeat steps 1-4 to store other DAB+ stations.



Note

- To remove a pre-stored DAB+ radio station, store another station in its place.

Listen to a preset DAB+ radio station

In DAB+ mode, press **PRESET** repeatedly to select a preset radio station.

Use DAB+ menu

- 1 In DAB+ mode, press and hold **MENU** for 3 seconds to access DAB+ menu.
- 2 Press **TUNING** ◀/▶ to scroll through the menu options:
 - **[STATION]**: Display a list of available DAB+ stations.
 - **[FULL SCAN]**: Scan and store all available DAB+ radio stations.
 - **[MANUAL]**: Tune to a specific channel/frequency manually and add it to the station list.
 - **[DRC]** (Dynamic Range Control): Add or remove a degree of compensation for differences in the dynamic range among DAB+ stations. You may experiment the options on different source materials to decide which option suits best.
 - **[PRUNE]**: Remove invalid stations from the station list.
 - **[SYSTEM]**: Adjust system settings (see the Chapter "Use system menu").
- 3 To select an option, press **SELECT**.
- 4 Repeat steps 2-3 if sub-option is available under one option.

[DRC]

- **[DRC OFF]**: No compensation applied.
- **[DRC HIGH]**: Maximum compensation applied (the default option recommended for noisy environment).
- **[DRC LOW]**: Medium compensation applied.

[PRUNE]

- **[PRUNE N]**: Return to the previous menu.
- **[PRUNE Y]**: Remove invalid stations from the station list.

Show DAB+ information

While listening to DAB+ radio, press **INFO** repeatedly to scroll through the following information (if available):

- ↳ Station name
- ↳ Dynamic Label Segment (DLS)
- ↳ Signal strength
- ↳ Program type (PTY)
- ↳ Ensemble Name
- ↳ Frequency
- ↳ Signal error rate
- ↳ Bitrate
- ↳ Codec
- ↳ Time and date

5 Listen to FM radio

Tune to FM radio stations

- 1 Press **SOURCE** repeatedly to select FM radio.
- 2 Press and hold **TUNING** ◀/▶ for 3 seconds.
 - ↳ The FM tuner tunes to a station with strong reception automatically.

To tune to a radio station manually:

Press **TUNING** ◀/▶ repeatedly to tune to a radio station.

Store FM radio stations automatically

In FM tuner mode, press and hold **SCAN** for 3 seconds.

- ↳ The clock radio stores all the available FM radio stations automatically.
- ↳ The first stored radio station is broadcast.

Store FM radio stations manually

You can store up to 10 FM radio stations.

- 1 Tune to an FM radio station.
- 2 Press and hold **PRESET** for 3 seconds to activate the storing mode.
- 3 Press **TUNING** ◀/▶ to select a number.
 - ↳ The preset number is displayed for one second. Then if this position is occupied, the previously stored radio frequency will be displayed; if this

position is empty, **[Empty]** will be displayed.

- 4 Press **PRESET** to confirm.
- 5 Repeat steps 1-4 to store more FM stations.



Tip

- To remove a pre-stored FM radio station, store another station in its place.

Select a preset FM radio station

In FM mode, press **PRESET** repeatedly to select a preset radio channel.

Use FM menu

- 1 In FM mode, press and hold **MENU** for 3 seconds to access FM menu.
- 2 Press ◀/▶ to scroll the menu options:
 - **[SCAN SETTINGS]**
 - **[SYSTEM]** (see the Chapter "Use system menu")
- 3 To select an option, press **SELECT**.
- 4 Repeat steps 2-3 if sub-option is available under one option.

[SCAN SETTINGS]

- **[ALL]**: Scan all the available FM radio stations.
- **[STRONG]**: Scan FM radio stations with strong signals only.

Show RDS information

RDS (Radio Data System) is a service that allows FM stations to show additional information.

- 1 Tune to an RDS station.

- 2 Press **INFO** repeatedly to scroll through the following information (if available):
- ↳ Station name
 - ↳ Radio text messages
 - ↳ Program type such as **[NEWS]** (news), **[SPORT]** (sport), **[POP M]** (pop music)...
 - ↳ Frequency
 - ↳ Time and date

WEATH- Weather
ER

RDS program types

Program type	Description	Program type	Description
NEWS	News services	FINANCE	Finance
AF-FAIRS	Politics and current affairs	CHIL-DREN	Children's programs
INFO	Special information programs	SOCIAL	Social affairs
SPORT	Sports	RELIGION	Religion
EDU-CATE	Education and advanced training	PHONE IN	Phone in
DRA-MA	Radio plays and literature	TRAVEL	Travel
CUL-TURE	Culture, religion and society	LEISURE	leisure
SCI-ENCE	Science	JAZZ	Jazz Music
VAR-IED	Entertainment programs	COUN-TRY	Country Music
POP M	Pop music	NATION M	National Music
ROCK M	Rock music	OLDIES	Oldies Music
MOR M	Light music	FOLK M	Folk Music
LIGHT M	Light classical music	DOCU-MENT	Documentary
CLAS-SICS	Classical music	TEST	Alarm Test
OTH-ER M	Special music programs	ALARM	Alarm

6 Use system menu

Use the system menus to

- set 12/24 hour format;
- select whether to synchronize time from the DAB+ stations;
- check the software version of this clock radio; and
- reset the clock radio to factory default status.

Set hour format and synchronize time

- 1 Enter the system menu (see "Listen to DAB+ radio" > "Use DAB+ menu" or "Listen to FM radio" > "Use FM menu")
- 2 Press ◀/▶ to select [TIME].
- 3 Press **SELECT** to confirm.
- 4 Repeat steps 2-3 to select a sub-option.

Options	Sub-option	Function
[UPDATE]	[DAB]	Synchronize time from DAB+ stations.
	[NONE]	Deactivate time synchronization.
[12/24 HR]	[12]	Display time in 12-hour format.
	[24]	Display time in 24-hour format.

Reset all the settings

- 1 Enter the system menu.
- 2 Press ◀/▶ to select [RESET].
- 3 Press **SELECT** to confirm.

- 4 Press ◀/▶ to select an option.
 - [RESET N]: Return to the previous menu.
 - [RESET Y]: Reset the radio to factory default status.
- 5 Press **SELECT** again to confirm.

Know the software version

- 1 Enter the system setting menu.
- 2 Press ◀/▶ to select [SWVER] (Software version).
- 3 Press **SELECT** to confirm.
↳ The software version of the clock radio is displayed.

7 Other features

Set the alarm timer

You can set two alarms to ring at different time. (Fig. 6)

Note

- Make sure that you have set the time correctly.

- 1 Press and hold **AL1** or **AL2** for 3 seconds to activate alarm setting mode.
↳ The alarm icon and the hour digits blink.
- 2 Press ◀/▶ repeatedly to set the hour.
- 3 Press **AL1** or **AL2** to confirm.
↳ The minute digits blink.
- 4 Repeat steps 2-3 to set the minute.
- 5 Repeat steps 2-3 to set the alarm source: DAB, FM or buzzer.
- 6 Repeat steps 2-3 to set the alarm volume.
↳ The alarm icon is displayed.

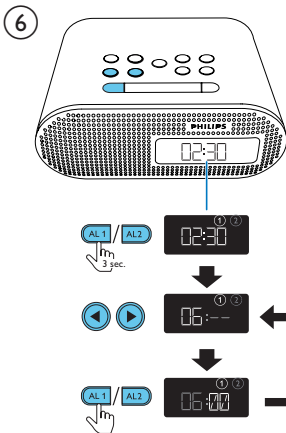

Tip

- When alarms sounds, volume rises gradually.
- If DAB is selected as alarm source, while no DAB+ radio station is available, buzzer is activated when alarm time comes.

Activate/deactivate the alarm timer

- 1 Press **AL1/AL2** to view alarm settings.
- 2 Press **AL1/AL2** repeatedly to activate or deactivate the alarm timer.
↳ The alarm icon appears if the alarm timer is on and disappears if it is off.
 - To stop the ringing alarm, press the corresponding **AL1/AL2**.
↳ The alarm repeats ringing for the next day.

Snooze the alarm

When alarm sounds, press **SNOOZE**.

- ↳ The alarm snoozes and repeats ringing nine minutes later.

Set the sleep timer

This clock radio can switch to standby mode automatically after a preset period.

Press **SLEEP** repeatedly to select the sleep timer period (in minutes).

- ↳ When the sleep timer is activated, **zZ** appears.

To deactivate the sleep timer:

- Press **SLEEP** repeatedly until **[OFF]** (off) appears.

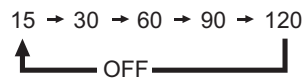

Adjust volume

Press **VOLUME** ▼ / ▲ (Fig. ④)

④

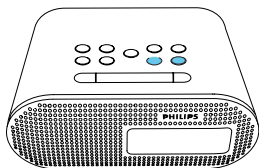

Adjust display brightness

Press **BRIGHTNESS** repeatedly to select different brightness levels.

8 Product information



Note

- Product information is subject to change without prior notice.

Operation Power Consumption	< 3 W
Standby Power Consumption	<1 W
Dimensions - Main Unit (W x H x D)	152 x 62 x 109 mm
Weight - Main Unit	0.3 kg

Amplifier

Rated Output Power	0.5 W RMS
--------------------	-----------

Tuner

FM:

Tuning Range	FM: 87.5 - 108 MHz
Tuning Grid	50 KHz
Sensitivity - Mono, 26dB S/N Ratio	<22 dBf
Search Selectivity	25-32 dBf
Total Harmonic Distortion	< 2%
Signal to Noise Ratio	>50 dBA

DAB:

Tuning Range	174.92-239.20MHz
Total Harmonic Distortion	<2%
Signal to Noise Ratio	>55 dBA

General information

AC Power	(Model)	SSW-1920AU-3 (Philips)
	(Input)	100-240V ~, 50/60 Hz, 0.15 A
	(Output)	6 V == 0.5 A

9 Troubleshooting



Warning

- Never remove the casing of this product.

To keep the warranty valid, never try to repair the product yourself.

If you encounter problems when using this product, check the following points before requesting service. If the problem remains unsolved, go to the Philips Web page (www.philips.com/support). When you contact Philips, make sure that the product is nearby and the model number and serial number are available.

No power

- Make sure that the power adapter is connected properly.
- Make sure that there is power at the AC power outlet.

No sound

- Adjust the volume.

No response from the unit

- Make sure that the unit is connected to power.
- Disconnect and reconnect the AC power plug, then turn the unit on again.

Poor radio reception

- Increase the distance between the unit and your TV or VCR.
- Fully extend the antenna.

10 Notice

Note

- The type plate is located on the bottom of the product.

Any changes or modifications made to this device that are not expressly approved by Philips Consumer Lifestyle may void the user's authority to operate the equipment.

Disposal of your old product

Your product is designed and manufactured with high quality materials and components, which can be recycled and reused.

Never dispose of your product with other household waste. Please inform yourself about the local rules on the separate collection of electrical and electronic products. The correct disposal of these products helps prevent potentially negative consequences on the environment and human health.

Please visit www.recycle.philips.com for additional information on a recycling center in your area.

Environmental information

All unnecessary packaging has been omitted. We have tried to make the packaging easy to separate into three materials: cardboard (box), polystyrene foam (buffer) and polyethylene (bags, protective foam sheet.)

Your system consists of materials which can be recycled and reused if disassembled by a specialized company. Please observe the local regulations regarding the disposal of packaging materials, exhausted batteries and old equipment.



This is CLASS II apparatus with double insulation, and no protective earth provided.

