



eu^o
appliances

cooking

USAGE AND
CARE GUIDE

PRODUCT CODE:

EV900EBSX

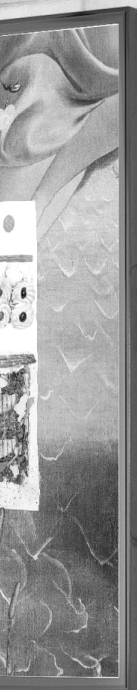

ACKNOWLEDGMENT

Thank you for purchasing our product. We hope you enjoy using the many features and benefits it provides. Before using this product please study this entire Instruction Manual carefully. Keep this manual in a safe place for future reference. Ensure that other people using the product are familiar with these instructions as well.

WARNING

- ↪ When the oven is first switched on, it may give off an unpleasant smell. This is due to the bonding agent used for the insulating panels within the oven. This is completely normal, if it does occur, you merely have wait for the smell to clear before putting food into the oven.
- ↪ The appliance and its accessible parts become hot during use.
- ↪ Care should be taken to avoid touching heating elements.
- ↪ Cleaning and user maintenance shall not be made by children .
- ↪ Do not use harsh abrasive cleaners or sharp metal scrapers to clean the oven door glass since they can scratch the surface, which may result in shattering of the glass.
- ↪ The hob surface is of glass-ceramic: if the surface is cracked, switch off the appliance to avoid the possibility of electric shock.
- ↪ For the models equipped with a facility to use a temperature sensing probe: Only use the temperature probe recommended for this oven.
- ↪ During use, the appliance becomes very hot.
- ↪ Care should be taken to avoid touching heating elements inside the oven.
- ↪ Do not allow children to go near the oven when it is operating, especially when the grill is on.

- ↪ Ensure that the appliance is switched off before replacing the oven lamp to avoid the possibility of electric shock.
 - ↪ The means for disconnection must be incorporated in the fixed wiring in accordance with the wiring specifications.
 - ↪ Children should be supervised to ensure that they do not play with the appliance.
 - ↪ This appliance is not intended for use by persons (including children) with reduced physical, sensory or mental capabilities, or lack of experience and knowledge, unless they have been given supervision or instruction concerning use of the appliance by person responsible for their safety.
 - ↪ Accessible parts may become hot during use. Young children should be kept away.
 - ↪ Never use steam cleaners to clean your cooking range
 - ↪ For models with induction hobs : metallic objects such as knives, forks, spoons and lids should not be placed on the hob surface since they can get hot.
 - ↪ For models with induction hobs : After use, switch off the hob element by its control and do not rely on the pan detector.
 - ↪ For the models with a lid : any spillage should be removed from the lid before opening. The hob surface should be allowed to cool before closing the lid.
- If the supply cord is damaged, it must be replaced by the manufacturer, its service agent or similarly qualified persons in order to avoid a hazard.
 - Danger of fire: Do not store items on the cooking surface.
 - CAUTION: The cooking process has to be supervised. A short term cooking process has to be supervised continuously.
 - WARNING: Unattended cooking on the hob with fat or oil can be dangerous and may result in a fire.
 - This appliance is not intended to be operated by means of an external timer or separate remote-control system.
 - The oven must not be installed behind a decorative door in order to avoid overheating.

**WARNING - AVVERTENZA - ADVERTENCIA - AVERTISSEMENT - WARNUNG - BEMÆRK - WAARSCHUWING
VAROITUSMERKINTÄ - ADVARSEL - UWAGA - ADVERTÊNCIA - AVETIZARE - POZOR - OPOZORILO**

IT	Questo apparecchio non deve essere utilizzato da persone (compresi i bambini) con capacità fisiche, mentali o sensoriali ridotte, o mancanza di esperienza e conoscenza, a meno che non siano sorvegliati o istruiti riguardo l'utilizzo dell'apparecchio da parte di una persona responsabile della loro sicurezza. E' necessario sorvegliare i bambini affinché non giochino con l'apparecchio.
FR	Cet appareil ne doit pas être utilisé par des personnes (y compris les petits enfants) avec capacités physiques, mentales ou sensorielles réduites, ou absence d'expérience ou connaissance, à moins qu'ils ne soient surveillés ou instruits sur l'utilisation de l'appareil par une personne responsable de leur sécurité. Il est nécessaire de surveiller les petits enfants pour s'assurer qu'ils ne jouent pas avec l'appareil.
EN	The appliance must not be used by people (including children) with limited physical, sensory or mental abilities, or without experience or expertise, unless they have received instructions for using it from those responsible for their safety. Young children should be supervised to ensure they not play with the appliance.
DE	Das Gerät darf von Personen (einschließlich Kindern), deren physische, sensorische oder geistige Fähigkeiten und deren Mangel an Erfahrung und Kenntnissen einen sicheren Gebrauch des Gerätes ausschließen nur unter Aufsicht oder nach ausreichender Einweisung durch eine verantwortungsbewußte Person benutzt werden, die sicherstellt, dass sie sich der Gefahren des Gebrauchs bewusst sind. Achten Sie darauf, dass Kinder nicht mit dem Gerät spielen können.
DK	Apparatet er ikke beregnet til at blive brugt af børn eller personer med fysiske, sensoriske eller mentale handicap eller med manglende erfaring og viden, medmindre disse personer er under opsyn eller er oplært i brugen af apparatet af en person, der er ansvarlig for deres sikkerhed. Lad ikke børn lege med apparatet.
ES	El aparato no ha sido diseñado para que lo utilicen personas (incluidos niños) con reducidas capacidades físicas, sensoriales o mentales, o personas sin experiencia ni conocimientos adecuados, a menos que quienes estén encargados de su seguridad las hayan instruido sobre cómo usar el aparato y las vigilen en todo momento. Evite que los niños jueguen con el aparato.
FI	Laitteen ei ole tarkoitettu sellaisten henkilöiden käyttöön (lapset mukaan lukien), joiden fyysisen, aistien tai mielen terveys on heikentynyt tai joilla ei ole laitteen käyttämistä varten tarpeellista kokemusta tai tietoa, ellei heidän turvallisuudestaan vastaava henkilö ole valmentanut heitä laitteen käyttöä varten tai valvo sitä. Valvo, että pikkulapset eivät pääse leikkimään laitteella.
GR	Η συσκευή αυτή δεν προορίζεται για χρήση από άτομα (συμπεριλαμβανομένων των παιδιών) με μειωμένες σωματικές, αισθητήριες ή πνευματικές ικανότητες ή έλλειψη εμπειρίας και γνώσης, εκτός και εάν εξαρχής επιβλέπονται ή έχουν λάβει οδηγίες σχετικά με τη χρήση της συσκευής από άτομο υπεύθυνο για την ασφάλειά τους. Τα μικρά παιδιά πρέπει να επιβλέπονται για να εξασφαλιστεί ότι δεν παίζουν με τη συσκευή.
NL	Het apparaat mag niet worden gebruikt door personen (inclusief kinderen) met lichamelijke, sensorische of geestelijke beperkingen of personen zonder ervaring of kennis, tenzij zij over het gebruik van het apparaat zijn voorgelicht door personen die verantwoordelijk zijn voor hun veiligheid. Jonge kinderen moeten onder toezicht worden gehouden om ervoor te zorgen dat ze niet spelen met het apparaat.
NO	Denne apparatet er ikke beregnet for å bli betjent av personer (gjelder også barn) med redusert fysiske, åndelige eller mentale evner eller som ikke har erfaring i eller kunnskaper om bruken, dersom de ikke har fått grunnleggende veiledning eller opplæring angående bruken av en person som er ansvarlig for deres sikkerhet. Pass på at barn ikke leker med apparatet.
PL	Niniejsze urządzenie nie jest przeznaczone do użytku przez osoby (w tym dzieci) o ograniczonych zdolnościach ruchowych, postrzegania lub umysłowych, a także osoby nie posiadające odpowiedniej wiedzy i doświadczenia, chyba że osoba odpowiedzialna za ich bezpieczeństwo udzieliła odpowiedniego instruktażu z zakresu obsługi urządzenia i nadzorowała pierwsze czynności obsługi. Kontrolować, czy dzieci nie bawią się urządzeniem.
PT	A utilização do aparelho não é permitida a pessoas (incluindo crianças) com capacidades físicas, sensoriais ou mentais reduzidas, ou com falta de experiência ou conhecimentos, a menos que tenham recebido instruções relativas ao uso do aparelho por parte de pessoas responsáveis pela sua segurança. Esteja atento às crianças pequenas e certifique-se de que não brincam com o aparelho.
SE	Apparaten får ej användas av personer (inklusive barn) med reducerad fysisk, känslomässig eller mental kapacitet, eller av personer utan lämplig kompetens eller erfarenhet, såvida de inte fått instruktioner om apparatens användande från den eller de personer som ansvarar för deras säkerhet. Se till att barn inte leker med apparaten.

RO	Acest aparat nu trebuie utilizat de persoane (inclusiv copii) cu capacități fizice, senzoriale sau mentale reduse, sau lipsite de experiență și cunoștințe, decât dacă au primit instrucțiuni cu privire la utilizarea aparatului de la o persoană responsabilă de siguranța acestora. Copiii nu trebuie să se joace cu aparatul.
RU	Не разрешается использование данного прибора лицами (включая детей) со сниженными физическими, сенсорными или умственными возможностями, а также лицами, не имеющими соответствующего опыта и знаний, без надзора или предварительного обучения пользованию оборудованием со стороны лица, отвечающего за их безопасность. Не допускайте никаких игр детей с прибором.
UK	Люди (у тому числі діти) з обмеженими фізичними, сенсорними та психічними можливостями або які не мають відповідного досвіду чи знань не повинні користуватися цим приладом, хіба що вони отримують інструкції щодо користування ним від тих, хто відповідає за їхню безпеку. Необхідно наглядати за малими дітьми, щоб вони не гралися з цим приладом.
IS	Ekkí er ætlast til að fólk með skerta líkamlega eða andlega getu eða skynjun (að börnum með töldum) noti þennan búnað. Það á líka við um fólk sem ekkí býr yfir nauðsynlegri reynslu eða þekkingu, nema það njóti umsjónar eða aðstoðar einhvers sem ber ábyrgð á öryggi þess, á meðan tækiló er í notkun. Börn þurfa að vera undir eftirliti svo trygg sé að þau leiki sér ekkí með tækiló.
SI	Naprave ne smejo uporabljati ljudje (tudi otroci) z zmanjšanimi fizičnimi sposobnostmi, psihi čnimi ali zaznavnimi sposobnostmi ali brez potrebnih izkušenj ali znanja, razen če jih pri uporabi naprave ne nadzira in vodi oseba, odgovorna za njihovo varnost. Pazite, da se otroci ne bi igrali z napravo.
HR	Ovaj ure đaj ne smiju koristiti osobe (uključujući djecu) slabijih fizičkih, mentalnih ili osjetilnih mogućnosti, niti osobe koje ne posjeduju odgovarajuće iskustvo i znanje, osim ako ih druga osoba odgovorna za sigurnost ne nadgleda ili ne navodi pri korištenju. Djeca se moraju nadgledati kako se ne bi igrala s uređajem.
HU	Ezt a készüléket nem használhatják korlátozott fizikai, mentális, illetve érzékelési képességekkel rendelkező (beleértve a gyerekeket), vagy a szűkséges tapasztalattal, illetve szaktudással nem rendelkező személyek, kivéve, ha a biztonságukért felelő személy a készülék használatával kapcsolatban felügyeli, vagy képződket. A gyermekekre felügyelni kell, nehogy játszanak a készülékkel.
CS	Toto za řízení nesmí obsluhovat lidé (ani děti) s nedostatečnou fyzickou, psychickou nebo senzorickou způsobilostí nebo osoby bez potřebných zkušeností a znalostí, pokud nejsou pod dohledem nebo pokud nejsou řádně poučeni o používání tohoto zařízení osobou zodpovědnou za jejich bezpečnost. Děti musí být vždy pod dohledem, aby si se zařízením nemohli hrát.
SK	Toto zariadenie nemôžu používať ľudia (vrátane detí) s obmedzenými fyzickými, psychickými alebo zmyslovými schopnosťami, prípadne bez potrebných skúseností a znalostí, pokiaľ na ne nedohliada alebo ich nepoučí o používaní zariadenia osoba, ktorá je zodpovedná za ich bezpečnosť. Na deti musíte dohliadať, aby sa zaistilo, že sa zo zariadením nebudú hrať.
TR	Bu aparat fiziksel, duyumsal ve zihinsel kapasiteleri yetersiz kişiler tarafından (çocuklar dahil) veya bu kişiler, onların güvenliğinden sorumlu bir kişi tarafından aparatın kullanımı esasında denetlenmedikleri ve kullanımı hakkında bilgilendirilmemiş olduklarında veya deneyim ve bilgi eksikliğinde kullanılmamalıdır. Çocukların aparat ile oynamadıklarını kontrol altında tutmak gerekir.
BG	Този уред не трябва да бъде използван от лица (включително деца) с понижени физически, умствени или сетивни възможности, както и от лица без необходимия опит и познания, освен в случаите, когато същите са направлявани или инструктирани относно употребата и работата с уреда от лице, отговорно за безопасността. Не трябва да се разрешава на деца да играят с уреда.
AR	هذا الجهاز غير مصمم للاستخدام بواسطة الأشخاص (بما في ذلك الأطفال) ذوي الإمكانات البدنية أو الحسية أو العقلية المحدودة، أو الأشخاص محدودي الخبرة أو الدراية، إلا بعد تزويدهم بالتدريب والإشراف اللازم فيما يتعلق باستخدام الجهاز بواسطة شخص مسنون عن سلامتهم. يجب الإشراف على الأطفال لضمان عدم لعبهم بالجهاز.

Installation instructions

Safety precautions	7
Before installing	7
Appliance	7
Installation	10
Fitting the adjustable feet	10
Fitting the splash guard	11
Positioning and levelling	11
Electrical connection	12
Stability brackets	14

Safety precautions

This manual is valid for several models.
Variations in details for each cooker are possible.

The safe operation of this appliance can only be guaranteed if it has been professionally assembled and installed in accordance with these instructions. The individual who assembled and installed the appliance is liable for damage or faults resulting from incorrect assembly or installation.

All installation and adjustment work, must be undertaken by an authorized expert and carried out in accordance with the currently applicable rules and regulations of the local electricity supply company.

Shut off the supply of electricity before carrying out any work.

Electrical appliances must always be earthed.

If an extractor hood is to be fitted, it must be fitted according to the associated assembly instructions. Ensure that the hood is fitted at least 650 mm clear of the hob.

Before installing

Appliance

Unpacking

Check the condition of the appliance after unpacking it. Do not connect the appliance if it has been damaged in transport.

Dispose of packaging in an environmentally-friendly manner.

Appliance dimensions

A=89-149 mm

Note the specified dimensions.

All product outward appearance, the color take the material object as, the picture only supply the reference.

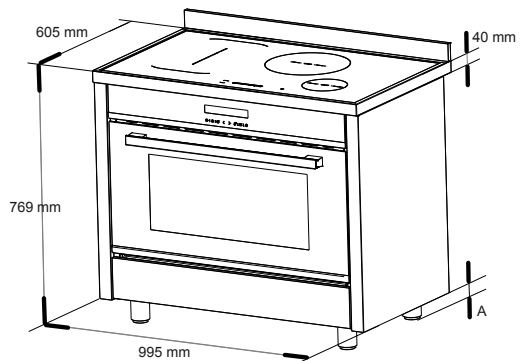
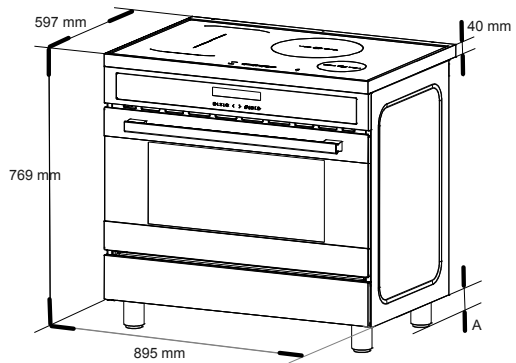
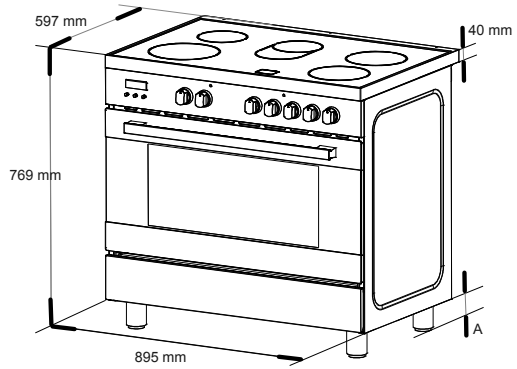

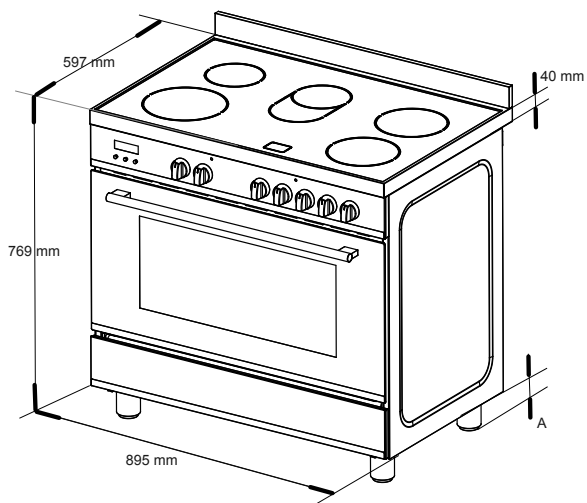

Adjacent units

Adjacent units must be made of non-combustible material. The fronts of adjacent units must be resistant to temperatures up to at least 90 °C. If the appliance is fitted close to other units, the minimum distances specified in the picture must be maintained.

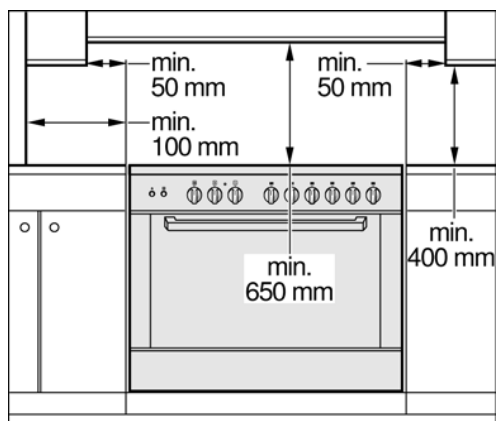

Installation

This appliance is always supplied with a set of adjustable feet and, depending on the model, with a splash guard.
The appliance may also be used without the splash guard.

Fitting the adjustable feet

Beforehand:

- ☑ Remove all parts that are not permanently fixed.
- ☑ Remove the accessories from the oven.

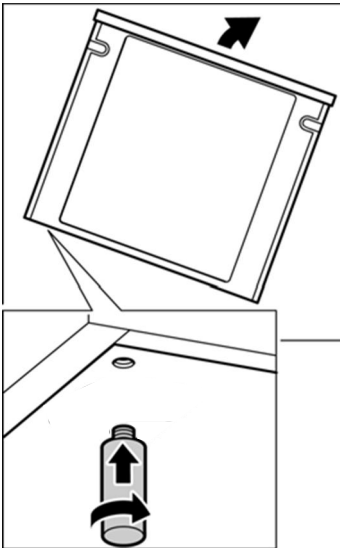

Proceed as follows:

- ☑ Tilt the appliance by raising one side slightly from the floor.
- ☑ With the plates in position, screw the adjustable feet into the mounting holes on the underneath of the appliance.
- ☑ Repeat the process on the other side.

You can make the final adjustments to the feet in order to level the appliance once the electricity supply has been connected.

If it is necessary to pull the appliance, screw the adjustable feet in fully. Make the final settings only when the other installation tasks have been completed.

Fitting the splash guard

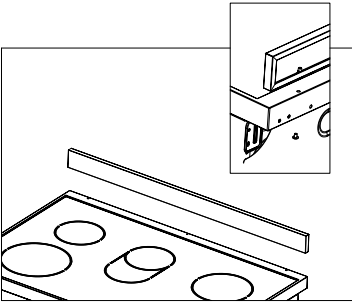

Depending on the model.
Proceed as follows:

- Remove the packaging and the protective film from the splash guard.
- Screw the splash guard onto the rear of the appliance using the 2 bolts.
- Not permitted use with lids or covers aftermarket.

WARNING: This appliance is not suitable to be installed on a base

Positioning and levelling

Positioning the appliance

When installing the appliance, make sure that there is enough space in the final installation location to pull the appliance forwards for cleaning and maintenance work.

The ground underneath must be hard and stable. The wall immediately behind the appliance must be made from non-flammable material, e.g. tiles.

If you need to pull the appliance in order to position it, make sure that the adjustable feet are screwed in fully.

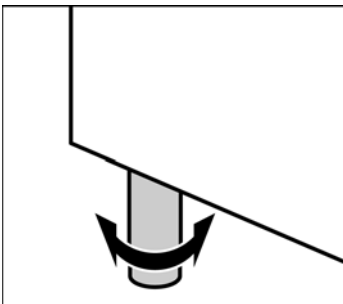

Levelling the appliance

Level the appliance once all other work has been completed.

To do this, turn the adjustable feet.

Electrical connection

⚠ This appliance must be earthed by law. Before connecting the appliance to the electrical supply, check that the earth system in your house is working correctly.

⚠ Check that unit voltage and power, marked on the rating plate applied on the appliance, are correct for the supply. It is necessary that the feeding network is protected by a powerful switch able to disconnect completely the network with a contacts separation of at least 3 mm. Be sure that the earth wire green/yellow is not interrupted by the switch.

WARNING: THIS APPLIANCE MUST BE EARTHED

⚠ In order to avoid hazard, any electrical work performed on this equipment or its associated wiring should only be done by persons authorised by the manufacture or similiary qualified persons.

Replacement or mounting of the power cord

The mains cable is replaced via the rear backboard.

The mains cable must be of the following type:

380-415V 3N~

220-240V

H05RR-F

H05RR-F

H05VV-F 5×2.5mm²

H05VV-F 3×4mm²

H05RN-F

H05RN-F

H07RN-F

H07RN-F

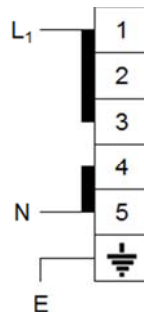
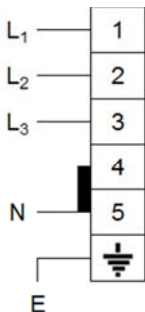

Leave the mains cable slightly overlong so that you can pull out the appliance for cleaning purposes.

Proceed as follows:

➤ Remove the rear backboard.

➤ Undo the screw on the terminal block that fixes the cable in place.

➤ Loosen the screw contacts and replace the cable with a new one of the same length.

The cable must comply with the stipulated specifications.

➤ Connect the yellow-green wire to the  terminal. This wire must be at least 10 mm longer than the other wires.

➤ Connect the blue neutral wire to terminal N.

➤ Connect the brown power wire to terminal L.

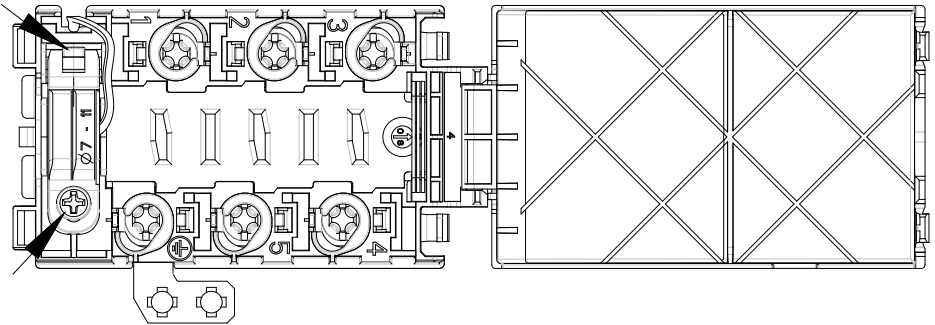

Stability bracket

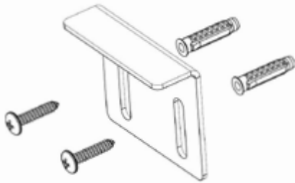
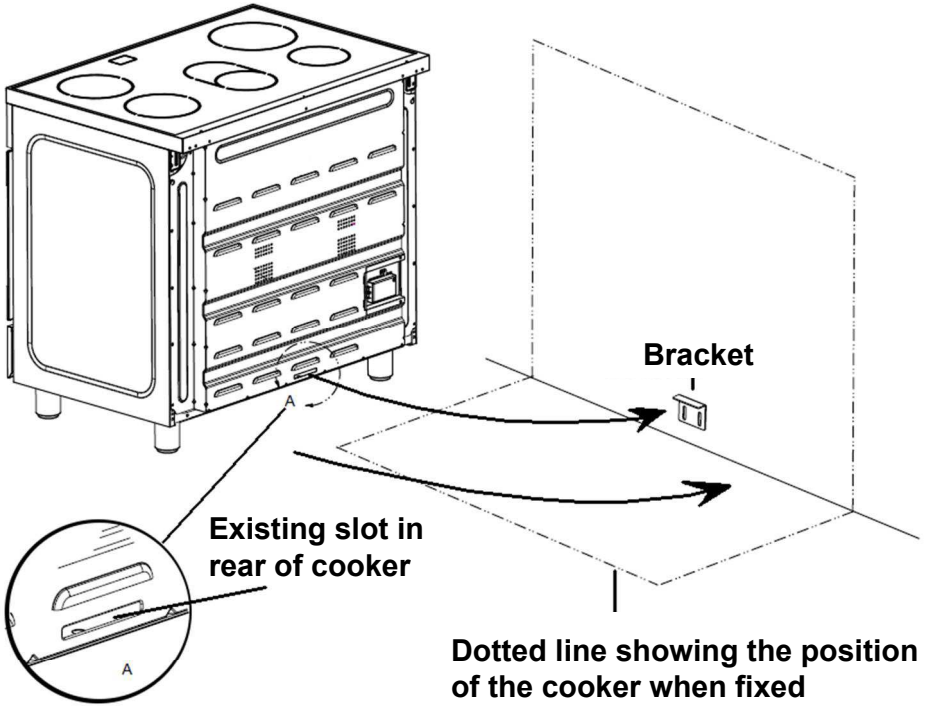

Wall fixing

Instructions for use

この 16 ページの図、表、写真、イラスト、および、を参照してください。

Safety precautions	17
Property damage	19
Your new appliance	20
The control panel	20
The ceramic hob	21
The oven	40
Using progammer at cooking	47
The storage compartment.....	50
Before using for the first time	51
Baking out the oven	51
Using the rotary spit	53
Cleaning and care	56
Catalytic cooking compartment panels	56
Telescopic rails	57
Using the correct cleaning agent	58
Cleaning the interior glass of the oven	59
Removing and fitting the appliance door	61
Removing and inserting the hook-in racks	63
Faults and the after-sales service	64
Replacing the oven light bulb	65
Aftersales service	66
Tips and tricks	67
Tips for saving energy	67
Tips on using the ceramic hob	67
Tips on using the oven	67
Tips for using your appliance	68
Boiling and frying	68
Baking tips	69
Tips on using the rotary spit	69

Important information

Read the instructions for use carefully.
This will enable you to operate your appliance safely and correctly.

This manual is valid for several models.
Variations in details for each cooker are possible.

Please keep the instruction manual, installation instructions and the various accessories in a safe place. Please pass on these manuals and accessories to the new owner if you sell the appliance.

Transport damage

Check the appliance for damage after unpacking it. Do not connect the appliance if it has been damaged in transport.

Environmentally-friendly disposal

Dispose of packaging in an environmentally-friendly manner.



This appliance is labelled in accordance with European Directive 2012/19/EU on Waste Electrical and Electronic Equipment WEEE.

Connections

Have a licensed professional carry out the electric connection .
Assembly instructions are supplied with the appliance.

Any damage caused by the appliance being incorrectly connected is not covered under the guarantee. We assume no liability for damage and faults caused by connection and setting errors.

Safety precautions

This appliance is intended for domestic use only.
This appliance must only be used for food preparation.

Adults and children must not operate the appliance without supervision if:

- ☐ they do not have the physical or mental ability;
- ☐ or they lack the knowledge and experience required to operate the appliance safely and correctly.

Never let children play with the appliance.

Never drag, push or move the device once unpacked. The appliance should be lifted and placed in the position desired in order to prevent accidental damage to the floor.

Open the cover plate when the oven is working. Do not use harsh abrasive cleaners or sharp metal scrapers to clean the oven door glass since they can scratch the surface, which may result in shattering of the glass.

Do not use steam cleaners to clean the appliance.

Hot surfaces

Risk of burns.

Never touch the hob plates, the surfaces of the cooking compartment, the heating elements or the oven steam outlets when they are hot.

Children must be kept at a safe distance from the appliance at all times.

Open the appliance door carefully. Hot steam may escape.

If the hob plates are in operation for a prolonged period, the areas between them can become hot.

Risk of fire.

Never leave flammable objects on the hob or in the storage compartment, or keep them in the cooking compartment.

Risk of short-circuit.

Never trap the mains cable of electrical appliances in the appliance door when it is hot or pull the cable over the hob plates when they are hot. The cable insulation may melt.

Overheated oil and fat

Risk of fire.

Overheated oil or fat can ignite very quickly. Never leave fat or oil to heat unattended. Should the oil ignite, do not try to put it out by pouring water on it. Cover the pan immediately with a lid or plate. Switch off the hob plate. Allow the cookware to cool down on the hob plate.

High-proof alcohol

Be careful with food that is prepared using drinks with a high alcohol content (e.g. cognac, rum). Alcohol evaporates at high temperatures. In unfavourable circumstances, the alcoholic vapours could catch fire in the appliance.

Risk of burns.

Only use small quantities of drinks with a high alcohol content and open the appliance door carefully.

Repairs

Risk of electrocution.

Incorrect repairs are dangerous.

Repairs may only be carried out by one of our experienced after-sales engineers.

Risk of electrocution.

Never replace a damaged power cable yourself.

Power cables may only be replaced by one of our experienced after-sales engineers.

Switch off the circuit breaker in the fuse box if the appliance is faulty.

Lateral stress

Possibility of tilting



In order to prevent tipping of the appliance. This stabilising means must be installed. Refer to the installation



Anti-tip restraint

This appliance is labelled in accordance with European Directive 2011-05(IEC)

Property damage

Damage to the hob

Only use the hob plates if cookware is placed on them.

Do not heat empty pots or pans.

This will damage the pan base.

Do not allow saucepans to boil dry, in particular enamel and aluminium saucepans.

The pan base must be clean, dry and flat.

With electric hotplates, it is possible that not enough heat is drawn off and the pans become red hot.

Please follow the manufacturer's instructions when using special cookware. Aluminium foil and plastic containers can melt and stick on hot burners.

Do not use a roasting dish which has to be heated using two burners. This will cause heat to accumulate. This could damage the appliance.

Please note that appliances with a hob cover may only be used with the hob cover open.

Damage to the oven

Never cook meals on the floor of the cooking compartment. Do not leave the baking tray on the cooking compartment floor. Do not cover it with aluminium foil. Do not place oven or cookware on the oven floor. This will cause heat accumulation. The baking and roasting times will no longer be correct and the enamel will be damaged.

Never pour water directly into a hot oven. This will damage the enamel. When making very moist fruit flans, do not put too much on the baking tray. Fruit juice dripping from the baking tray leaves stains that cannot be removed.

Do not stand or sit on the open oven door.

Damage to the fronts of adjacent units

Only leave the oven to cool down with the door closed. The fronts of adjacent units may eventually become damaged even if you only leave the oven door open slightly.

If the oven door seal is very dirty, the appliance door will no longer close properly during operation. The fronts of adjacent units will become damaged over time. Keep the seal clean.

Your new appliance

Get to know your appliance. You will find information about the control panel and hob, as well as the oven, types of heating and accessories.

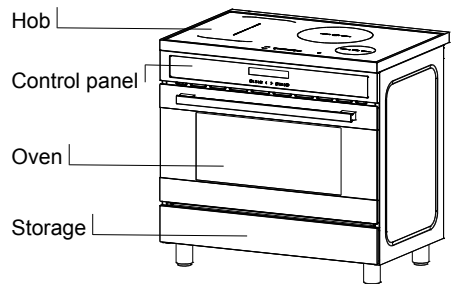
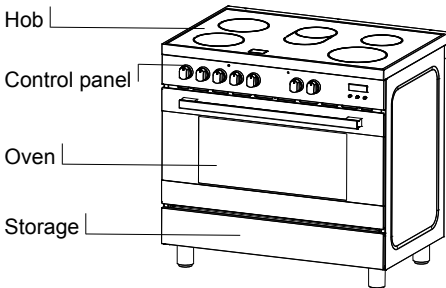

The hob (according to the models)

Induction hob

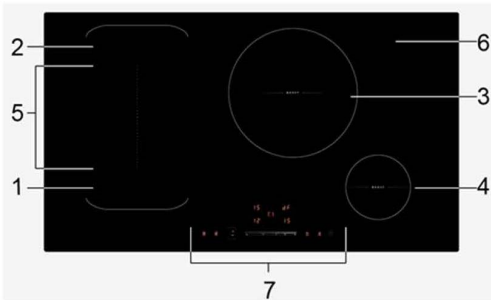

1. max. 1800/3000 W zone
2. max. 1800/3000 W zone
3. max. 3000/4000 W zone
4. max. 1400/2000 W zone
5. Flexible zone 3000/4000 W
6. Glass plate
7. Control panel

Table for domestic electric hob in according to the Delegated Regulation (UE) n° 66/2014 Energy Consumption calculated according to standard EN 60350-2: 2013

Identification Model	See rating plate		
Type hob	Cooktop		
Number of zones or areas of cooking		5	
Type of heating system		Induction plate	
Cooking circular zones	3 =	28,0	cm
	4 =	15,0	cm
Cooking not circular zones	1 L	20,0	cm
	W	23,0	cm
	2 L	20,0	cm
	W	23,0	cm
	5 L	40,0	cm
	W	23,0	cm
Energy consumption per area	EC electric cooking	1 = 210,4 2 = 210,4 3 = 199,7 4 = 189,8 5 = 211,7	Wh/kg Wh/kg Wh/kg Wh/kg Wh/kg
Energy consumption of the hob	EC electric hob	204,4	Wh/kg

HOB TOTAL 7.4KW
OVEN TOTAL 2.94KW
Maximum Power 10.34KW

Voltage
220-240V ~50Hz-60Hz
380- 415V 3N ~50Hz-60Hz

Ceramic hob

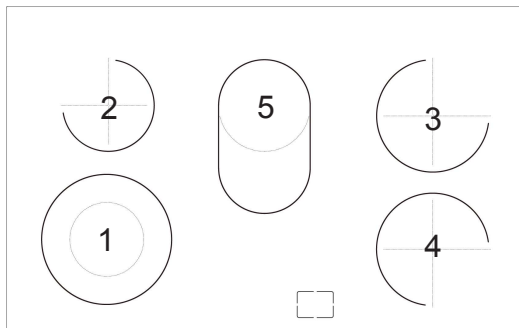

1. 1000/2200W
2. 1200W
3. 1800W
4. 1800W
5. 1100/2000W

Table for domestic electric hob in according to the Delegated Regulation (UE) n° 66/2014 Energy Consumption calculated according to standard EN 60350-2: 2013

Identification Model	See rating plate		
Type hob	Cooktop		
Number of zones or areas of cooking		5	
Type of heating system		Radiating plate	
Cooking circular zones	1 = ϕ 2 = ϕ 3 = ϕ 4 = ϕ	22,0 15,5 19,0 19,0	cm cm cm cm
Cooking not circular zones	5 L W	26,0 15,5	cm cm
Energy consumption per area	EC electric cooking	1 = 190,5 2 = 218,0 3 = 203,0 4 = 201,4 5 = 220,4	Wh/kg Wh/kg Wh/kg Wh/kg Wh/kg
Energy consumption of the hob	EC electric hob	206,6	Wh/kg

HOB TOTAL 9.0KW
OVEN TOTAL 2.94KW
Maximum Power 11.94KW

Voltage
220-240V ~50Hz-60Hz
380-415V 3N ~50Hz-60Hz

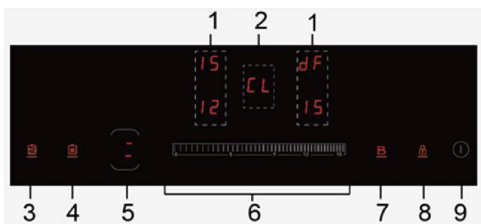

1. Heating zone selection controls
2. Timer control
3. Boiling cue control
4. Keep warm control
5. Flexible zone control
6. Power / Timer slider touch control
7. Boost control
8. Keylock control
9. ON/OFF control

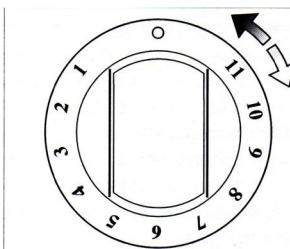
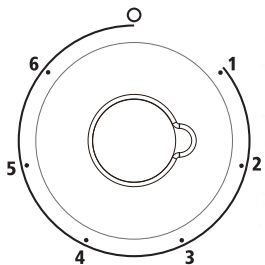

Hob controls

(according to the models)

Control knobs

INSTRUCTIONS FOR USE OF THE ELECTRIC HOB AND CERAMIC WORK-TOP

CERAMIC WORK-TOP

The work-top is fitted with cooking areas of different diameter and power.

The positions are clearly marked. The heating occurs only within the diameters marked on the work-top. For efficient cooking and energy saving, it's essential to use only suitable saucepans.

Cookware with rough bottoms should not be used since these can scratch the ceramic surface. Before use, make sure that pan bottoms are clean and dry.

Pans should have the same diameter as the cooking zone they are used on.

When cold, pan bottoms should be slightly concave, as they expand when they are hot and lie flat on the surface of the hob. This transfers the heat best.

The best thickness for pan bottoms is 2-3mm in case of enamelled steel and 4-6mm for stainless steel with sandwich type bottoms.

There is a simple way of checking whether the pan bottom is of the right shape (when cold).

Rest the middle of the bottom at an angle against the straight edge of a table and slip a few strips of typing paper between them.

As a guide five to ten pieces of paper is correct for enamelled steel pans and two to five strips for stainless steel (the higher number applies to the larger sizes of pan).

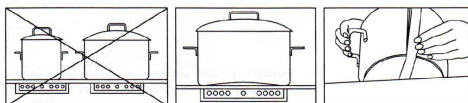

These rules are very important. If they are not followed there will be a great loss of heat and energy, and the heat not absorbed by the saucepan will spread to the hob, frame and surrounding cabinet.

Using the cooking hob

The first few times the hob is used, it may give off acrid, burning smells.

These will disappear completely with repeated use.

Each cooking area has a selector knob on the appliance control panel for setting different temperature levels.

For normal cooking, place the saucepan on the desired area of the hob and set the knob to the maximum heat.

A warning light on the control panel will inform you if the cooking area is on or off.

Some of the cooking work-tops have an indicator light between the two front cooking areas, which lights up when one or more of the cooking areas goes above the temperature of 60°C.

The indicator light switches off only when the temperature of the cooking areas goes below about 60°C.

After a few minutes, when the contents of the saucepan are boiling, turn the knob to a lower position, depending on the quantity, so that the saucepan does not splash over and there is no waste of heat.

Important

Be very careful about the safety of children when using the ceramic hob.

Attention

Although the hob surface is very tough, it is certainly not unbreakable and it can be damaged, especially if pointed or hard objects fall on it with a certain force.

Do not use the hob if the surface is broken or cracked; contact the assistance service immediately.

USING ELECTRIC HOTPLATES

When using an electric hotplate for the first time or after a long period of disuse, turn the knob to 1 and let it heat for about 20 minutes to eliminate any possible moisture absorbed by the internal insulating material.

-Dry the bottom of the pan before placing it on the hotplate.

-Turn the hotplate on only after placing the pan on it.

The hotplate is controlled by a commutator. Turn the knob until position 1 to turn the hotplate on (Fig.1).

A warning light on the control panel will inform you if the plate is on or off.

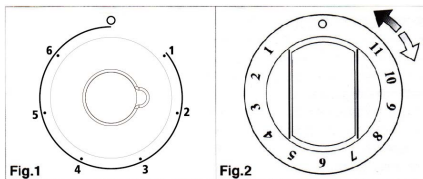

USE OF PLATES WITH TWIN-CIRCUIT ENERGY REGULATOR

The plate is controlled by an energy regulator.

1) To activate the first circuit, rotate the knob from 1 to 11.

2) To activate the second circuit, rotate the knob past the number 11 (Fig.2).

To return to single-circuit operation, reset the knob to zero then to the number required.

GUIDELINE TABLE

The actual settings depend on the quantity and quality of the food and the type of saucepan.

Pos.	Heat Intensity	Use
0	0	Off
1 - 2	1	Very slow For melting butter, chocolate, etc. For heating small amounts of liquid.
3 - 4	2	Low For heating larger amounts of liquid. For preparing slow-cooking creams and sauces.
5 - 6	3	Medium-Low For thawing frozen foods and cooking steaks, cooking at boiling or lower temperatures.
7 - 8	4	Medium For boiling foods, roasting delicate meats and fish.
9 - 10	5	High For braising chops and steaks, for large meat soups.
11	6	Very High For boiling large amounts of water and frying.

GLASS-CERAMIC SURFACE

To clean the work-top, you must follow the same precautions you use to clean the glasses of your house. Soft stains caused by aluminium pans bottoms can be removed by means of vinegar.

Make sure that sugar does not fall on the work-top during cooking, if it falls disconnect the relevant hotplate, and clean as soon as possible with hot water, before it gets cold.

In case there are stains of burnt sugar or similars after cooking, clean them using a spatula or a razor before the cooking zone becomes cold (see picture).

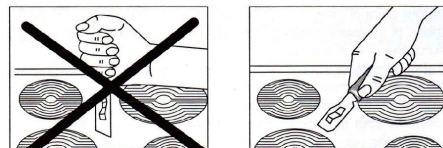

Instruction for use of the induction hob

A Word on Induction Cooking

Induction cooking is a safe, advanced, efficient, and economical cooking technology. It works by electromagnetic vibrations generating heat directly in the pan, rather than indirectly through heating the glass surface. The glass becomes hot only because the pan eventually warms it up.

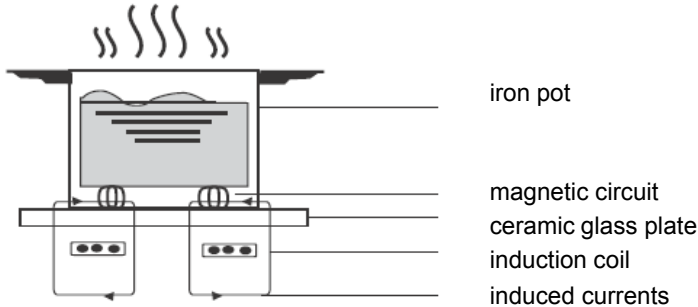

Before using your New Induction Hob

- Read this guide, taking special note of the 'Safety Warnings' section.
- Remove any protective film that may still be on your Induction hob.

Using the Touch Controls

- The controls respond to touch, so you don't need to apply any pressure.
- Use the ball of your finger, not its tip.
- You will hear a beep each time a touch is registered.
- Make sure the controls are always clean, dry, and that there is no object (e.g. an utensil or a cloth) covering them. Even a thin film of water may make the controls difficult to operate.

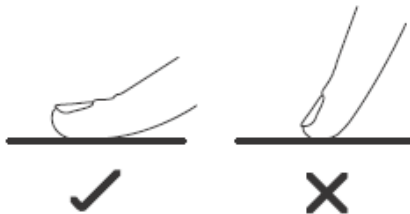

Choosing the right Cookware



- Only use cookware with a base suitable for induction cooking. Look for the induction symbol on the packaging or on the bottom of the pan.



Cooking zone	The base diameter of induction cookware	
	Minimum (mm)	Maximum (mm)
1,2,	140	220
3	220	300
4	120	160
Flexible zone	220	220x400

Using your Induction Hob

To start cooking

1. Touch the ON/OFF control.
After power on, the  buzzer beeps once, timer control show "CL", heating zone selection controls show "00", indicating that the induction hob has entered the state of standby mode.
2. Place a suitable pan on the cooking zone that you wish to use.
 - Make sure the bottom of the pan and the surface of the cooking zone are clean and dry.
3. Touching the heating zone selection control, and a indicator where you touched will flash
4. Adjust heat setting by touching the slider control.

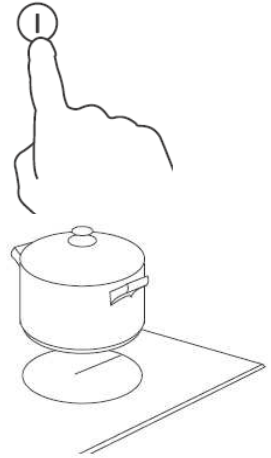

- If you don't choose a heat setting within 1 minute, the Induction hob will automatically switch off. You will need to start again at step 1.
- You can modify the heat setting at any time during cooking.

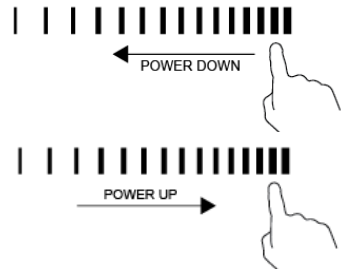

If the display flashes  alternately with the heat setting

This means that:

- you have not placed a pan on the correct cooking zone or,
- the pan you're using is not suitable for induction cooking or,
- the pan is too small or not properly centred on the cooking zone.

No heating takes place unless there is a suitable pan on the cooking zone.

The display will automatically turn off after 1 minute if no suitable pan is placed on it.

When you have finished cooking

1. Touching the heating zone selection control that you wish to switch off.
2. Turn the cooking zone off by touching the slider to the left. Make sure the display shows "0"
3. Turn the whole cooktop off by touching the ON/OFF control.
4. Beware of hot surfaces

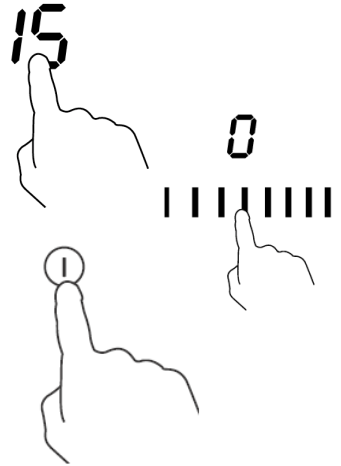

H will show which cooking zone is hot to touch. It will disappear when the surface has cooled down to a safe temperature. It can also be used as an energy saving function if you want to heat further pans, use the hotplate that is still hot.

H

Using the Boost function

Activated the boost function

1. Touching the heating zone selection control
2. Touching the boost control **B**, the zone indicator show "b" and the power reach Max.

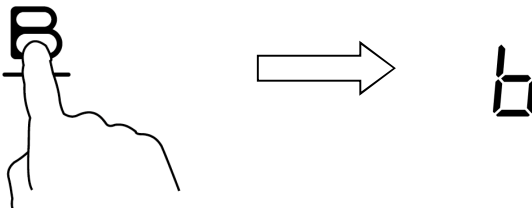

Cancel the Boost function

1. Touching the heating zone selection control that you wish to cancel the boost function
2. a: Touching the boost control "**B**", then the cooking zone will revert to its original setting.
b: Touching the slider control, then the cooking zone will revert to the level you select.

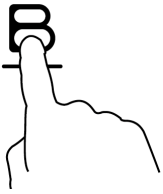

OR



- The function can work in all cooking zones
- The cooking zone returns to its original setting after 5 minutes.
- As the boost function of 1st cooking zone is activated, the 2nd cooking zone is limited under level 2 automatically. vice versa
- If the original heat setting equals 0, it will return to 15 after 5 minutes.

Using the Keep Warm function

Activated the keep warm function

1. Touching the heating zone selection control
2. Touching the keep warm control  the zone indicator show "1".

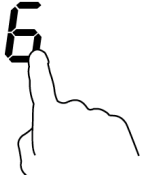
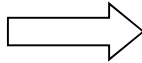
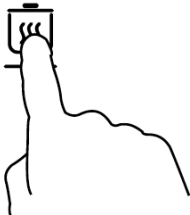

Cancel the keep warm function

1. Touching the heating zone selection control

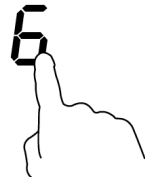

2. a: Touching the slider control, then the cooking zone will revert to the level you select.



- b: Touching the function control such as  or B , then the cooking zone will revert to you select.

FLEXIBLE AREA

- This area can be used as a single zone or as two different zones, accordingly to the cooking needs anytime.
- Flexible area is made of two independent inductors that can be controlled separately. When working as a single zone, a cookware is moved from one zone to the other one within the flexible area keeping the same power level of the zone where the cookware originally was placed, and the part that is not covered by cookware is automatically switched off.
- **Important:** Make sure to place the cookwares centered on the single cooking zone. In case of big pot, oval, rectangular and elongated pans make sure to place the pans centered on the cooking zone covering both logos. Examples of good pot placement and bad pot placement.

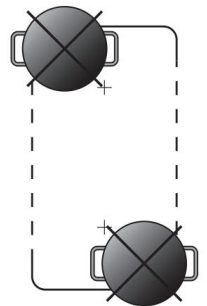
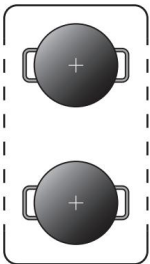

As big zone

1. To activate the flexible area as a single big zone, simply press the dedicated keys.
2. The power setting works as any other normal area.
3. If the pot is moved from the front to the rear part (or

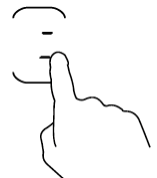

viceversa), the flexible area detects automatically the new position, keeping the same power.

4. To add a further pot, press again the dedicated keys, in order to detect the cookware.

As two independent zones

To use the flexible area as two different zones with different power settings, press the dedicated keys.

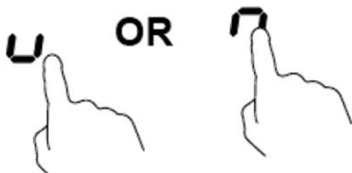

Locking the Controls

- You can lock the controls to prevent unintended use (for example children accidentally turning the cooking zones on).
- When the controls are locked, all the controls except the ON/OFF control are disabled.

To lock the controls

Touch the keylock  control. The timer indicator will show “Lo “

To unlock the controls

1. Make sure the Induction hob is turned on.
2. Touch and hold the keylock control  for a while.
3. You can now start using your Induction hob.



When the hob is in the lock mode, all the controls are disabled except the ON/OFF, you can always turn the induction hob off with the ON/OFF control in an emergency, but you shall unlock the hob first in the next operation.

Over-Temperature Protection

A temperature sensor equipped can monitor the temperature inside the Induction hob. When an excessive temperature is monitored, the Induction hob will stop operation automatically.

Detection of Small Articles

When an unsuitable size or non-magnetic pan (e.g. aluminium), or some other small item (e.g. knife, fork, key) has been left on the hob, the hob automatically goes on to standby in 1 minute. The fan will keep cooling down the induction hob for a further 1 minute.

Auto Shutdown Protection

Auto shut down is a safety protection function for your induction hob. It shut down automatically if ever you forget to turn off your cooking. The default working times for various power levels are shown in the below table:

Power level	Keep warm	1~5	6~10	11~14	15
Default working timer (hour)	2	8	4	2	1

When the pot is removed, the induction hob can stop heating immediately and the hob automatically switch off after 2 minutes.



People with a heart pace maker should consult with their doctor before using this unit.

Using the Timer

You can use the timer in two different ways:

- You can use it as a minute minder. In this case, the timer will not turn any cooking zone off when the set time is up.
- You can set it to turn cooking zones off after the set time is up.
- You can set the timer for up to 99 minutes.

Using the Timer as a Minute Minder

If you are not selecting any cooking zone

1. Make sure the cooktop is turned on.

Note: you can use the minute minder even if you're not selecting any cooking zone.

2. Touch timer control , the "10" will show in the timer display timer display where touched and the "0" flashes.



3. Set the time by touching the slider control. (e.g. 6)

4. Touch timer control again, the "1" will flash.

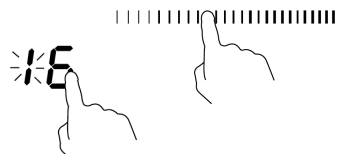

5. set the time by touching the slider control (e.g.9), now the timer you set is 96 minutes.

96

6. Buzzer will beep for 30 seconds and the timer indicator shows "00" when the setting time finished.

00

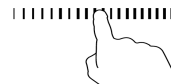

Setting the timer to turn cooking zones off

If the timer is set on one zone:

1. Touching the heating zone selection control that you want to set the timer for.
2. Touch timer control , the "10" will show in the timer display and the "0" flashes.
3. Set the time by touching the slider control. (e.g. 6)
4. Touch timer control again, the "1" will flash.
5. Set the time by touching the slider control (e.g.9), now the timer you set is 96 minutes.
6. When the time is set, it will begin to count down immediately. The display will show the remaining time and the timer indicator flash for 5 seconds.

NOTE: The red dot next to power level indicator will illuminate indicating that zone is selected.

7. When cooking timer expires, the corresponding cooking zone will be switch off automatically.

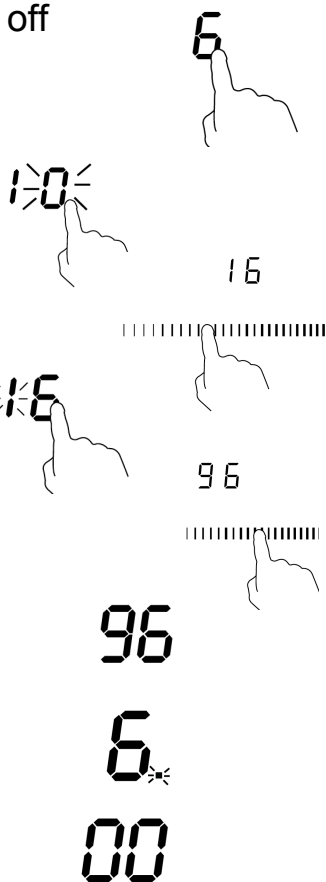

Other cooking zone will keep operating if they are turned on previously.

If the timer is set on more than one zone:

1. When you set the time for several cooking zones simultaneously, decimal dots of the relevant cooking zones are on. The minute display shows the min. timer. The dot of the corresponding zone flashes.



15

(set to 15 minutes)

(set to 45 minutes)

- 2. Once the countdown timer expires, the corresponding zone will switch off. Then it will show the new min. timer and the dot of corresponding zone will flash.

30 6

- Touch the heating zone selection control, the corresponding timer will be shown in the timer indicator.

Using the boiling cue control

You can use the function to boil water and it will remind you of the boiling water.

Activated the boiling cue function



- 1. Touching the heating zone selection control.

- 2. Touching the boiling cue control  , the zone indicator show "2L" .

Touching the boiling cue control  again, the zone indicator show "3L".

Touching the boiling cue control  for the third time, the zone indicator show "5L".

Touching the boiling cue control  for the fourth time, the zone indicator show "0".

Cancel the boiling cue function

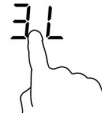

- 1. Touching the heating zone selection control.

- 2. a: Touching the slider control, then the cooking zone will revert to the level you select



- b: Touching the function control  , then the cooking zone will revert to you select.

- It is important that the water temperature is neither too hot nor too cold when cooking begins, as this could affect the final result.

- Once the water has boiled, a series of beeps is heard and the zone indicator flashes. Then give a short press on the boiling cue control  . Power 9 is displayed by default.
- The function can only work in 3rd cooking zone.
- Use pans whose diameter is as large as the graphic of the zone selected.
- Do not use cast iron cookware.
- Do not use a lid.
- As the boost function of 3rd cooking zone is activated, the 4th cooking zone is limited.

Cooking Guidelines



Take care when frying as the oil and fat heat up very quickly, particularly if you're using PowerBoost. At extremely high temperatures oil and fat will ignite spontaneously and this presents a serious fire risk.

Cooking Tips

- When food comes to the boil, reduce the temperature setting.
- Using a lid will reduce cooking times and save energy by retaining the heat.
- Minimise the amount of liquid or fat to reduce cooking times.
- Start cooking on a high setting and reduce the setting when the food has heated through.

Simmering, cooking rice

- Simmering occurs below boiling point, at around 85°C, when bubbles are just rising occasionally to the surface of the cooking liquid. It is the key to delicious soups and tender stews because the flavours develop without overcooking the food. You should also cook egg-based and flourthickened sauces below boiling point.
- Some tasks, including cooking rice by the absorption method, may require a setting higher than the lowest setting to ensure the food is cooked properly in the time recommended.

Searing steak

To cook juicy flavoursome steaks:

1. Stand the meat at room temperature for about 20 minutes before cooking.
2. Heat up a heavy-based frying pan.
3. Brush both sides of the steak with oil. Drizzle a small amount of oil into the hot pan and then lower the meat onto the hot pan.
4. Turn the steak only once during cooking. The exact cooking time will depend on the thickness of the steak and how cooked you want it. Times may vary from

about 2 – 8 minutes per side. Press the steak to gauge how cooked it is – the firmer it feels the more ‘well done’ it will be.

5. Leave the steak to rest on a warm plate for a few minutes to allow it to relax and become tender before serving.

For stir-frying

1. Choose an induction compatible flat-based wok or a large frying pan.
2. Have all the ingredients and equipment ready. Stir-frying should be quick.
If cooking large quantities, cook the food in several smaller batches.
3. Preheat the pan briefly and add two tablespoons of oil.
4. Cook any meat first, put it aside and keep warm.
5. Stir-fry the vegetables. When they are hot but still crisp, turn the cooking zone to a lower setting, return the meat to the pan and add your sauce.
6. Stir the ingredients gently to make sure they are heated through.
7. Serve immediately.

Heat Settings

The settings below are guidelines only. The exact setting will depend on several factors, including your cookware and the amount you are cooking. Experiment with the induction hob to find the settings that best suit you.

Heat setting	Suitability
1 - 2	<ul style="list-style-type: none">• delicate warming for small amounts of food• melting chocolate, butter, and foods that burn quickly• gentle simmering• slow warming
3 - 5	<ul style="list-style-type: none">• reheating• rapid simmering• cooking rice
6 - 11	<ul style="list-style-type: none">• pancakes
12 - 14	<ul style="list-style-type: none">• sautéing• cooking pasta
15/P	<ul style="list-style-type: none">• stir-frying• searing• bringing soup to the boil• boiling water

Care and Cleaning

The settings below are guidelines only. The exact setting will depend on several factors, including your cookware and the amount you are cooking. Experiment with the cooktop to find the settings that best suit you.

What?	How?	Important!
<p>Everyday soiling on glass (fingerprints, marks, stains left by food or non-sugary spillovers on the glass)</p>	<ol style="list-style-type: none"> 1. Switch the power to the cooktop off. 2. Apply a cooktop cleaner while the glass is still warm (but not hot!) 3. Rinse and wipe dry with a clean cloth or paper towel. 4. Switch the power to the cooktop back on. 	<ul style="list-style-type: none"> • When the power to the cooktop is switched off, there will be no 'hot surface' indication but the cooking zone may still be hot! Take extreme care. • Heavy-duty scourers, some nylon scourers and harsh/abrasive cleaning agents may scratch the glass. Always read the label to check if your cleaner or scourer is suitable. • Never leave cleaning residue on the cooktop: the glass may become stained.
<p>Boilovers, melts, and hot sugary spills on the glass</p>	<p>Remove these immediately with a fish slice, palette knife or razor blade scraper suitable for Induction glass cooktops, but beware of hot cooking zone surfaces:</p> <ol style="list-style-type: none"> 1. Switch the power to the cooktop off at the wall. 2. Hold the blade or utensil at a 30° angle and scrape the soiling or spill to a cool area of the cooktop. 3. Clean the soiling or spill up with a dish cloth or paper towel. 4. Follow steps 2 to 4 for 'Everyday soiling on glass' above. 	<ul style="list-style-type: none"> • Remove stains left by melts and sugary food or spillovers as soon as possible. If left to cool on the glass, they may be difficult to remove or even permanently damage the glass surface. • Cut hazard: when the safety cover is retracted, the blade in a scraper is razor-sharp. Use with extreme care and always store safely and out of reach of children.
<p>Spillovers on the touch controls</p>	<ol style="list-style-type: none"> 1. Switch the power to the cooktop off. 2. Soak up the spill 3. Wipe the touch control area with a clean damp sponge or cloth. 4. Wipe the area completely dry with a paper towel. 5. Switch the power to the cooktop back on. 	<ul style="list-style-type: none"> • The cooktop may beep and turn itself off, and the touch controls may not function while there is liquid on them. Make sure you wipe the touch control area dry before turning the cooktop back on.

Hints and Tips

Problem	Possible causes	What to do
The induction hob cannot be turned on.	No power.	Make sure the induction hob is connected to the power supply and that it is switched on. Check whether there is a power outage in your home or area. If you've checked everything and the problem persists, call a qualified technician.
The touch controls are unresponsive.	The controls are locked.	Unlock the controls. See section 'Using your induction cooktop' for instructions.
The touch controls are difficult to operate.	There may be a slight film of water over the controls or you may be using the tip of your finger when touching the controls.	Make sure the touch control area is dry and use the ball of your finger when touching the controls.
The glass is being scratched.	Rough-edged cookware. Unsuitable, abrasive scourer or cleaning products being used.	Use cookware with flat and smooth bases. See 'Choosing the right cookware'. See 'Care and cleaning'.
Some pans make crackling or clicking noises.	This may be caused by the construction of your cookware (layers of different metals vibrating differently).	This is normal for cookware and does not indicate a fault.
The induction hob makes a low humming noise when used on a high heat setting.	This is caused by the technology of induction cooking.	This is normal, but the noise should quieten down or disappear completely when you decrease the heat setting.
Fan noise coming from the induction hob.	A cooling fan built into your induction hob has come on to prevent the electronics from overheating. It may continue to run even after you've turned the induction hob off.	This is normal and needs no action. Do not switch the power to the induction hob off at the wall while the fan is running.

Pans do not become hot and appears in the display.	<p>The induction hob cannot detect the pan because it is not suitable for induction cooking.</p> <p>The induction hob cannot detect the pan because it is too small for the cooking zone or not properly centred on it.</p>	<p>Use cookware suitable for induction cooking. See section 'Choosing the right cookware'.</p> <p>Centre the pan and make sure that its base matches the size of the cooking zone.</p>
The induction hob or a cooking zone has turned itself off unexpectedly, a tone sounds and an error code is displayed (typically alternating with one or two digits in the cooking timer display).	Technical fault.	Please note down the error letters and numbers, switch the power to the induction hob off at the wall, and contact a qualified technician.

Failure Display and Inspection

If an abnormality comes up, the induction hob will enter the protective state automatically and display corresponding protective codes:

Problem	Possible causes	What to do
F1-F6	Temperature sensor failure	Please contact the supplier.
F9-FA	Temperature sensor of the IGBT failure.	Please contact the supplier.
FC	The connection between the display board and the main board is fail	Please contact the supplier.
E1/E2	Abnormal supply voltage	Please inspect whether power supply is normal. Power on after the power supply is normal.
E3/E4	Temperature sensor of the ceramic glass plate Is high	Please restart after the induction hob cools down.
E5	Temperature sensor of the IGBT Is high	Please restart after the induction hob cools down.

if there are anyone zone of the flexible area to be protected, the flexible area selection control will not be able to use.

The above are the judgment and inspection of common failures.

Please do not disassemble the unit by yourself to avoid any dangers and damages to the induction hob.

The oven (according to the models)

Always keep small children away from the oven while it is in use.

Before cooking for the first time switch the oven on and allow it to heat up while empty. At this point you may notice a slightly odour, this is perfectly normal and occurs as the protective covering which surrounds the insulating panels is gently removed.

This covering is designed for transit purposes only and its removal will not affect the performance of your oven.

Prior to use simply wipe the oven interior with a damp cloth, it is then ready for cooking.

Electronic control

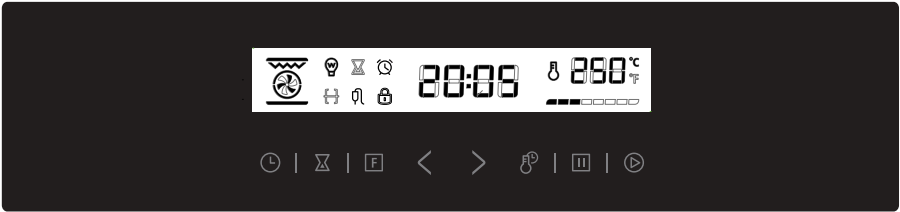

Symbol	Function description
	Oven Lamp: Which enables the user to observe the progress of cooking without opening the door. Oven lamp will light for all cooking functions.
	Defrost: The circulation of air at room temperature enables quicker thawing of frozen food, (without the use of any heat). It's a gentle but quick way to speed up the defrosting time and thawing of ready-made dishes and cream filled produce etc.
	Bottom heater: A concealed element in the bottom of the oven provides a more concentrative heat to the base of food without browning. This is ideal for slow cooking dishes such as casseroles, stews, pastries and pizzas where a crispy base is desired. The temperature can be set within the range of 60-120°C. The default temperature is 60°C.
	Conventional cooking: The top and bottom work together to provide convectional cooking. The temperature can be set within the range of 50-250°C. The default temperature is 220°C.
	Convention with fan: Combination of the fan and both heating element provides more even heat penetration, saving up to 30-40% of energy. Dishes are lightly browned on the outside and still moist on the inside. Note: This function is suitable for grilling or roasting big pieces of meat at a higher temperature. The temperature can be set within the range of 50-250°C. The default temperature is 220°C.
	Radiant grilling: The inner grill element switches on and off to maintain temperature. The temperature can be set within the range of 180-240°C. The default temperature is 210°C. This is optional function that can be work with rotisserie motor.
	Double grilling: The inside radiant element and top element are working. The temperature can be set within the range of 180-240°C. The default temperature is 210°C. This is optional function that can be work with rotisserie motor.
	Double grilling with fan: The inside radiant element and top element are working with fan. The temperature can be set within the range of 180-240°C. The default temperature is 210°C. This is optional function that can be work with rotisserie motor.
	Convection: An element around the convection fan provides an additional source of heat for convection style cooking. In convection mode the fan automatically comes on to improve air circulation within the oven and creates an even heat for cooking. The temperature can be set within the range of 50-240°C. The default temperature is 180°C.

Knobs control

COOKING METHODS (according to models)

ELECTRICAL OVEN : conventional oven (from 50 to MAX)

MULTIFUNCTION OVEN : conventional cooking, fan cooking, lower element, grill, fan assisted grill.



Lighting the oven



Defrosting



Conventional cooking : top and bottom heating elements are used together.



Preheat the oven for about ten minutes. This method is ideal for all

traditional roasting and baking.

For sealing red meats, roast beef, leg of lamb, game, bread, foil-wrapped food (papillotes), flaky pastry. Mid shelf position recommended.



Fan assisted multilevel oven

Cooking of similar or different foods placed on different shelves (up to 2 levels at a time).



Fan cooking : both top and bottom heating elements are used and the fan circulates the air inside the oven. Recommended for poultry, pastries, fish and vegetables. Heat penetrates the food better and both the cooking and preheating times are reduced. Different foods can be cooked at the same time in one or more positions. This function provides even heat distribution and does not mix the smells. Allow about ten minutes extra when cooking foods at the same time.



Lower element : using the lower element. Ideal for cooking all pastry based dishes.

This allows you to cook dry tart pastry without over cooking the fruit filling. Use this for flans, quiches, tarts, pie and any cooking that needs more heat and radiation from below.



Grill : Caution: In this function, the adjustment knob of the temperature must be set in the position indicated with "G". Using the top level element.

Success is guaranteed for mixed grills, kebabs and au gratin dishes. Five minutes preheating is required to get the element hot. Use the grill when the door is closed.



Fan assisted grilling : Caution: In this function, the adjustment knob of the temperature must be set in the position indicated with "G".

The top heating element is used in conjunction with the fan circulating the air inside the oven. Ideal for cooking thicker food stuffs, whole pieces of meat such as roast pork, poultry, etc. Preheating is necessary for red meats but not for white meats. Place the food to be grilled directly on the shelf centrally, at the middle level.

Slide the drip tray under the shelf to collect the juices. Make sure that the food is not too close to the grill. Turn the food over halfway through cooking.



Rotisserie (in option) : the top heating element is used in conjunction with the rotisserie providing the real flavour of a traditional roast.

Control knob for oven

Use this control knob to set the heat output of the oven

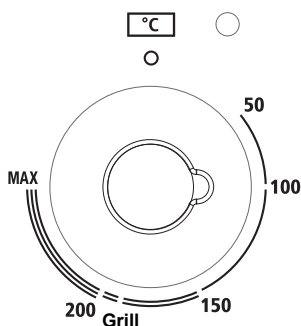

Setting	Meaning
50 - Max	Oven temperature range in °C
50 - Grill	Grill temperature range in °C

Function selector (according to the models)

Use this knob to set the desired cooking function

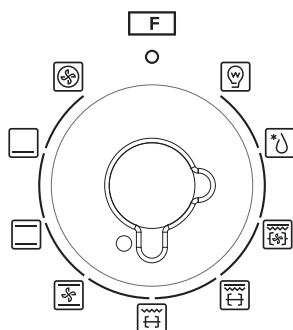

Oven Accessories

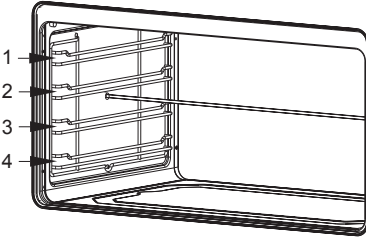

The accessories can be inserted in the oven in 4 different shelf positions.

You can pull the accessories two-thirds of the way out without them tipping.

This allows meals to be removed easily.

You can buy accessories from the after-sales service or from specialist retailers.

Accessory

Description

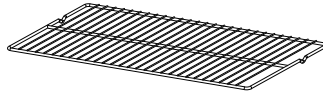

Baking and roasting shelf

For ovenware, cake tins, roasts, grilling and frozen meals.

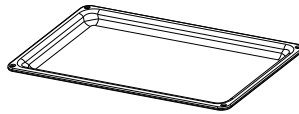

Enamelled baking tray

For moist cakes, pastries, frozen meals and large roasts. Can also be inserted underneath the wire rack or rotary spit and used as a drip tray to collect fat.



Rotary spit

For roasts and large pieces of poultry. Use only in combination with the enamelled baking tray.

Using the electronic oven control

OPERATION INSTRUCTIONS

1. Clock Setting

After connecting the unit to the power, the symbols "0:00" will be visible on the display.

1> Press "⌚", the hour figures will flash.

2> Press "◀▶" to adjust the hour figures, (time should be within 0--23).

3> Press "⌚", the minutes will flash.

4> Press "◀▶" to adjust the minutes setting, (time should be within 0-- 9).

5> Press "⌚" to finish the clock settings. ":" will flash, and the time will be illuminated.

Note: The clock is 24 hours. After power on, if not set, the clock will show "0:00".

2. Function Setting

1> Press "F" to choose the cooking function you require. The related indicator will illuminated .

2> Press "◀▶" to adjust the cooking time and adjust the temperature before press "⏸" to switch .



3> Press "▶" to confirm the start of cooking.

4> If step 2 is ignored, Press "▶" to confirm the start of cooking and the default time is 9 hours, the default temperature will display on the LCD.

NOTE:

1>The step quantities for the adjustment time of the coding switch are as follow:



0--0:30min: step 1 minute 0:30--9:00hour :step 5 minutes

2>The step quantities for the adjustment of temperature is 5°C, and "  " "  " can not adjust the temperature.

3>Press "  " to adjust the cooking time when cooking begins. Then press "  " to confirm.

If "  " not pressed within 5 seconds, the oven will revert back to the previous time to continue cooking.

4>Press "  ", the "  " will show, then press "  " to adjust the temperature when cooking begins.

Then press "  " to start cooking. If "  " not pressed in 5 seconds, the oven will revert back to the previous temperature to continue cooking.



3.Lamp Setting

1> Press "  " to select the relevant function, then the corresponding icon will be on.

2> Press "  " button to start, "0:00" and lamp icon "  " will light up, " : " will flash.

4.Inquiring function



In the following states, you can use inquiring function, after 3 seconds return to the current state.



1> During working state, if the clock was set, press "  " button to see the current time; if the reminder function was set, press "  " button to see the time of reminder.

2> In reminding state, if the clock was set, press "  " button to see the current time.

3> In clock display state, if the reservation function was set, press "  " button to see the time of reservation.

5. Child lock function



To Lock : press "  " and "  " simultaneously for 3 seconds, there will be a long "beeping" sound and the "  " will be illuminated.

Lock quitting : press "  " and "  " simultaneously for 3 seconds, there will be a long "beeping" sound indicating the child-lock is released.



Note: During working mode, if you want to stop cooking, press stop button quickly. Do not need to long pressing on stop button, it is invalid.

6. Reminder Function:

The oven has 9 hours reminder, this function will help to remind you to start cooking in a certain time from 1 minute to 9 hours. Only when oven in standby mode, the reminder can be set. Follow below to set the reminder:



1> Press reminder setting button "  " and the display shows "  " and "AL";



2> Press "  " to set the time of reminder.

3> Press "  " to confirm setting. " : " will be flash and the indicator for reminder "  " will light. The time will count down.

Note: The oven buzzer will sound for 10 times after the time back to the zero hour. "  " symbol disappears on the screen to remind you to start cooking. You can cancel the reminder during setting by pressing the stop button; After the reminder has been set, you can cancel it by pressing stop button twice.

7. Start/Pause/Cancel Function

1> If the cooking time has been set, press "  " to start cooking. If the cooking is paused, press "  " to resume cooking.

2> During cooking process, press "  " once to pause the cooking. Press "  " twice to cancel the cooking.

8. Reservation Function

Only when the clock has been set, delay function can be used. In standby mode,

- 1, Press "⏸" 2 timers. the display shows "⏸" and "End".
- 2, Press "< >" to set the hour of the cooking ending time of reservation.
- 3, Press "⏸" button again;
- 4, Press "< >" to set the minute of the cooking ending time of reservation.
- 5, Press "F" to choose the cooking function you require.
- 6, After set the cooking time and temperature, press "⏻" to start.

Note:

Subtract the cooking time from the cooking ending time, you will get the time that oven starts to cook.

9. Energy-Saving Function

- 1> In waiting state and reminding state, press "⏻" for three seconds, the LCD display will go off and set to energy-saving mode.
- 2> If no operation in 10 minutes under waiting state, the LCD display will go off and go into energy-saving mode.
- 3> Under the energy-saving mode, press any key can quit the energy-saving mode.

10. Meat probe function:

1> In waiting state, insert the meat probe, the LCD will display "PROB" and the icon "🍖" will light.

2> Press "<>" to choose function you need. The related indicator will illuminated.

Functional sequence diagram: . Press "⏻" to confirm function setting.

3> Press "<>" to adjust the temperature. Press "⏻" to confirm temperature probe.

The small LCD display the temperature and the big LCD display "PROB".

4> The buzzer will sound five times when cooking finish. The setting temperature lights when the setting temperatures arrives. If the meat probe pulled out, it will turn back to waiting state.

Note: A). The range of the temperature is 50-150 degrees. B). During probe function, the cooking time can not be set. C). During cooking process, press stop button once, it will stop cooking, LED flash; Press stop button again, cancel the current cooking. D). Pull out the meat probe from the oven, it will cancel all the program. E) If the display shows "Er-3" after the programme has been started, it means that the temperature sensor short circuit.

11. Note

- 1> The oven lamp will be on for all functions.
- 2> Once the cooking programme has been set and the "⏻" button is not pressed within 5 minutes, the current time will be displayed or turn back to waiting state. The setting program will be invalid.
- 3> The buzzer will sound once when effectively pressed, if not effectively pressed there will be no response.
- 4> The buzzer will sound five times to remind you when cooking has finished.

ACCESSORIES

Meat probe : Before using, insert the probe into the center of the thickest portion of meat or into the inner thigh or breast of poultry, away from fat or bone. Place food in oven and connect the meat probe. Keep probe as far away from heat source as possible. Close oven door.

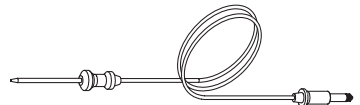

Using the programmer of cooking (according to models)

Main functions (for some models)

1. Time function, keep the time in 24 hours.
2. Make an reservation for the oven work time, and can set anytime in 24 hours.
3. Set the oven work time, the longest maybe 10 hours.

Operation Panel and Instructions (for some models)

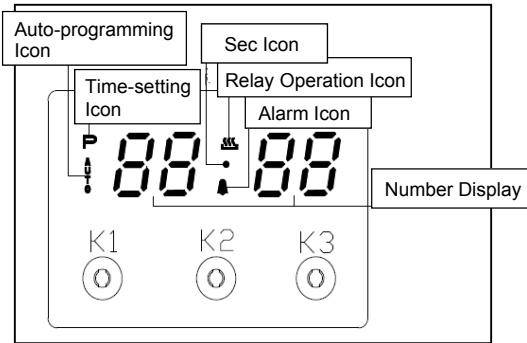

1 List of functions

Instructions from left to right: Key1, Key2, Key3.

Key1 Decrease Key

Key2 Mode Key

Key3 Increase Key

Note: Press Key 1 and Key 3 under the setting mode, which changes the time by one minute either up or down. If keep pressing them, the number will be up or down quickly.

2 Icon Instructions

“Auto-programming icon”: it will flash when setting automatic program and the end of automatic program. If automatic program has been set, after 5s, it will keep lighting up. At the end of automatic program, the flash will be off when resetting the clock or it will keep lighting up when resetting automatic program after 5s.

“Time-setting Icon” will flash when setting time.

“Sec Icon” and “Alarm Icon” are flashing under the mode of time setting and alarm setting after 5s of setting, it will turn to lighting up.

“Relay Operation Icon” shows the working state of relays. The icon will keep lighting up if contacts are connected, and will be off if contacts are disconnected.

“Number Display” is LED Nixie Tube.

Control Function and Instructions

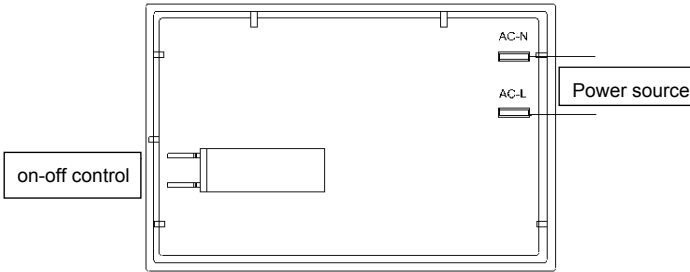

As shown in the picture, on-off control is used to control heating components of oven, the left is power source which can be connected under the 220V.

1、 Time Adjustment after Starting up

When the power is on, it shows 12: 00 and flashes. The relay contact is disconnected, auto-programming icon keeps lighting up, time setting icon flashes. Press K1 or K3 to adjust the present time or press K2 to get into the working mode. The relay contact is connected.

2、 Alarm and Buzz Function

Press K2 once under the common mode: “Alarm Icon” flashes. Press K1 or K3 to adjust the present alarm clock.

5s after adjusting to the time you need, “Alarm Icon” keeps lighting on, and will work after setting up. In this case, it will show alarm time.

When alarm counts down to zero, alarming program ends, alarm icon flashes, and the buzzer is buzzing. Press any key to stop the buzzing or it will turn off automatically after 2 minutes.

3、 Auto-programming Setting and Instructions

① Semiautomatic program mode

Use this setting for oven working time, automatic heating switch-off at the end of setting time, buzzer will inform the user.

Press K2 twice to get into the duration time setting. Or press K2 three times to get into the end time setting. “Auto-programming Icon” flashes. Press K1 and K3 to adjust continuous time and end time.

5s after setting, it will work automatically, “ Auto-programming Icon” keeps lighting up. If continuous time is 0, turn off the relay contact, and “ Relay Operation Icon” is dark, “ Auto-programming Icon” flashes, the buzzer is buzzing.

This mode's range of continuous time and end time:

Adjustment range for continuous time: > 0 but ≤ 10 hours

Adjustment range for end time: $\text{present time} < \text{end time} \leq \text{present time} + 10 \text{ hours}$

If meet this standard: $\text{end time} = \text{present time} + \text{continuous time}$

For example: the present time is 2:00, then the max. end time is adjusted to 12:00 ($2:00+10:00=12:00$). When the end time is adjusted to 12:00, then the continuous time is 10:00.

5s after adjusted, automatic program is working. After 10 hours, if continuous time is counting down to 0, turn off the relay contact, and "Relay Operation Icon" is dark, "Auto-programming Icon" flashes, the buzzer is buzzing.

Note:

1. only use this setting for either continuous time or end time.
For example: the present time is 2:00, and if let the oven work for 3 hours, set the continuous time to 3:00, and the end time will automatically change to 5:00 and vice versa.
2. If the continuous time is equal to 0 or the end time is equal to the present time, it means that the automatic program is over.
3. When the automatic program is over, the continuous time is 0 and the end time is equal to the present time.

② Automatic Mode

Use this mode for setting oven's continuous time and end time, which means make an appointment to boot. When the time is over, it will automatically turn off the heating and the buzzer is buzzing to inform the user.

Press K2 twice to get into the continuous time setting mode under the common mode, press K2 again to get into the end time setting mode.

When the continuous time setting is ok or the end time setting is ok, then press K2 to get into the other kind of automatic program time setting, "Auto-programming Icon" flashes, press K1 and K3 to adjust continuous time and end time.

5s after automatic program setting, it will automatically work, and "Auto-programming Icon" keeps lighting up. Turn off the relay contact and the icon is dark. When work until the starting time, the relay contact is connected, the icon is light. When the continuous time is counting down, if the continuous time is 0, turn off the relay contact, "Relay Operation Icon" is dark, "Auto-programming Icon" flashes and the buzzer is buzzing.

The continuous time and the end time under this mode will be set as follow:

Starting time = end time - continuous time

For example, the present time is 2:00, set the continuous time to 3:00 and the end time to 10:00, then the starting time is 7:00 (7:00 = 10:00 - 3:00). The relay contact is connected and its icon is light. After working for continuous 3 hours, the continuous time is 0, turn off the relay contact, “Relay Operation Icon” is dark, “Auto-programming Icon” flashes, the buzzer is buzzing.

Note:

1. End time > present time+ continuous time, but ≤23 hours and 59 minutes
For example: the present time is 2:00, continuous time is 0:01, then the range for end time is 2:02 (2:02 > 2:00+1)
2. Continuous time ≥1 minute, continuous time and end time both will be set.
3. If the continuous time is equal to 0 or the end time is equal to the present time, it means the automatic program is over.
4. When the automatic program is over, the continuous time is 0, the end time is the same with the present time.

4、 Cancel Function

When semiautomatic or automatic function is starting, press K1 and K3 at the same time which can cancel the automatic mode.
(to cancel continuous time and end time).

The storage compartment

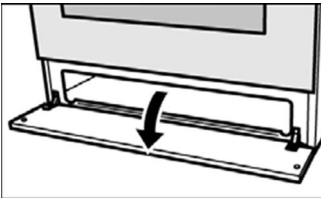

Open the storage compartment by folding down the fascia panel.

This compartment can be used to store hob or oven accessories.

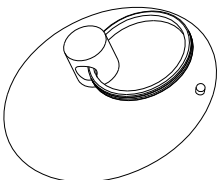

There is a plastic sucker in some models can help you open the drawer.

Risk of fire.

Never leave combustible items in the storage compartment.

Before using for the first time

Please read the following instructions before using your appliance for the first time.
Remove the appliance packaging and dispose of this appropriately.

Baking out the oven

Cooking compartment initial cleaning

Remove the accessories from the cooking compartment.
Completely remove any leftover packaging, e.g. small pieces of polystyrene, from the cooking compartment.
Some parts are covered with a protective film. Remove this film.

1. Clean the outside of the appliance with a soft, damp cloth.
2. If the hook-in racks have already been fitted, unhook and remove them. For information on removing the racks, see the section **Removing and refitting hook-in racks.**
3. Clean the cooking compartment with warm soapy water.

Heating up the oven (according to the model)

To remove the new cooker smell, heat up the oven when it is empty and closed.

1. Put the switch in position  conventional cooking. Set the thermostat to 200 ° C.
2. After 25 minutes, switch the oven off by turning the control knob clockwise to position 0.

1. Put the switch in position  fan assisted multi-level oven. Set the thermostat to 200 ° C.
2. After 25 minutes, switch the oven off by turning the control knob clockwise to position 0.

Heating up the grill

1. Put the switch in position grill 
2. After 25 minutes, switch the oven off by turning the control knob clockwise to position 0.

Rinsing cooking compartment after initial cleaning

Clean the cooking compartment with hot soapy water. Refit the hook-in racks.

Using the rotary spit

The rotary spit can be used to cook joints such as rolled joints and poultry with excellent results. The meat is roasted thoroughly and evenly.

The rotary spit function only when the switch is in position grill.

Preparing joints

Place the joint as centrally as possible on the rotary spit and secure it at both ends with the retaining clips.

You can also truss the joint with string. With poultry, bind the ends of the wings underneath the back and the thighs against the body. This will prevent them from becoming too dark. Pierce the skin on the underside of the wings to allow the fat to escape.

Inserting the rotary spit

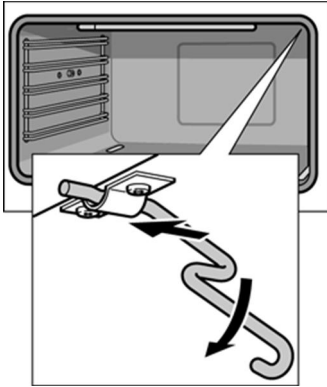

Insert the rotary spit as follows:

1. Hook the spit holder into the bracket on the ceiling of the cooking compartment.
If you require to preheat the oven, hook in the holder before preheating.

Risk of burns

Never touch the hot surfaces of the cooking compartment or the heating elements. Children must be kept at a safe distance from the appliance at all times. Open the appliance door carefully. Hot steam may escape.

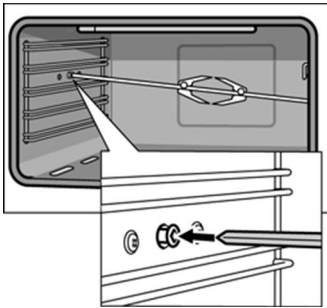

2. If the oven has been preheated, only attach the rotary spit if you are using an oven cloth or wearing (thermal) oven gloves. To attach the spit, slide one end into the recessed adapter in the left-hand side panel of the cooking compartment.

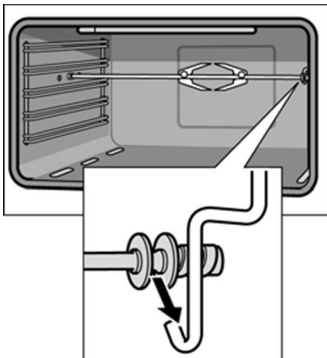

3. Hook the other end into the holder.
4. Pour a little bit of water into the baking tray and slide this into shelf position 1 to collect the run-off fat.

Removing the rotary spit



Risk of burns.

Never touch the hot surfaces of the cooking compartment or the heating elements. Children must be kept at a safe distance from the appliance at all times.

Open the appliance door carefully.

Hot steam may escape.



Risk of burns.

Never touch the rotary spit or other accessories directly when they are hot.

Always wear oven gloves or heat-resistant gloves when handling hot accessories.

Remove the rotary spit as follows:

1. Carefully open the appliance door. Carefully remove the rotary spit from the holder.

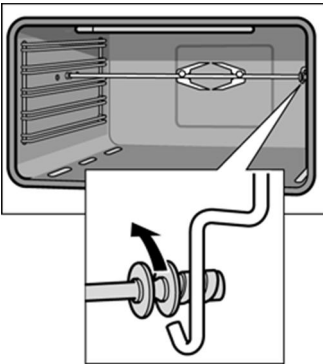

2. Carefully withdraw the rotary spit from the recessed adapter in the side panel and remove it from the oven.
3. Take out the baking tray.

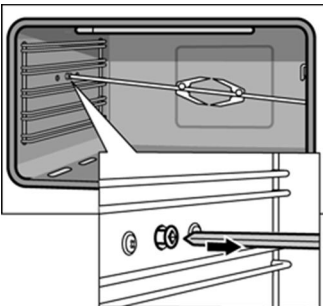

Cleaning and care



Never use high-pressure cleaners or steam jets.
Risk of short circuit.

Never use caustic or abrasive cleaning agents.
These could damage the surface. If such an agent gets on the front of the appliance, wipe it off immediately with water.

Do not clean any surfaces of the appliance while they are hot.

Switching on the oven lighting

To make it easier to clean the oven, you can switch on the oven lighting.

To switch on the lighting, press the function button for oven lighting until it locks into place.

Catalytic cooking compartment panels

The catalytic cooking compartment panels are coated with self-cleaning enamel.

The surfaces clean themselves while the oven is in operation. Larger splashes will only be removed after the oven has been used several times.

Self-cleaning surfaces

The rear and side walls are protected with catalytic panelling.

Never clean these surfaces with oven cleaner.

Slight discolouration of the enamel does not affect automatic self-cleaning.

OPTIONAL: ONLY FOR THE MODELS EQUIPPED WITH TELESCOPIC RAILS

The oven is equipped with telescopic rails to position the pan and wire grid (Fig. 1).

You can change the position, depending on your personal taste and needs of different foods (Fig. 2).

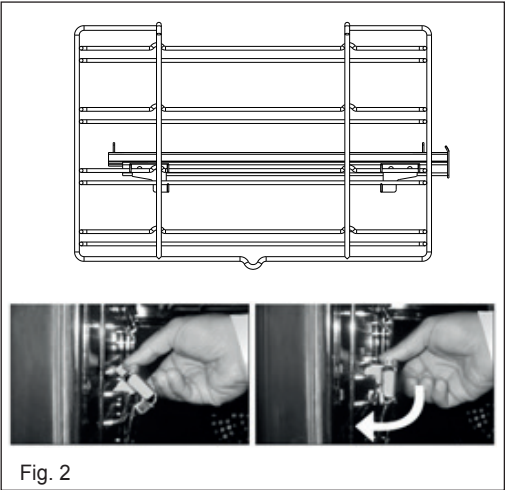
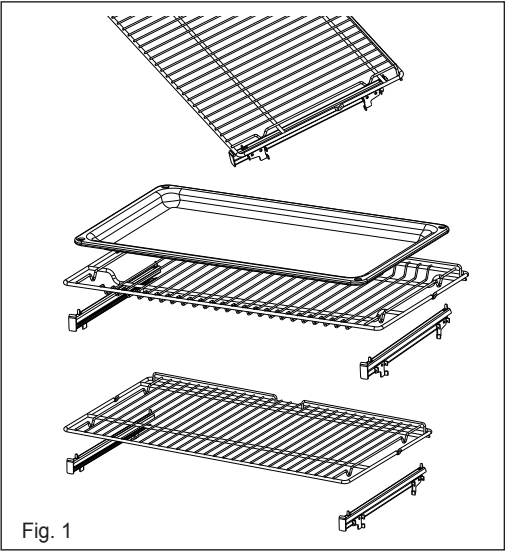

Using the correct cleaning agent

Do not use cleaning agents that contain abrasive substances or acids, or cleaning aids such as steel wool or stainless steel sponges. These could damage the surfaces.

Appliance parts	Cleaning agent and cleaning aid
Appliance door glass panel	<p>☞ Use glass cleaner.</p> <p>Risk of injury. The lower edge of the door may have sharp edges. Clean the door and glass panels with care.</p> <p>☞ Do not use a glass scraper.</p>
Control panel and knobs	☞ Wipe with a damp, soft cloth.
Seal (on the cooking compartment)	☞ Use warm soapy water.
Hook-in racks	☞ Use warm soapy water.
Cooking compartment Enamelled surfaces	☞ Use warm soapy water; Dry off with a soft cloth.
Appliance exterior Stainless steel surfaces	<p>☞ Use warm soapy water; Dry off with a soft cloth.</p> <p>☞ Always remove flecks of limescale, grease, starch and albumin (e.g. egg white) immediately.</p> <p>☞ Special stainless steel cleaners are available from the after-sales service or specialist shops.</p>
Glass cover (in front of the oven lighting)	☞ Use warm soapy water.
Pan support	<p>☞ Use warm soapy water.</p> <p>☞ Do not clean the pan supports in the dishwasher.</p>
Appliance parts	Cleaning agent and cleaning aid
Accessory	☞ Soak in hot soapy water. Clean with a brush or sponge.

Cleaning the interior glass of the oven

The interior glass of the oven door can be removed: with the door in the semi-open position, use both hands to remove the glass .After cleaning, refit the the glass by proseeding in reverse order.

Note

In some models, the glass is screenprinted. In this case, when refitting the glass make sure the screenprinted part is legible when the oven door is opened.

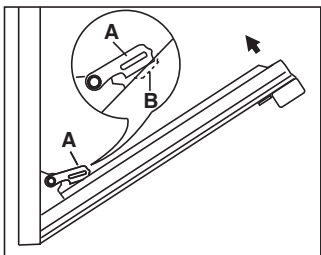
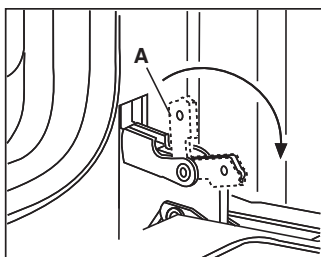

The inner glass of the oven

The inner glass of the oven door can be removed:

1. Open the oven door completely.
2. Flip the hinge hooks "A" outwards.
3. Shut the oven door slowly until it reaches hooks "A", making sure these are locked into slots "B" of the oven door.
4. With the door in a semi-open position, remove the screws D and E by screwdriver, and the profile F.
5. Use both hands to remove the glass.
6. After cleaning, refit the glass by proceeding in reverse order.

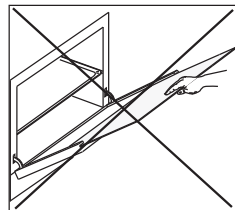
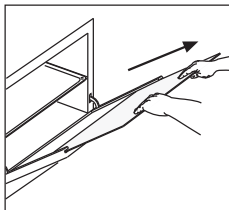
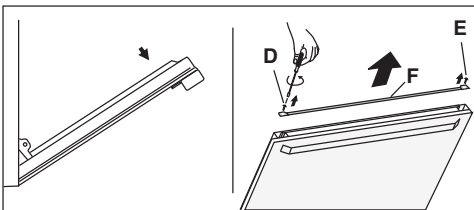

The inner glass of the oven with fixing snap (only for the models where is provided)

The inner glass of the oven door can be removed:

1. Open the oven door completely.
2. Flip the hinge hooks "A" outwards.
3. Shut the oven door slowly until it reaches hooks "A", making sure that hinges are locked into slots "B" of the oven door.
4. With the door in a semi-open position, press the two buttons C on the upper profile, and extract the profile.
5. Use both hands to remove the glass.
6. After cleaning, refit the glass by proceeding in reverse order.

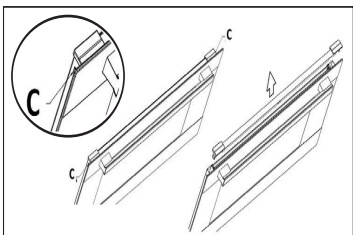

Removing and fitting the appliance door

You can remove the appliance door for easier cleaning.

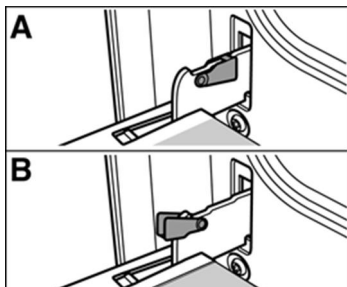

The hinges of the appliance door are each secured by a locking lever. When the locking lever is folded in (A), the appliance door is secured. It cannot be unhinged. If the locking lever is open (B), only the hinge is secured, and you can remove the appliance door.

Risk of injury.

Do not reach inside the hinge.

Removing the appliance door

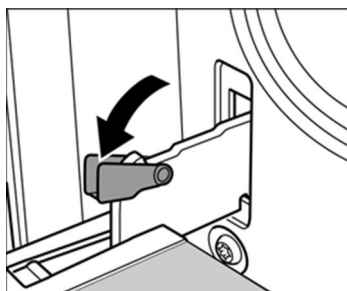

Proceed as follows:

1. Open the appliance door.
2. Lift up the locking levers on both sides.

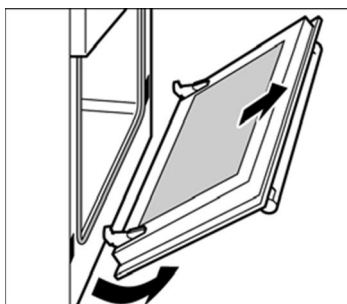

3. Close the appliance door until you feel resistance at an angle of around 15° (in relation to the closed appliance door).
4. Grip the door on either side with both hands.
5. Close the appliance door a little further.
6. Lift the door upwards and at an angle to remove it.

Do not disassemble the door.

Fitting the appliance door

Proceed as follows:

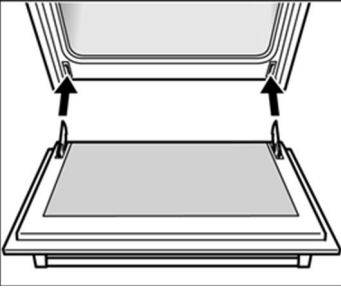

1. Hold the appliance door at an angle.
2. Insert both hinges, left and right, into the supports.

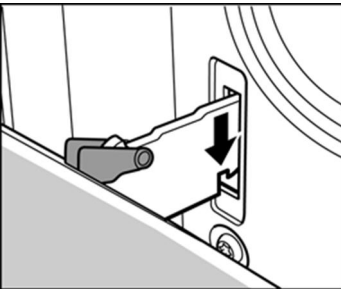

3. Position the door so that the hinge grooves engage on both sides.
4. Open the appliance door.



5. Fold in the locking levers on both sides.
6. Close the appliance door.

Removing and inserting the hook-in racks

You can remove the hook-in racks in order to clean them separately.

The hook-in racks are all fixed to the walls of the cooking compartment at four points.

To remove the hook-in racks, proceed as follows:

1. Undo the screw on the bottom the hooking rack. The lower hooks of the hook-in rack are released

Removing the hook-in racks

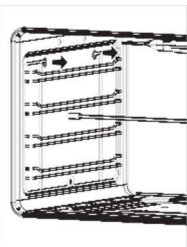
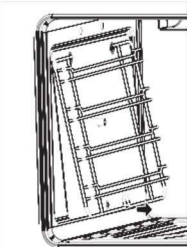

2. Take hold of the top of the hook-in rack and screw on the screw on the bottom the hook-in rack again.

Inserting the hook-in rack

To reinsert the hook-in racks, proceed as follows:

1. Insert the upper hooks into the drill holes in the side panel.



2. Pull the hook-in rack slightly downwards and insert the lower hooks into the drill holes.

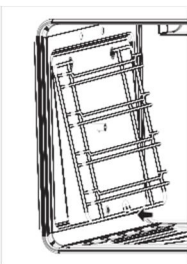

Faults and the after-sales service

Malfunctions often have simple explanations. Please read the following notes before calling the aftersales service.

Fault	Possible cause	Remedial action
The door panel steams up when the oven is hot.	Normal occurrence; caused by the difference in temperature.	Not possible; this has no effect on oven performance.
The appliance does not work.	Defective circuit breaker	Look in the fuse box and check that the circuit breaker for the appliance is in working order.
	Power cut	Check whether the kitchen light works, for example.
All dishes that are prepared in the oven become burnt very quickly.	Thermostat faulty	Call the after-sales service.
The oven lighting has failed.	Oven light is faulty	Replace the oven light. (see section "Replacing oven light")

Repairs may only be carried out by fully trained after-sales service engineers.

If your appliance is not repaired professionally, you may be exposing yourself to substantial risks.

Replacing the oven light bulb

WARNING: Ensure that the appliance is switched off before replacing the lamp to avoid the possibility of electric shock

If the oven light bulb fails, it must be replaced. Replacement heat-resistant bulbs can be obtained from the after-sales service or from specialist retailers. Please specify the SN number of your appliance. Do not use any other type of bulb.

Proceed as follows:

1. Switch off the relevant circuit breaker.
2. Open the appliance door.
3. Lay a tea towel in the cooking compartment if it is cold to prevent damage.
4. Unscrew the glass cover from the bulb inside the cooking compartment by turning it anti-clockwise.
5. Replace the bulb with one of the same type.

Voltage: 230 V

Power: 25 W

Thread: G9

Temperature resistance: 300°C

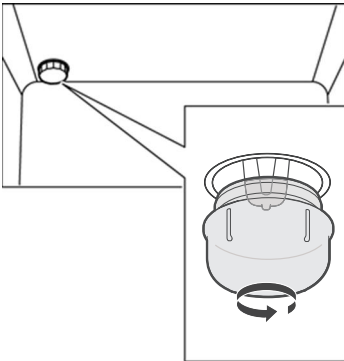

6. Screw on the glass cover again.
7. Remove the tea towel and switch the circuit breaker back on.

Turn the oven switch or your control panel in

position  in order to check whether the oven lighting is working properly.

Aftersales service

Our after-sales service is there for you if your appliance needs to be repaired. You will find the address and telephone number of your nearest after-sales service centre in the phone book. The after-sales service centres listed will also be happy to give you the details of an after-sales service point near you.

SN number

Please quote the SN number of the appliance when contacting the after-sales service. These numbers can be found on the rear backboard.

So you do not have to spend time looking for it if there is a fault, you can enter the data for your appliance here now.

SN no.

After-sales service

Tips and tricks

The following are tips and tricks to help you when cooking food in your appliance.

Tips for saving energy

Here are a few tips for saving energy when using the hob and oven.

Tips on using the hob

Suitable cookware diameter

Make sure that the diameter of the cookware is suitable for the diameter of whichever hotplate you are using.

You can find an overview of suitable diameters in the section entitled **Your new appliance - the hob**

Cookware with lids

Use cookware with a flat bottom.

If possible, use cookware with lids to save gas.

Less water

To reduce the cooking time for e.g. vegetables and potatoes, use less water.

Tips on using the oven

Several cakes

It is best to bake several cakes one after the other. The oven is still warm. This reduces the baking time for the second cake. You can also place two cake tins next to each other.

Using residual heat

Where longer cooking times are used, you can switch the oven off 10 minutes before the end of the cooking time and use the residual heat to finish cooking.

Closing the appliance door

Always keep the appliance door closed when it is in operation. If you need to open the appliance door, close it again as soon as possible. Otherwise, the temperature will drop and the oven will need to heat itself up again.

Tips for using your appliance

The following tips relate to ovenware and cooking and explain what to do if something goes wrong.

General tips

Since a lower temperature allows more even browning.

Clean the appliance and accessories after each use, once they have cooled down.

Always place baking tins or ovenware in the centre of the wire rack.

Always place cookware in the middle of the hotplate on the hob.

Boiling and frying

Cookware

For dishes which require a lot of liquid, use deep-sided pots so that they do not boil over.

The pan base must be clean, dry and flat.

Baking tips

How to confirm whether your sponge cake is cooked through.	Approximately 10 minutes before the end of the baking time stated in the recipe, pierce the highest point of the cake with a wooden skewer. If no cake mixture sticks to the wood, the cake is ready.
The cake collapses.	Next time, use less liquid or bake at a slightly lower temperature. Note the stirring times indicated in the recipe.
The cake has risen high in the middle and less around the edges.	Do not grease the edges of the baking tin. After baking, carefully loosen the cake using a knife.
The cake is too dark on the top.	Place the cake lower in the oven and bake at a lower temperature for slightly longer.
The cake is too dry.	Make tiny holes in the finished cake using a cocktail stick. Then pour fruit juice or an alcoholic drink over the cake. Next time, bake at a slightly higher temperature for less time.
The bread or cake looks good but it is streaked with water inside.	Next time, use less liquid and bake at a lower temperature for slightly longer. For cakes with a moist topping: Pre-bake the base first. Sprinkle the base with almonds and breadcrumbs and then pour the topping on. Take care to follow recipes and baking times.
The pastries are not evenly browned.	Set the temperature slightly lower. Excess greaseproof paper can affect the air circulation. Always cut the greaseproof paper down to the size of the baking tray.

Tips on using the rotary spit

Place the joint as centrally as possible on the rotary spit and secure it at both ends with the retaining clips.

You can also truss the joint with string. With poultry, bind the ends of the wings underneath the back and the thighs against the body. This will prevent them from becoming too dark. Pierce the skin on the underside of the wings to allow the fat to escape.

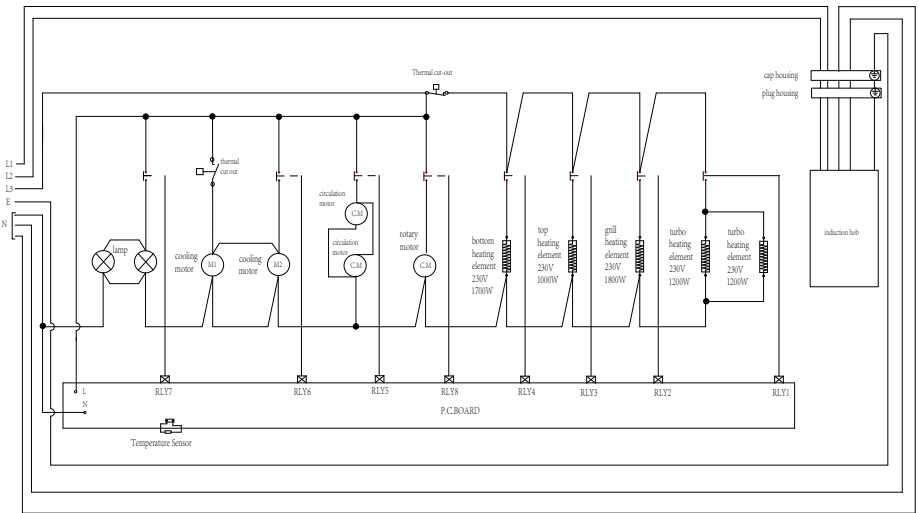
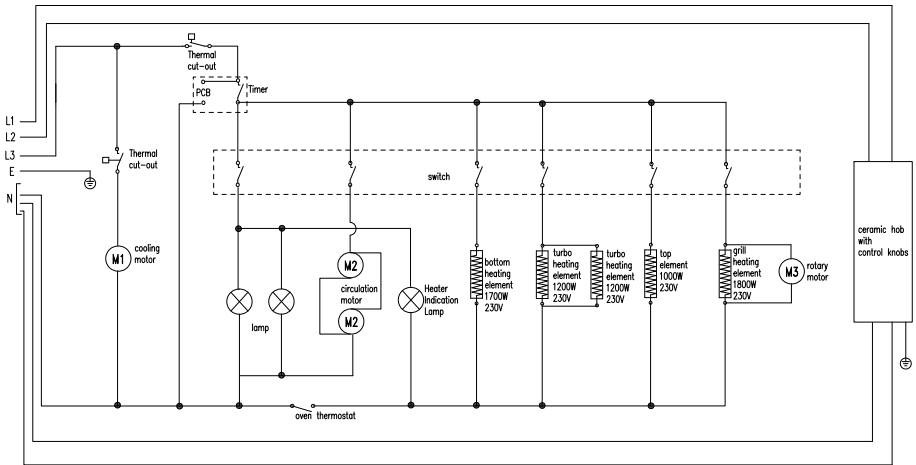



Pronto Service + Support: 1800 440 335
Email: service@eurostylegroup.com.au

HEAD OFFICE
65 Glynburn Road, Glyne SA 5070
Ph: 08 8165 1012

www.euroappliances.com.au

