

# Z337 SPEAKER SYSTEM WITH *BLUETOOTH*<sup>®</sup>

Complete Setup Guide  
完整设置指南

完整設定指南  
설치 가이드

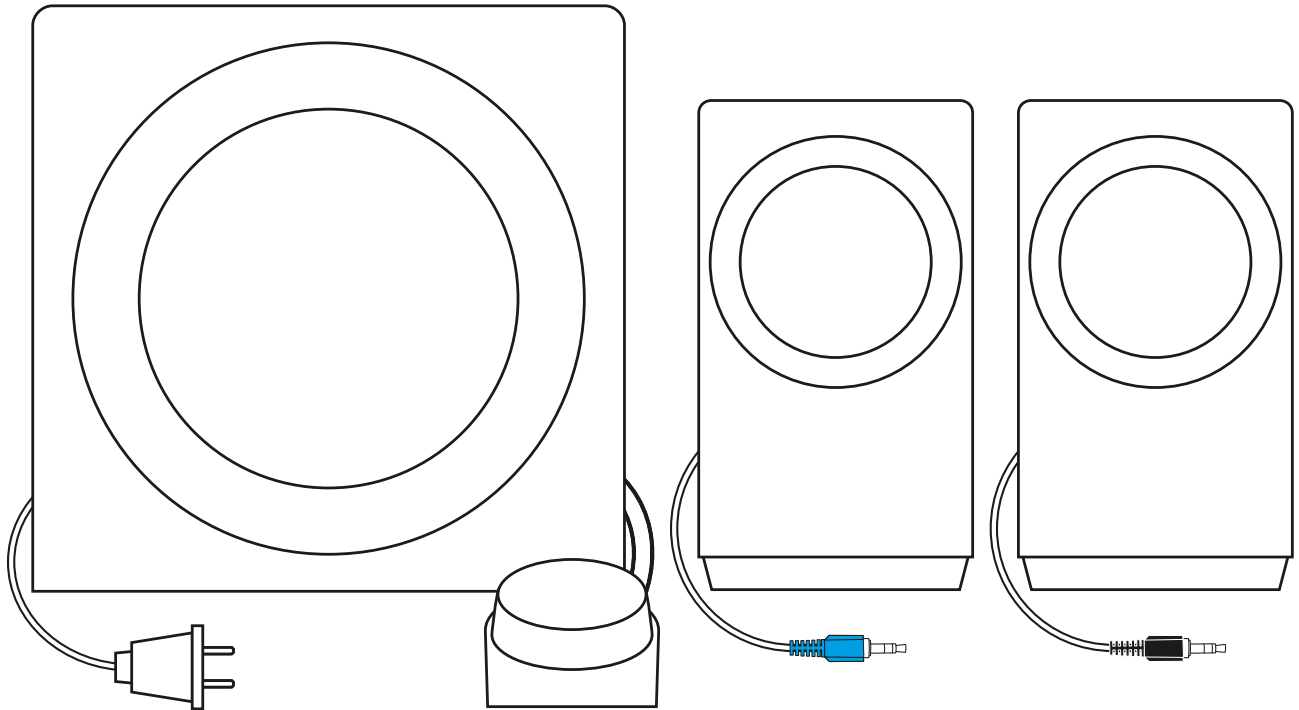

logitech<sup>®</sup>

## CONTENTS

English . . . . .3

简体中文 . . . . .9

繁體中文 . . . . . 15

한국어 . . . . . 21

# KNOW YOUR PRODUCT

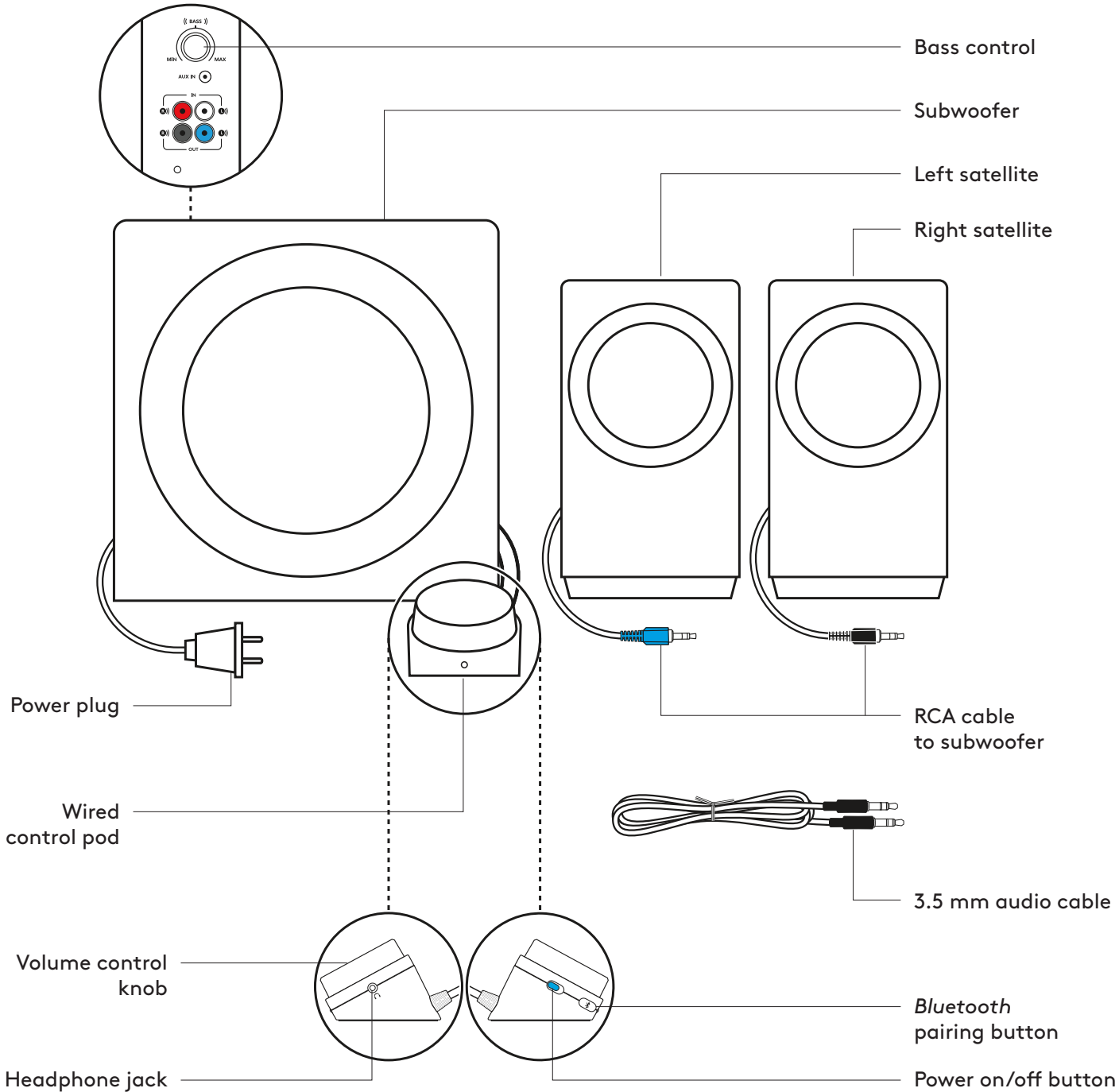

## CONNECT THE SPEAKERS

1. Plug the blue RCA connector on the left satellite into the blue subwoofer jack.
2. Plug the black RCA connector on the right satellite into the black subwoofer jack.
3. Plug the power plug into an electrical outlet.

1

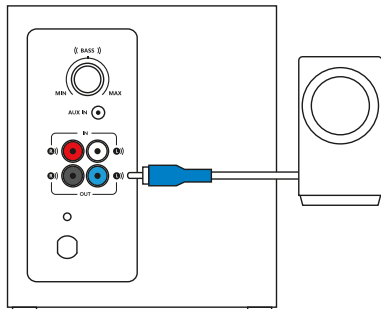

2

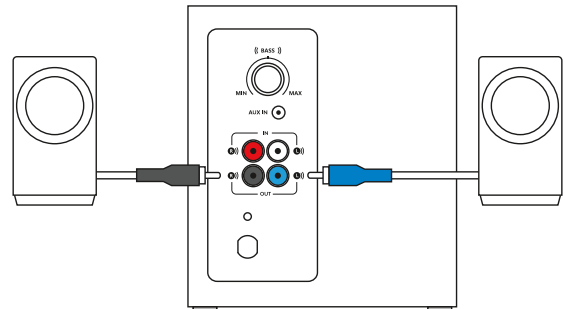

3

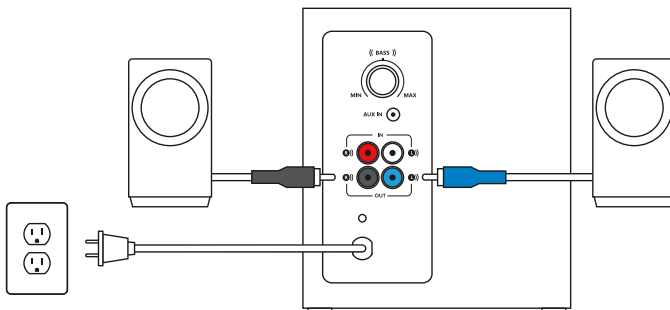

## CONNECT TO AUDIO SOURCE

Using *Bluetooth*®:

1. Turn on *Bluetooth* on your device.
2. Turn the speakers on.
3. Press and hold the *Bluetooth* button to activate pairing mode. The LED on the control pod will blink quickly.
4. Select and connect to “Logitech Z337” on your *Bluetooth* device list.
5. To pair with your second device via *Bluetooth*, repeat step 3 and step 4. Make sure to turn on *Bluetooth* on your device.

1

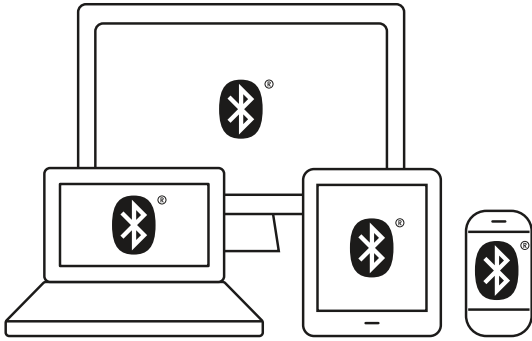

2

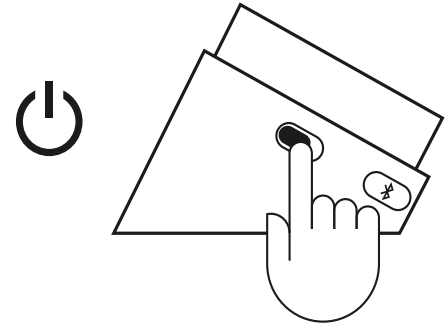

3

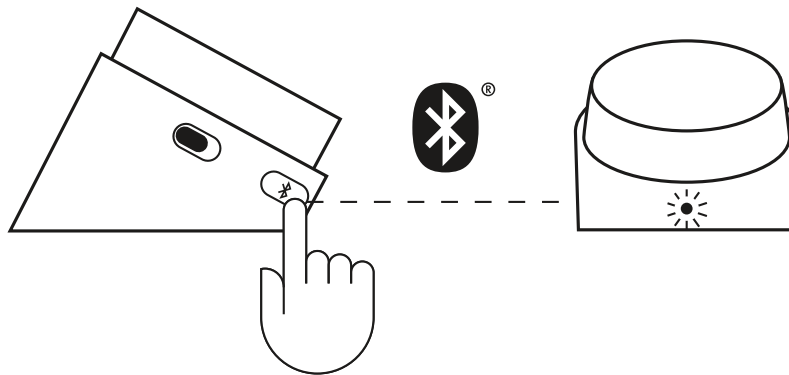

4

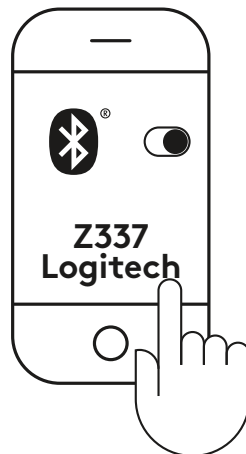

## CONNECT TO AUDIO SOURCE (CONT'D)

1A. For RCA connection:

Connect one end of the RCA cable to the corresponding RCA jack on the back of the subwoofer. Then connect the other end of the cable to the RCA outlet on your device (TV and gaming console, etc.).

Note: the RCA cable is not included in the box and must be purchased separately.

1B. For 3.5 mm connection:

Connect one end of the provided 3.5 mm cable to the auxiliary input on the back of the subwoofer. Then connect the other end of the cable to the 3.5 mm audio jack on your device.

2. Plug your headphones into the headphone jack on the control pod. Adjust the volume either from the control pod or the audio source.

3. Power speakers on/off by sliding the power on/off button on the wired control pod.

# 1A

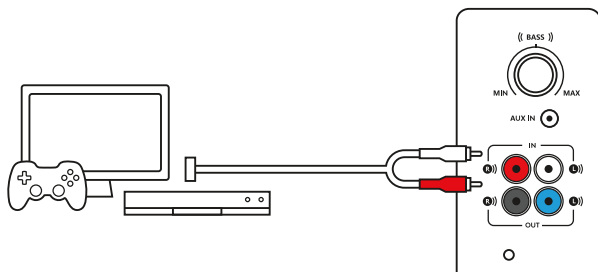

# 1B

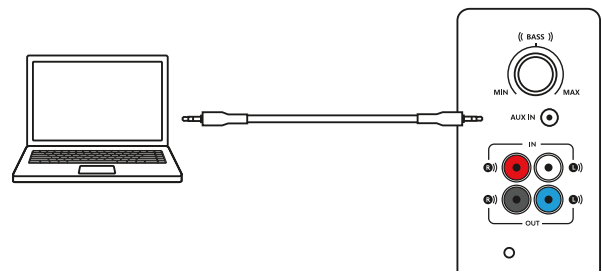

# 2

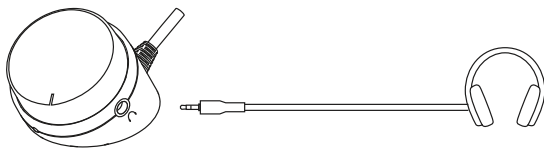

# 3

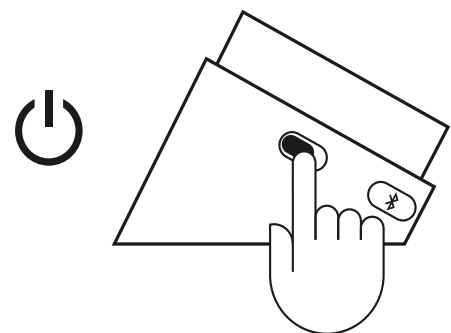

## CONNECT TO THREE DEVICES SIMULTANEOUSLY

1. Connect up to three devices at the same time through the RCA connector on the back of the subwoofer, the 3.5mm cable on the subwoofer and *Bluetooth*.
2. You can pair up to eight *Bluetooth* source devices with your speakers and connect to 2 of them at once.
3. To switch between audio sources just pause audio on one connected device and play audio from the other connected device.

1

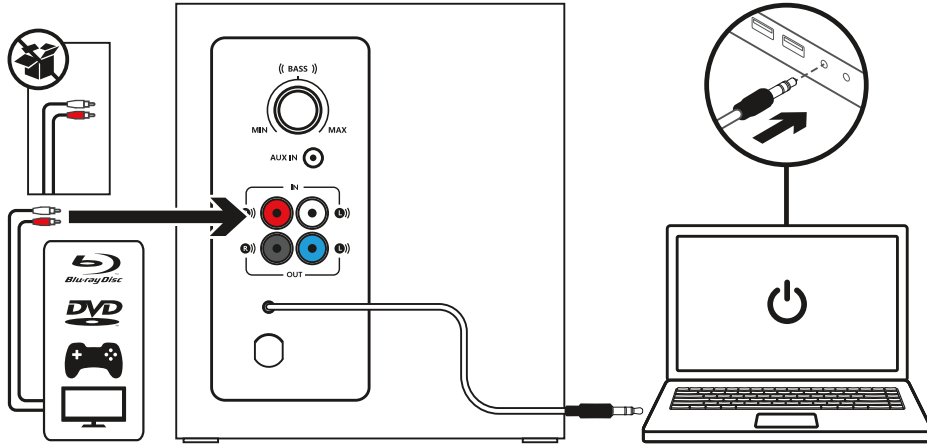

2

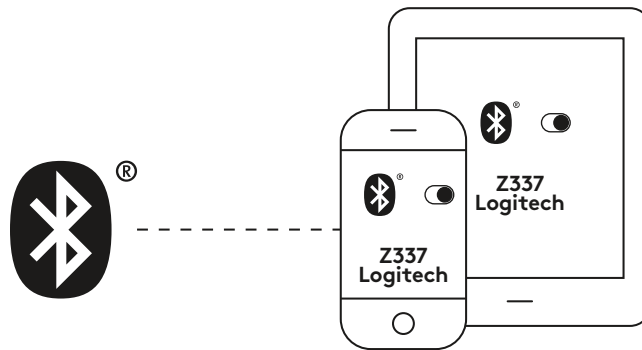

3

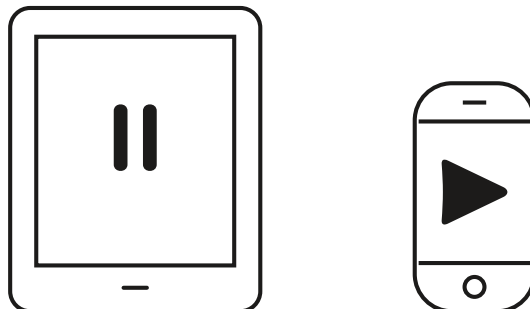

## ADJUST THE VOLUME

1. Adjust the volume of Z337 with the knob on the control pod.  
Turn the knob clockwise (to the right) to increase volume.  
Turn the knob counter-clockwise (to the left) to decrease volume.

## ADJUST THE BASS

2. Adjust the bass level by turning the bass control knob located at the back of your subwoofer.  
Turn bass knob to the right for deeper bass or to the left for less bass.

1

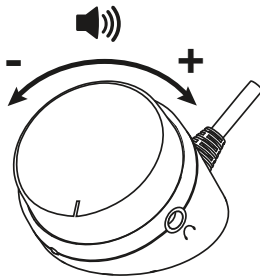

2

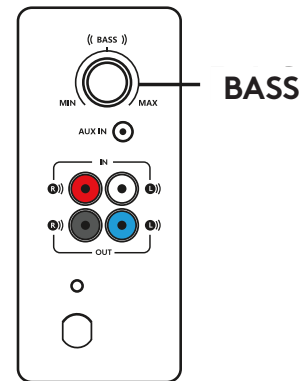

[www.logitech.com/support/Z337](http://www.logitech.com/support/Z337)

# 了解您的产品

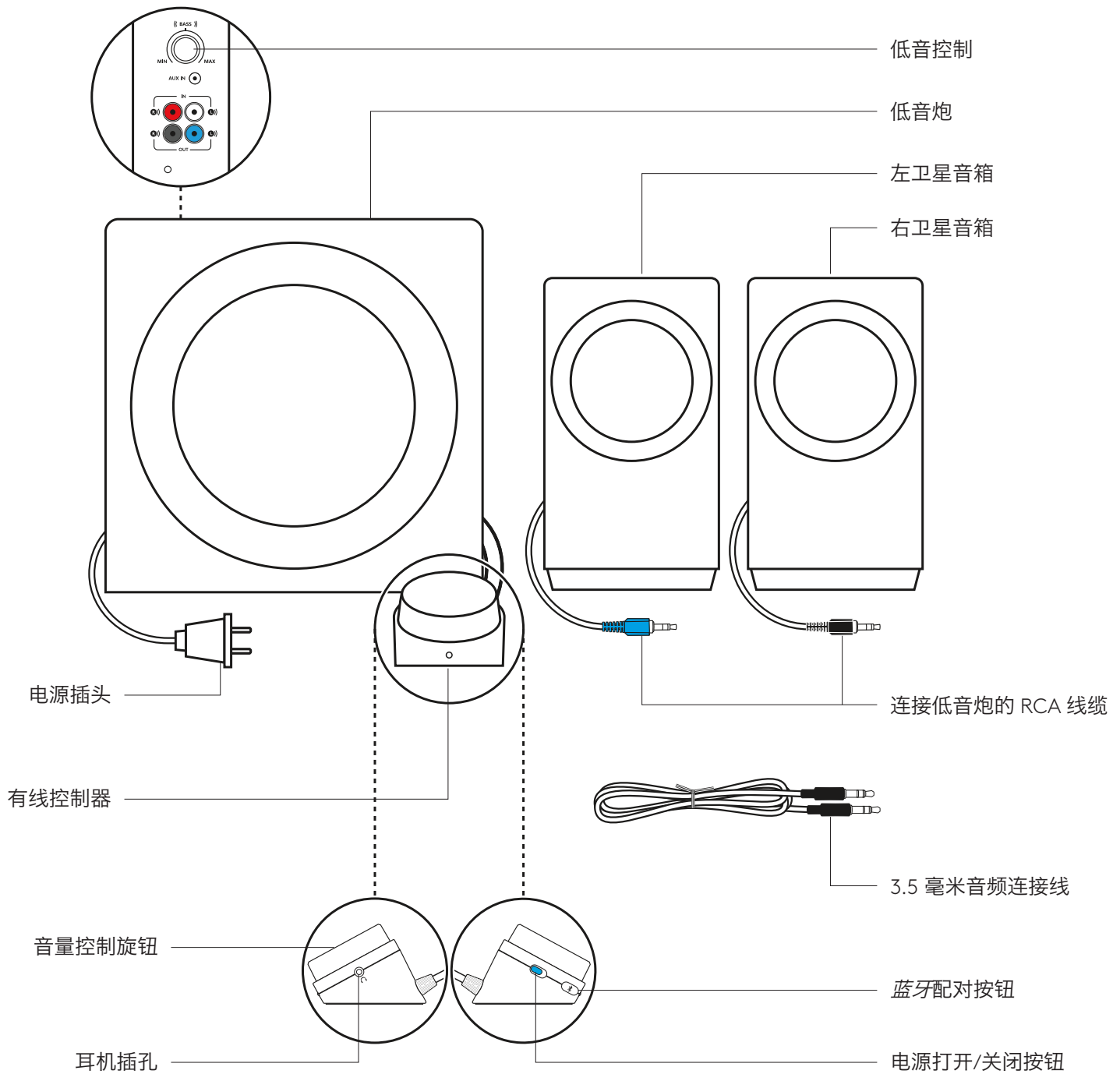

## 连接音箱

1. 将左侧卫星音箱上的蓝色 VGA 插头插入蓝色低音炮端口。
2. 将右侧卫星音箱上的黑色 VGA 插头插入黑色低音炮端口。
3. 将电源线插入电源插座。

1

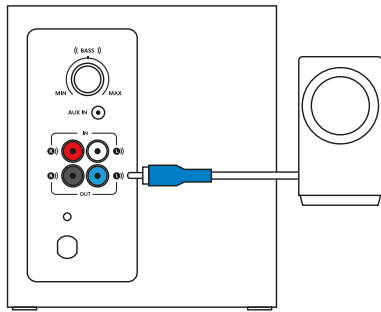

2

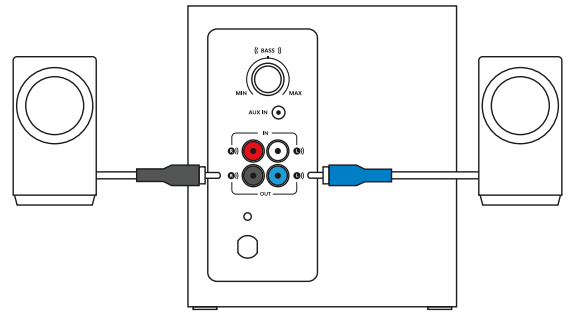

3

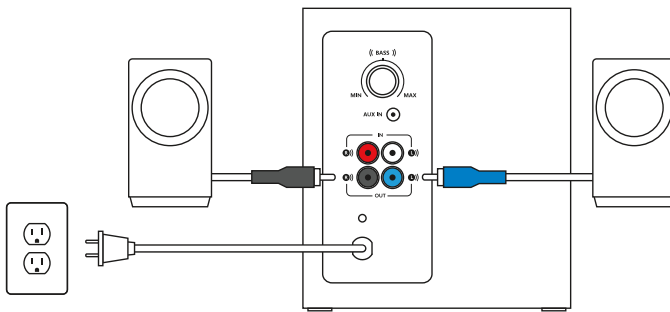

## 连接音源

使用蓝牙™：

1. 在设备上开启蓝牙。
2. 打开音箱。
3. 按住 蓝牙按钮激活配对模式。控制器的 LED 指示灯将快速闪烁。
4. 在设备的蓝牙设备列表中选择“罗技 Z337”。
5. 要通过 蓝牙与第二台设备配对，请重复步骤 3 和步骤 4。请确保已在设备上开启蓝牙。

1

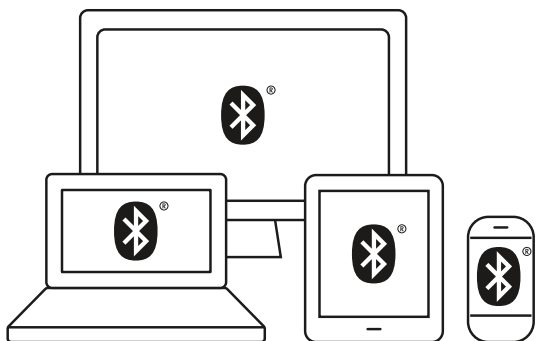

2

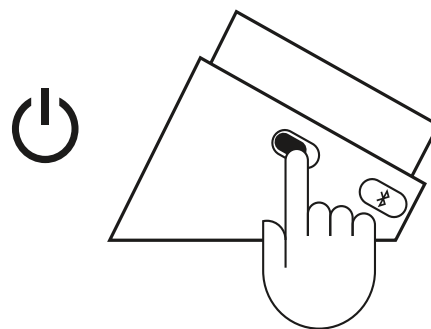

3

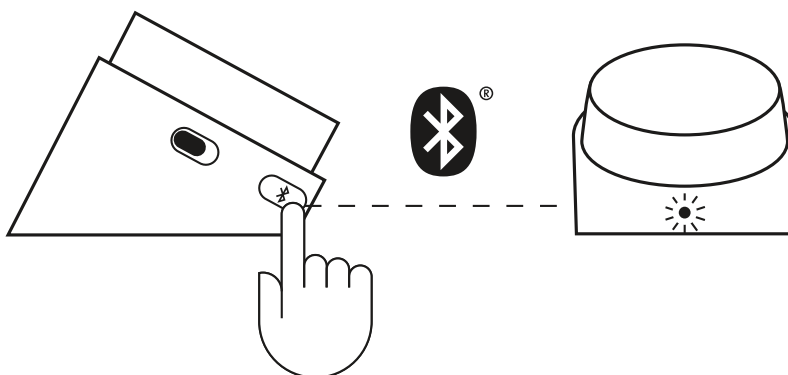

4

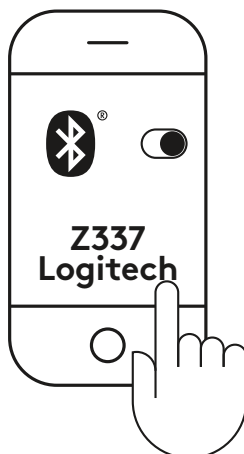

## 连接音源 (续)

### 1A.RCA 连接:

将 RCA 线缆的一端连接到低音炮背面的相应 RCA 插孔。将线缆的另一端连接设备的 RCA 插孔 (电视和游戏主机等)

注: RCA 线缆未随附, 需另购。

### 1B.3.5 毫米连接:

将随附的 3.5 毫米线缆的一端连接到低音炮背面的辅助输入。随后将线缆的另一端连接至设备的 3.5 毫米音频插孔。

2. 将耳机插入控制器上的耳机插孔。通过控制器或音源调节音量。
3. 滑动有线控制器上的电源开关按钮打开或关闭音箱。

# 1A

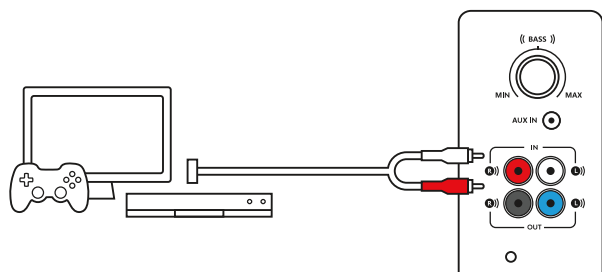

# 1B

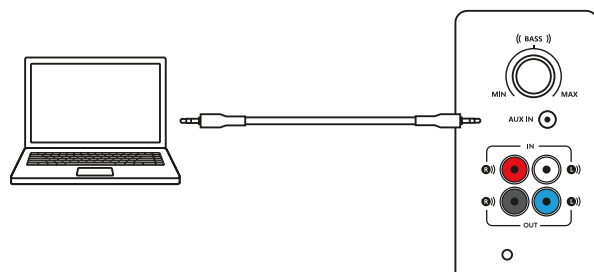

# 2

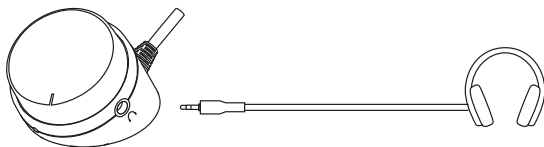

# 3

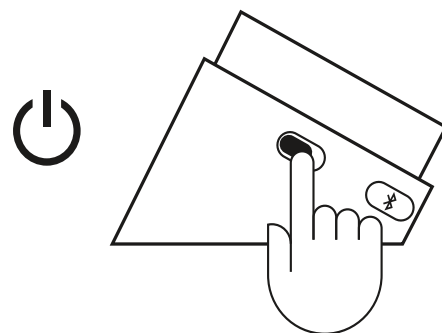

### 可同时连接三台设备

1. 通过低音炮背面的 RCA 端口和低音炮上的 3.5 毫米线缆以及蓝牙同时连接多达三个设备。
2. 最多可将八个蓝牙音源设备与音箱配对, 并且可同时连接 2 个音源设备。
3. 要在音源之间切换, 只需暂停一台连接设备上的音频, 然后播放来自其他连接设备的音频。

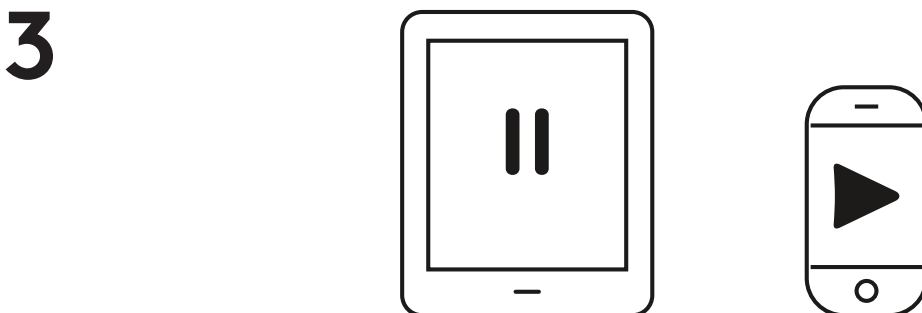
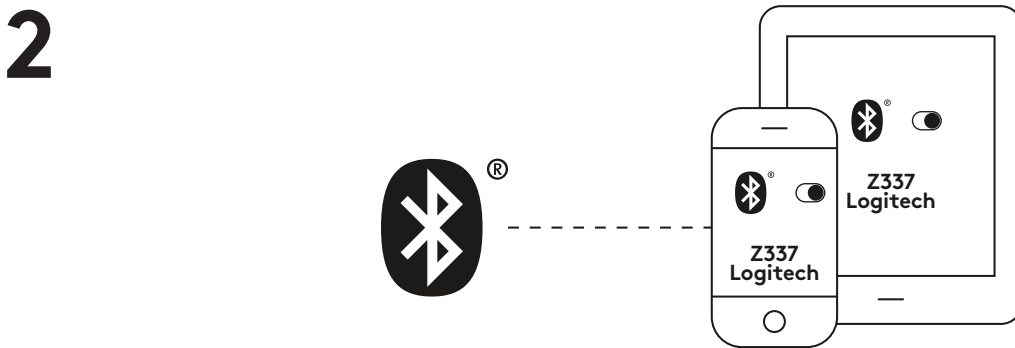
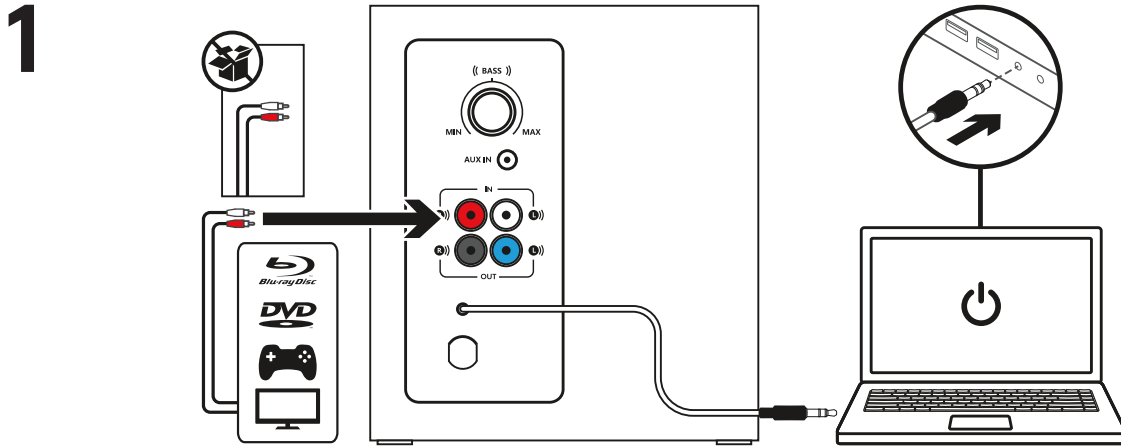

## 调节音量

1. 使用控制器旋钮调节 Z337 音量。  
顺时针（向右）旋转旋钮可提高音量。  
逆时针（向左）旋转旋钮可降低音量。

## 调节低音

2. 使用低音炮背面的低音控制旋钮可调节低音量。  
将低音旋钮向右旋转可获得更低沉的低音，向左旋转可获得较少的低音。

1

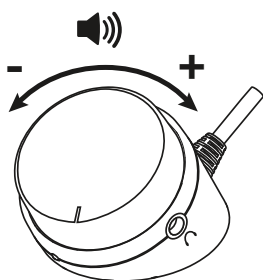

2

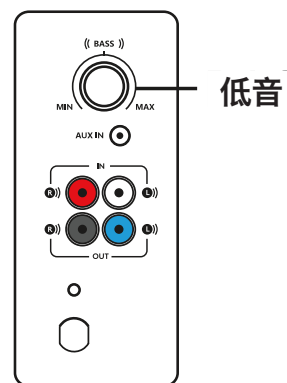

[www.logitech.com/support/Z337](http://www.logitech.com/support/Z337)

# 瞭解您的產品

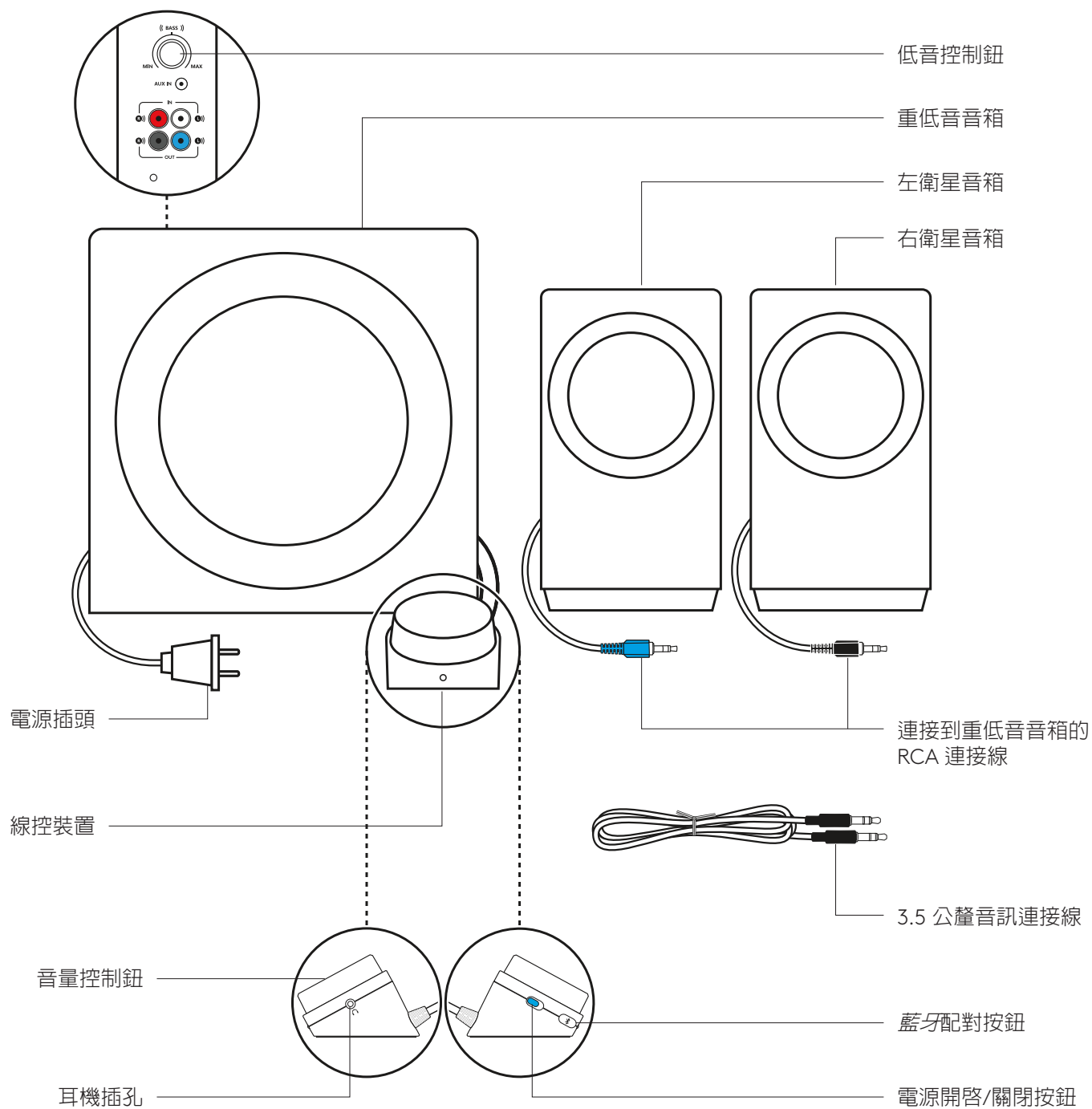

## 連接音箱

1. 將右衛星音箱的藍色 RCA 接頭插入到藍色重低音音箱插孔。
2. 將右衛星音箱的黑色 RCA 接頭插入到黑色重低音音箱插孔。
3. 將電源插頭插入到電氣插座。

1

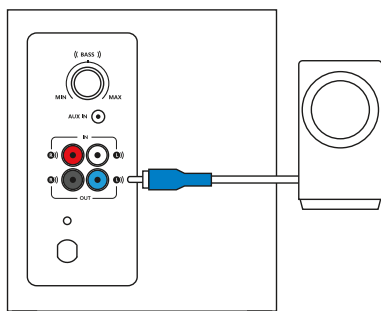

2

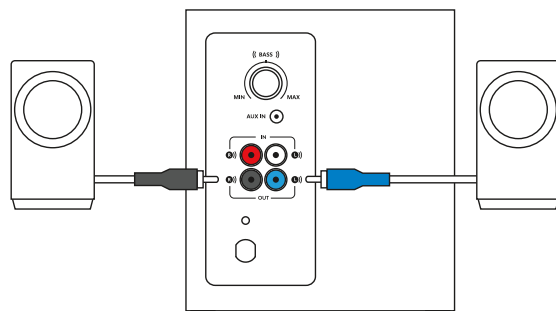

3

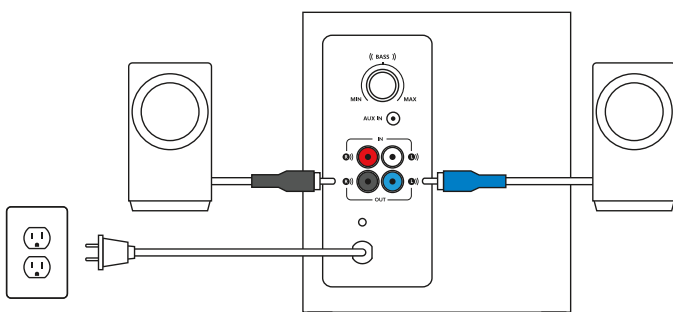

## 連接到音訊來源

使用藍牙：

1. 開啓裝置上的藍牙功能。
2. 開啓音箱電源。
3. 按住藍牙按鈕不放以啓動配對模式。線控裝置上 LED 指示燈會快速閃爍。
4. 在您的藍牙裝置清單中，選擇並連線到「羅技 Z337」。
5. 若要與您的第二個裝置透過藍牙配對，請重複步驟 3 和步驟 4。確認您的裝置已開啓藍牙功能。

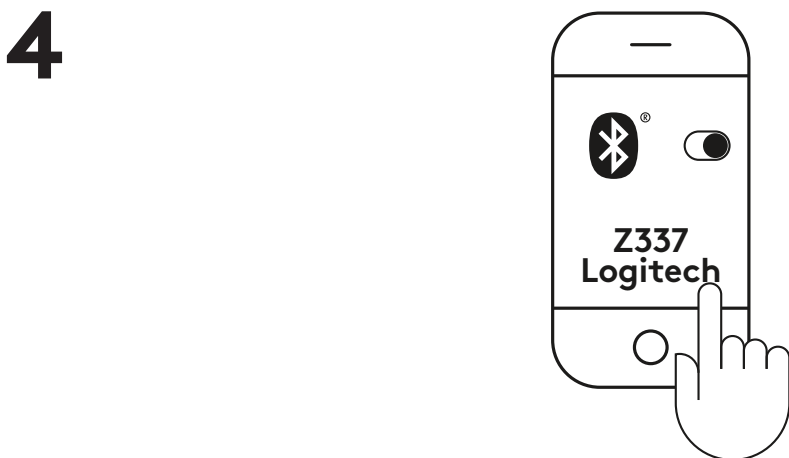
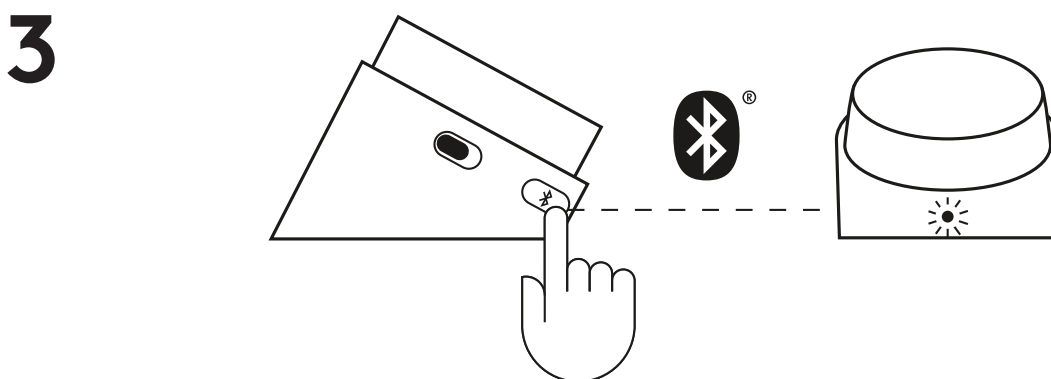
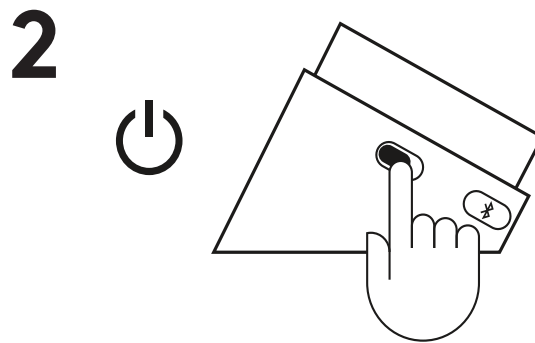
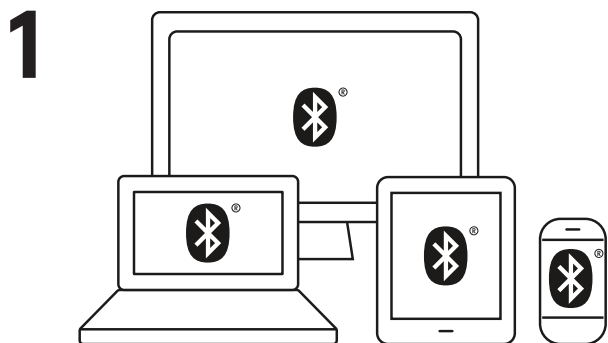

## 連接到音訊來源 (續)

### 1A.RCA 連接：

將 RCA 連接線的一端連接到相應的重低音音箱上相應的 RCA 插孔。將連接線的另一端，連接到裝置 (電視、遊戲主機等) 上的 RCA 插孔。

注意：包裝盒內未隨附 RCA 連接線，需另購。

### 1B.3.5 公釐連接：

將隨附的 3.5 公釐連接線的一端，連接到重低音音箱背面的輔助輸入埠。然後將連接線的另一端，連接到裝置上的 3.5 公釐音訊插孔。

2. 將耳機插入到線控裝置上的耳機插孔。利用線控裝置或音訊來源調整音量。

3. 撥動線控裝置上的電源開啓/關閉按鈕，開啓/關閉音箱電源。

# 1A

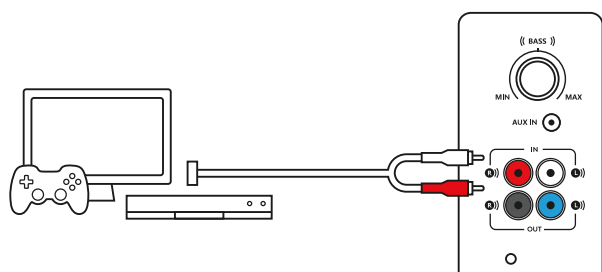

# 1B

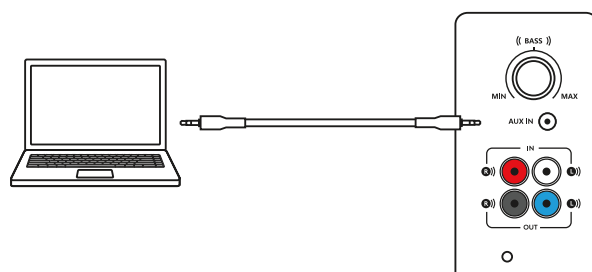

# 2

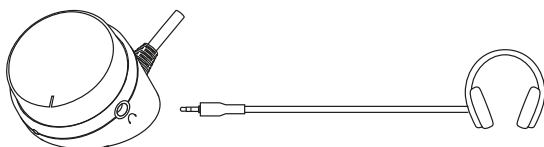

# 3

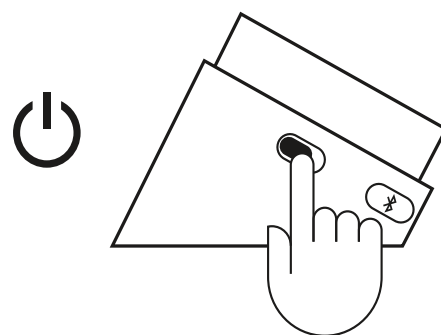

### 最多可同時連線三台裝置

1. 透過重低音音箱背面的 RCA 接頭和重低音音箱上的 3.5mm 連接線，以及藍牙功能，最多可同時連接到三個裝置。
2. 您最多可以將八個藍牙音源裝置與音箱建立配對，並同時連線到其中的 2 個裝置。
3. 若要切換音訊來源，只須暫停一個已連接之裝置上的音訊，然後從另一個已連接的裝置播放音訊。

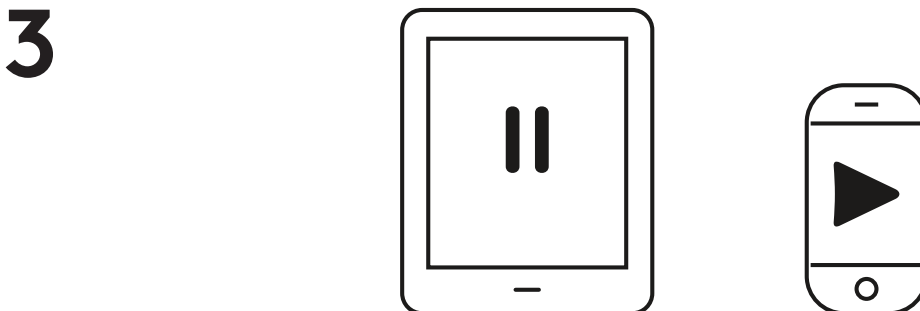
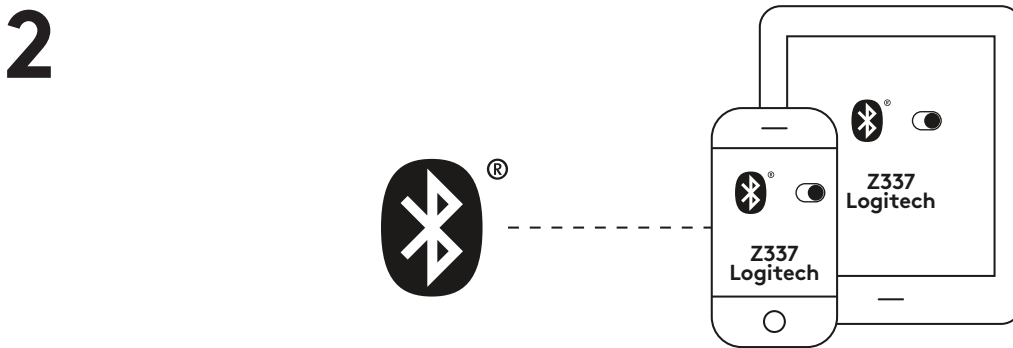
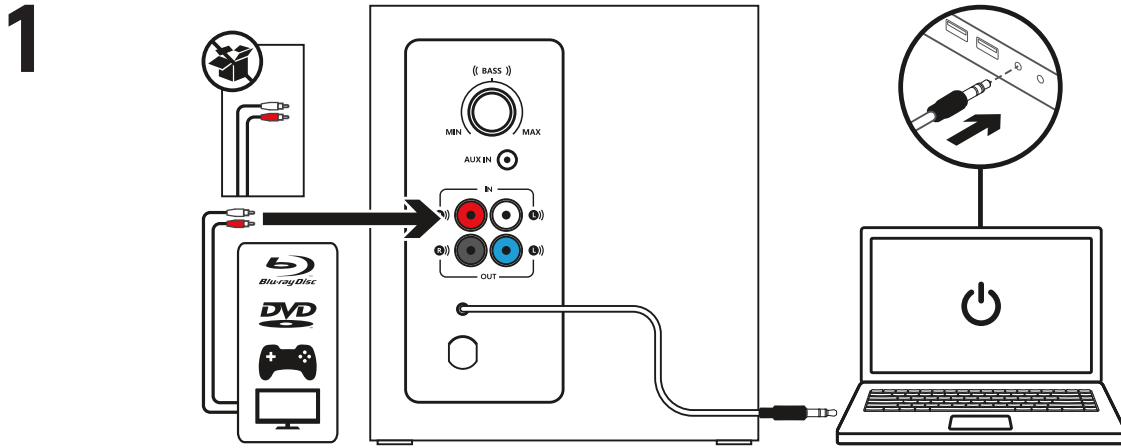

## 調整音量

1. 使用線控裝置上的控制鈕調整 Z337 的音量。  
順時針 (向右) 轉動轉鈕可增加音量。  
逆時針 (向左) 轉動轉鈕可減少音量。

## 調整低音

2. 使用重低音音箱背面的低音控制旋鈕可調整低音強度。  
向右轉動控制鈕可加強低音，向左轉動可減少低音。

1

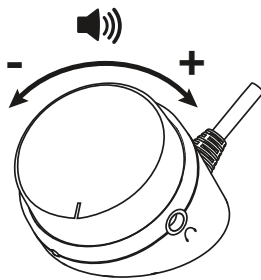

2

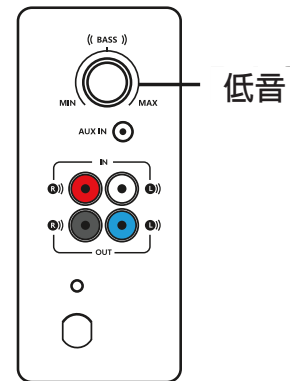

[www.logitech.com/support/Z337](http://www.logitech.com/support/Z337)

# 제품 설명

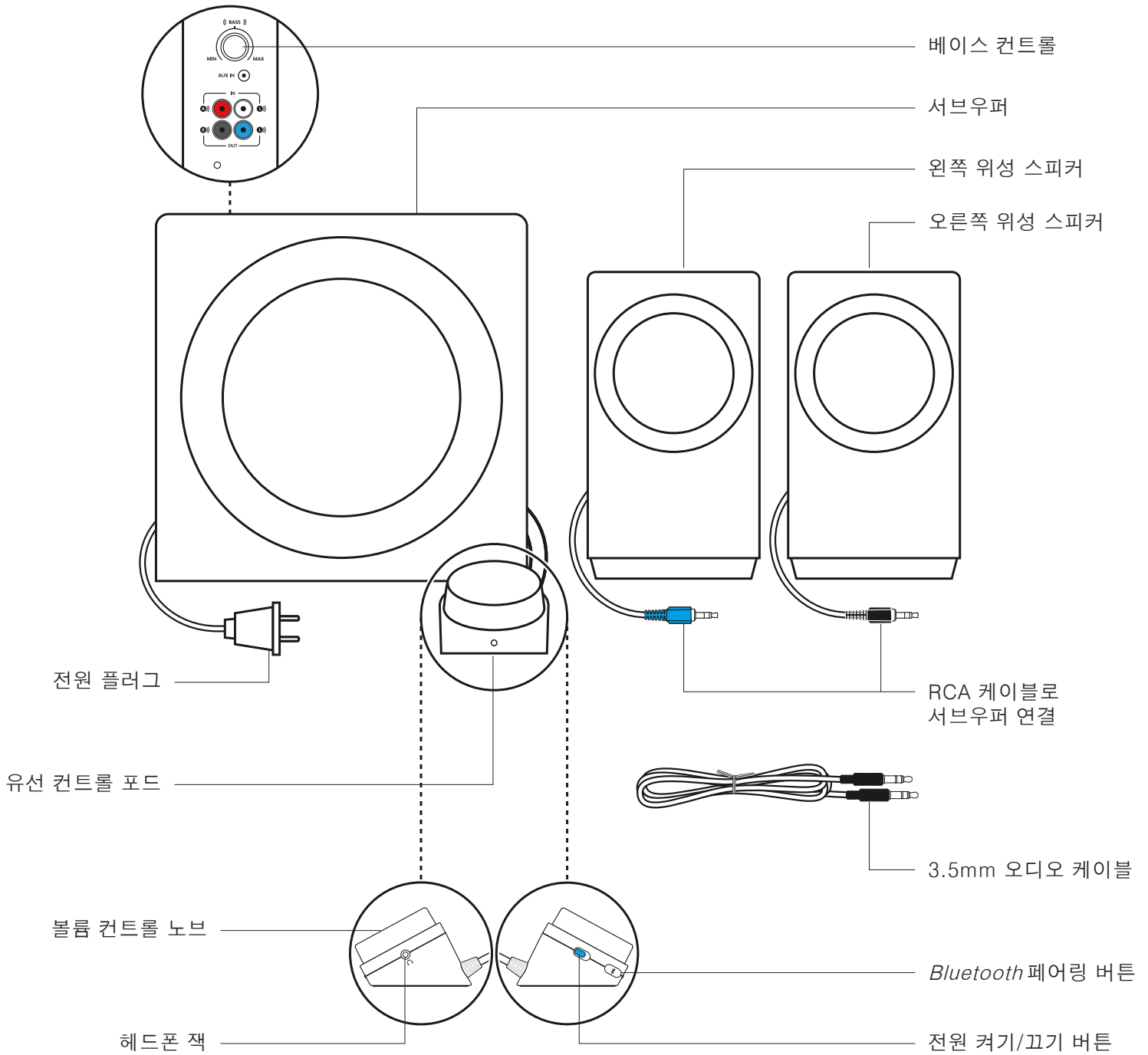

### 스피커 연결

1. 파란색 서브우퍼 잭에 좌측 스피커의 파란색 RCA 커넥터를 연결합니다.
2. 검은색 서브우퍼 잭에 우측 스피커의 검은색 RCA 커넥터를 연결합니다.
3. 전원 플러그를 전기 콘센트에 연결합니다.

1

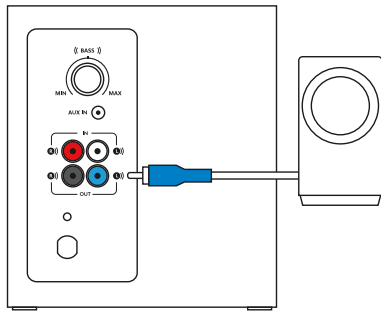

2

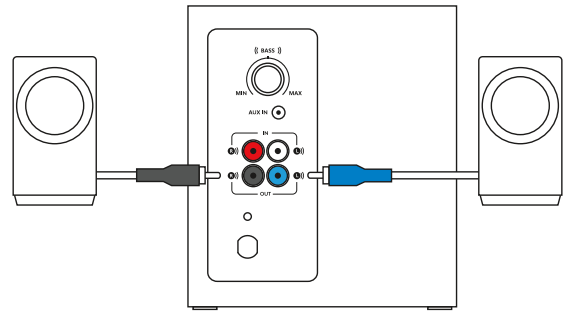

3

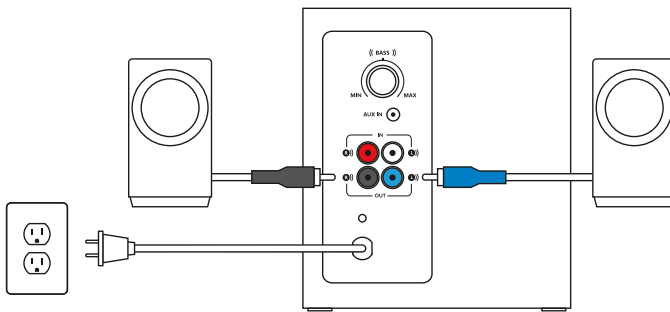

## 오디오 소스 연결

Bluetooth® 사용:

1. 장치에서 Bluetooth를 켭니다.
2. 스피커의 전원을 켭니다.
3. 페어링 모드를 활성화하려면 Bluetooth 버튼을 길게 누르십시오. 컨트롤 포드의 LED가 빠르게 깜박입니다.
4. Bluetooth 장치 목록에서 "로지텍 Z337"을 선택하고 연결하십시오.
5. Bluetooth를 통해 두 번째 기기와 페어링하려면 3단계와 4단계를 반복하십시오. 기기의 Bluetooth를 켜는지 확인하십시오.

1

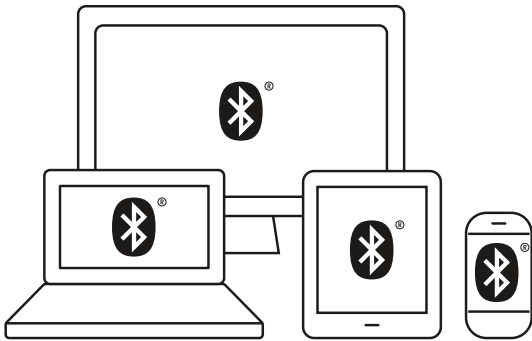

2

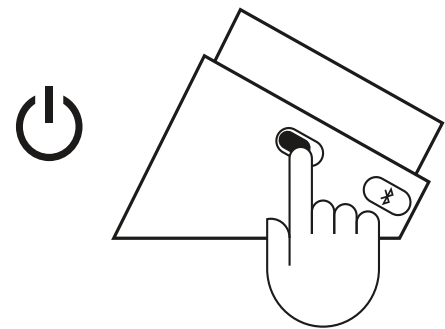

3

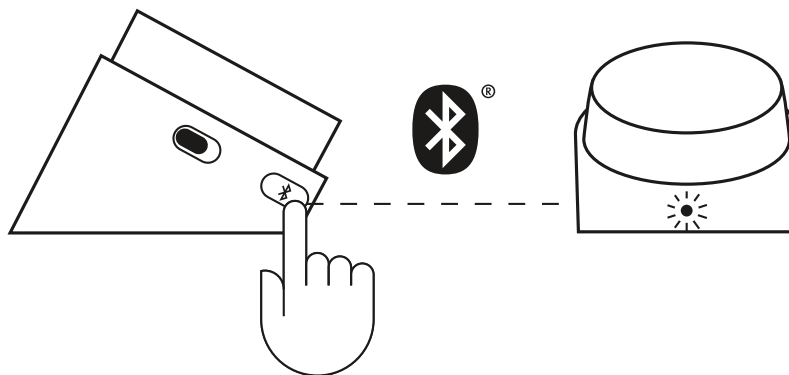

4

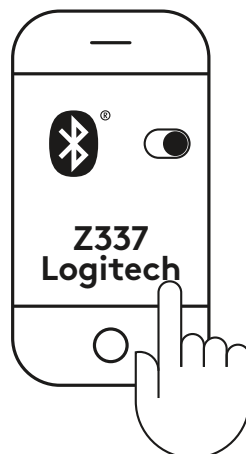

## 오디오 소스 연결(계속)

### 1A. RCA 연결의 경우:

RCA 케이블의 한쪽 끝을 서버우퍼의 뒤쪽에 있는 해당 RCA 잭에 연결하십시오. 그다음 케이블의 다른 쪽 끝을 장치의 RCA 콘센트에 연결하십시오(TV, 게임 콘솔 등).

참고: RCA 케이블은 박스에 포함되지 않으며 따로 구매하셔야 합니다.

### 1B. 3.5mm 연결의 경우:

제공된 3.5mm 케이블의 한 쪽 끝을 서버우퍼 뒷면에 있는 보조 입력에 연결합니다. 그다음 케이블의 다른 쪽 끝을 장치의 3.5mm 오디오 잭에 연결하십시오.

2. 컨트롤 포드의 헤드폰 잭에 헤드폰을 연결합니다. 컨트롤 포드 또는 오디오 소스에서 볼륨을 조절하십시오.
3. 유선 컨트롤 포드의 전원 켜기/끄기 버튼을 눌러 전원 스피커를 켜거나 끕니다.

# 1A

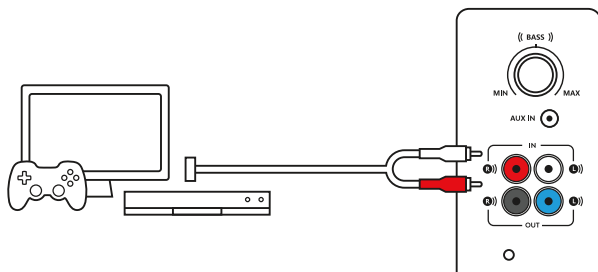

# 1B

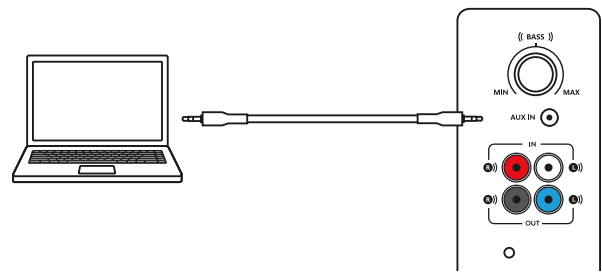

# 2

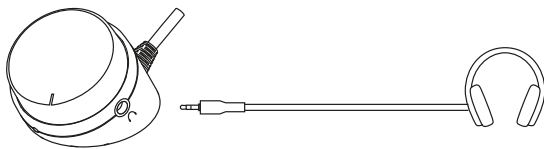

# 3

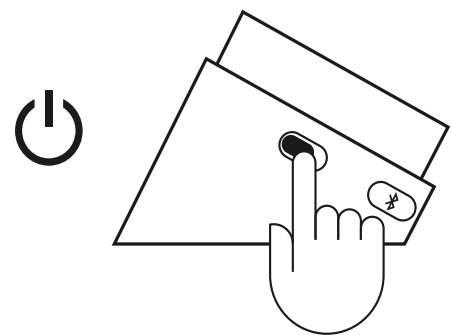

### 최대 3개 장치를 동시에 연결할 수 있습니다

1. 서브우퍼 뒷면의 RCA 커넥터와 서브우퍼의 3.5mm 케이블 및 Bluetooth로 최대 3개의 장치를 동시에 연결하십시오.
2. 최대 8개의 Bluetooth 소스 장치를 스피커와 페어링하며 그 중 2개를 동시에 연결할 수 있습니다.
3. 오디오 소스 사이를 전환하려면 연결된 장치 중 하나의 오디오를 일시 중지하고 연결된 다른 장치에서 오디오를 재생하십시오.

1

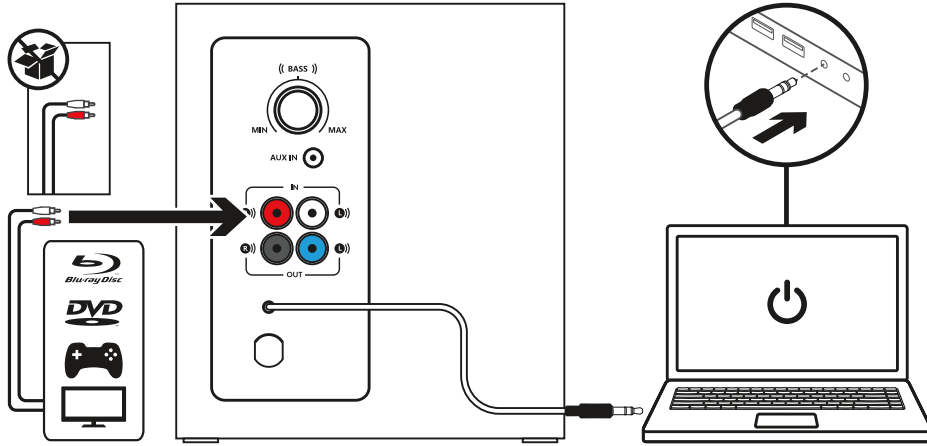

2

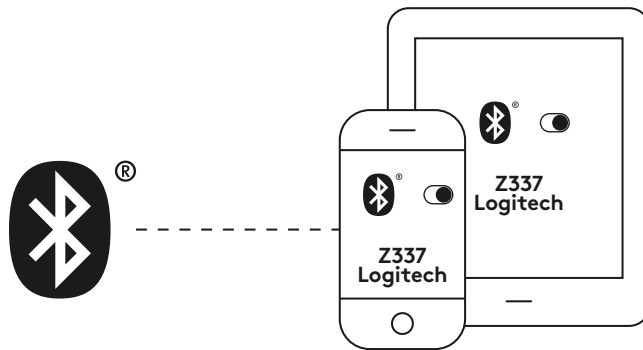

3

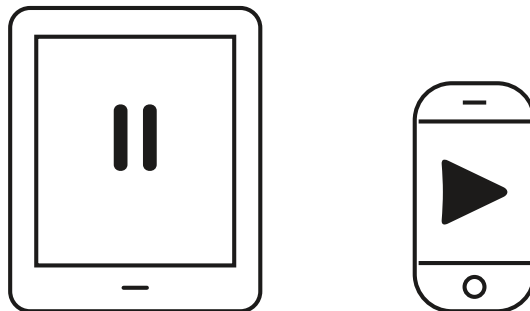

### 볼륨 조절

- 컨트롤 포드의 노브를 사용하여 Z337의 볼륨을 조절하십시오.  
볼륨을 높이려면 노브를 시계 방향(오른쪽)으로 돌리십시오.  
볼륨을 줄려면 노브를 시계 반대 방향(왼쪽)으로 돌리십시오.

### 베이스 조절

- 서브우퍼 뒷면에 있는 베이스 조절 노브를 사용하여 베이스를 조절합니다.  
베이스 노브를 오른쪽으로 돌리면 베이스가 깊어지며 왼쪽으로 돌리면 작아집니다.

1

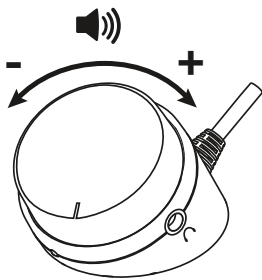

2

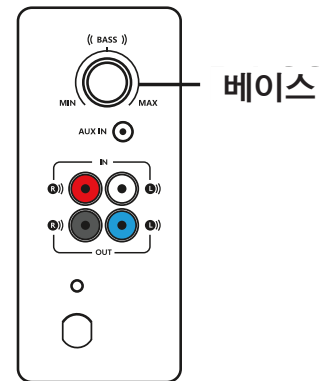

[www.logitech.com/support/Z337](http://www.logitech.com/support/Z337)

[www.logitech.com/support/Z337](http://www.logitech.com/support/Z337)

© 2019 Logitech. Logitech, Logi and other Logitech marks are owned by Logitech and may be registered. All other trademarks are the property of their respective owners. Logitech assumes no responsibility for any errors that may appear in this manual. Information contained herein is subject to change without notice.

WEB-621-001234.002

**logitech®**

