

clean+wash

Hygiene

Dyson Clean+Wash
Hygiene Logo.

User manual

Dyson Clean+Wash
Hygiene hard floor cleaner.

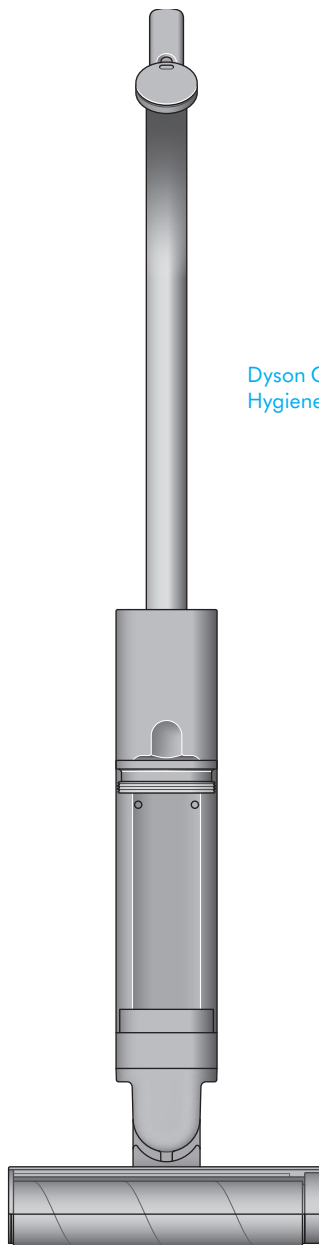

Contents

In the box

Download the MyDyson™ app

Getting started

The LCD screen

Quick start

How to clean

Self-cleaning and daily maintenance

Regular maintenance

Deep-clean maintenance

Battery and performance tips

Disassemble your machine

Troubleshooting

Support and service

dyson

Dyson logo

In the box

Your machine is boxed in two parts:

1. Machine body
2. Handle

Simply attach the handle to the main body.

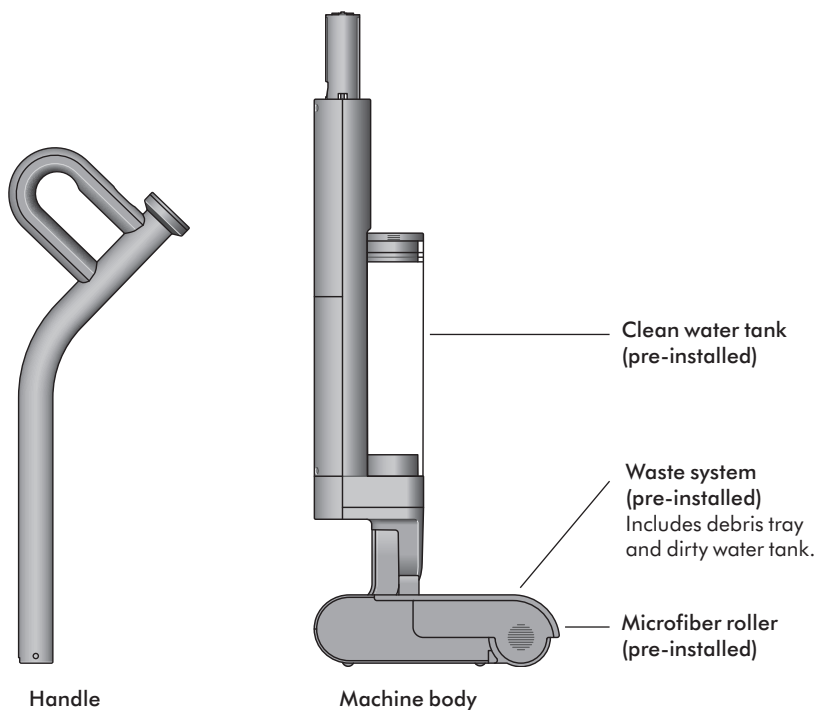

02 Probiotic cleaning solution

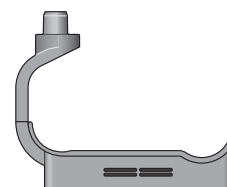

Hot-air drying dock

One-piece charging dock with plug. The Dyson Clean+Wash Hygiene Hot-air drying dock charges, cleans, and hot-air dries the machine on the dock.

Download the MyDyson™ app

Download the MyDyson™ app from the App Store or Google Play.
Open the app and follow the on-screen instructions to create a new account.



MyDyson logo.



[Download on the Apple App Store.](#)



[Get it on Google Play.](#)

Apple, the Apple logo, and Siri are trademarks of Apple Inc. App Store is a service mark of Apple Inc. Google Play, the Google Play logo, Google Assistant are trademarks of Google Inc.

Getting started

Get to know your machine's controls

Hydration modes

The Mode select button is located just below the LCD screen, below the screen is the MAX button and then the Power on/off button.

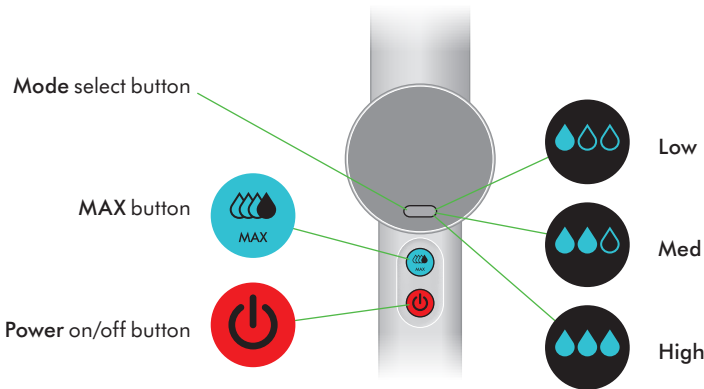

1. Click the wand into the main body until it locks in place.

The wand clicks into place above the main body of the machine.

2. Wake the machine by pressing any button. Press and hold the mode select button to set your desired language.

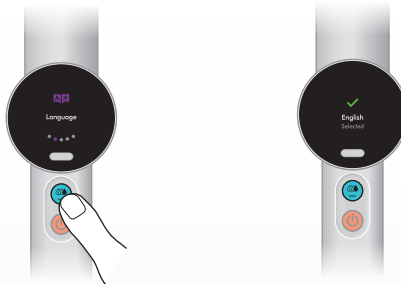

3. Download the MyDyson™ app from the App Store or Google Play via QR code shown on screen.



4. Register your machine using the serial number (located behind the battery pack).

5. Place your Clean+Wash Hygiene on the charging dock and fully charge before first use.

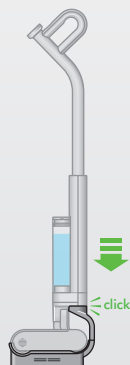

The Clean+Wash Hygiene stands upright in its dock.

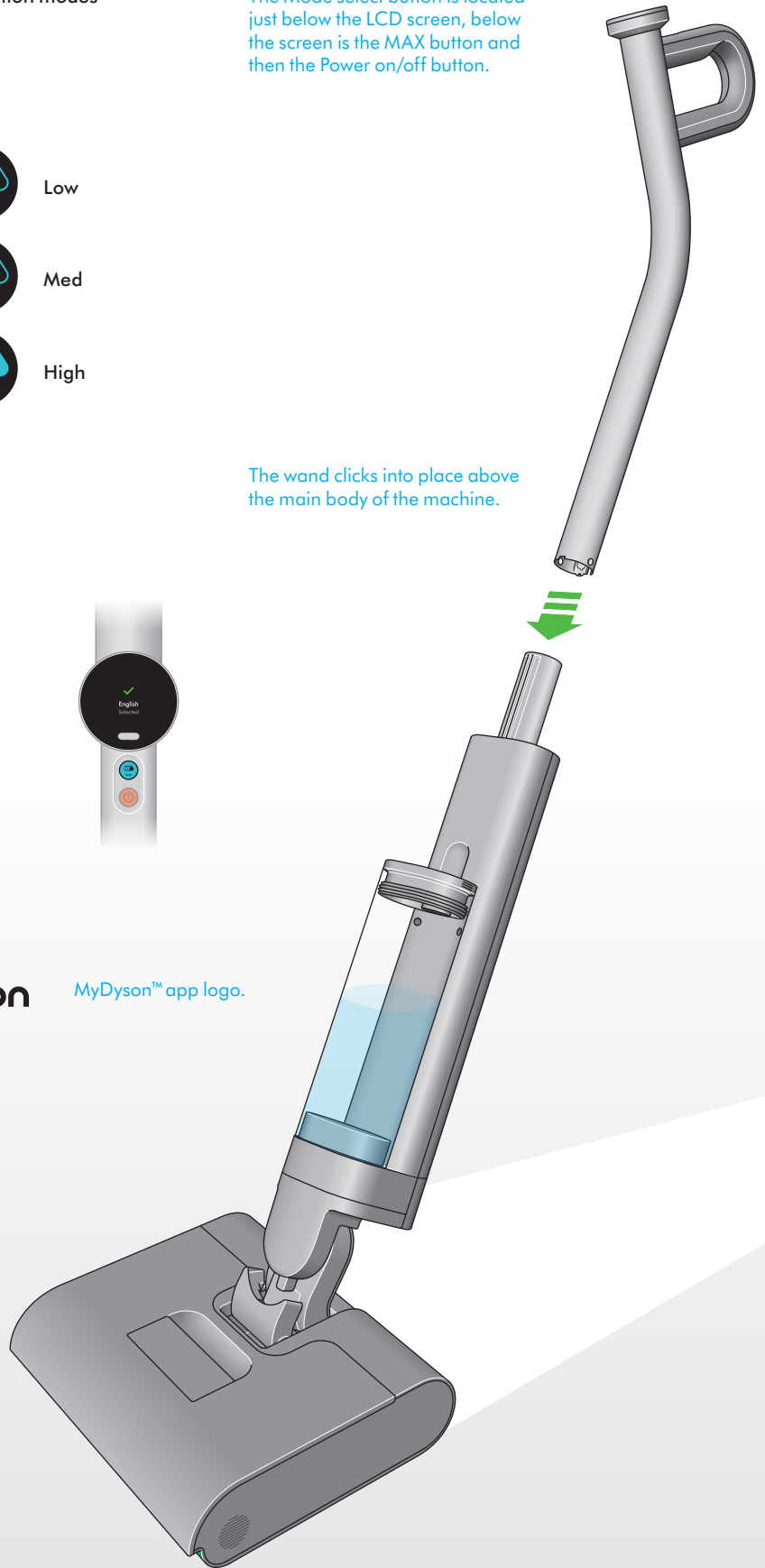

The LCD screen

The LCD screen displays helpful performance information such as the selected mode, remaining run time and essential maintenance alerts.

Cleaning

Use the Mode button to select mode. Press start to begin cleaning.

Choose the mode to suit the task

Water droplet icons indicate power modes: Low, Med, High, MAX.

Low mode (Least water applied)

For dust, hair and liquid spills

One filled water droplet shows your machine is in Low mode.



Med mode

For dry debris and thicker spills.

Two filled water droplets shows your machine is in Med mode.

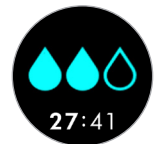

High mode

For oils, sticky spills and stains.

Three filled water droplets shows your machine is in High mode.

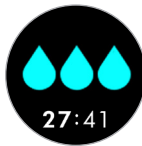

MAX mode (Most water applied)

Press and hold the MAX button for the most stubborn stains and dirt.

Tip: Use MAX sparingly to preserve battery life.

Four water droplets and text reading MAX shows your machine is in Max mode.



Alerts

Empty dirty water tank

When your dirty water tank is full, you will be prompted with an alert on the screen.

A caution sign with text reading: Empty dirty water tank.



Roller stuck

You will be prompted with this alert if something is stuck between the roller and the squeegee, or if your roller is not attached correctly.

A caution sign with text reading: Roller stuck.



Self-cleaning and Hot air drying

Self-cleaning in progress

Shows when self-clean is operating.

LCD screen shows the cleaner head with blue graphics representing self-cleaning.



Hot-air drying progress

Shows when hot-air drying is operating.

LCD screen shows the cleaner head with red graphics representing the hot-air drying.



Self-clean awaiting

When machine is below 30% battery, the self-clean cycle will be disabled. Place the machine on the dock to charge.

Roller icon with text reading: Paused.



Replacement rollers

We recommend replacing your microfiber roller at around 6 months, depending on usage. The machine will alert you when they need to be changed – and display a QR code for ordering replacements. When fitting a new roller, reset the lifetime counter.



Roller icon with text reading: Roller life, Caution sign with text reading: Replace roller, and a QR code.

Run time

The LCD screen constantly displays the machine's remaining run time underneath the water droplet icon – so you'll always know how much cleaning you have left.

Your Dyson Clean+Wash Hygiene hard floor cleaner runs on a battery with up to 45 minutes charge. Low battery alert will be shown when remaining run time is low.

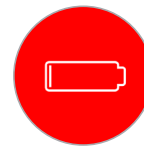

A caution sign with text reading: Low battery.

Quick start

Remove the clean water tank

Press the release button and lift the clean water tank away from the machine.

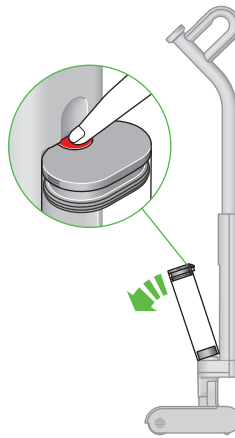

The release button is located on the top of the clean water tank.

Fill the clean water tank

Open the lid and fill to the MAX line with clean water, or just under if adding cleaning solution (Max 140°F).

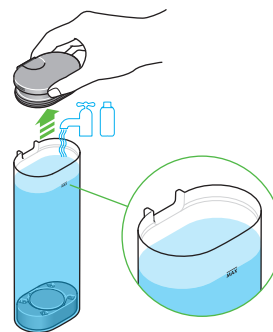

Add cleaning solution

Add 20ml of O2 Probiotic hard floor cleaner.



Dyson O2 Probiotic hard floor cleaning solution.

Close and replace the clean water tank

Close the lid and reconnect the tank to the body of the machine.



Allow roller to fully hydrate

For first use, allow 5 minutes for the roller to fully hydrate. For subsequent uses allow 10 seconds.

How to clean

Position your machine

Take the machine off the dock. Gently place your foot on the cleaner head and recline the handle until you hear a click.

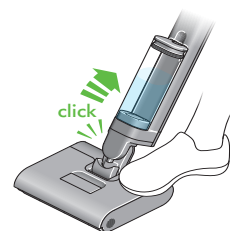
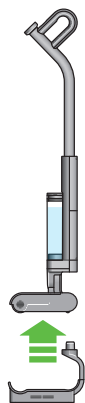

Selecting cleaning mode

Select the mode using the mode button.



The mode select button is located just below the LCD screen.

Starting the machine

Press the power button to start.



The power button is located below the MAX button, underneath the LCD screen.

Cleaning method

For maximum pickup, move the machine at a slow pace.

Tip: For best results, clean in overlapping passes.



Self-cleaning and daily maintenance

Recommended after every clean

Take your Clean+Wash Hygiene to where the waste will be disposed.

Remove the waste system

Gently lift the waste system from the cleaner head. Once removed, hold the system upright with the debris tray facing upwards, and dirty water tank below.

Lift using the red release handle on the top of the waste system.

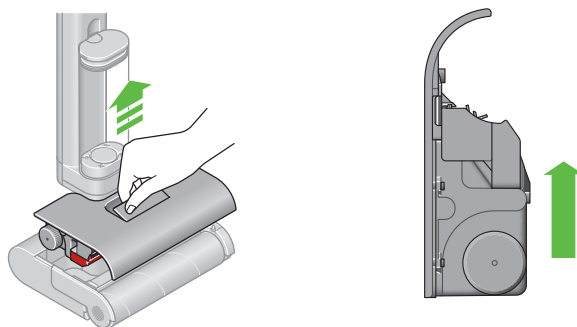

Dispose of dry debris

Pull the debris tray from the side of the system, and tap any debris into the bin.

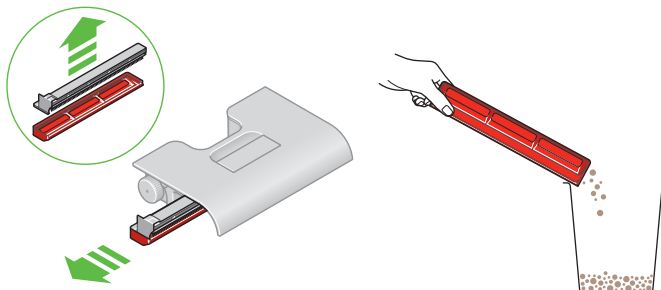

Clean the debris tray

Rinse the debris tray, anti-tangle comb and sprung mangle with clean running water.

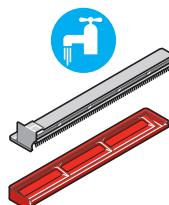

Empty and clean the dirty water tank

Dispose of dirty water from the dirty water tank and rinse with clean water.

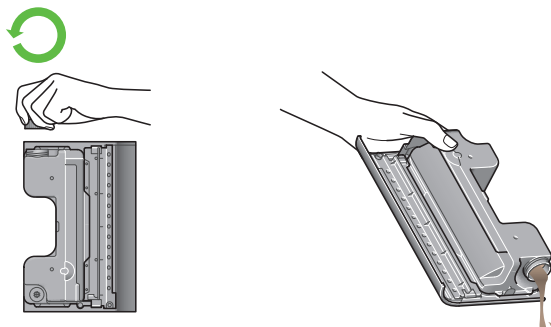

Unscrew the dirty water tank cap to empty.

Self-cleaning and daily maintenance

Recommended after every clean

Re-assemble the waste system

Place the debris tray back into the waste system, ensuring it is fitted all the way in.

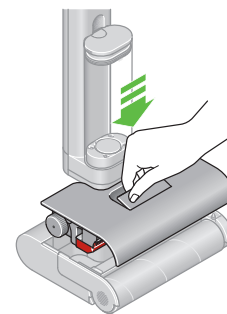
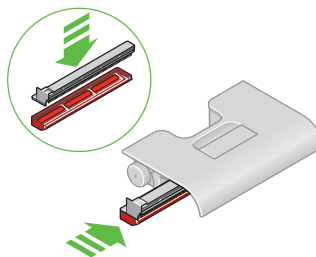

Replace the waste system

Slot the whole waste system back into the cleaner head. Ensure that it is fully locked into place by pressing firmly on the central red lever until you hear a loud click. Place the machine on the dock.

Setting up for self-clean

Fill the clean water tank to the MAX line or just under if adding solution which should be measured to 20ml.

The LCD menu will auto-prompt 'Self-Clean'. Follow the instructions and press the MAX button to start self-cleaning. If battery is below 30%, the LCD menu will alert 'Low Battery' and self-clean will be disabled until battery is charged to 30%.

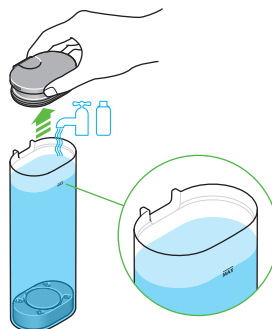

The MAX button is located just underneath the LCD screen.

Hot-air drying

The cleaning cycle runs for 145 seconds, flushing and refreshing the system.

Hot-air drying will automatically start after the self-clean cycle and will run for 30 mins.

After completion, empty the dirty water tank.

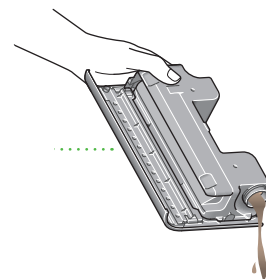
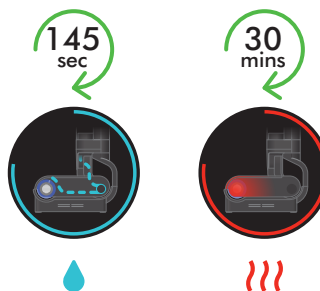

Regular maintenance

Recommended once every other week

Remove the roller

Unlock and remove the roller from the side of the cleaner head, detaching it from the motor component.

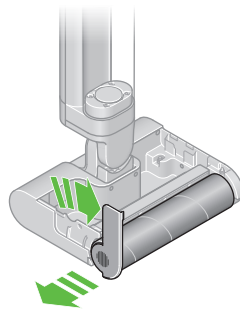

Lift the release lever on the side of the cleaner head to an upright position to allow the roller to be removed.

Wash the roller

Wash the roller in a sink, using warm water and gentle detergent. Squeeze to remove excess water and leave to dry.

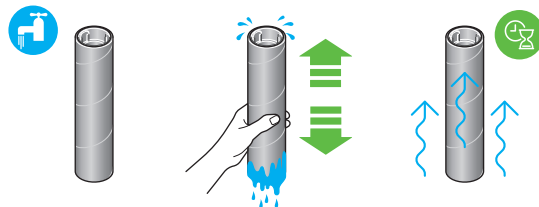

Clean the end cap and the motor component

Remove any residue, debris or hair on the end cap and the motor component. Use a damp cloth to wipe clean if needed.

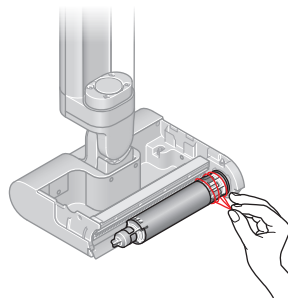

The motor component can be found where the roller connects to the cleaner head.

Clean the squeegee

Check behind the motor component to see if there is any residue left on the squeegee. Use a damp cloth to wipe clean if needed.

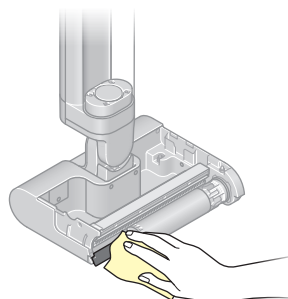

Reattach the roller

Reattach the roller to the end cap. Slide the roller onto the motor component and lock it from the side.

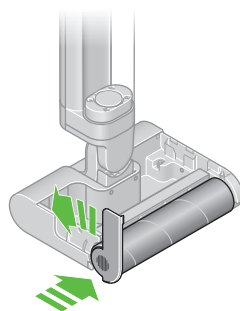

Lock the roller in place by moving the lever on the side of the cleaner head to the horizontal position.

Cleaning the dock

Remove the machine from the dock. Make sure the charger is disconnected from the mains before cleaning. Wipe the dock with warm water, detergent and a cloth. Allow to dry before reconnecting to the mains.

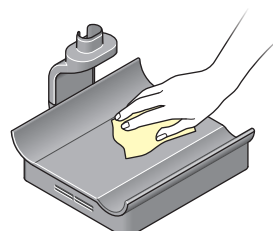

Deep-clean maintenance

Recommended every 6 months

Deep cleaning the debris tray

Remove the waste system

Gently lift the waste system from the cleaner head. Once removed, hold the system upright with the debris tray facing upwards, and dirty water tank below.

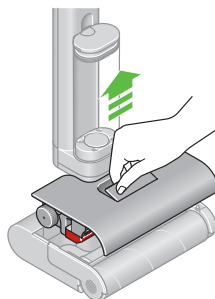

Lift using the red release handle on the top of the waste system.

Dispose dry debris

Pull the debris tray from the side of the system, tap any debris into the bin.

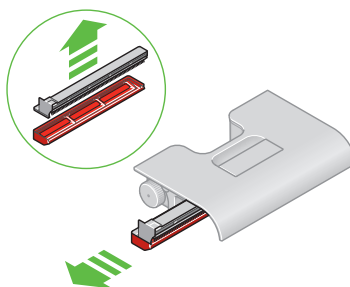

Soak the debris tray

Soak in citric acid/vinegar for one hour to remove limescale.

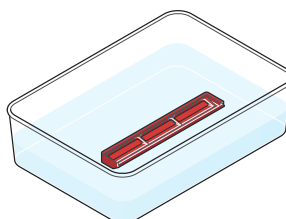

Re-assemble the waste system

Place the debris tray back into the waste system, ensuring it is fitted all the way in.

Replace the waste system

Slot the whole waste system back into the cleaner head. Ensure that it is fully locked into place by pressing firmly on the central red lever until you hear a loud click. Place the machine on the dock.

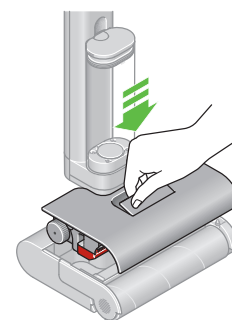
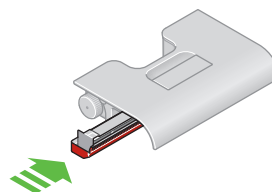

Deep-clean maintenance

Recommended every 6 months

Deep-cleaning the waste tank

Remove the waste system

Gently lift the waste system from the cleaner head. Once removed, hold the system upright with the debris tray facing upwards, and dirty water tank below.

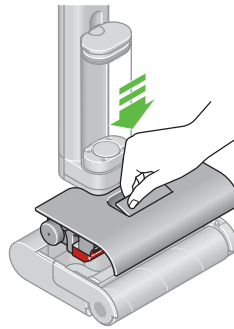

Lift using the red release handle on the top of the waste system.

Remove the debris tray

Pull the debris tray from the side of the system.

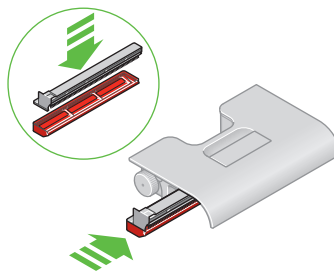

Clean the dirty water tank

Rinse the dirty water tank with warm water and detergent. The whole waste tank can be fully submerged in water and formulation for a deeper clean if necessary.

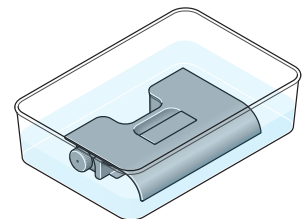
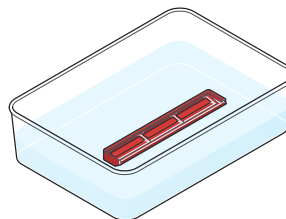

Clean the rubber dirty water tank cap

Rotate and remove the rubber cap from the bottom of the dirty water tank.

Wash in a sink using warm water, gentle detergent and a cloth. Run clean water through the gap on the dirty water tank to remove any remaining dirt.

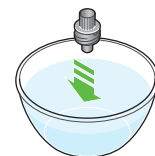
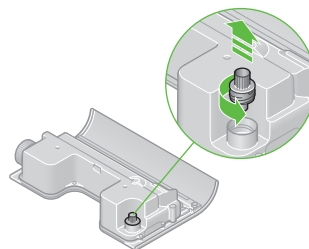

The rubber cap is located on the opposite side to the screw cap on the dirty water tank.

Re-assemble the waste system

Place the debris tray back into the waste system, ensuring it is fitted all the way in.

Replace the waste system

Slot the whole waste system back into the cleaner head. Ensure that it is fully locked into place by pressing firmly on the central red lever until you hear a loud click. Place the machine on the dock.

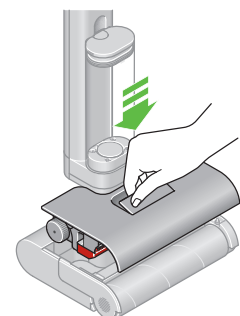
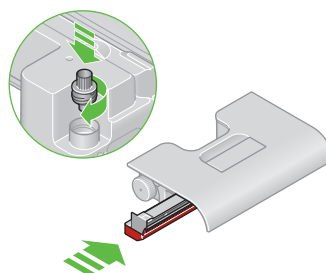

Deep-clean maintenance

Recommended every 6 months

Replace the roller

Your Dyson Clean+Wash Hygiene microfiber roller has a lifespan of 43 hours. We recommend you replace it every 6 months, or when prompted to do so on the LCD screen. A QR code will be displayed for ordering replacements from Dyson.



Caution sign with text reading: Replace roller.

Battery and performance tips

Keep your Clean+Wash Hygiene on the dock and store it in a cool environment (<95° F) to best maintain battery health.

Avoid storing the cleaner with a dirty tank, dirty debris tray or dirty roller – always empty and set to self-clean after use.

Use MAX mode for stubborn stains.

Replace parts promptly when alerted.

Disassemble your machine

Should you need to store or repackage your machine, detach the wand from the main body.

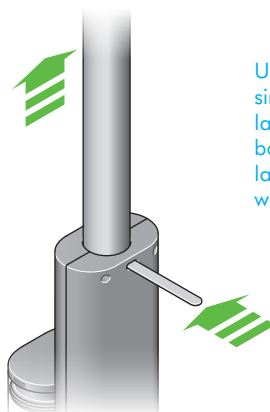

Use a flat head screwdriver or similar tool to depress the release latch and release the wand from the body. The hole to access the release latch is located just below where the wand connects to the body.

Troubleshooting

Excessive water leaking during usage or self-cleaning

Ensure that the debris tray has been assembled correctly, and that the waste system is firmly clicked into the cleaner head.

No water output

Check that the clean water tank is full and seated correctly.

Poor pickup

Clean the roller, debris tray, sprung mangle and squeegee. Replace the roller every 6 months (or sooner, if worn). Your machine will alert you when they need to be changed.

Short run time

Fully charge the battery before use, avoid excessive use of MAX mode.

Dirty Water Tank (DWT) alert

Empty the DWT and place it back properly, ensuring that it's fully clipped in.

Error alert

Refer to MyDyson™ app for guidance.

Support and service

- Visit [Dyson.com](https://www.dyson.com) for videos, tips, and spare parts ordering.
- Contact Dyson Customer Care for assistance.