

FISHER & PAYKEL

VACUUM SEAL DRAWER

MINIMAL VB24SDEB1 & VB30SDEB1

CONTEMPORARY VB24SDEX1 & VB30SDEX1

PROFESSIONAL VB30SPEX1

USER GUIDE

US CA

CONTENTS

Safety and warnings	4
Before you begin	8
Using your vacuum seal drawer	11
Functions	13
Selecting vacuuming levels	17
Food care	18
Care and Cleaning	19
Troubleshooting	22
Service and warranty	24

Registration

To register your product visit our website: fisherpaykel.com/register

⚠ WARNING!



Electric Shock Hazard

Failure to follow this advice may result in electric shock or death.

- If the product is damaged, switch the appliance off and disconnect it from the power supply to avoid possible electric shock.

⚠ WARNING!



Cut Hazard

Failure to use caution could result in injury.

- Take care: some edges may be sharp.
- Do not put fingers in the drawer when closing.

⚠ WARNING!



Hot Surface Hazard

Failure to follow this advice could result in burns and scalds.

- To avoid burns and scalds, keep children away from this appliance.
- Surfaces of the appliance may become hot enough to cause burns.
- Do not touch the sealing bar of the appliance.
- Use protective gloves when handling hot surfaces.
- During and after use, do not touch or let clothing or other flammable materials contact sealing bar of the appliance until it has cooled.

⚠ WARNING!



Fire Hazard

Failure to follow this advice may result in overheating, burning, and injury.

- Flammable materials should not be stored in the appliance or near its surface.

⚠ WARNING!



Tipping Hazard

This product may tip. Keep children away and take care. Failure to follow this advice may result in injury.

- The drawer must be secured in place by supplied screws.
- Ensure there is a fixed shelf directly above the drawer if it is not installed under another product.

READ AND SAVE THIS GUIDE

WARNING!

To reduce the risk of fire, electrical shock, injury to persons or damage when using the appliance, follow the important safety instructions listed below. Read all the instructions before using the appliance. Use the appliance only for its intended purpose as described in these instructions.

General Use

- This appliance is designed for use in a normal domestic (residential) environment.
- Do not use the appliance outdoors.
- Children should be supervised to ensure that they do not play with the appliance.
- This appliance can be used by children aged from 8 years and above and persons with reduced physical, sensory or mental capabilities or lack of experience and knowledge if they have been given supervision or instruction concerning use of the appliance in a safe way and understand the hazards involved.
- To avoid hazard due to instability of the appliance, it must be fixed in accordance with installation instructions.
- Keep the operating panel clean and dry. Wash and dry your hands before operating the drawer to ensure the buttons will respond properly.
- If vacuum-sealing food in bags several times in succession, the heat-sealing bar becomes increasingly hotter. This may impair the quality of the heat-sealing seam. After several vacuum-sealing processes, you must select a lower heat-sealing time or allow the appliance to cool for approximately two minutes between the processes.

Installation

- Ensure your appliance is properly installed and earthed by a qualified technician.
- Ensure this appliance is connected to a circuit which incorporates an isolating switch providing full disconnection from the power supply.
- Do not install or operate the appliance if it is damaged or not working properly. If you receive a damaged product, contact your local dealer or installer immediately.
- Do not install the appliance near a hot gas or electric burner or in a heated oven.

Servicing

- Check the appliance for any damage inside or outside surface of the appliance. Do not use damaged cord or plug. If there is any damage, do not operate the appliance. Contact a Fisher & Paykel trained and supported service technician.
- Do not repair or replace any part of the appliance unless specifically recommended in this user guide. All other servicing must be done by a qualified person or Fisher and Paykel trained and supported service technician.

Cleaning and maintenance

- Ensure the appliance is turned off before cleaning.
- Cleaning and user maintenance shall not be undertaken by children without supervision.
- Use a moderately damp cloth for cleaning. Do not spray water outside or inside the appliance. Water can cause damage inside the appliance.
- Unplug from the power outlet and allow the appliance to cool down after use before cleaning the drawer.

SAFETY AND WARNINGS

- Do not use aggressive or abrasive detergent or sharp metal scrapers for cleaning the glass lid of the appliance. This can scratch the surface which can cause the glass lid to shatter.
- Clean the accessories with soapy water. Do not use a cleaning agent.
- Ensure no liquids or solids get into the suction inlet of the vacuum pump. This would cause irreparable damage to the pump.

Safety

- Do not touch hot surfaces. Use handles or knobs.
- Accessible parts, such as sealing bar, gets hot during use. Use protective gloves or oven cloths.
- Do not sit or lean on the glass lid of the appliance or use it as a storage surface. Damage to the surface of the glass may cause it to shatter.
- Do not operate the appliance if the lid is cracked or broken.
- Do not store hazardous objects that can explode, like containers with gas or air chambers such as spray cans.
- Do not immerse cord, plug or other parts in water or other liquid to protect against electrical shock. Do not let the cord hang over the edge of table or counter, or in a heated oven.
- Do not use accessory attachments that are not recommended.

Packaging disposal

- Remove packaging and recycle materials that can be reused.
- Dispose packaging materials in accordance with local regulations on waste disposal.

WARNING!

This product contains a chemical known to the State of California to cause cancer, birth defects or other reproductive harm.

For more information on these regulations and a list of chemicals, visit:<https://oehha.ca.gov/proposition-65/general-info/proposition-65-plain-language>.

BEFORE YOU BEGIN

- Ensure the installer has completed the final checklist in the installation instructions.
- Read this guide, taking special note of the Safety and warnings section.

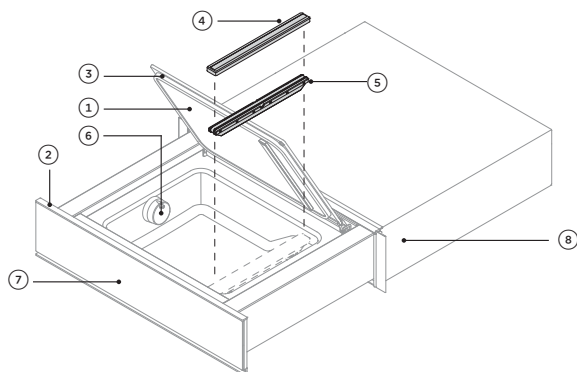

Drawer features

- ① Glass lid
- ② Control panel
- ③ Lid gasket
- ④ Sealing bar
- ⑤ Sealing bar cover
- ⑥ Suction inlet adapter
- ⑦ Push-to-open door*
- ⑧ Serial plate**
- ⑨ Bag clip (not shown)
- ⑩ Handle*** (not shown)

* Available in VB24SD & VB30SD models

** Located inside the chassis of the drawer

*** Available in VB30SP models

BEFORE YOU BEGIN

Control panel

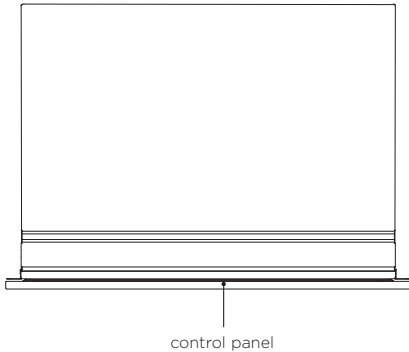
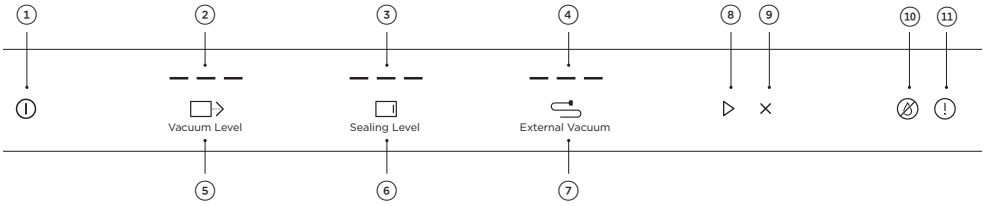

Control panel features

- ① Power On/Off
- ② Vacuum level indicator
- ③ Sealing Level indicator
- ④ External vacuum indicator
- ⑤ Vacuum level control
- ⑥ Sealing level control
- ⑦ Suction inlet adapter
- ⑧ Start
- ⑨ Cancel
- ⑩ Moisture indicator
- ⑪ Maintenance indicator

Using the touch controls

Your Vacuum Seal Drawer is operated using a touch control panel. To operate the control panel, use the ball of your finger, not its tip. The controls respond to touch, so pressure is not needed.

Keep the operating panel clean and dry. Wash and dry your hands before operating the drawer to ensure the buttons will respond properly.

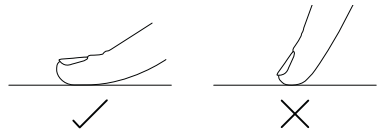

BEFORE YOU BEGIN

Selecting a vacuum bag

- Your Vacuum Seal Drawer is supplied with two different sized vacuum bags. Each bag can be used within temperatures of -40 °F (-40°C) to 239 °F (+115°C).
- DO NOT use polycarbonate plastic bags. These can become soft and can damage the sealing bar.
- Other bags, such as resealable freezer bags, should only be used for vacuum sealing and the sealing time must be adjusted to suit the material of the bag. Refer to 'Selecting vacuuming levels' for more information.

Preparing the food

- Never vacuum seal warm or hot food.
- A bag containing food that has been sealed under vacuum must be pierced or opened before microwaving. Build up of pressure can cause the vacuum bag to burst.

Filling the vacuum bag

- When filling the bag, ensure the sealing portion of the bag remains clean in order to seal properly.
- Fold the top of the bag down (inside facing out) before filling.
- The bag should only be filled to two-thirds of its capacity.

If vacuum-sealing food in bags several times in succession, the heat-sealing bar becomes increasingly hotter. This may impair the quality of the heat-sealing seam. After several vacuum-sealing processes, you must select a lower heat-sealing time or allow the appliance to cool for approximately two minutes between the processes.

USING YOUR VACUUM SEAL DRAWER

First time use

If using the vacuum seal drawer for the first time, two LEDs in vacuum level indicators and two LEDs in sealing level indicators are illuminated at start up.

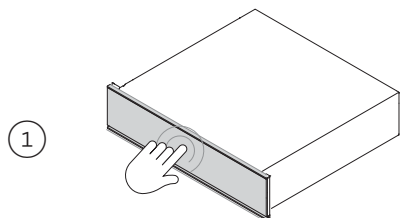

For push-to-open models, press the center-front of the drawer to open. Do not force the drawer open.

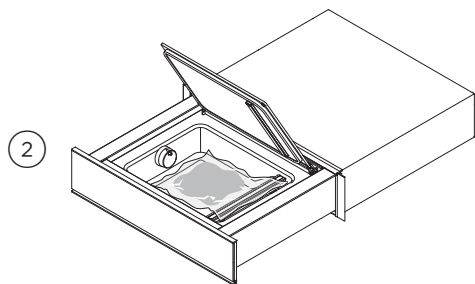

Place the food inside the vacuum bag. Open the glass lid and place the bag inside the drawer. Secure the opening of the bag under the bag clip and position across the sealing bar.

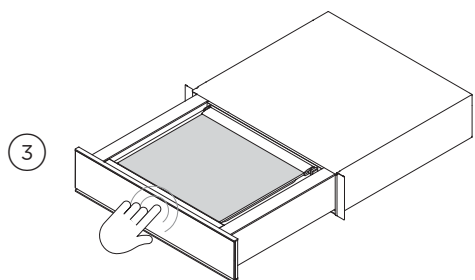

Close the lid and select the function you want to use. Press the center of the door to close the drawer.

USING YOUR VACUUM SEAL DRAWER

Switching ON the Vacuum Seal Drawer



Touch the **I** button on the control panel to switch on the Vacuum Seal Drawer.

A tone will sound indicating the drawer is now ready to use.

Switching OFF the Vacuum Seal Drawer



Touch the **I** button on the control panel to switch off the Vacuum Seal Drawer.

A tone will sound when the process is complete.

Cancelling the operation



Touch **X** to cancel if you wish to stop the operation at any point during the vacuuming process.

If the bag is not sealed, the vacuuming process (ventilation running) cannot be interrupted.

Vacuuming and sealing function

This is the standard function of the Vacuum Seal Drawer. Underpressure is generated inside the vacuum tank which seals the opening of the bag inside the drawer.

If you vacuum-seal food in bags several times in succession, the heat-sealing bar becomes increasingly hotter. After several vacuum-sealing processes, you should select a lower heat-sealing time or allow the appliance to cool for approximately two minutes between the processes.

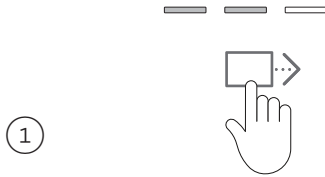

Touch the vacuum level button once or more to select a suitable vacuuming level. Refer to 'Selecting Vacuum Levels'.

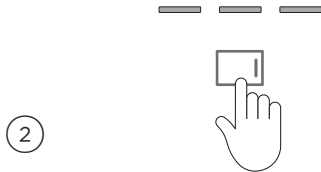

Touch the sealing level button to select a suitable level for sealing time. Refer to 'Selecting Seal Levels'.



Close the glass lid and touch the start button.

Once the pressure is equalized, the process is complete and a tone will sound.

FUNCTIONS

Vacuuming function

Suitable for vacuuming and airtight-sealing jars with screw-top lids. Jars must not be more than 3 3/8" (85mm) in height to avoid damaging the glass lid when closing the drawer.

①

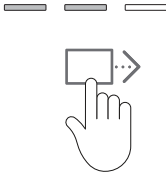

Loosely close the screw-top lid of the jar before placing inside the Vacuum Seal Drawer.

Touch the vacuum level button to select a suitable vacuuming level.

Refer to 'Selecting Vacuuming Levels' for more information.

②



Touch the sealing level button repeatedly until all sealing level indicators dim.

③



Close the glass lid and touch the start button.

FUNCTIONS

Sealing function

Suitable for closing a bag airtight without creating a vacuum.

If you seal food in bags several times in succession, the heat-sealing bar becomes increasingly hotter. After several sealing processes, you should select a lower heat-sealing time or allow the appliance to cool for approximately two minutes between the processes.

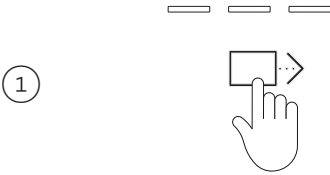

Touch the vacuum level button repeatedly until all vacuum level indicators dim.

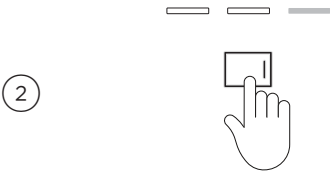

Touch the sealing level button to select a suitable level for sealing time.



Close the glass lid and touch the start button.

FUNCTIONS

External vacuuming

Select this function to release air out of glass bottles containing, eg oil or wine to prevent reaction with oxygen.

Ensure that the vacuum container is safe for use with food or use a commercially available vacuum container.

For external vacuuming of glass bottles, only use bottles that are suitable for vacuuming. Unsuitable or damaged bottles could implode during external vacuuming and cause injury.

When evacuating air from wine bottles, set external vacuuming to level 1 to avoid gas in the wine from being affected.

An external vacuuming accessories kit is supplied for this function. The kit includes a suction inlet adapter, a tube, a vacuum stopper and a stopper adapter.

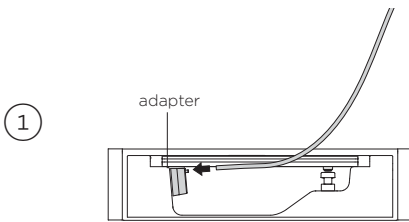

Connect one end of the suction tube to the large adapter attached to the suction inlet in the vacuum tank.

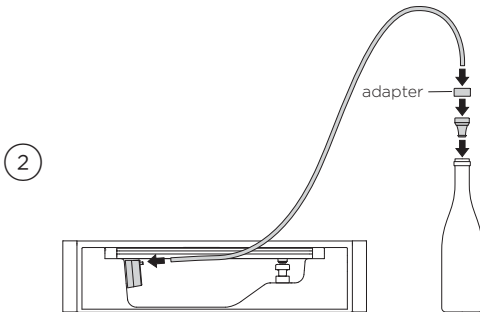

To release air from the bottle:

Place the bottle on a flat and stable surface near the drawer.

Connect the stopper adapter to the other end of the tube, and connect the adapter to the vacuum stopper of the bottle.

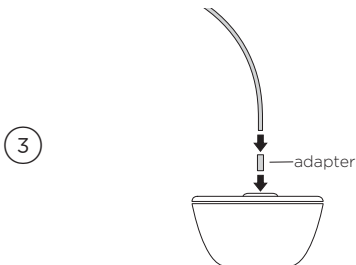

To release air from the vacuum container:

Connect the other end of the tube to the vacuum container. Use an adapter if necessary.

SELECTING VACUUMING LEVELS

Refer to the table below for available vacuuming levels (after portioning) for packaging, marinating, sous vide cooking, freezing or storing:

LEVEL INDICATOR	FOOD CATEGORY	DESCRIPTION
<p>0 (sealing only)</p> 	<ul style="list-style-type: none"> Fragile and delicate food, such as crisps and salad. 	<ul style="list-style-type: none"> Seals fragile and delicate food to keep shape and consistency. Vacuuming is not necessary.
<p>1</p> 	<ul style="list-style-type: none"> Soft fruit, e.g. berries, plums, apricots, bananas. Liquids such as soups, sauces Foods with liquid such as meat with a lot of marinade. Jars and bottles, e.g. jars of nuts, seeds and opened jars of sauces. 	<ul style="list-style-type: none"> Retains the shape and consistency of fragile and delicate fruits. Vacuum food e.g. meat marinated with vinegar or wine. Reduces oxidation of wine and vinegar. Opened jars can be sealed airtight again Vacuum seals nuts or seeds, etc. to protect against infestation or oxidation. Evacuates air from bottles of oil and wine.
<p>2</p> 	<ul style="list-style-type: none"> Firmer fruits such as apples and pears. Softer vegetables such as bell peppers, tomatoes and zucchini. Fish, whole unskinned or filleted. Foods with some liquid, e.g. meat with a little marinade. 	<ul style="list-style-type: none"> Vacuum seals firmer fruit. Ideal for vegetables. Suitable for meat in a sauce or with a little marinade.
<p>3</p> 	<ul style="list-style-type: none"> Meat, e.g. medallions, steak. Firm or root vegetables, e.g. carrots, beetroot, sweet potato. Food for freezing Hard cheese for storing. 	<ul style="list-style-type: none"> Seasoned meat without added liquid. Firmer vegetables for sous vide cooking. Food to be frozen. Extracting the air helps prevent freezer burn.

Quality and hygiene

The initial bacterial content of food determines how long a product can be preserved. The higher the bacterial content, the shorter the maximum storage time. In order to preserve food for as long as possible, only vacuum seal food that is in perfect condition. Products that have been kept for some time before vacuum sealing have a higher bacterial content and are therefore not suitable for long-term storage.

To prevent fresh food from being contaminated with bacteria, the following points should be observed:

- Wash hands well before handling food.
- Ensure food preparation surfaces are smooth and hygienically clean.
- Clean all utensils (knives, forks, spoons, etc.) before use.

Preparing special types of food

Some types of food may require special preparation before they can be stored.

Blanching

Brassica vegetables (such as cauliflower, broccoli, white cabbage, red cabbage), pulses (fresh beans, peas), and stalks and shoots (asparagus), should be blanched before vacuum sealing to release gas. Blanch in a steam cooker or in boiling water before running the vegetables under cold water or place in an ice bath to chill quickly. Vacuum sealing your food can reduce storage space in your freezer.

Storage

To store food safely, the following points must be observed:

- Food that is to be stored must be fresh and in perfect condition.
- Food must be at storage temperature before vacuum sealing.
- Where possible, dry the food before vacuum sealing.
- Avoid mixing raw and cooked foods.
- Select the highest level of vacuuming possible. Refer to 'Selecting Vacuuming Levels' for recommended levels.
- Large pieces of food can be preserved for longer than smaller pieces.
- Store food at the lowest temperature as much as possible.

Vacuum sealed food can be steamed at a low temperature in a steam cooker or in our Fisher & Paykel Combi-Steam ovens using Sous Vide function. Use only the vacuum bags supplied by Fisher & Paykel for this method.

CARE AND CLEANING

Ensure that the appliance is turned off or set in **STANDBY** mode before cleaning.

External cleaning

- Remove any soiling or excess cleaning agent immediately.
- Clean the surfaces with a soft cloth dampened with water and a little washing-up liquid for metallic surfaces. Rub in the direction of the original polish lines.
- Dry with a soft cloth.

Internal cleaning

- Remove the sealing bar and sealing bar cover from the appliance.
- Remove any soiling or excess cleaning agent immediately.
- Clean the surfaces with a soft cloth dampened with water and a little washing-up liquid for metallic surfaces. Rub in the direction of the original polish lines.
- Dry with a soft cloth.
- Clean the sealing bar with a soft cloth dampened with water and a little washing-up liquid and dry with a soft cloth. The sealing bar cover can be cleaned in the dishwasher.
- Put the sealing bar cover back in place in the appliance.
- Position the sealing bar on the two locating pins in the appliance.

Drawer lid gasket

- Clean the appliance lid gasket with a soft cloth dampened with water. Do not use detergent and dry with a soft cloth.

Parts used in external vacuuming

Clean the external vacuuming parts (adapters, tube, and vacuum stopper) with hot water and small amount of washing-up liquid. Wipe dry with a soft cloth or sponge.

Replacing the sealing bar

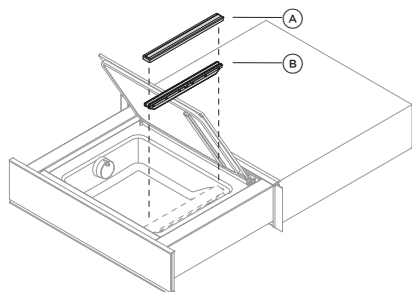

- ① Remove the sealing bar (A) together with the sealing bar cover (B) from the appliance.
- ② Mount the sealing bar cover in place to the appliance.
- ③ Position the new sealing bar on two locating pins in the appliance.

Replacing the drawer lid gasket

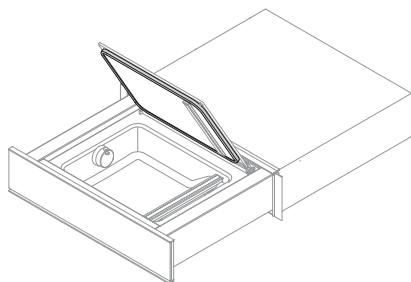

- ① Remove the damaged lid gasket
- ② Fit the new appliance lid gasket.

Replacing the seal pad

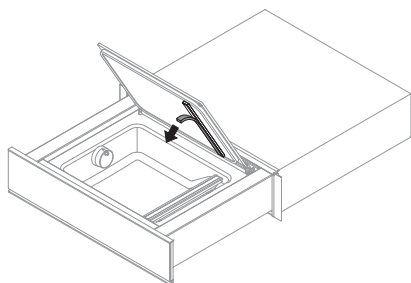

The seal pad is located on the underside of the drawer lid.

- ① Remove the damaged seal pad from the holder.
- ② Insert the new seal pad in the holder.

CARE AND CLEANING



System check

If the maintenance button illuminates, the vacuum pump cannot achieve the required underpressure in the allotted time. The drawer lid may not be closed properly or the lid gasket may be dirty or damaged.



- ① Clean the lid gasket. Do not use any cleaning agents.
- ② Close the drawer lid and press down.
- ③ If after the next vacuuming process the button remains illuminated, a lower vacuuming level must be selected.
- ④ If the button lights up repeatedly, wait until  illuminates and dehumidify the vacuum pump.

Dehumidifying



Dehumidification is necessary when the oil in the vacuum pump contains too much water from frequently vacuuming moist foodstuffs.

If  and  buttons illuminate, the oil in the vacuum pump can be dehumidified.

Close the drawer lid and touch the  button to start dehumidification.

If  and  buttons illuminate, the oil in the vacuum pump must be dehumidified.

Close the drawer lid and touch the  button to start dehumidification.

The dehumidifying process takes a maximum of 20 minutes. If the button remains illuminated, the process must be repeated. It is necessary to wait for one hour between dehumidifying processes as the oil in the vacuum pump gets hot. During this time,  and  are illuminated, but they cannot be operated.

TROUBLESHOOTING

If there is a problem with your oven, please check the following points before contacting your local Fisher & Paykel trained and supported service technician or the Customer Care Center.

PROBLEM	POSSIBLE CAUSES	SOLUTION
The appliance is not working	A household fuse or circuit breaker has tripped due to an overload.	Replace the fuse or switch the circuit breaker back on again.
	The fuse or circuit breaker keeps blowing.	Contact customer support
	An interruption in the power supply.	Check the power supply.
	The appliance is faulty.	Contact customer support
	Repeated vacuuming has caused the appliance to overheat.	Allow the appliance to cool down before using again. Wait for two minutes after each vacuuming.
	The appliance is in a cooling phase between two dehumidifying processes. During this time, Ⓜ and Ⓛ buttons are illuminated, but they cannot be operated.	Wait one hour before repeating the dehumidifying process.
Insufficient vacuum in the bag	The vacuuming level selected was too low for the particular foodstuff used.	Select the next highest level.
	The suction inlet of the vacuum pump is obstructed.	Ensure the bag is not obstructing the suction inlet of the vacuum pump.
	The bag is not airtight.	Vacuum seal the food in a new bag, selecting a higher level for the sealing time if necessary.
The liquid in the vacuum bag is boiling vigorously while being vacuumed	Liquids start to boil at low temperatures when under high vacuum.	Select vacuuming level 1 for vacuuming liquid foodstuffs.
		Sealing sooner
No vacuum is being created in the bottle during external vacuuming	The tube and vacuum stopper are showing signs of wear and tear.	Replace the tube and vacuum stopper with new ones.

TROUBLESHOOTING

PROBLEM	POSSIBLE CAUSES	SOLUTION
The vacuum bag is incorrectly sealed	The sealing time set was insufficient for the selected vacuuming level.	Select the next highest sealing time level.
	The vacuum bag is not positioned correctly on the sealing bar.	Adjust the position of the vacuum bag.
	The vacuum bag is contaminated around the sealing seam.	Clean the sealing area before the process.
	The seal pad, located on the appliance lid, is very worn.	Replace the seal pad.
	Repeated vacuuming has caused the appliance to overheat.	Allow the appliance to cool down before using again.
	The seal pad, located on the appliance lid, is very worn.	Replace the insulation for the sealing bar.
The appliance lid could not be open	The appliance is in operation.	Wait until the appliance is ventilated at the end of the process and an acoustic signal is emitted.
	There was an interruption in the power supply.	Reconnect the power supply. The appliance is being ventilated.
Noises can be heard during operation	Appliance can make noises during operation (e.g. switching and pumping noises).	This is normal.
The maintenance button illuminates	The pump output is reduced.	Dehumidify the oil in the vacuum pump when the button illuminates.
	The appliance cannot reach the desired under-pressure.	Hold the appliance lid down when starting the vacuuming process.
		Check the appliance lid gasket and the contact surface of the gasket and clean if necessary. If the gasket is not lying flat, smooth it out with a finger.
		Select a lower vacuuming level, e.g. for food with liquid.
		If the vacuum bag is protruding from under the appliance lid gasket, position the bag correctly.

SERVICE AND WARRANTY

Before you call for service or assistance

Refer to the installation instructions and your user guide and check that:

- Your product is correctly installed.
- You are familiar with its normal operation.
- Model number.
- Serial number (can be found on the inside, right side panel behind the drip pan handle.
- Code (can be found on the inside, right side panel behind the drip pan handle.
- Date of installation

If after checking these points you still need assistance or parts, please refer to the Service & Warranty book for warranty details and your nearest Service Center, Customer Care, or contact us through our website www.fisherpaykel.com or email: customer.care@fisherpaykel.com

Complete and keep for safe reference:

Mode _____

Serial No. _____

Purchase Date _____

Purchaser _____

Dealer _____

Suburb _____

Town _____

Country _____

FISHERPAYKEL.COM

© Fisher & Paykel Appliances 2020. All rights reserved.

The models shown in this guide may not be available in all markets and are subject to change at any time.

The product specifications in this guide apply to the specific products and models described at the date of issue. Under our policy of continuous product improvement, these specifications may change at any time.

For current details about model and specification availability in your country, please go to our website or contact your local Fisher & Paykel dealer.

591995A 07.20