

# Renogy

## Pure Sine Wave Inverter

24V | 2000W

RIV2420P2-12S

VERSION A0

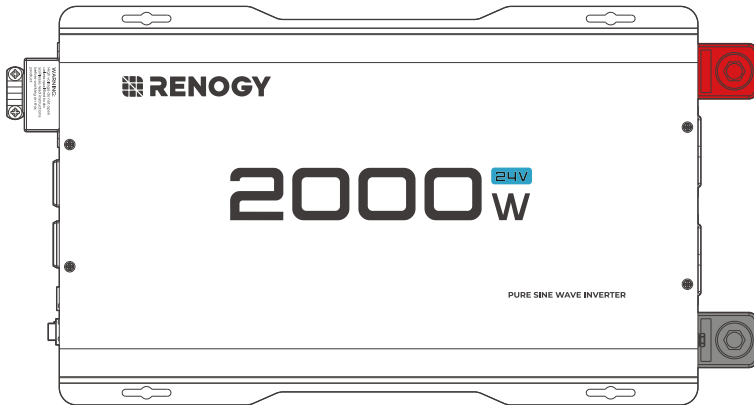

# USER MANUAL

# Table of Contents

Before Starting.....	01
Disclaimer .....	01
Symbols Used.....	02
Introduction .....	02
Key Features .....	02
SKU.....	02
What's In the Box? .....	03
Required Tools & Accessories.....	03
Get to Know the Pure Sine Wave Inverter .....	04
Dimensions.....	05
System Setup .....	06
Size a Battery Bank .....	07
Step 1. Wear Insulating Gloves .....	07
Step 2. Plan a Mounting Site.....	08
Step 3. Ground .....	09
Step 4. DC Wiring .....	09
Step 5. AC Wiring.....	11
Power On/O! .....	11
LED Overview & Troubleshooting.....	13
Pure Sine Wave.....	14
General Safety Information .....	14
Specifications .....	15
Renogy Support .....	16

## Before Starting

The user manual contains important operating and maintenance instructions for the Renogy 24V 2000W Pure Sine Wave Inverter (hereinafter referred to as the inverter).

Read the user manual carefully before commissioning and keep it for future reference. Failure to follow the instructions or precautions in the user manual may result in electric shock, serious injury or death or damage the inverter, possibly rendering it inoperable.

- Renogy guarantees the accuracy, completeness and applicability of the information in the enclosed operating instructions at the time of printing. However, due to possible continuous product improvements, Renogy assumes no liability or responsibility for any errors or omissions in the manual.
- Renogy accepts no responsibility or liability for personal injury or damage to property, whether direct or indirect, caused by the user not installing and using the product in accordance with the operating instructions.
- Renogy accepts no responsibility or liability for failure, damage or injury caused by attempted repair by unqualified personnel, improper installation or improper operation.
- The illustrations in the user manual are for demonstration purposes only. Details may vary slightly depending on the product version and market region.
- Renogy reserves the right to change the information in the user manual without prior notice. For the latest user manual, visit [renogy.com](https://www.renogy.com).

## Disclaimer



Renogy 24V 2000W Pure Sine Wave Inverter User Manual © 2024 Renogy. All rights reserved.

RENOGY and **RENOGY** are registered trademarks of Renogy.

- All information in this user manual is subject to copyright and other intellectual property rights of Renogy and its licensors. The User Manual may not be modified, reproduced or copied in whole or in part without the prior written permission of Renogy and its licensors.
- The registered trademarks in the user manual are the property of Renogy. Unauthorized use of the trademarks is strictly prohibited.

## Symbols Used

The following symbols are used throughout the user manual to highlight important information.

-  **WARNING:** Indicates a potentially **hazardous** condition that could result in injury **or death**.
-  **CAUTION:** Indicates an important procedure for **safe** and proper **installation** and operation.
-  **NOTE:** Indicates an important step or tip for **optimum performance**.

## Introduction

The Renogy 24V 2000W Pure Sine Wave Inverter (hereafter referred to as the inverter) is perfect for most off-grid systems, whether it's for a van, a semi-truck, an RV, a cabin, or any other remote location that requires power. The inverter converts the direct current stored in the batteries into usable alternating current for appliances. Thanks to Renogy's advanced pure sine wave technology, you can power almost any AC appliance without damaging even your most sensitive devices.

## Key Features

- **Powerful DC-AC conversion**  
Continuous rated output power with a maximum conversion efficiency of 93 % and up to 2-fold overvoltage for starting loads.
- **Guaranteed protection for household appliances**  
Pure sine wave technology is similar or even better than mains power and can extend the life of appliances as it delivers a smooth sine wave that won't damage them. There are no strange humming noises and your appliances can run smoothly.
- **Easy to use**  
Provides an integrated 5V/2.1A USB port, AC power outlet(s), hardwired AC output terminal and wired remote control port.

## SKU

Renogy 24V 2000W Pure Sine Wave Inverter	RIV2420P2-12S
--	---------------

## What's In the Box?

Renogy 24V 2000W  
Pure Sine Wave Inverter × 1

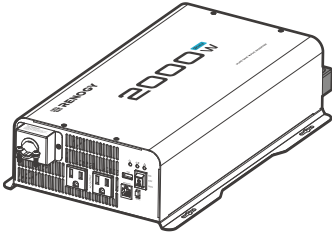

User Manual × 1

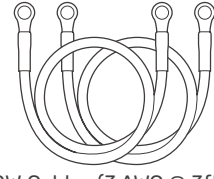

2000W:Cables (3 AWG @ 3ft) × 2



Wired Remote  
Control × 1



RJ12 Ethernet Cable  
(5m) × 1

- i** Make sure that all accessories are complete and free of any signs of damage.
- i** The accessories and product manual listed are crucial for the installation, excluding warranty information and any additional items. Please note that the package contents may vary depending on the specific product model.

## Required Tools & Accessories



Phillips Screwdriver (#1)

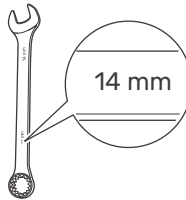

Wrench (9/16 in)

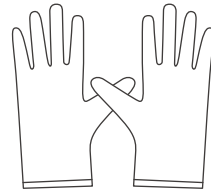

Insulating Gloves



Slotted Screwdriver (1 mm)



Wire stripper

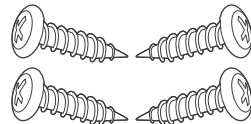

Self-tapping Screws (ST4 or ST6) × 4

- i** Prior to installing and configuring the inverter, prepare the recommended tools, components, and accessories.
- i** Choose proper mounting screws specific to your installation site. This manual takes self-tapping screws for wooden walls as an example.

# Get to Know the Pure Sine Wave Inverter

## AC Side View

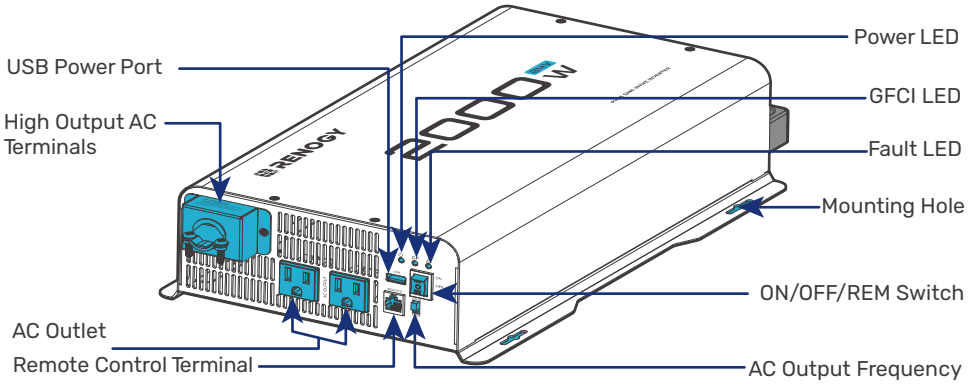

Part	Description
<b>ON/OFF/REM Switch</b>	Turns the inverter ON, OFF, or REMOTE.
<b>Power LED</b>	Indicates the operation status of the inverter.
<b>Fault LED</b>	Indicates that the inverter shuts down due to overheating, overload, undervoltage, or overvoltage. Solution: Immediately turn off all AC appliances. Allow the inverter to cool before continuing. Make sure that the ventilation vents are not blocked. Ensure all cables are of proper sizes and lengths.
<b>GFCI LED</b>	Indicates that the ground fault circuit has been interrupted. In such case, restart the inverter.
<b>High Output AC Terminals</b>	Remove the two screws on the protective cover to access 20A the terminals. Remove the two screws on the protective cover to access the terminals. Terminal layout (facing the front panel) <ul style="list-style-type: none"> <li>● Left: Live (L)</li> <li>● Middle: Neutral (N)</li> <li>● Right: Ground (G)</li> </ul> Note that Neutral and Ground are bonded inside.
<b>AC Outlet</b>	120V AC, 50/60 Hz, Up to 15A.
<b>USB Power Port</b>	Supplies 5V/2.1A for charging tablets, smartphones, and other small appliances.
<b>Remote Control Terminal</b>	Connects to the Wired Remote Control.
<b>AC Output Frequency</b>	Configure the AC output frequency of the inverter in accordance with the frequency of the connected AC loads.

## DC Side View

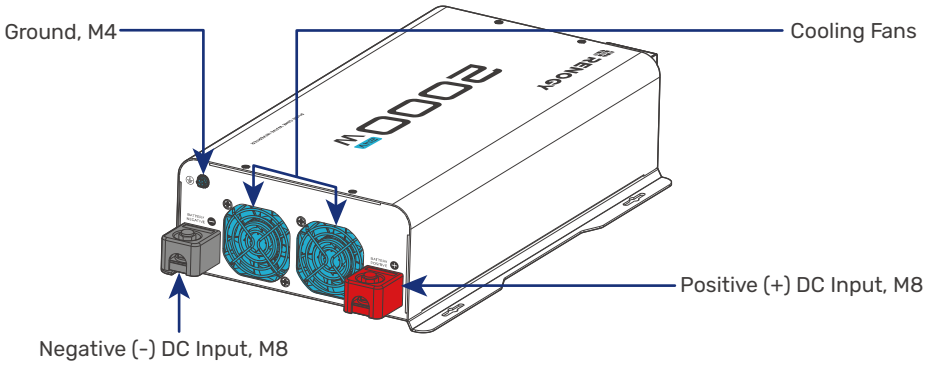

## Dimensions

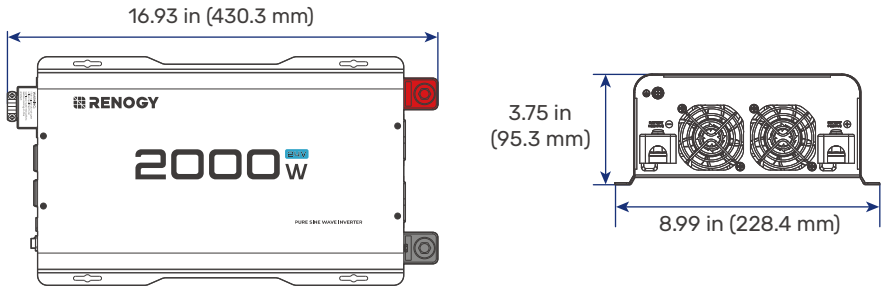

**i** Dimension tolerance:  $\pm 0.2$  in (0.5 mm)

# System Setup

## AC Side View

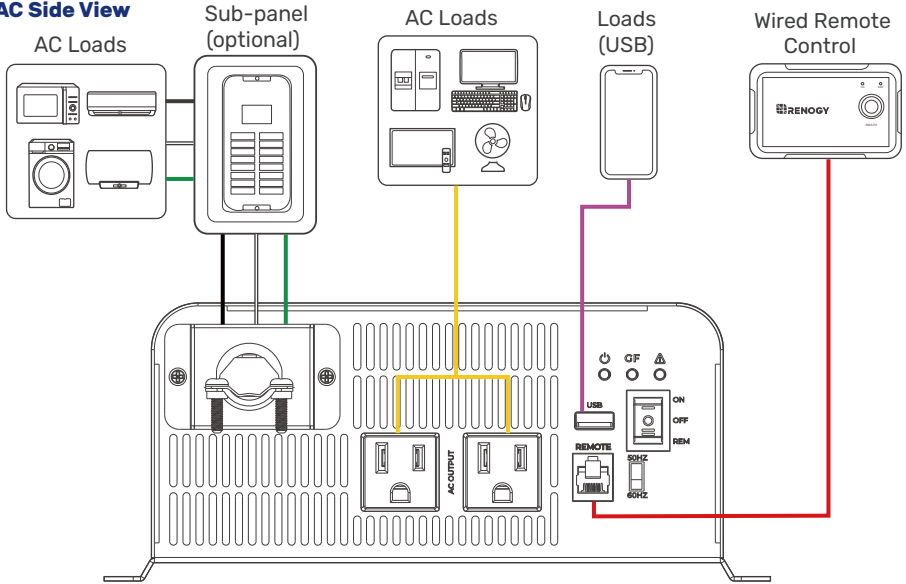

- Live wire (AC)
- Ground
- Remote control
- Neutral wire (AC)
- AC
- USB

## DC Side View

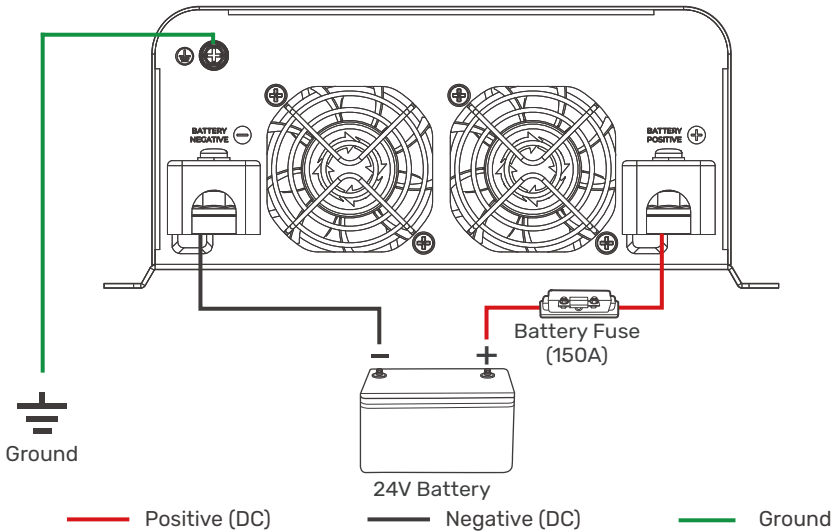

- Positive (DC)
- Negative (DC)
- Ground

**i** The 2000W inverter requires a 150A battery fuse.

## Size a Battery Bank

Battery types and capacity relate to the overall inverter performance. To size a proper battery bank, you need to identify the loads that you will be utilizing, as well as an estimate duration (hours/day) you will be using the load. The inverter is only compatible with 24V battery banks, and oversizing should be considered due to efficiency losses.

### 1. Determine Your Watts (Amps x Volts)

Every electronic will have a sticker or plate identifying the watts directly (W) or will show you the voltage value (V) as well as amperage (A) which need to be multiplied to get Watts. The formula is below:

$$\text{Watts (W)} = \text{Volts (V)} \times \text{Amps (A)}$$

$$\text{Example: Fan Watts} = 120\text{V} \times 0.4\text{A} = 48\text{Watts}$$

### 2. Estimate Load Run-Time in Watt-Hours (Wh)

Estimate how many hours per day you will be using the load and multiply this by your Watts per load.

$$\text{Example: Fan Watts} \times 12 \text{ hours} = \text{Watt-Hour (Wh)}$$

$$48\text{W} \times 12\text{h} = 576\text{Wh}$$

### Determine Battery Capacity in Amp-Hour (Ah)

Divide your Load Run Watt-Hour result by the battery voltage.

$$\text{Load Run-Time (Wh)} / \text{Battery Voltage (V)} = \text{Amp-Hour (Ah)}$$

Use 24V, supported voltage of the inverter as a reference.

$$576\text{Wh} / 24\text{V} = 24 \text{ Ah}$$

### Oversize the Battery

The calculated Amp-Hour value represents the minimum size battery capacity to run your load for your intended time. Note that this assumes 100% use of a battery, which is not recommended. Assuming 50% depth of discharge, you want to multiply this value by 2 and you also want to multiply by 1.25 to account for some efficiency losses.

Formula:

$$24\text{Ah} \times \text{Oversize} \times \text{Efficiency Losses} = \text{Recommended Amp-Hour}$$

$$24\text{Ah} \times 2 \times 1.25 = 60\text{Ah}$$

Therefore, a 60Ah battery bank, or close, will be able to support a 12-hour run time while also prolonging battery life for the best system size possible.

 You will need a battery charging source as this is a non-charging inverter and will only work to deplete the battery.

 Actual battery quantities vary by battery capacity and rates of discharge.

## Step 1. Wear Insulating Gloves

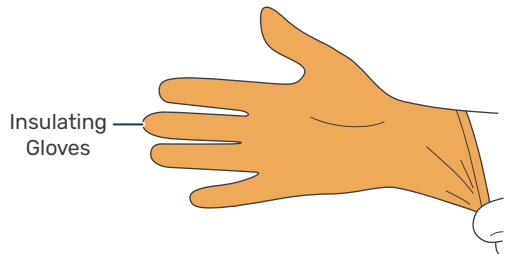
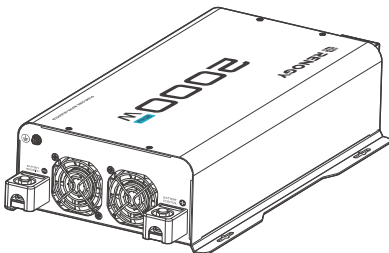

## Step 2. Plan a Mounting Site

Follow the guidelines below:

- **Cool, dry, well-ventilated area**

The inverter must be installed in a site where the fans are not blocked or where they are not hit directly by the sun. The site should be free of any kind of moisture with a clearance of at least 10 inches around the inverter for adequate ventilation.

- **Protection against fire hazard**

The inverter should be away from any flammable material, liquids, or any other combustible material.

- **Close proximity to battery bank**

Put the inverter close to battery banks to prevent excessive voltage drop. Choose a proper sized wire going from the battery bank to the inverter.

- **Limiting electromagnetic interference (EMI)**

Ensure the inverter is firmly grounded to a building or vehicle. Alternatively, it can be earth grounded. Keep the inverter away from EMI receptors such as TVs, radios, and other radio/visual electronics to prevent damage/interference.

- **Secure mounting**

The inverter should stand-alone or mounted by using the outlying terminals with M4 and M6 screws on the inverter.

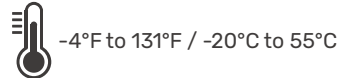
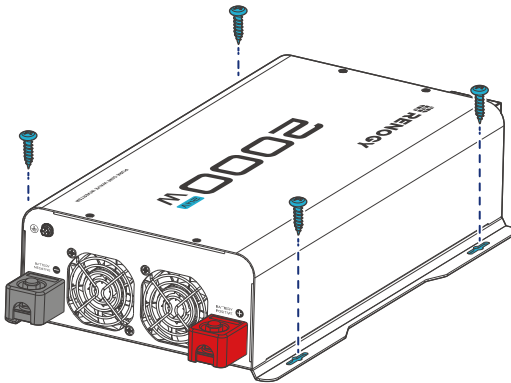

-4°F to 131°F / -20°C to 55°C

- ⚠ Do not over-torque or overtighten the terminals. This could potentially damage the unit.
- ⚠ Refer to the technical specifications for maximum wire sizes on the controller and for the maximum amperage going through wires.
- ⚠ Ensure the inverter is in the OFF position before connecting to anything.
- ⚠ Do not install the inverter in the same compartment as the battery bank because it could serve as a potential fire hazard.
- ⚠ Never mount the inverter vertically on a vertical surface since it would present a hazard for the fan opening, undermining cooling the inverter.

## Step 3. Ground

If available, the chassis ground lug should be connected to a ground point such as a vehicle chassis or boat grounding system. In fixed locations, connect the ground lug to earth ground. The connections to ground must be tight and against bare metal. Grounding is highly recommended for both when using the inverter in a mobile application, such as an RV, or in a building.



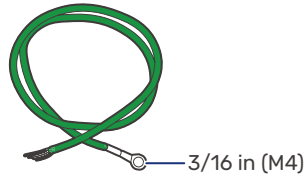

### Empfohlene Komponenten

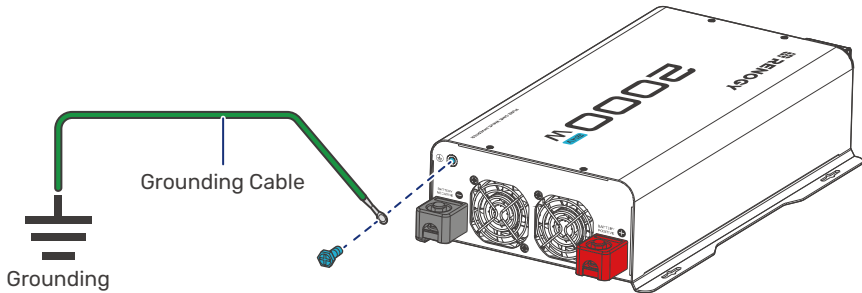

Grounding Cable (12 AWG)



## Step 4. DC Wiring

-  Be careful of the positive and negative poles. Reversing the poles might cause permanent damage to the inverter and will void the warranty.
-  For your safety, it is recommended to use a 150A battery fuse.
-  The inverter is suitable for 24V battery bank systems ONLY. Not following the minimum DC requirement will cause irreversible damage to the device.
-  The input terminals of the inverters are embedded with large capacitors. The input circuit is completed once the terminals are connected to both positive and negative wires. This commences drawing a heavy current momentarily. As a result, there may be a sparking occurring even if the inverter is in the off position. To minimize sparking, it is recommended that you should choose an appropriate sized wire feeding into the inverters and/or install an external fuse leading into the inverter.

**Step 1:** On the AC side, set the ON/OFF Switch to the OFF position.

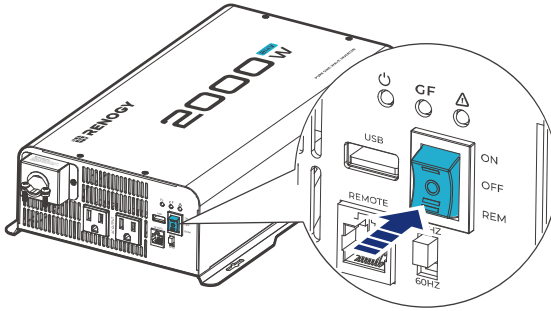

**Step 2:** On the DC side, remove the protection caps.

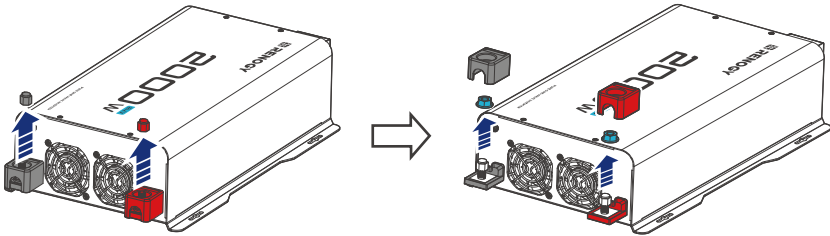

**Step 3:** Unscrew Positive and Negative DC Input Terminals, connect a battery **bank** to the terminals, and tight the terminal screws. Torque: 14(±0.5) N·m

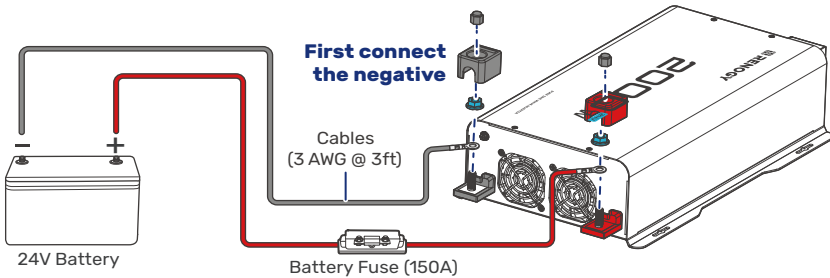

Cables	Battery Fuse
2000W: Cables (3 AWG @ 3ft)	2000W: 150A

## Step 5. AC Wiring

### AC Outlets

You can plug your AC loads directly into the AC Outlets on the inverter's AC side.

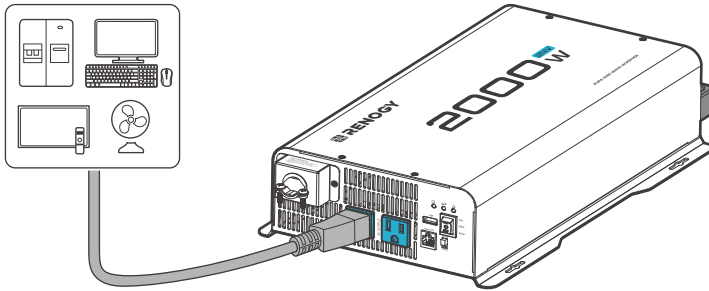

### High Output AC Terminals

You can also permanently connect the AC output from the AC hardwire terminal through the High Output AC Terminals into a load sub-panel or additional AC outlets powered by the 2000W inverter.

From left to right, the terminal block indicates: Live/Hot (L), Neutral (N) and Ground (G).

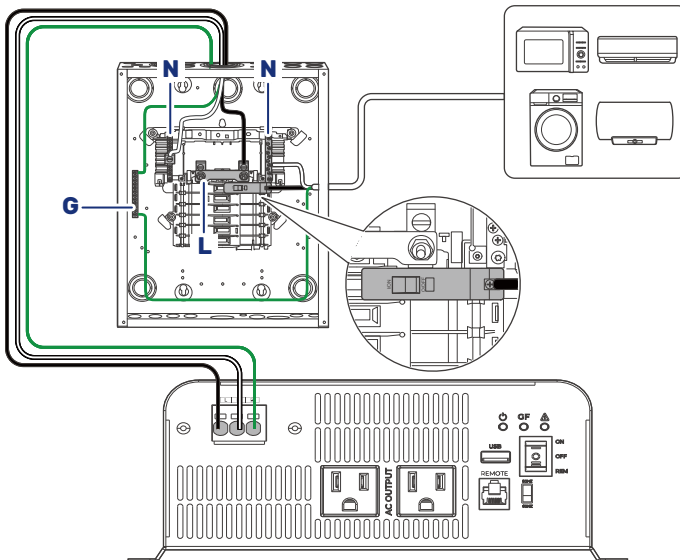

## Power On/Off

### Operations on Inverter

After proper battery and AC load connections, you can operate the inverter.

1. On the AC side, rock the ON/OFF Switch to the ON position.
2. The inverter is operating normally.

When finishing using the inverter, power off the AC loads first, and then rock the ON/OFF Switch to the OFF position.

## ■ How to Properly Install Cable Clamps?

The AC Output Port with cable clamps to ensure that the wiring connections remain secure and do not come loose due to vibrations.



Step 1: Loosen the screws on a cable clamp with a Phillips Screwdriver.

Step 2: Lift the clamp, and run the cables through the clamp.

(You will need 1 x 3 prong (10 AWG recommended Black, White, Green) ac cables not provided with this product. Measure the required length for your particular application for ac output of the inverter. SJT0 and SJT, SJO are recommended wire)

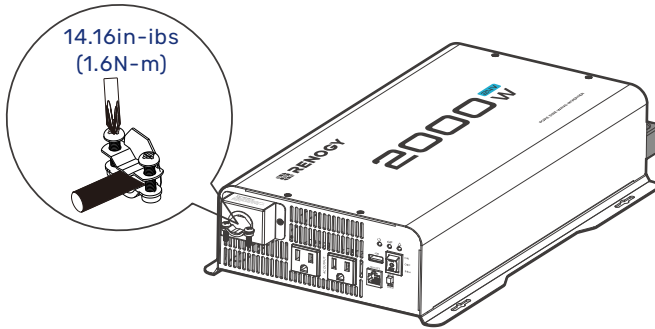
Step 3: Secure the clamp by fastening the screws.



-  Do not use the bare wires if there is any visible damage.
-  Do not use SP-3, SPT-3 type wire
-  The screw torque of a cable clamp is 14.16 in-lbs (1.6 N·m).  
Do not over tighten the screws to prevent damage



## Power On/Off

### ■ Operations on Inverter

After proper battery and AC load connections, you can operate the inverter.

1. On the AC side, rock the ON/OFF Switch to the ON position.
2. The inverter is operating normally.

When finishing using the inverter, power off the AC loads first, and then rock the ON/OFF Switch to the OFF position.

-  When the inverter turns on, it is normal to see the fans run for a second and hear a beep.
-  Avoid powering on the inverter with the load (electronic devices) already switched on. This may trigger an overload since some electronic devices have an initial high power surge to start.
-  When switching off the inverter, turn off the electronic devices first. Although the inverter is off, the terminal capacitors will still have a charge, so the DC and AC terminals must be disconnected if altering the circuitry.

## ■ Wired Remote Control

The Wired Remote Control gives you the opportunity to power on/off the inverter from a distance (approximately 16.4 ft / 5 m).

Note that the inverter ON/OFF switch should be in the REM position.



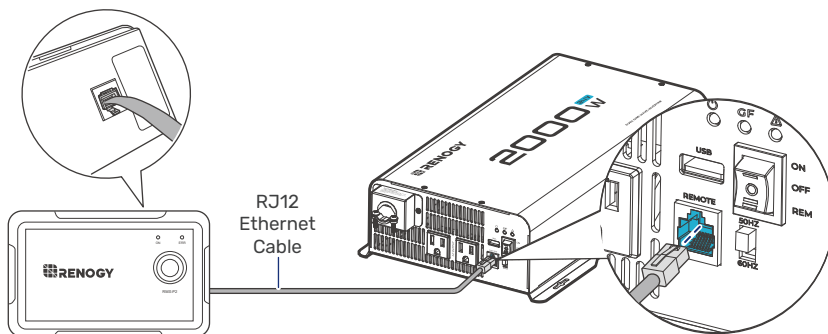

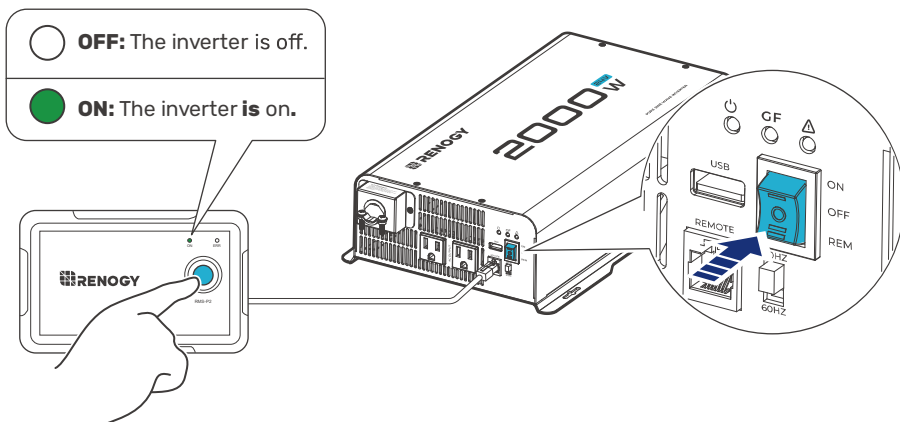

**Step 1:** Connect the Wired Remote Control to the inverter via the Remote Control Connector.



**Step 2:** Rock the ON/OFF Switch to the REM position, and you can power on/off the inverter via the Wired Remote Control.



## LED Overview & Troubleshooting

LED Status	Alarm	Protection & Alarm	Inverter Status
Fault LED in solid red  	Long steady beeping sound	Overtemperature protection	No output from the inverter.
		Undervoltage shutdown	No output from the inverter.
		Overload protection	No output from the inverter output side. After 5s, the inverter automatically restarts.
		Short circuit protection	After five times of failed restart, the inverter needs to be restored by manually turning it on.
Fault LED in Quick flashing  	Red LED Quick flashing	Input voltage is below 22.4V.	Keep input voltage above 22.4V.
		Input voltage is above 32.7V.	Keep input voltage below 32.7V.
Power LED in solid green and fault LED off!  	No sound	Inverter recovers output	Normal output from the inverter output side.
GFCI LED in solid yellow <b>GF</b> 	Long steady beeping sound	GFCI protection	1. No output from the inverter. 2. Disconnect all appliances, and use the ON/OFF/Remote switch to reset the inverter. Attempt to connect various appliances one at a time, observing if the yellow LED on the inverter remains illuminated. If it stays on, this suggests a current leakage issue with one of the appliances. If the LED remains on, kindly reach out to Renogy via <a href="https://www.renogy.com/contact-us">renogy.com/ contact-us</a> for further assistance.
	No sound and the inverter is off!	GFCI tripped	Disconnect appliances, and use the ON/OFF/Remote switch to reset the inverter.

 For further assistance, contact Renogy technical support service at [https:// www.renogy.com/contact-us](https://www.renogy.com/contact-us).

## Pure Sine Wave

The inverter outputs a pure sine wave similar to the waveform of the grid power. In a pure sine wave, the voltage rises and falls in a smooth fashion with very low harmonic distortion and cleaner utility-like power.

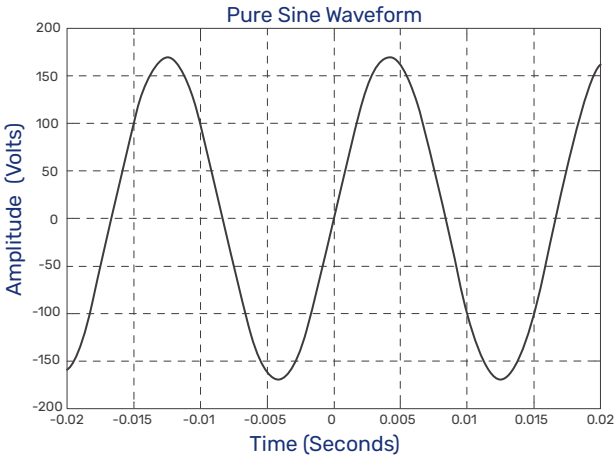

This technology allows the inverter to supply electronic devices that require a high quality waveform with little harmonic distortion. In addition, the technology enables the inverter to be more efficient than traditional ones, allowing you to use less energy to supply more devices. The inverter can provide sufficient, stable power for tools, fans, lights, computers, and other electronics without any interference.

## General Safety Information

### WARNING

- Have the inverter installed by a qualified technician in accordance with the local and national electric codes (NEC).
- There are no serviceable parts for this inverter. Do not disassemble or attempt to repair the inverter.
- Ensure all connections going into and from the inverter are tight. There may be sparks when making connections; therefore, there should not be flammable materials or gases near the installation site.
- The inverters are suitable for 24V battery banks ONLY.
- Always ensure the inverter is in OFF position and disconnect all AC and DC devices associated with the inverter.
- Never connect the AC output of the inverter directly to an Electrical Breaker Panel or Load Center which is also fed from the utility power or generator.
- Please confirm the polarity of the devices before connection. A reverse polarity contact can cause injury and damage the device.
- Be careful when touching bare terminals of capacitors as they may retain high lethal voltages even after power is removed.
- Do not let the positive (+) and negative (-) terminals of the battery touch each other. Use only deep-cycle sealed lead-acid, flooded, gel, or lithium batteries.
- Risk of explosion! Never install the inverter in a sealed enclosure with flooded batteries! Do not install in a confined area where battery gases can accumulate.

- Be careful when working with large lead acid batteries. Wear eye protection and have fresh water available in case there is contact with the battery acid.
- Overcharging and excessive gas precipitation may damage the battery plates and activate material shedding on them. Too high of an equalizing charge or too long of one may cause damage. Carefully review the requirements of the specific battery in use.

#### **VORSICHT**

- Install the inverter in a well-ventilated, cool, and dry environment. Make sure the fans of the inverter and the ventilation holes are not blocked.
- Do not expose the unit to rain, moisture, snow, or liquids of any type.

## Specifications

General Data	
<b>Model</b>	RIV2420P2-12S
<b>Output Waveform</b>	Pure Sine Wave
<b>AC Terminals</b>	2x AC Socket & Terminal Block
<b>DC Terminals</b>	M8 x 25 mm
<b>Operating Temperature</b>	-4°F to 131°F / -20°C to 55°C
<b>Storage Temperature</b>	-40°F to 158°F / -40°C to 70°C
<b>Humidity</b>	Max 95%, non-condensing
<b>Cooling</b>	Thermally Controlled Fans
<b>Dimensions (L x W x H)</b>	16.93 x 8.99 x 3.75 in 430.3 x 228.4 x 95.3 mm
<b>Weight</b>	10.14lb / 4,6 Kg
Electrical Data	
<b>Continuous Output Power</b>	2000W
<b>Continuous Output Current</b>	16.7AAC
<b>Total Harmonic Distortion (THD)</b>	< 3%
<b>Power Factor</b>	1
<b>Surge Rating</b>	4000W (@2S)
<b>Output Voltage</b>	120V AC
<b>Output Frequency</b>	50Hz / 60Hz
<b>Rated Battery Input Voltage</b>	24V DC
<b>Battery Input Voltage Range</b>	23V to 30.7V DC
<b>Maximum Continuous Battery Output Current</b>	106A
<b>Inverter Efficiency</b>	Max. 92%
<b>Full Load Efficiency</b>	89%
<b>Power Consumption</b>	< 19.2W
<b>Battery Overvoltage Shutdown</b>	33.3 V (±0.5 V) DC
<b>Battery Low Voltage Alarm</b>	22.4 V (±0.5 V) DC
<b>Battery Low Voltage Shutdown</b>	21.8 V (±0.5 V) DC

Wired Remote Data	
Front Plate Dimensions	2.8 x 4.3 x 1.3 in / 70 x 110 x 31.8 mm
Wired Length	16.4 ft / 5 m

## Renogy Support

To discuss inaccuracies or omissions in this quick guide or user manual, visit or contact us at:

[G | renogy.com/support/downloads](https://renogy.com/support/downloads)

 [contentservice@renogy.com](mailto:contentservice@renogy.com)



Questionnaire Investigation



To explore more possibilities of solar systems, visit Renogy Learning Center at:

[G | renogy.com/learning-center](https://renogy.com/learning-center)

For technical questions about your product in the U.S., contact the Renogy technical support team through:

[G | renogy.com/contact-us](https://renogy.com/contact-us)

 1(909)2877111

For technical support outside the U.S., visit the local website below:

**Canada** |  [ca.renogy.com](https://ca.renogy.com)

**China** |  [www.renogy.cn](https://www.renogy.cn)

**Australia** |  [au.renogy.com](https://au.renogy.com)

**Japan** |  [renogy.jp](https://renogy.jp)

**South Korea** |  [kr.renogy.com](https://kr.renogy.com)

**Germany** |  [de.renogy.com](https://de.renogy.com)

**United Kingdom** |  [uk.renogy.com](https://uk.renogy.com)

**Other Europe** |  [eu.renogy.com](https://eu.renogy.com)



## Renogy Empowered

Renogy aims to empower people around the world through education and distribution of DIY-friendly renewable energy solutions.

We intend to be a driving force for sustainable living and energy independence.

In support of this effort, our range of solar products makes it possible for you to minimize your carbon footprint by reducing the need for grid power.



## Live Sustainably with Renogy

Did you know? In a given month, a 1 kW solar energy system will...



Save 170 pounds of coal from being burned



Save 300 pounds of CO<sub>2</sub> from being released into the atmosphere



Save 105 gallons of water from being consumed



## Renogy Power

PLUS

Renogy Power Plus allows you to stay in the loop with upcoming solar energy innovations, share your experiences with your solar energy journey, and connect with like-minded people who are changing the world in the Renogy Power Plus community.



@Renogy Solar



@renogyofficial



@Renogy

Renogy reserves the right to change the contents of this manual without notice.



RENOGY.COM

 **RENOGY**

## 技术要求

印刷颜色：彩印  
要求：快装页面上下左右需要留好出血  
印刷方式：双面印刷  
装订：骑马钉  
说明书大小：A5  
纸张重量：157g  
材质：铜版纸