

## AT A GLANCE (Model: T85F0)

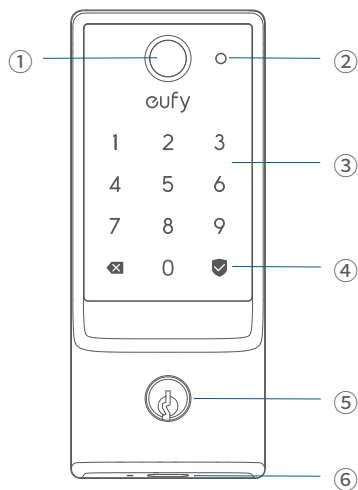

- ① **Fingerprint Button**
  - Use to lock and unlock the door.
- ② **Battery Indicator**
- ③ **Keypad**
- ④ **Status Light and Lock / Unlock Button**
  - Blue: Door unlocked
  - Orange: Door locked
  - Red: Abnormal state
- ⑤ **Keyway**
  - Can be copied, can't be rekeyed.
- ⑥ **USB-C Port**
  - Charges the lock in emergency situations.

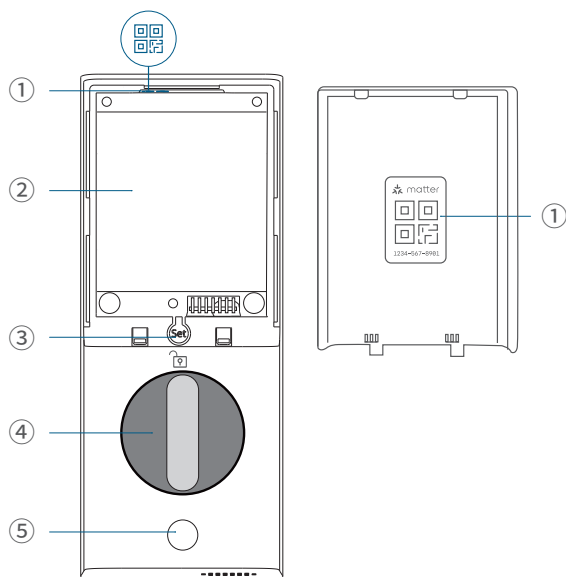

- ① **Matter QR Code\***
  - Scan to add the Smart Lock E31 in the corresponding app (See "SETTING UP THE SYSTEM").
- ② **Battery Compartment**
- ③ **Set Button**
  - Pair: Press and hold for 2 seconds.
  - Reset: Press and hold for 10 seconds.
  - Recalibrate: Press 5 times in a row.
- ④ **Thumbturn**
- ⑤ **Screw Hole**

## INSTALLATION

### What You Need

Prepare a standard Phillips screwdriver before installation. The included screws are Phillips screws.

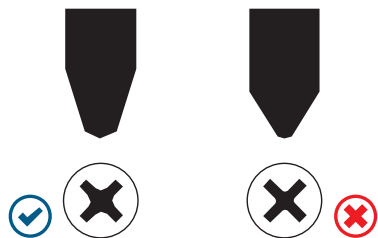

### What's in the Box

Step 2. Deadbolt Installation Set

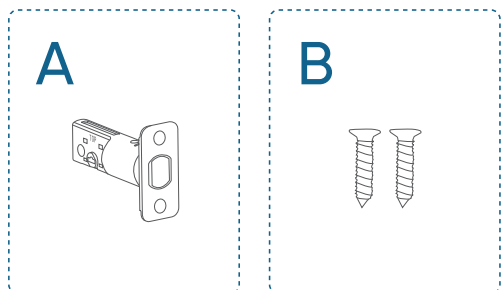

### Step 3. Exterior Assembly

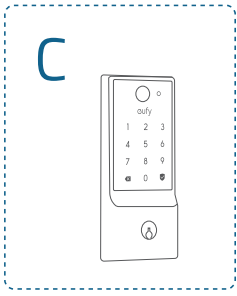

### Step 4. Interior Assembly Installation Set

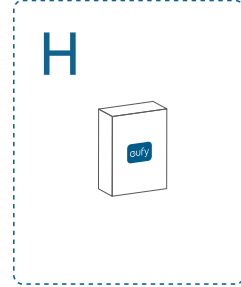
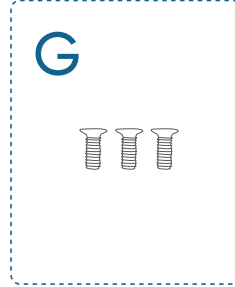
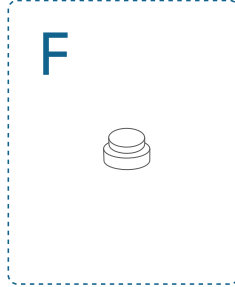
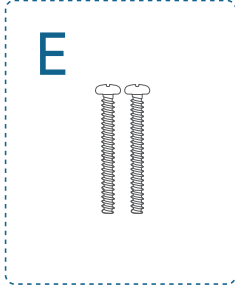
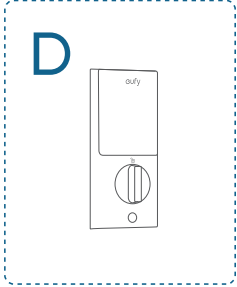

### Step 5. Strike Plate Installation Set

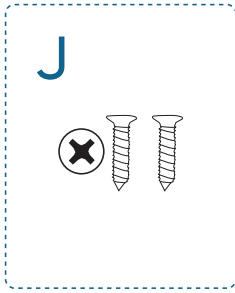
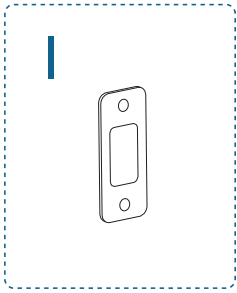

### Step 1 Prepare the Door

1. Remove the existing lock and check your door.
2. Check if your door has holes like the one below. Standard US doors are already compatible.

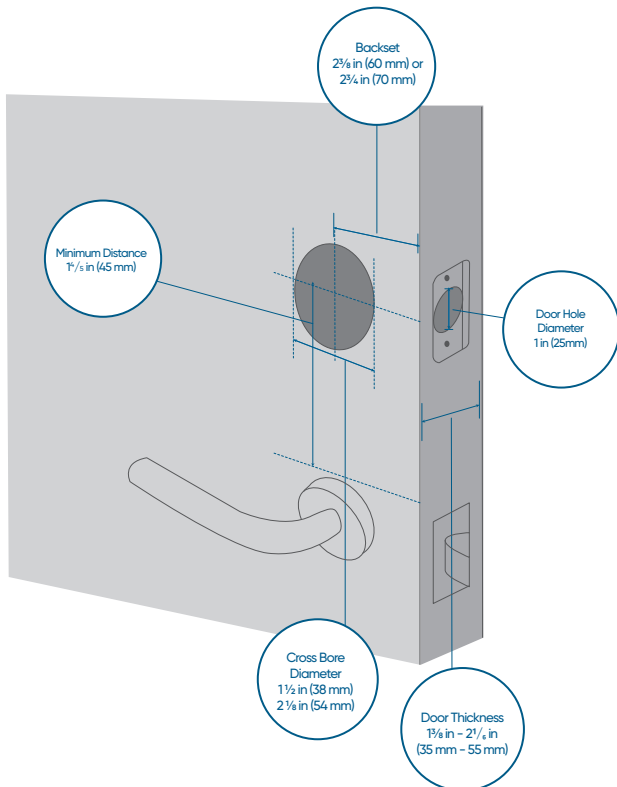

If not, follow the template to drill holes on your door.

## Step 2 Install Deadbolt

1. Check your door to see if the deadbolt requires adjustment.

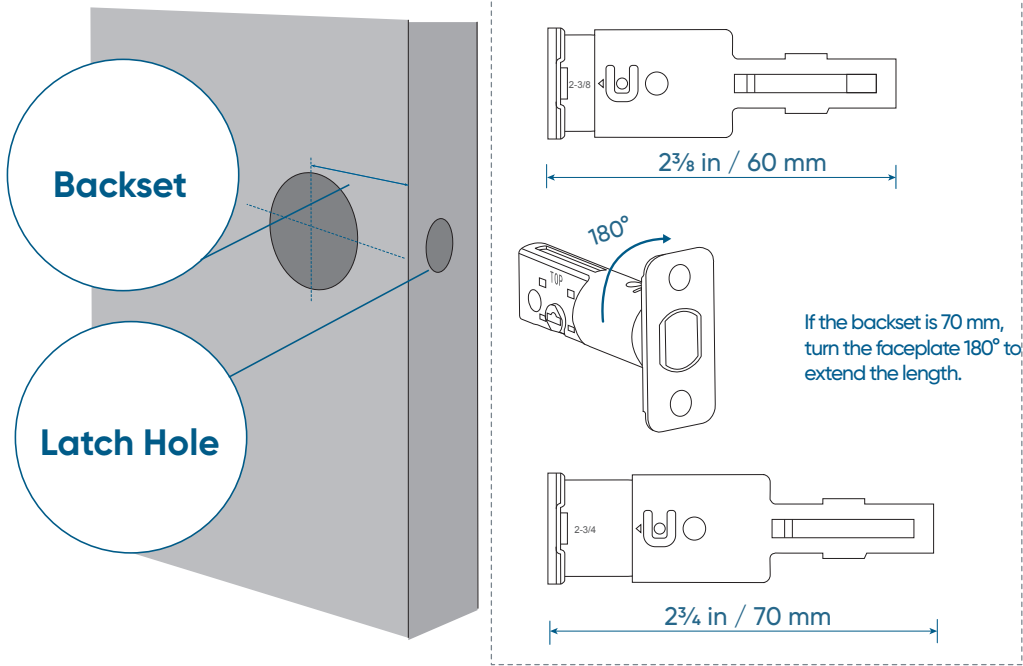

2. Insert and screw the deadbolt into the doorframe.

\*Check the latch recess before inserting the deadbolt.  
If the latch recess is round, refer to diagram A.  
If the latch recess is rectangular, refer to diagram B.

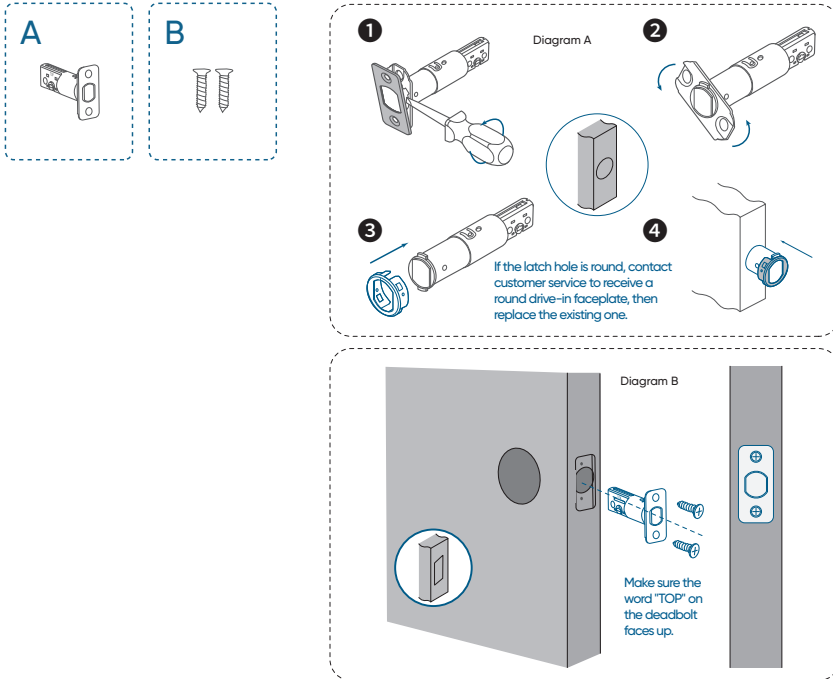

• If your faceplate recess is round-shaped, contact eufy Customer Service for a rounded faceplate.

### Step 3 Install Exterior Assembly

1. If the cross bore diameter of your door is 38 mm, remove the spacer before installation.

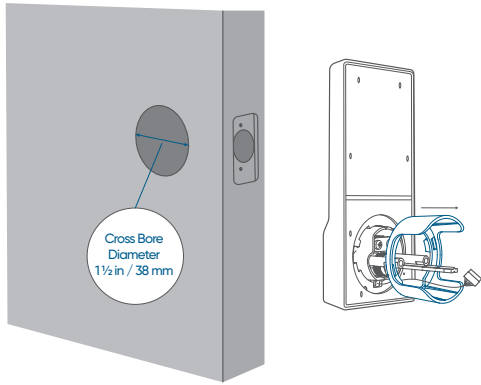

2. Make sure the cable goes underneath the deadbolt.

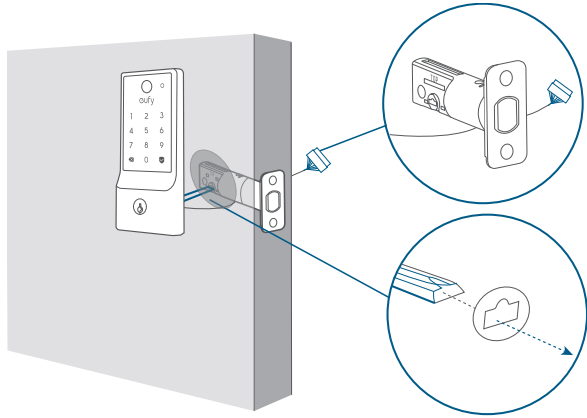

### Step 4 Install Interior Assembly

1. Detach the mounting plate and battery cover from the interior assembly.

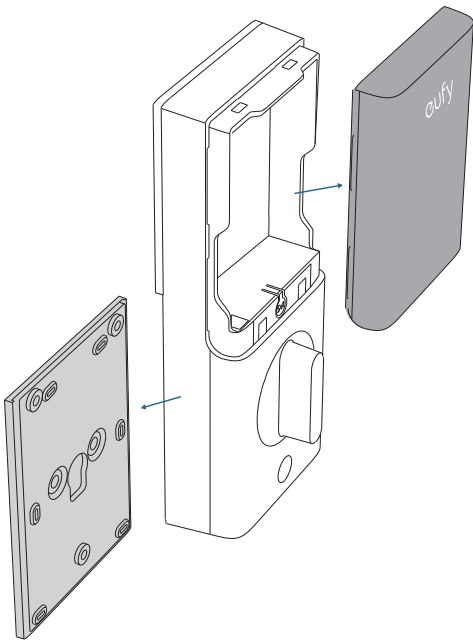

2. Run the cables through the slot on the mounting plate. Make sure the silicone pad is against the door.

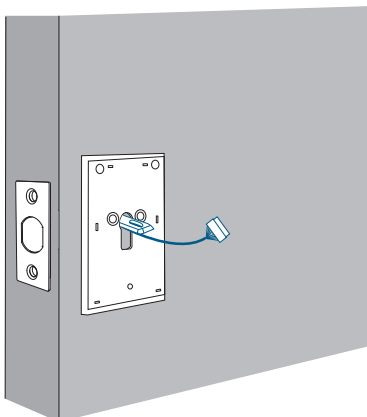

3. Attach the side with the silicone pad to the door, and secure the mounting plate with screws.

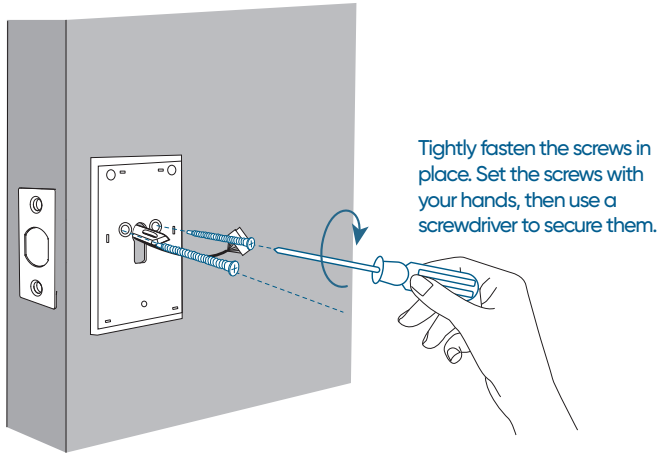
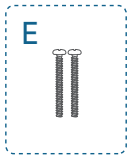

Tightly fasten the screws in place. Set the screws with your hands, then use a screwdriver to secure them.

4. Plug the power cable into the sockets on the back of the interior assembly. Route the cables around the tailpiece receiver to avoid pinching during installation.

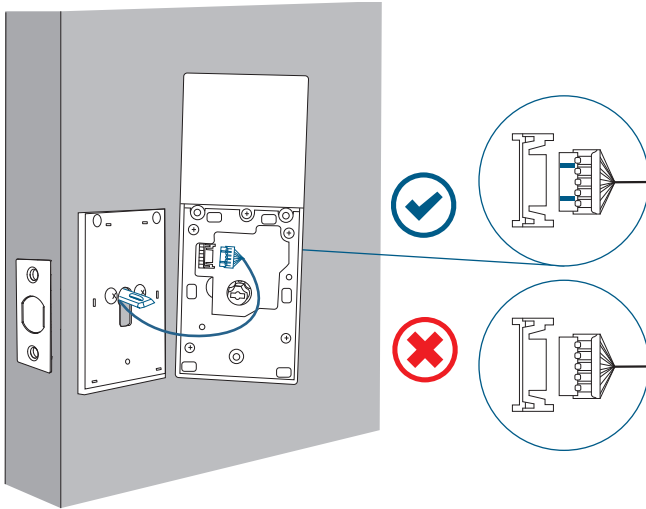

5. Insert the T-shaped tailpiece of the exterior keypad into the T-shaped tailpiece receiver of the interior assembly. Make sure the wire is tucked into the cavity on the back of the interior assembly.

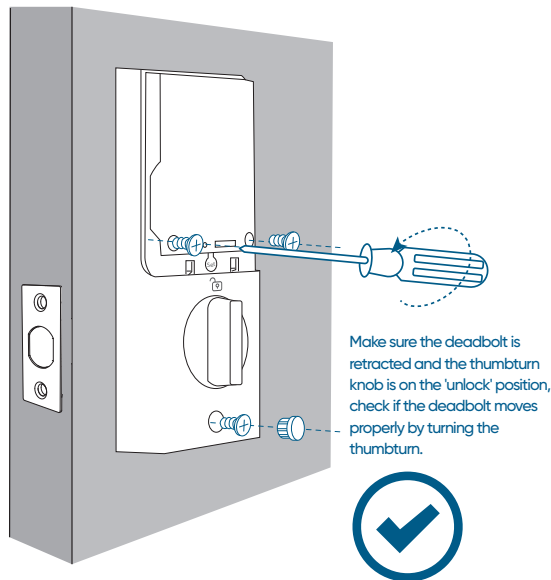
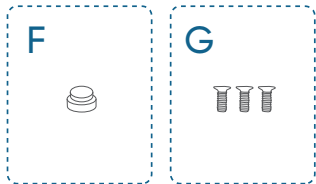

Make sure the deadbolt is retracted and the thumbturn knob is on the 'unlock' position, check if the deadbolt moves properly by turning the thumbturn.

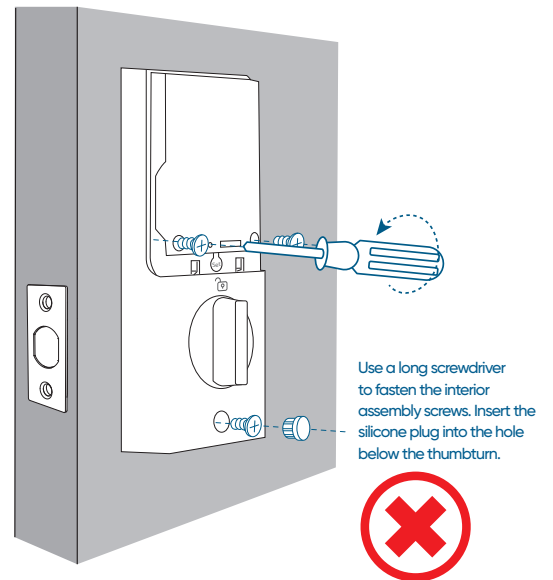

Use a long screwdriver to fasten the interior assembly screws. Insert the silicone plug into the hole below the thumbturn.

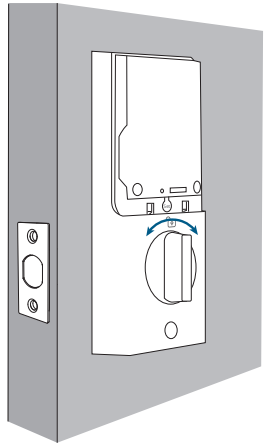
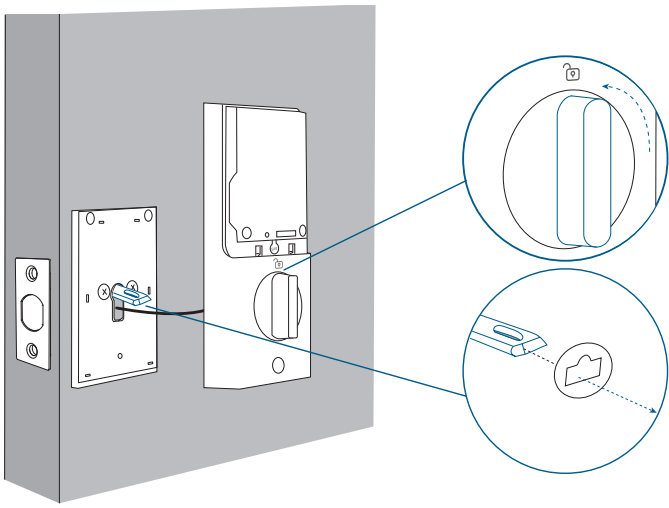

Make sure the deadbolt is retracted and the thumb turn knob is on the 'unlock' position, check if the deadbolt moves properly by turning the thumbturn.

6. Install the battery pack with the correct polarity. Don't put on the cover until the system setup is done in the app.

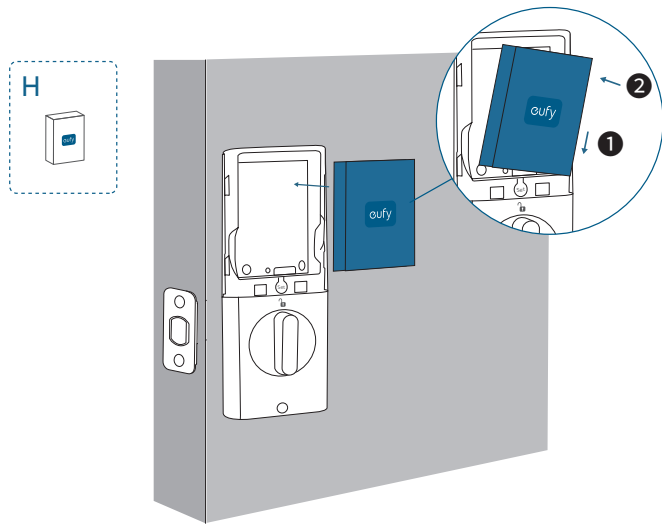

## Step 5 Install Strike Plate

Make sure the depth of the latch hole on the door frame is deep enough (1" / 25.4 mm), otherwise the calibration might fail during the setup.

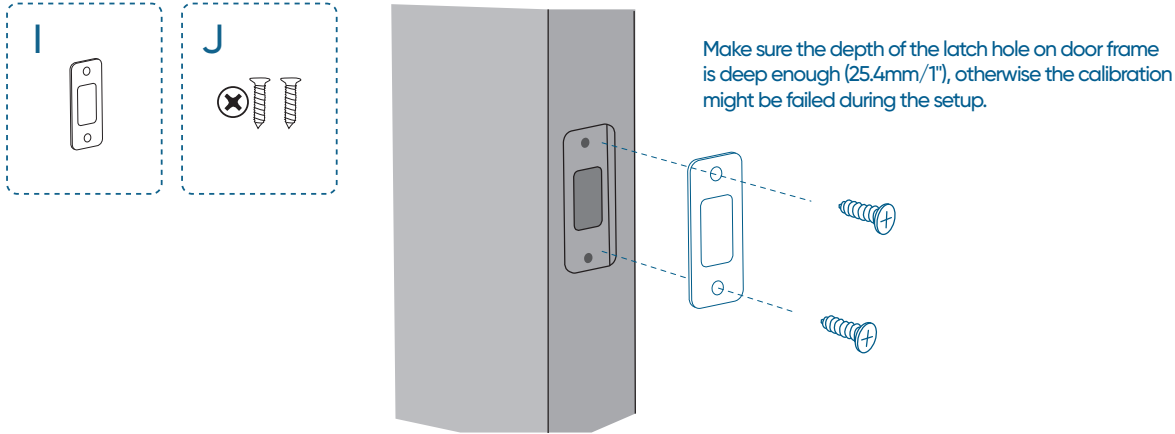

## SETTING UP THE SYSTEM

1. Download and install the eufy Security app, then sign up for an account.



2. Follow the in-app instructions to add the Smart Lock E31 to your device list.

- Please visit <https://support.eufylife.com/s/> for more information.

3. This smart lock is Matter-compatible, enabling seamless integration with Apple Home, SmartThings, Alexa, and Google-enabled devices in your home. To set it up, use the eufy app and navigate to Device >> Settings >> Work with Matter to pair with the third-party ecosystems.

- Scan this QR code to read the Matter device setup guide and set up the device in the corresponding app.

