

Rinnai

Operation Manual

Split Type Wall Mounted Air Conditioner
Models: RINV25RC / RINV34RC / RIN51RC / RINV70RC

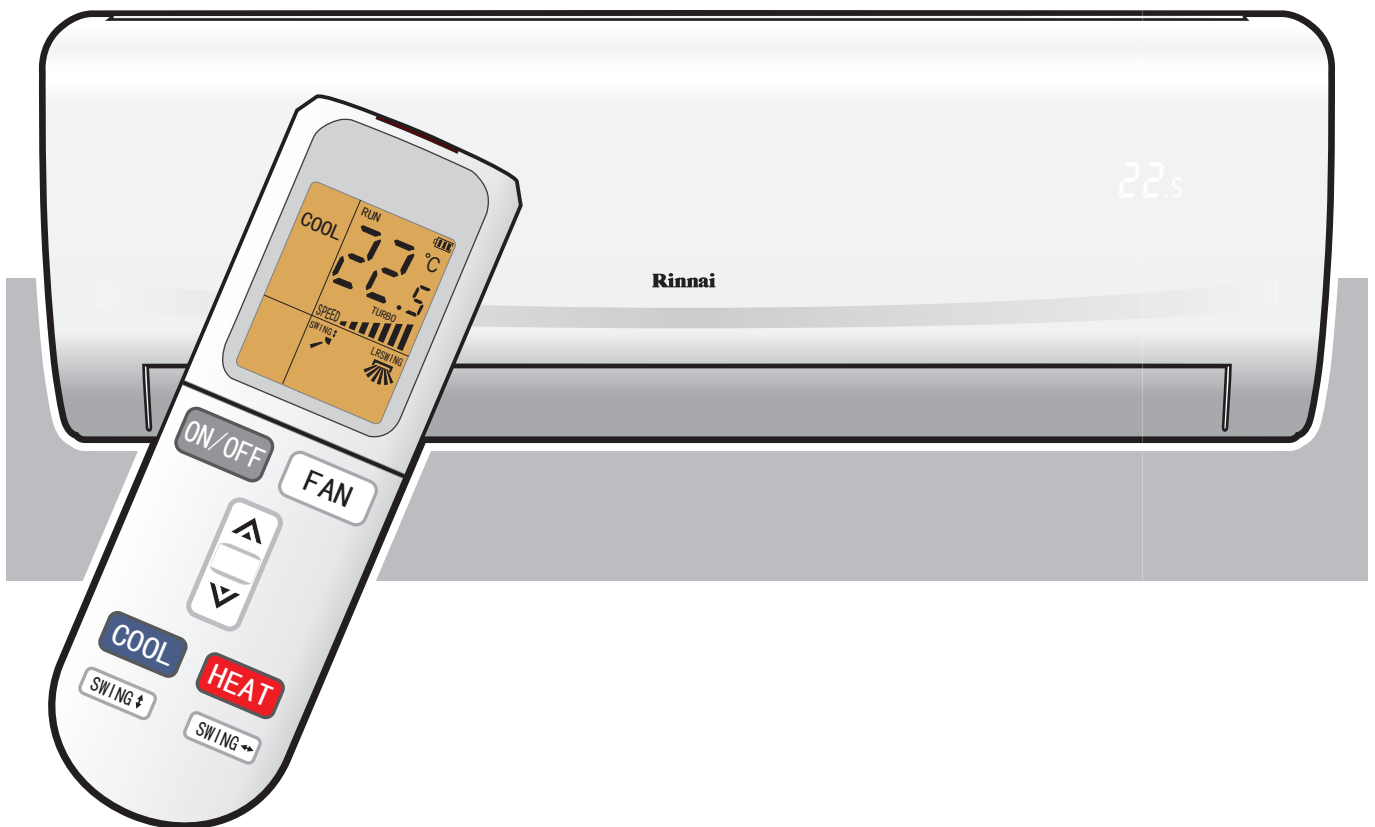

This appliance shall be installed in accordance with:

- Manufacturer's Installation Instructions
- Current AS/NZS 3000
- Local Regulations and Municipal Building Codes including local OH&S requirements

This appliance must be installed, maintained and removed by an Authorised Person.

For continued safety of this appliance it must be installed and maintained in accordance with the manufacturers instructions.



N10378

TABLE OF CONTENTS

Warnings and Important Information	3
Air Conditioner Basics	5
Appliance Components	5
Remote Control Batteries	5
Remote Control Cradle	5
Controller Operating Basics	5
Remote Control Layout	6
Basic Operation	7
On	7
Off	7
Cooling	7
Heating	7
Fan Speed	7
Adjusting Vertical air flow	8
Adjusting Horizontal air flow	8
Advanced Operation	9
Auto Mode	9
Dry (Dehumidifying) Mode	9
Fan Only Mode	9
Turbo	10
Quiet	10
Health (Wi-Fi)	10
Sleep Mode	10
Delay On Timer	11
Delay Off Timer	11
Cancelling ON/OFF timers	11
Room Temperature Display	11
Large Temperature Display	12
Auto Fresh	12
Spot Swing	12
Economy (cooling Only)	12
Cleaning Operation	13
Operating The Air Conditioner Without The Remote Control	13
Power Interruption Automatic Restart	13
Care & Maintenance	14
General Maintenance	14
Cleaning the air filter	14
Save A Service Call	15
When to Call for Service	15
Warranty	16
Installation Record	19
Installer Details	19
System Details	19
Contacts	20



WARNINGS AND IMPORTANT INFORMATION



READ ALL INSTRUCTIONS BEFORE USING THE APPLIANCE.

Always comply with the following precautions to avoid dangerous situations and to ensure optimum performance.

Failure to carefully read and follow all instructions in this manual can result in equipment malfunction, property damage, personal injury and/or death.

WARNINGS: WHEN IGNORED, CAN RESULT IN SERIOUS INJURY OR DEATH.

CAUTIONS: WHEN IGNORED, CAN RESULT IN MINOR INJURY OR PRODUCT DAMAGE.



REGULATORY / INSTALLATION

This appliance shall be installed in accordance with:

Manufacturer's Installation Instructions.

Current AS/NZS 3000.

Local Regulations and Municipal Building Codes including local OH&S requirements.

This appliance must be installed, maintained and removed by an Authorised Person.

For continued safety of this appliance it must be installed and maintained in accordance with the manufacturers instructions.

This appliance uses R410A refrigerant.

This appliance is heavy, use 2 people or mechanical lifting device. Improper lifting may result in serious injury.

Take care when opening or unpacking this appliance. Failure to do so may result in serious injury or product failure.

DO NOT modify the electrical wiring of this appliance. If the control power wiring is damaged or deteriorated then it must be replaced by an authorized person. Failure to do so may result in electric shock, fire, serious injury or product failure.

DO NOT install the air conditioner on an unstable or non level surface or where there may be a danger of it falling. It may result in death, serious injury, or product failure.

DO NOT install the outdoor unit where noise may cause nuisance.

DO NOT install the outdoor unit where it will be exposed to sea wind (salt spray) as this will reduce durability.

OPERATION RANGE LIMITATIONS

The table below indicates the temperature ranges the air conditioner can be operated within.

MODE	TEMPERATURE SOURCE	MINIMUM OPERATION TEMPERATURE	MAXIMUM OPERATION TEMPERATURE
Cooling / Heating	Adjustable inside temperature	16°C	32°C
	Ambient outside temperature	-12°C	47°C

**OPERATION**

DO NOT let the air conditioner run for extended periods when the humidity is very high or when doors or windows are left open. As this may result in an excessive operational loading and lead to product failure.

DO NOT cover or place articles on any part of this appliance.

DO NOT touch, operate or clean the air conditioner with wet hands. It may result in electric shock or product failure.

DO NOT insert hands or other objects through the air inlet or outlet while the appliance. It may result in electric shock or product failure.

DO NOT place a heater or other heating appliances near this appliance, always ensure sufficient ventilation when using this appliance and a heating appliance at the same time. Failure to do so may result in product miss-operation.

Turn main power off before cleaning. Failure to do so may result in fire, electric shock, or product failure.

DO NOT use solvents, abrasives or harsh detergent to clean any part or surface of this appliance or spray water or allow liquids to enter the indoor unit. The enclosure of the appliance and remote control can be cleaned using a soft, damp cloth and a mild detergent.

NEVER touch the metal parts of the air conditioner when you remove the air filter. It may result in electric shock or product failure.

DO NOT leave flammable materials near the appliance. It may result in explosion or fire.

If there is excessive noise, smell or smoke coming from the appliance, turn the appliance **OFF**, isolate the power supply and contact a service agent.

DO NOT operate the appliance if it has been submerged into water due to flooding, contact a service agent. Failure to do so may result in electric shock, fire, serious injury, or product failure.

This appliance is **NOT** intended for use by persons (including children) with reduced physical, sensory or mental capabilities, or lack of experience and knowledge unless they have been given supervision or instruction concerning use of the appliance by a person responsible for their safety.

Children should be supervised to ensure that they do not play with the appliance.

The air conditioning system is designed to achieve consumer comfort. It is not designed for commercial applications required a controlled atmosphere (i.e. computer rooms, food preservation, etc.)

DO NOT block the inlet or outlet of air flow. It may result product failure.

DO NOT drink the condensate water drained from the appliance. This condensate is not potable and may present a health risk if consumed.

DO NOT expose people, animals or plants directly to the cold or hot discharge of the appliance. It may result in serious injury.

DO NOT mix the batteries for the remote control with other types of batteries or mix new batteries with used batteries. Failure to do so may result in product failure. **STOP** using the remote control if there is a battery fluid leak.

AIR CONDITIONER BASICS

APPLIANCE COMPONENTS

1. Indoor unit air inlet
2. Filter (located behind front access panel)
3. Manual ON/OFF (Auto) override button (located behind front access panel)
4. Indoor unit air outlet (with louvres and vanes for setting air flow direction)
5. Remote control
6. Signal receiver window and set temperature display (the display is built into the front access panel)
7. Refrigerant pipes, electrical cable(s) (covered with binding tape)
8. Condensate drain hose (covered with binding tape)
9. Refrigerant entry (for service and installer use only)
10. Outdoor unit air inlet (on rear & left side of unit)
11. Outdoor unit air discharge and protective grille (on front of unit)

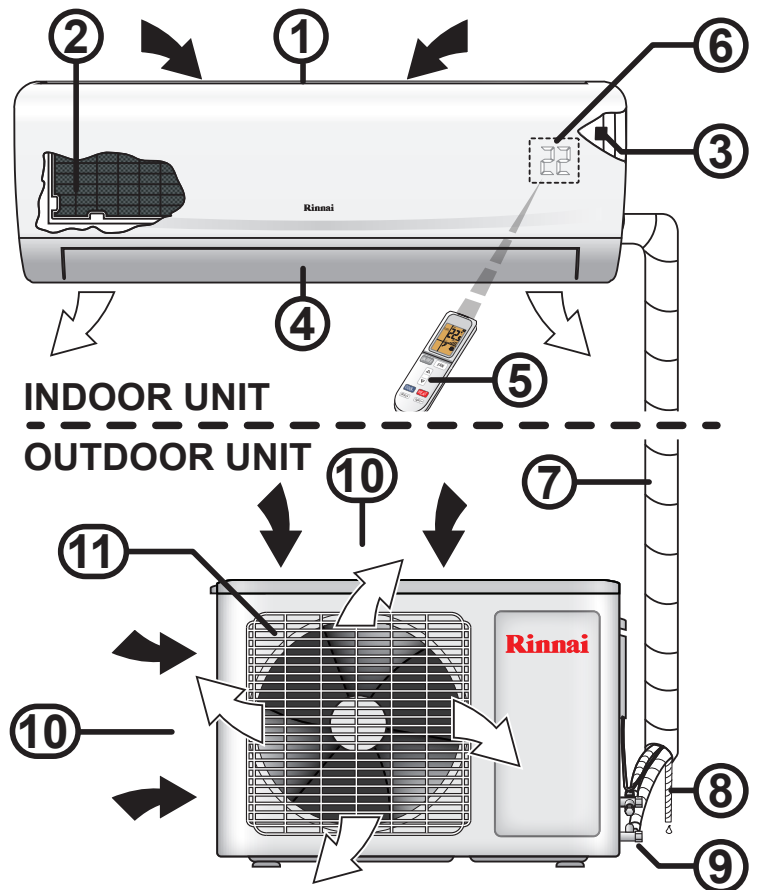

REMOTE CONTROL BATTERIES

Insert batteries before using the remote control. The battery type used is AAA (1.5 V).

1. Remove the battery cover at the rear of the remote control.
2. Insert the new batteries and make sure that the + and - terminals of the batteries are installed correctly.
3. Reattach the battery cover.



If the LCD screen of the remote control starts to fade or fails to transmit, replace the batteries.

REMOTE CONTROL CRADLE

For convenience a slide-in cradle is provided for fixing the remote control to a wall.



To Install:

Choose a safe and easily-accessible place. **DO NOT** mount the cradle in direct sunlight as this may damage the controller.

Fix the cradle to the wall using the holes provided using 2 screws.

CONTROLLER OPERATING BASICS

Point the remote control towards the signal receiver at the bottom of the air conditioner to operate it.



The remote control may operate other electronic devices if pointed towards them. Make sure to point the remote control towards the signal receiver of the air conditioner.

For proper operation, use a soft cloth to clean the signal transmitter LED and the receiver window.

REMOTE CONTROL LAYOUT

The external buttons are for basic operations, the buttons located behind the door are for advanced operations.

1. **ON / OFF button**
Turns the power on/off.
2. **FAN speed button**
Adjusts the fan speed: AUTO / LOW /MEDIUM / HIGH.
3. **Temperature adjustment buttons**
Adjusts room temperature when cooling and heating.
4. **COOL**
One touch cooling operation.
5. **HEAT**
One touch heating operation.
6. **SWING↓ button (vertical)**
Adjusts the air flow direction vertically.
7. **SWING↔ button (horizontal)**
Adjusts the air flow direction horizontally.
8. **Operation MODE selection button**
Selects the operation mode: AUTO / COOLING / DRY (dehumidifying) / HEATING / FAN (fan only).
9. **TURBO cooling / heating button**
Warms or cools rooms at the fastest rate.
10. **HEALTH button**
Used to access Wi-Fi operation.
11. **QUIET button**
Sets appliance operation to lowest noise output level.
12. **SLEEP button**
Sets the sleep mode auto operation.
13. **TIMER button**
Sets the count down timer to turn the power ON / OFF.
14. **ROOM°C Temperature display button**
Displays the temperatures: ROOM / SET.
15. **DISPLAY button**
Turns indoor temperature display ON / OFF.
16. **FRESH button**
Keeps the head unit free of excess moisture by running a 3 min cycle every time the unit is turned off.
17. **CLEAN button**
End of season cleaning process to dry the inside of the indoor unit or when the appliance is not going to be used for an extended period of time.
18. **SPOT SWING button**
Sets a fixed direction for air flow horizontally.
19. **ECO button**
Sets appliance to the most efficient operation.
20. **Wireless Transmitter LED**
21. **LCD screen**
Displays settings and operation modes.
22. **Blank buttons**
Not used.

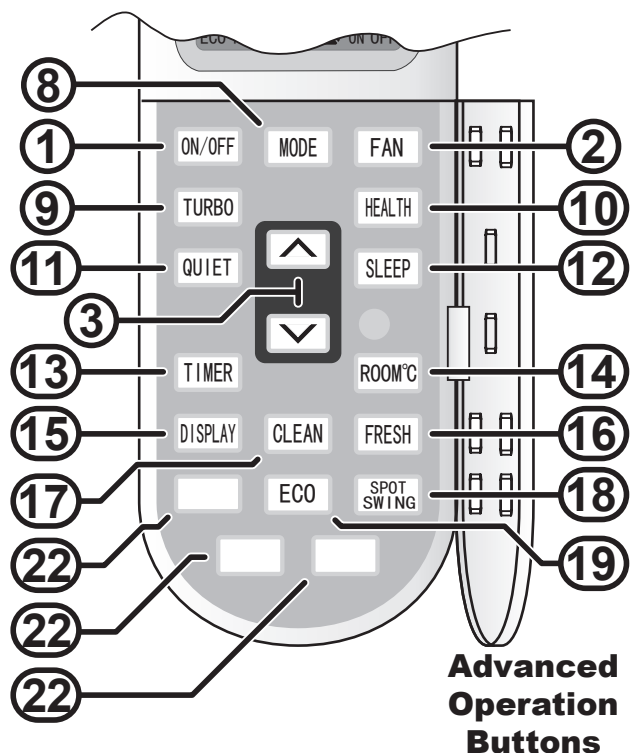
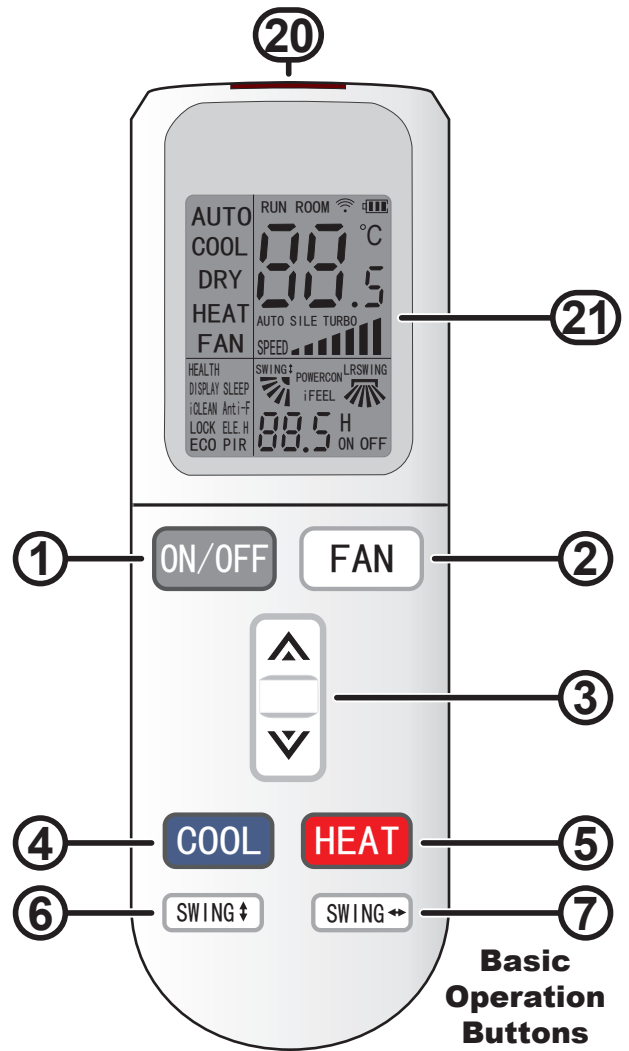

BASIC OPERATION

BASIC OPERATION BUTTONS

The external buttons are for basic operations, the buttons located behind the door are for advanced operations.

ON

When the appliance is off (standby):

1. Press the "ON/OFF" button to turn on appliance. The appliance will begin to operate.

All current operational settings, modes and the battery status are shown on the LCD screen.

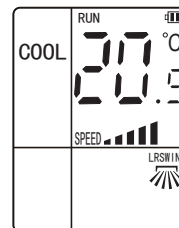

When the appliance is turned on via the "ON/OFF" button it will return to operation using the last operational settings and modes that were set.

OFF

When the appliance is running:

1. Press the "ON/OFF" button to turn off appliance. The appliance will be placed into standby.

The previous operation mode and the remote control battery status are shown on the LCD screen.

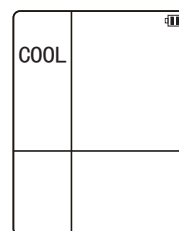

When the appliance is turned off via the "ON/OFF" button it will retain the last operational settings and modes that were in use and be placed into standby.

COOLING

When selected this mode operates the air conditioner as a cooling appliance.

1. Press the "COOL" button.
2. Press \blacktriangle or \blacktriangledown to set the desired temperature (the available temperature range is 16°C ~ 32°C in 0.5°C increments).

The fan speed defaults to that which was last used (see FAN SPEED below).

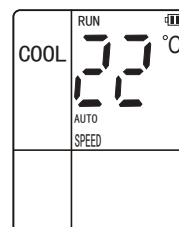

HEATING

When selected this mode operates the air conditioner as a heating appliance.

1. Press the "Heat" button.
2. Press \blacktriangle or \blacktriangledown to set the desired temperature (the available temperature range is 16°C ~ 32°C in 0.5°C increments)).

The fan speed defaults to that which was last used (see FAN SPEED below).

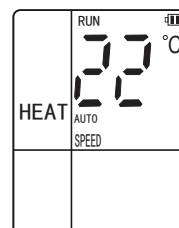

Refer to page 4 for the operational temperature range of the appliance when using for both cooling and heating.

FAN SPEED

The fan speed can be adjusted manually or set to automatic.

1. Press the "FAN" button until the desired fan speed is shown on the LCD screen (displayed below the temperature display), the available fan speeds are AUTO / low (2 bars) / medium (4 bars) / high (6 bars).

Select "AUTO" if you wish the fan speed to be adjusted automatically by the appliance.

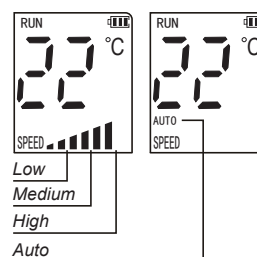

ADJUSTING VERTICAL AIR FLOW

Continuous Circulation

1. To adjust the direction of the air flow vertically for an even air circulation, press the "SWING↑" button, this activates a continuous cyclic movement of the louvre. When cycling, "SWING↑" and the swing icon are shown on the LCD screen.

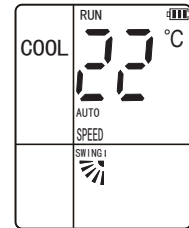

Fixed Direction

1. To adjust the direction of the air flow vertically in a fixed direction, press the "SWING↑" button once to activate a continuous cyclic movement of the louvre. "SWING↑" and the swing icon are shown on the LCD screen.
2. When the desired flow direction has been reached press the "SWING↑" button again to stop the movement of the louvre. "SWING↑" and the swing icon are no longer shown on the LCD screen.
3. Repeat the above steps to further adjust the flow direction or press the "SWING↑" button once to return to a continuous cyclic movement of the louvre. When cycling, "SWING↑" and the swing icon are shown on the LCD screen.



DO NOT attempt to adjust the air deflector louvre manually as this can result in damage to the louvre movement mechanisms.

ADJUSTING HORIZONTAL AIR FLOW

Continuous Circulation

1. To adjust the direction of the air flow horizontally for an even air circulation, press the "SWING↔" button to enable a continuous cyclic movement of the vanes. When cycling, "L R SWING" and the swing icon are shown on the LCD screen.

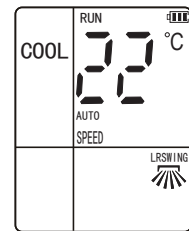

Fixed Direction

1. To adjust the direction of the air flow vertically in a fixed direction, press the "SWING↔" button once to enable a continuous cyclic movement of the vanes. "L R SWING" and the swing icon are shown on the LCD screen.
2. When the desired flow direction has been reached press the "SWING↔" button again to stop the movement of the vanes. "SWING↔" and the swing icon are no longer shown on the LCD screen.
3. Repeat the above steps to further adjust the flow direction or press the "SWING↔" button once to a return to a continuous cyclic movement of the vanes. When cycling, "SWING↔" and the swing icon are shown on the LCD screen.



DO NOT attempt to adjust the air deflector vanes manually as this can result in damage to the louvre movement mechanisms.

ADVANCED OPERATION

ADVANCED OPERATION BUTTONS

The external buttons are for basic operations, the buttons located behind the door are for advanced operations, when the door is opened the basic operation buttons are de-activated until the door is again closed.

ON/OFF BUTTON (Functions the same as the "ON/OFF" button in basic operation on page 7).

FAN BUTTON (Functions the same as the "FAN" button in basic operation on page 7).

MODE - AUTO

In this mode, the fan speed, heating / cooling and the temperature are all adjusted automatically by the appliance, based on the current room temperature.

1. Press the "ON/OFF" button to turn on appliance.
2. Press the "MODE" button until "AUTO" is shown on the LCD screen.
3. To cancel the "AUTO" mode and return the appliance to manual control select another mode.

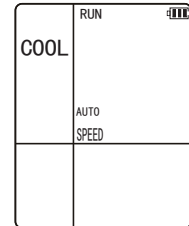

The table below describes the relationship between room temperature and modes of operation when set to Auto.

Room Temperature	Set Temperature	Operation Mode
$\geq 27^{\circ}\text{C}$	24°C	Cooling Mode
$20^{\circ}\text{C} \sim 27^{\circ}\text{C}$	24°C	Dry Mode
$\leq 20^{\circ}\text{C}$	24°C	Heating Mode



In this mode, you cannot adjust the temperature, however the swing operations for air direction and the fan speeds can still be adjusted.

MODE - COOL (Functions the same as the "COOL" button in basic operation on page 7).

MODE - DRY (DEHUMIDIFYING)

In periods of high humidity this mode removes excess moisture from the room, in order to prevent mould and mildew. This mode adjusts the room temperature and the fan speed automatically to maintain the optimal level of humidity.

1. Press the "ON/OFF" button to turn on appliance.
2. Press the "MODE" button until "DRY" is shown on the LCD screen.

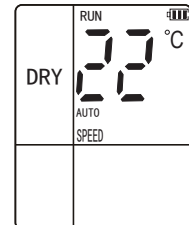

In this mode changes to the room temperature or fan speed are not applied as the appliance will automatically adjust both room temperature or fan speed to maintain the optimal level of humidity.

MODE - HEAT (Functions the same as the "HEAT" button in basic operation on page 7)

MODE - FAN ONLY

This mode uses the fan to circulate room air without changing the room temperature.

1. Press the "ON/OFF" button to turn on appliance.
2. Press the "MODE" button until "FAN" is shown on the LCD screen.
3. Press the "SPEED" button until the desired speed is shown on the LCD screen (the available fan speeds are low (2 bars) / medium (4 bars) / high (6 bars)).

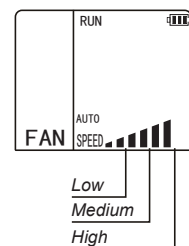

In this mode, Swing operations for air direction can still be adjusted, however the AUTO setting for the fan speed is not available.

TURBO

This mode allows you to cool indoor air quickly in summer or warm it quickly in winter.

1. Press the "ON/OFF" button to turn on appliance.
2. Confirm that either "COOL" or "HEAT" modes are selected as shown on the LCD screen.
3. Press the "TURBO" button, "TURBO" is shown on the LCD screen and an addition fan speed bar is also displayed.

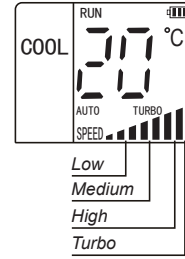

NOTE When the appliance is operating in AUTO, FAN or DRY modes the Turbo function is not available. In turbo mode the fan is set to operate at the maximum output. Attempting to alter the fan speed during TURBO mode operation will cancel this mode and return the appliance to manual operation.

QUIET

This mode operates the appliance at it's quietest, ideal for when minimal noise levels are desired.

1. Press the "ON/OFF" button to turn on appliance.
2. Confirm that either "COOL" or "HEAT" modes are selected as shown on the LCD screen.
3. Press the "QUIET" button, "SILE" is shown on the LCD screen and a single fan speed bar is also displayed.

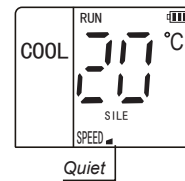

NOTE Attempting to alter the fan speed during Quiet mode operation will cancel this mode and return the appliance to manual operation.

HEALTH (WI-FI)

When pressed 8 times in quick succession, this button activates and or resets the Wi-Fi module of the appliance.

The appliance will respond with a double beep to confirm Wi-Fi activation or reset. For further details refer to the Rinnai web site: <http://www.rinnai.com.au/cooling/>

SLEEP MODE

1. Press the "ON/OFF" button to turn on appliance.
2. Set the desired mode, temperature and fan setting as per basic operations.
3. Press the "SLEEP" button, "SLEEP" is shown on the LCD screen:

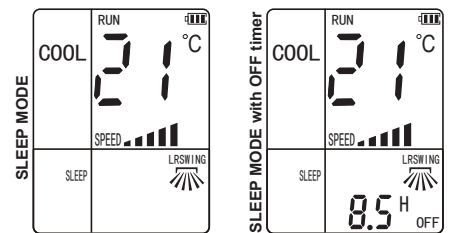

For Cooling: Allows the set temperature to increase and decrease over a 10 hour period at pre-set time intervals to maintain your comfort while saving energy (see graph right).

For Heating: Allows the set temperature to decrease and increase over a 10 hour period at pre-set time intervals to maintain your comfort while saving energy (see graph right).

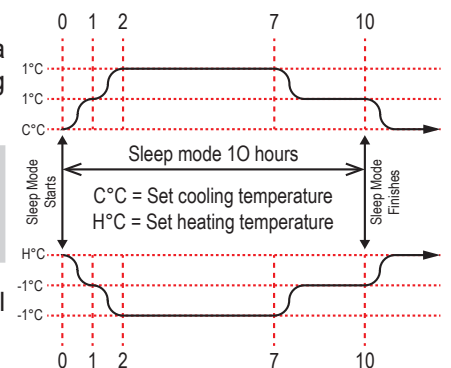

NOTE Sleep mode is not available in FAN only mode. The Delay Off Timer (see page 11) can be used in conjunction with SLEEP mode to turn off the air conditioner automatically.

4. Pressing the "SLEEP" button again will cancel sleep mode, "SLEEP" will no longer be shown on the LCD screen.



DELAY ON TIMER

1. With the appliance "OFF", press the "TIMER" button once, up to three digits and a blinking "ON" are shown at the bottom of the LCD screen.
2. Press \wedge or \vee to set the desired time period (the available time range is in 1/2 hour increments from 24 to 0.5 hours).
3. Press the "TIMER" button again to lock in the setting, both "TIMER" and a "ON" are shown on the LCD screen. The timer will count down the time remaining in half hour in increments. When the countdown is complete the appliance will turn on.

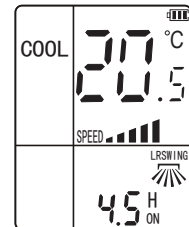
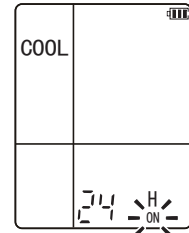

When setting a timer function, at each step failure to press buttons within 10 seconds will terminated the timer setup. If this happens you will need to re-start the timer setup procedure at step 1.

4. Set the mode, temperature and fan setting you wish the appliance to operate with when the "ON" time period is reached.

DELAY OFF TIMER

1. With the appliance "ON", press the "TIMER" button once, both "TIMER" and a blinking "OFF" are shown on the LCD screen.
2. Press \wedge or \vee to set the desired time period (the available time range is in 1/2 hour increments from 24 to 0.5 hours).
3. Press the "TIMER" button again to lock in the setting, both "TIMER" and a "ON" are shown on the LCD screen. The timer will count down the time remaining in half hour in increments. When the countdown is complete the appliance will turn off.

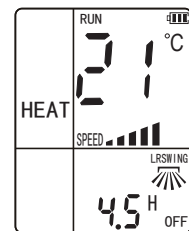
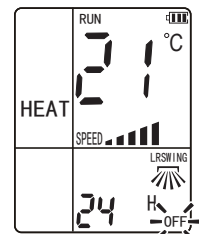

When setting a timer function, at each step failure to press buttons within 10 seconds will terminated the timer setup. If this happens you will need to re-start the timer setup procedure at step 1.

4. Set the mode, temperature and fan setting you wish the appliance to operate with until the "OFF" time period is reached.

CANCELLING ON/OFF TIMERS

1. When a timer is set, pressing the "TIMER" button will cancel any timer settings and the timer "OFF" or "ON" indicator will no longer be shown on the LCD screen.

ROOM TEMPERATURE DISPLAY

The remote control is capable of displaying either the set temperature or the current ambient room temperature.

1. To display the current room temperature, press the "ROOM °C" button once. "ROOM" is shown on the LCD screen and the temperature digits display the current room temperature.
2. To display the current set temperature, press the "ROOM °C" button again. "SET" is shown on the LCD screen and the temperature digits display the current set temperature.

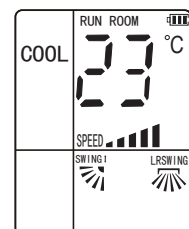

The "SET" temperature display is the default display for the remote control and will be reset when the controller is turned off and on.

When the room temperature mode is selected any changes to the set temperature will flash on the display for 5 seconds, after which the display will revert to displaying the current room temperature.



LARGE TEMPERATURE DISPLAY

The set and current room temperatures can be displayed via a large digital display that is built into appliance and illuminates through the front cover of the indoor unit.

To turn the display on

1. Press the "ON/OFF" button to turn on appliance.
2. Press the "DISPLAY" button, to activate the large digital temperature display.
3. Press the "DISPLAY" button again, to deactivate the large digital temperature display.



The large temperature display will display the same temperature setting as that currently in use by remote control.

NOTE When the room temperature mode is selected any changes to the set temperature will flash on the display for 5 seconds, after which the display will revert to displaying the current room temperature.

AUTO FRESH

Cooling and dehumidifying operations, can generate moisture inside the appliance. Using the "FRESH" function removes such moisture by allowing the fan to run for 3 minutes after every shut-down, avoiding odours and keeping the unit fresh.

1. With the appliance "OFF" press the "FRESH" button, "Anti-F" is shown on the LCD screen.
2. Pressing the "FRESH" button again will cancel the mode, "FRESH" will no longer be shown on the LCD screen.

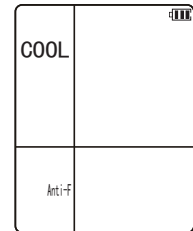

NOTE This function will not operate in **TIMER OFF** or **SLEEP** modes.

SPOT SWING

1. Press the "SWING↔" button.
2. There are 5 pre-set fixed air flow directions available, pressing the "SPOT SWING" button will allow you to cycle through each of these fixed directions.
3. To select a different fixed direction or to return to continuous circulation press the "SPOT SWING" button until the desired fixed direction is achieved or until the swing icon is again displayed.

CAUTION DO NOT attempt to adjust the air deflector louvre manually as this can result in damage to the louvre movement mechanisms.

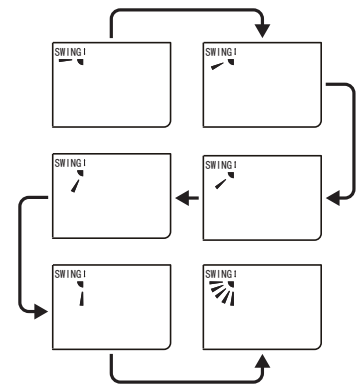

ECONOMY (COOLING ONLY)

In this mode the appliance automatically sets the operation to achieve the most economical cooling of the room.

1. Press the "ON/OFF" button to turn on appliance and select a cooling mode.
2. Press the "ECO" button, the appliance will run in ECO mode.
3. Pressing the "ECO" button again will cancel the mode, "ECO" will no longer be shown on the LCD screen.

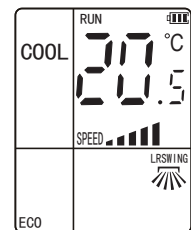

NOTE ECO mode operation runs for an 8 hour period, after which normal cooling operations will be resumed, to restart ECO mode after this period repeat step 2 above.

Be aware that ECO mode cooling times may be longer than those for non ECO mode cooling.



CLEANING OPERATION

Cooling and dehumidifying operations, can generate moisture inside the appliance. If the appliance is not going to be used for a long period (in excess of one month), it is suggested to run the cleaning operation to remove dust and moisture and avoid the odours.

1. With the appliance "OFF" press the "CLEAN" button, "iClean" is shown on the LCD screen.
2. Pressing the "CLEAN" button again will cancel the mode, "iClean" will no longer be shown on the LCD screen.

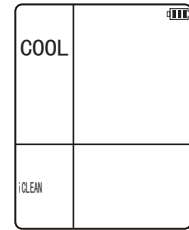

This cleaning operation takes approximately 35mins and the appliance automatically shuts off at completion of the cleaning cycle.

OPERATING THE AIR CONDITIONER WITHOUT THE REMOTE CONTROL

You can use the Manual ON/OFF (Auto) button of the indoor unit to operate the air conditioner when the remote control is unavailable.



When operated in this manner the appliance is set to AUTO OPERATION mode (as described in "Auto Operation" on page 11), cooling, heating and fan speed are all adjusted automatically by the appliance.

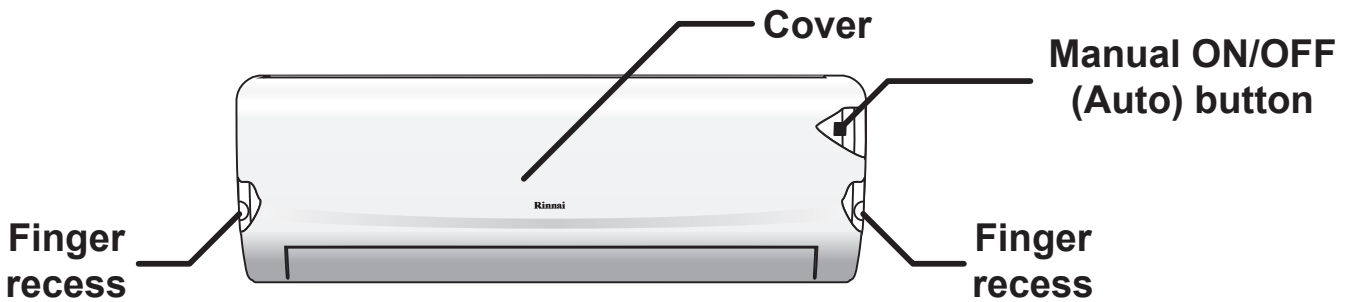

1. Open the front cover by locating the finger recesses located at each side and then lightly pull up both sides of the cover simultaneously to unlatch. Continue to rotate the cover upwards until it locks into the open position.
2. Press the Manual ON/OFF (Auto) button (located on the right side of the appliance).
3. Return the cover to the closed position.
4. To turn off, repeat steps 1 through 3.

POWER INTERRUPTION AUTOMATIC RESTART

Should a power outage occur while the appliance is operating,

When the power is restored the system will restart automatically using the same settings as those that were set before the power outage.



After power restoration, the automatic restart cycle will take approximately 5 minutes. DO NOT adjust setting during the restart cycle period.



CARE & MAINTENANCE

GENERAL MAINTENANCE

COMPONENT	DESCRIPTION	INTERVAL
Indoor unit	Clean the Indoor unit outer surface by using a soft, dry cloth.	Regularly
	Replace the remote control batteries.	As needed or once per year
	Professional service	Once per year
Outdoor unit	Professional service	Once per year



Turn off the power before you perform any maintenance; otherwise it may cause electric shock.

NEVER use water that is hotter than 40°C when you clean the filters. It may cause deformation or discolouration.

NEVER use volatile substances when you clean the filters. They may damage the surface of the product.



Make sure have your appliance professionally serviced once per year, failing to do so may decrease the operational efficiency or increase energy consumed.

CLEANING THE AIR FILTER

Clean the air filter once every 2 weeks or more if necessary.

1. Turn off the power
2. Open the front cover.
3. Hold the tab of the air filter, lift it up slightly and remove it from the unit.
4. Clean the filter with a vacuum cleaner or with warm water. If dirt is difficult to remove, wash the filter in lukewarm water with mild detergent.
5. Dry the filter in the shade.
6. Ensure to re-insert the filter securely after cleaning, observing the same orientation as when removed.



Failure to clean the filters regularly can cause condensation to form and drip from the indoor unit when operated in cooling mode during humid conditions.

If you need more filters, please contact Rinnai.

SAVE A SERVICE CALL

SYMPTOM	CAUSE
Water flowing noise.	This is the sound of refrigerant flowing inside the indoor unit and is normal.
Mist emanating form the indoor unit.	Condensation effect that can occur during cooling operations and is normal.
No display on remote control.	Possible flat batteries, replace the batteries with two fresh 1.5V (AAA) batteries, if after changing batteries the remote control still does not work contact Rinnai.
Remote control doe not operate the indoor unit.	Check for interference or obstructions that may be blocking the remote control signals, if interference or obstructions are not responsible then contact Rinnai.
The air conditioner stops running.	Check power supply or contact Rinnai.
	If a power failure has occurred. Turn off the air conditioner when a power failure occurs. When the power is restored, wait 3 minutes, and then turn on the air conditioner.
	Check the air conditioner has not been turned off automatically by a programmed off timer. Press the power button on the remote control.
The air conditioner does not generate cool / hot air.	Air is not circulating properly. Make sure that there are no curtains, blinds or furniture blocking the front of the air conditioner.
	The air filter is dirty. Clean the air filter once every 2 weeks. See "Cleaning Air Filter" for more information.
	The room temperature is too high. In summer, it may take some time to cool indoor air. In this case, select the turbo cool operation to cool indoor air quickly.
	The desired temperature is higher than the set temperature. Set the desired temperature to a level lower than the current temperature.
	There is a heating source nearby. Avoid using a heat generator such as an electric oven or a gas burner while the air conditioner is in operation
	The FAN ONLY mode of operation is selected. In this mode, air blows from the air conditioner without cooling or heating the indoor air. Switch the operation mode to the cooling, heating or auto.
It is not possible to adjust the fan speed.	In some operation modes, such as the turbo or dehumidifying operation modes, you cannot adjust the fan speed. Select an operation mode in which you can adjust the fan speed.
It is not possible to adjust the temperature.	In some operation modes, such as the auto, fan only or dehumidifying modes, you can not adjust the temperature. Select an operation mode in which you can adjust the temperature.

WHEN TO CALL FOR SERVICE

SYMPTOM	CAUSE
<p>There is a burning smell and a strange sound coming from the unit.</p> <p>Water leaks from the indoor unit even when the humidity level is low.</p> <p>When operated if a circuit breaker (safety, ground) is thrown or a fuse is blown.</p>	Turn off the air conditioner, and contact Rinnai.



WARRANTY

Rinnai Air Conditioning Product Warranty

NOTICE TO CONSUMERS UNDER AUSTRALIAN CONSUMER LAW

Notice to consumers under the Australian Consumer Law:

Our goods come with guarantees that cannot be excluded under the Australian Consumer Law. You are entitled to a replacement or refund for a major failure and compensation for any other reasonably foreseeable loss or damage. You are also entitled to have the goods repaired or replaced if the goods fail to be of acceptable quality and the failure does not amount to a major failure.

The benefits provided by this Warranty are in addition to any other rights and remedies of a consumer under the Australian Consumer Law and any other law which may apply to the Product.

Rinnai Australia Pty Ltd

1. WHAT IS COVERED BY THIS WARRANTY?

We warrant that your Rinnai Product purchased in Australia is free from defects in material and workmanship, subject to the terms and conditions contained in this document.

2. WARRANTY PERIOD

This Warranty applies to any defect in your Rinnai Product which appears within the period:

- (a) commencing on the installation date specified in the Compliance Certificate or, if the installation date cannot be established to Rinnai's satisfaction, commencing on the date 2 months after manufacture of the Product; and
- (b) determined in accordance with Schedule 1.

Any Product we repair or replace under this Warranty will only be warranted by us only for the balance of the original Warranty Period. You may have statutory rights outside of the Warranty Period.

3. WHAT WE WILL DO

To honour this Warranty, we will:

- (a) arrange for the Product to be repaired or replaced, at our option and expense, within a reasonable period; or
- (b) pay you an amount equivalent to the cost of repairing or replacing the Product.

If Rinnai provides you with either the replacement cost or replacement product, ownership of the original product shall immediately transfer to Rinnai.

Rinnai is responsible for reasonable costs associated with legitimate warranty claims, including call-out of an authorised Rinnai service provider to inspect the faulty product. Rinnai is not responsible for:

- (a) costs for tradespeople that are not authorised Rinnai service providers; or
- (b) any costs, including call-out costs for an authorised Rinnai service provider, associated with a product which is determined upon inspection not to be covered by this warranty.

The consumer will be reimbursed by Rinnai for any reasonable costs associated with making a legitimate warranty claim against Rinnai which are not otherwise specified above.

Enquiries relating to Warranty claims for Rinnai products or services must be made by contacting Rinnai Australia's National Sales and Service department. Contact details are on the back of this document.

4. WHAT WE NEED YOU TO DO

We need you to assist us with your claim by:

- (a) providing us with sufficient information to clearly identify the Product such as a Certificate of Compliance, proof of purchase or other substantially similar document;
- (b) providing us with a document which establishes that the Product was installed in accordance with the Manual and all applicable Regulations (we recommend that you provide us with a clear and legible Compliance Certificate for the Product);
- (c) reading clause 6 of this Warranty to ensure that none of the Exclusions in this section apply.

5. WARRANTY CONDITIONS

- (a) This warranty applies to products which are manufactured on or after the date of publication of this warranty but before the next date of publication of this warranty. Please contact Rinnai's Technical and Spare Parts department for further information about the warranty booklet publication dates.
- (b) All terms of this warranty are effective from date of completion of installation. The attending service person reserves the right to verify this date by requesting a proof of purchase or a copy of the certificate of compliance prior to the commencement of any warranty work. Where the date of completion of installation is not known, this warranty will commence two months after the date of manufacture. The date of manufacture is on the dataplate of the appliance.

Note: Certificates of compliance must be issued by the installer by law in all States and Territories of Australia.

- (c) All Rinnai heating and cooling appliances must be installed, commissioned, serviced, repaired and removed in accordance with the manufacturers installation instructions, current AS 3000, AS 3500 and AS 5601, local regulations and municipal building codes by persons authorised by local regulations to do so.
- (d) All appliances must be installed, operated and maintained in accordance with Installation / Operation Manual, and other technical or sales literature ("Manufacturer's Instructions").
- (e) Any inspection, service, repair or replacement activities associated with warranty on Rinnai products must be authorised by Rinnai Australia before commencement.
- (f) The warranty applies only to the components supplied by Rinnai. It does not apply to components supplied by others, such as, isolating valves, electrical switches, pipe work, electrical cables, fuses and where applicable, flue systems supplied by others, but not limited to these.
- (g) Where the appliance has not been sited in accordance with the installation instructions or installed such that normal service access is difficult, a service charge will apply. If at the discretion of the attending service person, access is deemed dangerous service will be refused. Any work required to gain reasonable access to the appliance will be chargeable by the attending service person (for example, removal of cupboards, doors, walls, trees, shrubs or the use of special equipment to move components to floor level, but not limited to these).
- (h) Where a product or a failed component is replaced under warranty, the time remaining on the original Product warranty period will continue to apply and the replacement product or part will be subject to the original product warranty period.
- (i) Rinnai reserve the right to transfer functional components from defective appliances if they are suitable.
- (j) Rinnai reserve the right to have the installed Product returned to the factory for inspection.

6. EXCLUSIONS

No warranties except those implied and that by law cannot be excluded are given by Rinnai in respect of Goods supplied. Where it is lawful to do so, the liability of Rinnai for a breach of a condition or warranty is limited to the repair or replacement of the Goods, the supply of equivalent Goods, the payment of the cost of repairing or replacing the Goods or acquiring equivalent Goods as determined by Rinnai.

This Warranty does not apply if the Product is outside Australia or if the claim is wholly or partly attributable to any:

- (a) defect in installation of the Product or any failure to install, use, service, maintain and repair the Product, in accordance with the Manual and all applicable Regulations;
- (b) misuse of the Product including use of the Product for purposes other than its intended purpose, use of the Product contrary to the Manufacturer’s Instructions, and use of the Product after it becomes apparent that it requires service, maintenance or repair;
- (c) accidental damage from external sources including fire, theft and explosion;
- (d) acts of God and damage or corrosion to the Product caused by environmental conditions including excessive moisture, acid rain, airborne fallout, stones, salt, sand, hail, wind, storms, lightning, floods, infestation by rodents or other vermin;
- (e) modification of the Product in a manner not authorised by Rinnai;
- (f) incorporation of parts other than Rinnai parts or other parts authorised by Rinnai;
- (g) normal wear and deterioration, having regard to the operating environment of the Product, including discolouration;
- (h) failure to respond in a timely manner to any malfunction of the Product;
- (i) failure due to abuse or misuse, improper maintenance, failure to maintain or improper storage.
- (j) failure or damage caused by alterations, service or repair work carried out by persons other than Rinnai service persons or service agents.
- (k) where it is found that there is no fault with the Product and the issue is related to the installation or is due to the failure of electric or gas supplies.
- (l) faults or substandard performance resulting from operation outside the manufacturer’s instructions will not be covered under this warranty.
- (m) parts not supplied by Rinnai. ie. power supply faults - power isolation, refrigeration piping - drain lines etc.

7. DEFINITIONS

“**Domestic Use**” means use of the Product for the climatic comfort of humans in:

- (a) ordinary domestic residential premises, such as houses or apartments; and
- (b) individual motel units, hotel rooms, caravans, mobile homes, and rooms in nursing homes, retirement village complexes, schools and other care institutions and like accommodation.

“**Commercial Use**” means any use of the Product for the climatic comfort of humans that is not Domestic Use.

“**Product**” means the air conditioning system manufactured by us and supplied with this Warranty in Australia, and used exclusively in Australia.

Schedule 1 – Warranty Period

Rinnai Air Conditioning Products	Parts and Labour
Domestic Use	5 years
Commercial Use	1 year



INSTALLATION RECORD

INSTALLER DETAILS

Installers Name: _____

Company Name: _____

Company Address: _____

Company Contact Details

Telephone: _____

Mobile Phone: _____

Certificate of Compliance / Certification Number: _____

Authorised Persons - Licence Number: _____

Installers Signature: _____

Installation Date: _____

SYSTEM DETAILS

Model Number : _____

Serial Number: _____

Installation Address: _____



Rinnai

Rinnai Australia Pty. Ltd. ABN 74 005 138 769

Head Office

100 Atlantic Drive,
Keysborough VIC 3173

P.O. Box 460
Braeside, Victoria 3195

Rinnai has a Service and Spare Parts network with personnel who are fully trained and equipped to give the best service on your Rinnai appliance. If your appliance requires service, please call our National Help Line. Rinnai recommends that this appliance be serviced every 1 years.

Product Sales and Service - National
Phone: 1300 555 545* Fax: 1300 555 655*
Technical Helpline and Spare Parts
National (Mon-Fri 8am - 5.30pm EST)
Phone: 1300 555 545* Fax: 1300 300 141*
**Cost of a local call higher from mobile or public phones.*

E-mail: enquiry@rinnai.com.au

For further information visit: www.rinnai.com.au

