



Built-In Electric Wall Oven

Safety Instructions 2-4

Operating Instructions

Clock and Timer 8
Convection 15
Oven Controls 5-19
Sabbath Feature 12
Steam Clean 21
Special Features 10, 11
Thermostat 20
Timed Baking and Roasting 9
Timed Convection 18-19
Using the Probe 14

Care and Cleaning

Control Panel 24
Glass Surfaces 24
Heating Element 24
Lift-Off Oven Door 22
Light 25
Oven Interior 25
Painted Surfaces 24
Racks 23
Stainless Steel Surfaces 24

Installation Instructions 26-30

Troubleshooting Tips 31-33

Consumer Support

Accessories 34
Consumer Support Back Cover
Warranty 35

Write the model and serial numbers here:

Model # _____

Serial # _____

You can find them on a label on the front of the oven behind the oven door.

*Owner's Manual
and Installation Instructions*

**SEW24115
LWOE241
EWOS241**

Felix Storch, Inc.
An ISO 9001:2015 registered company
770 Garrison Ave
Bronx, New York 10474
www.summitappliance.com



IMPORTANT SAFETY INFORMATION.

READ ALL INSTRUCTIONS BEFORE USING.

⚠ WARNING!

For your safety, the information in this manual must be followed to minimize the risk of fire or explosion, electric shock, or to prevent property damage, personal injury, or loss of life.



SAFETY PRECAUTIONS

When using electrical appliances, basic safety precautions should be followed, including the following:

- Use this appliance only for its intended purpose as described in this Owner's Manual.
- Be sure your appliance is properly installed and grounded by a qualified technician in accordance with the provided installation instructions.
- Do not attempt to repair or replace any part of your oven unless it is specifically recommended in this manual. All other servicing should be referred to a qualified technician.
- Have the installer show you the location of the circuit breaker or fuse. Mark it for easy reference.
- Before performing any service, disconnect the oven power supply at the household distribution panel by removing the fuse or switching off the circuit breaker.
- Do not leave children alone-children should not be left alone or unattended in an area where an appliance is in use. They should never be allowed to sit or stand on any part of the appliance.
- Do not allow anyone to climb, stand or hang on the door. They could damage the oven, or cause severe personal injury.
- Be sure the oven is securely installed in a cabinet that is firmly attached to the house structure. Never allow anyone to climb, sit, stand or hang on the oven door.
- Never leave the oven door open when you are not watching the oven.
- Always keep combustible wall covering, curtains or drapes a safe distance from your oven.
- Always keep dish towels, dish cloths, pot holders and other linens a safe distance from your oven.
- Always keep wooden and plastic utensils and canned food a safe distance away from your oven.
- Teach children not to play with the controls or any other part of the oven.
- Large scratches or impacts to glass doors can lead to broken or shattered glass.



⚠ **WARNING!** SAFETY PRECAUTIONS

- Do not store flammable materials in an oven.
 - **⚠ CAUTION:** Items of interest to children should not be stored in cabinets above an oven; children climbing on the oven to reach items could be seriously injured.
 - Never wear loose-fitting or hanging garments while using the appliance. Be careful when reaching for items stored in cabinets over the oven. Flammable material could be ignited if brought in contact with hot surfaces or heating elements and may cause severe burns.
 - Use only dry pot holders-moist or damp pot holders on hot surfaces may result in burns from steam. Do not let pot holders touch hot heating elements. Do not use a towel or other bulky cloth.
 - For your safety, never use your appliance for warming or heating the room.
 - Do not let cooking grease or other flammable materials accumulate in or near the oven.
 - Do not use water on grease fires. Never pick up a flaming pan. Turn the controls off.
 - Flame in the oven can be smothered completely by closing the oven door and turning the oven off by using a multi-purpose dry chemical or foam-type fire extinguisher.
 - Never leave jars or cans of fat drippings in or near your oven.
 - Do not store or use combustible materials, gasoline or other flammable vapors and liquids in the vicinity of this or any other appliance.
 - Stand away from the oven when opening the oven door. Hot air or steam which escapes can cause burns to hands, face and/or eyes.
 - Do not heat unopened food containers. Pressure could build up and the container could burst, causing an injury.
 - Keep the oven vent unobstructed.
 - Keep the oven free from grease buildup.
 - Place the oven rack in the desired position while the oven is cool. If racks must be handled when hot, do not let pot holder contact the heating elements.
 - When using cooking or roasting bags in the oven, follow the manufacturer's directions.
 - Do not touch the heating elements or the interior surface of the oven. These surfaces may be hot enough to burn even though they are dark in color. During and after use, do not touch, or let clothing or other flammable materials contact any interior area of the oven; allow sufficient time for cooling first.
 - Potentially hot surfaces include oven vent openings, surfaces near the openings, crevices around the oven door, the edges of the window and metal trim parts above the door.
- REMEMBER:** The inside surface of the oven may be hot when the door is opened.

IMPORTANT SAFETY INFORMATION. READ ALL INSTRUCTIONS BEFORE USING.



⚠ **WARNING!** SAFETY PRECAUTIONS

- Pulling out the rack to the stop-lock is a convenience in lifting heavy foods. It is also a precaution against burns from touching hot surfaces of the door or oven walls.
- Do not use the oven to dry newspapers. If overheated, they can catch on fire.
- Do not use the oven for a storage area. Items stored in an oven can ignite.
- Do not leave paper products, cooking utensils or food in the oven when not in use.
- After broiling, always take any broiler pan out of the oven and clean it. Leftover grease in a broiler pan can catch fire next time you use the pan.
- Clean only parts listed in this Owner's Manual.
- Do not use aluminum foil to line oven bottoms. Improper installation of aluminum foil may result in a risk of electric shock or fire.



COOK MEAT AND POULTRY THOROUGHLY...

Cook meat and poultry thoroughly—meat to at least an INTERNAL temperature of 160°F and poultry to at least an INTERNAL temperature of 180 °F. Cooking to these temperatures usually protects against foodborne illness.



**READ AND FOLLOW THIS SAFETY INFORMATION CAREFULLY.
SAVE THESE INSTRUCTIONS**

Using the oven controls.

Throughout this manual, features and appearance may vary from your model.

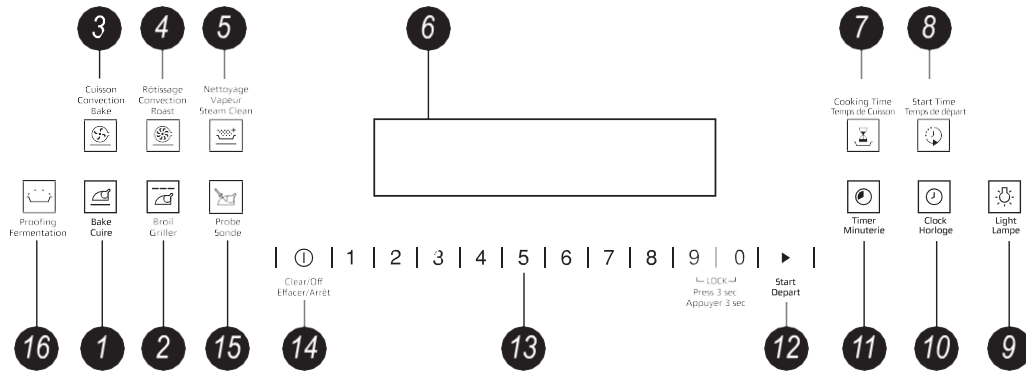

Oven Control, Clock and Timer Features and Settings

- 1 BAKE Pad**
Touch to select the bake function.
- 2 BROIL Pad**
Touch to select the broil function.
- 3 CONVECTION BAKE Pad**
Touch to select baking with the convection function.
- 4 CONVECTION ROAST Pad**
Touch to select roasting with the convection function.
- 5 STEAM CLEAN Pad**
Touch to select steam clean function. See the *Using the steam-clean oven section*.
- 6 Display**
Shows the time of day, oven temperature whether the oven is in the bake, broil or Steam Clean mode and the times set for the timer or automatic oven operations.

If "F-and a number or letter" flash in the display and the oven control signals, this indicates a function error code. Touch the OFF pad. Allow the oven to cool for one hour. Put the oven back into operation. If the function error code repeats, disconnect the power to the oven and call for service. If your oven was set for a timed oven operation and a power outage occurred, the clock and all programmed functions must be reset. The time of day will flash in the display when there has been a power outage.
- 7 COOKING TIME Pad**
Touch and then touch the number pads to set the amount of time you want your food to cook. The oven will shut off when the cooking time has run out.
- 8 START TIME Pad**
Use along with COOKING TIME pad to set the oven to start and stop automatically at a time you set.
- 9 LIGHT Pad**
Touch to turn the oven light on or off.
- 10 CLOCK Pad**
Touch before setting the clock.
- 11 TIMER Pad**
Touch to select the timer feature.
- 12 START Pad**
Must be touched to start any cooking or cleaning function.
- 13 Number Pads**
Use to set any function requiring numbers such as the time of day on the clock, the timer, the oven temperature, the internal food temperature, the delay start and length of operation for timed baking.
- 14 CLEAR/OFF Pad**
Touch to cancel ALL oven operations except the clock and timer.
- 15 PROBE Pad**
Touch to select sensor cooking temperature.
- 16 PROOFING Pad**
Touch to select a warm environment, useful for rising yeast-leavened products.

Temperature Conversions

Fahrenheit°	140	150	170	200	250	275	300	325	350	375	400	425	450	475	500	525	550
Celsius°	60	65	75	95	120	135	150	160	175	190	205	220	230	245	260	275	290

Using the oven controls.

To avoid possible burns, place the racks in the desired position before you turn the oven on.

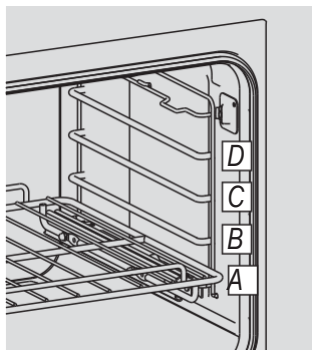

The oven has 4 rack positions.

Before you begin...

The racks have stop-locks, so that when placed correctly on the supports, they will stop before coming completely out, and will not tilt. When placing and removing cookware, pull the rack out to the bump on the rack support.

To remove a rack, pull it toward you, tilt the front end up and pull it out.

To replace, place the end of the rack (stoplocks) on the support, tilt up the front and push the rack in.

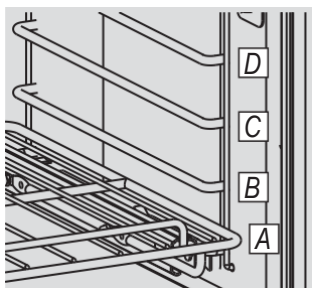

How to Set the Oven for Baking or Roasting

- 1 Touch the BAKE pad.
- 2 Touch the number pads to set the desired temperature.
- 3 Touch the START pad.
- 4 Check food for doneness at minimum time on recipe. Cook longer if necessary.
- 5 Touch the OFF pad when cooking is complete.

Type of Food	Rack Position
Frozen pies (on cookie sheet)	D
Angel food cake	A
Bundt or pound cakes	B or C
Biscuits, muffins, brownies, cookies, cupcakes, layer cakes, pies	C or D
Casseroles	C or D
Turkey	A

NOTE: A cooling fan may automatically turn on and off to cool internal parts. This is normal, and the fan may continue to run even after the oven is turned off.

Preheating and Pan Placement

Preheat the oven if the recipe calls for it. To preheat, set the oven at the correct temperature. Preheating is necessary for good results when baking cakes, cookies, pastry and breads.

Baking results will be better if baking pans are centered in the oven as much as possible. Pans should not touch each other or the walls of the oven. If you need to use two racks, stagger the pans so one is not directly above the other, and leave approximately 1½" between pans, from the front, back and sides of the wall.

Aluminum Foil

⚠ WARNING!

Do not use aluminum foil on the bottom of the oven.

Never entirely cover a rack with aluminum foil. This will disturb the heat circulation and result in poor baking.

A smaller sheet of foil may be used to catch a spillover by placing it on a lower rack several inches below the food.

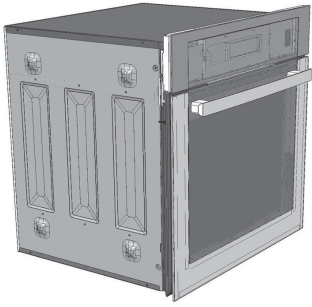

Leave the door closed in broil function to better cooking results.

How to Set the Oven for Broiling

- 1 Place the meat or fish on a broiler grid in a broiler pan designed for broiling.
- 2 Close the oven door.
- 3 Touch the BROIL pad once for HI Broil. To change to LO Broil, touch the BROIL pad again.
- 4 Touch the **START** pad.
- 5 When broiling is finished, touch the **CLEAR/OFF** pad.

Using the clock and timer.



Clock
Horloge

Make sure the clock is set to the correct time of day.

To Set the Clock

The clock must be set to the correct time of day for the automatic oven timing functions to work properly. The time of day cannot be changed during a timed baking or cleaning cycle.

- 1 Touch the CLOCK pad.
- 2 Touch the number pads.
- 3 Touch the START pad.



Timer
Minuterie

The Timer is a minute timer only. The Timer does not control oven operations. The maximum setting on the Timer is 9 hours and 59 minutes.

To Set the Timer

- 1 Touch the TIMER pad.
- 2 Touch the number pads until the amount of time you want shows in the display. For example, to set 2 hours and 45 minutes, touch 2, 4 and 5 in that order. If you make a mistake, touch the TIMER pad and begin again.
- 3 Touch the START pad.

After touching the START pad, SET disappears; this tells you the time is counting down, although the display does not change until one minute has passed. Seconds will not be shown in the display until the last minute is counting down.

- 4 When the Timer reaches :00, the control will beep 3 times followed by one beep every 6 seconds until the TIMER pad is touched.

The 6-second tone can be canceled by following the steps in the Special features of your oven control section under Tones at the End of a Timed Cycle.

To Cancel the Timer

Touch the TIMER pad twice.

Using the timed baking and roasting features.

NOTE: Foods that spoil easily, such as milk, eggs, fish, stuffing, poultry, and pork should not be allowed to sit for more than 1 hour before or after cooking. Room temperature promotes the growth of harmful bacteria. Be sure that the oven light is off because heat from the bulb will speed harmful bacteria growth.

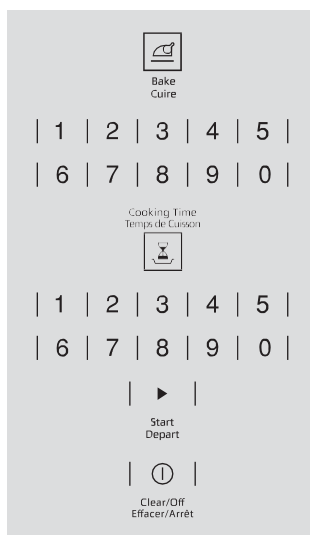

How to Set an Immediate Start and Automatic Stop

The oven will turn on immediately and cook for a selected length of time. At the end of the cooking time the oven will turn off automatically.

- 1 Touch the **BAKE** pad.
- 2 Touch the number pads to set the desired oven temperature.
- 3 Touch the **COOKING TIME** pad.

NOTE: If your recipe requires preheating, you may need to add additional time to the length of the cooking time.

- 4 Touch the number pads to set the desired length of cooking time. The minimum cooking time you can set is 1 minute.

The oven temperature that you set and the cooking time that you entered will be in the display.

- 5 Touch the **START** pad.

NOTE: An attention tone will sound if you are using timed baking and do not touch the **START** pad.

The oven will turn ON, and the display will show the cooking time countdown and the changing temperature starting at 37.8 °C (100 °F). (The temperature display will start to change once the oven temperature reaches 37.8 °C [100 °F]).

When the oven reaches the temperature you set, 3 beeps will sound. The oven will continue to cook for the set amount of time, then turn off automatically.

- 6 Touch the **OFF** pad to clear the display if necessary. Remove the food from the oven. Remember, even though the oven turns off automatically, food left in the oven will continue cooking after the oven turns off.

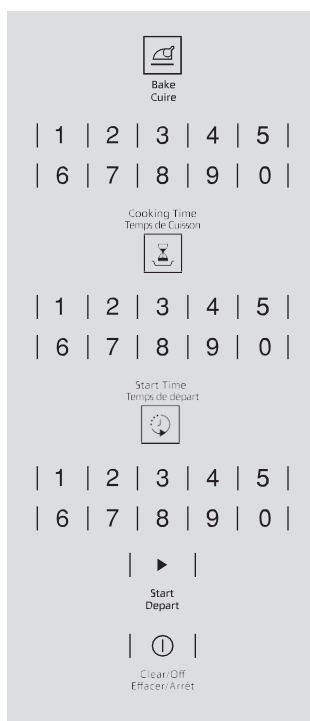

How to Set a Delayed Start and Automatic Stop

The oven will turn on at the time of day you set, cook for a specific length of time and then turn off automatically.

Make sure the clock shows the correct time of day.

- 1 Touch the **BAKE** pad.
- 2 Touch the number pads to set the desired oven temperature.
- 3 Touch the **COOKING TIME** pad.

NOTE: If your recipe requires preheating, you may need to add additional time to the length of the cooking time.

- 4 Touch the number pads to set the desired length of cooking time. The minimum cooking time you can set is 1 minute.

The oven temperature that you set and the cooking time that you entered will be in the display.

- 5 Touch the **START TIME** pad.

NOTE: An attention tone will sound if you are using timed baking and do not touch the **START** pad.

When the oven turns ON at the time of day you set, the display will show the cooking time countdown and the changing temperature starting at 37.8 °C (100 °F). (The temperature display will start to change once the oven temperature reaches 37.8 °C [100 °F]). When the oven reaches the temperature you set, 3 beeps will sound. The oven will continue to cook for the set amount of time, then it turns off automatically.

- 6 Touch the **OFF** pad to clear the display if necessary. Remove the food from the oven. Remember, even though the oven turns off automatically, food left in the oven will continue cooking after the oven turns off.

Special features of your oven control.

Your new touch pad control has additional features that you may choose to use. The following are the features and how you may activate them.

The special feature modes can only be activated while the display is showing the time of day. They remain in the control's memory until the steps are repeated.

When the display shows your choice, touch the **START** pad. The special features will remain in memory after a power failure, except for the Sabbath feature, which will have to be reset.



12-Hour Shutdown

With this feature, should you forget and leave the oven on, the control will automatically turn off the oven after 12 hours during baking functions or after 3 hours during a broil function.

If you wish to turn OFF this feature, follow the steps below.

- 1 Touch the BROIL and BAKE pads at the same time for 3 seconds until the display shows SF.

- 2 Touch the START TIME pad until no shdn (no shut-off) appears in the display.
- 3 Touch the START pad to activate the no shut-off and leave the control set in this special features mode.

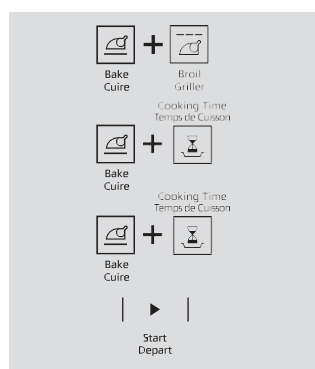

Fahrenheit or Celsius Temperature Selection

Your oven control is set to use the Fahrenheit temperature selections but you may change this to use the Celsius selections.

- 1 Touch the BROIL and BAKE pads at the same time for 3 seconds until the display shows SF.
- 2 Touch the BROIL and COOKING TIME pads. The display will show F (Fahrenheit).

- 3 Touch the BROIL and COOKING TIME pads again. The display will show C (Celsius).
- 4 Touch the START pad.

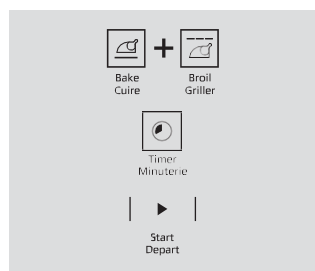

Tones at the End of a Timed Cycle

At the end of a timed cycle, 3 short beeps will sound followed by one beep every 6 seconds until the OFF pad is touched. This continual 6 second beep may be canceled.

To cancel the 6-second beep:

- 1 Touch the BROIL and BAKE pads at the same time for 3 seconds until the display shows SF.

- 2 Touch the TIMER pad. The display shows CON BEEP (continuous beep). Touch the TIMER pad again. The display shows BEEP. (This cancels the one beep every 6 seconds.)
- 3 Touch the START pad.



Control Lockout

Your control will allow you to lock out the touch pads so they cannot be activated when touched.

To activate this feature:

- 1 Touch the 9 and 0 pads at the same time for 3 seconds until the control beeps twice. The display will show **LOC** continuously and the time of day, if not blacked out.

NOTE: All cooking and timing functions will be cancelled when locking out the control.

- 2 To unlock the control, touch the 9 and 0 pads at the same time for 3 seconds until the control beeps twice and **LOC** is removed from the display.



12-Hour, 24-Hour or Clock Blackout

Your control is set to use a 12-hour clock.

If you would prefer to have a 24-hour military time clock or black out the clock display, follow the steps below.

- 1 Touch the BROIL and BAKE pads at the same time for 3 seconds until the display shows **SF**.
- 2 Touch the CLOCK pad once. The display will show **12 hr**. If this is the choice you want, touch the START pad.

- 3 Touch the CLOCK pad again to change to the 24 hour military time clock. The display will show **24 hr**. If this is the choice you want, touch the START pad.
- 4 Touch the CLOCK pad again to black out the clock display. The display will show **OFF**. If this is the choice you want, touch the START pad.

NOTE: If the clock is in the black-out mode you will not be able to use the Start Time function.



Auto Recipe™ Conversion

When using convection bake, the Auto Recipe™ Conversion feature will automatically convert entered regular baking temperatures to convection baking temperatures.

This feature is activated so that the display will show the actual converted (reduced) temperature. For example, if you enter a regular recipe temperature of 176.7 °C (350 °F) and touch the START pad, the display will show **CON** and the converted temperature of 162.8 °C (325 °F).

To deactivate the feature:

- 1 Touch the oven BAKE and BROIL pads at the same time until the display shows SF.
- 2 Touch the CONVECTION BAKE pad. The display will show CON ON. Touch the CONVECTION BAKE pad again. The display will show CON OFF.
- 3 Touch the START pad.

To reactivate the feature, repeat steps 1-3 above but touch the START pad when CON ON is in the display.



Using the Sabbath feature.

(Designed for use on the Jewish Sabbath and Holidays)

The Sabbath feature can be used for baking/roasting only. It cannot be used for convection, broiling or Delay Start cooking.

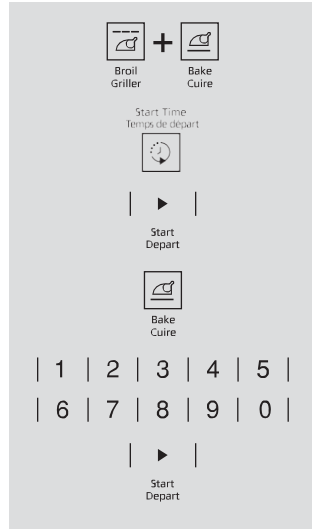
NOTE: The oven light comes on automatically when the door is opened and goes off when the door is closed. The bulb may be removed. See the Oven Light Replacement section. On models with a light switch on the control panel, the oven light may be turned on and left on.



When the display shows  the oven is set in Sabbath. When the display shows  the oven is baking/roasting.

How to Set for Regular Baking/Roasting



Make sure the clock shows the correct time of day and the oven is off.

- 1 Touch and hold both the BROIL and BAKE pads, at the same time, until the display shows SF.

NOTE: If bake or broil appears in the display, the BROIL and BAKE pads were not touched at the same time. Touch the OFF pad and begin again.

- 2 Touch the START TIME pad until SA b bAtH appears in the display.
- 3 Touch the START pad and  will appear in the display.
- 4 Touch the BAKE pad. No signal will be given.
- 5 Using the number pads, enter the desired temperature between 77 °C (170 °F) and 288 °C (550 °F). No signal or temperature will be given.

- 6 Touch the START pad.

- 7 After a random delay period of approximately 30 seconds to 1 minute,  will appear in the display indicating that the oven is baking/roasting. If  doesn't appear in the display, start again at Step 4.

To adjust the oven temperature, touch the BAKE pad, enter the new temperature using the number pads and touch the START pad. NOTE: The OFF and COOKING TIME pads are active during the Sabbath feature.

How to Set for Timed Baking/Roasting-Immediate Start and Automatic Stop

Make sure the clock shows the correct time of day and the oven is off.

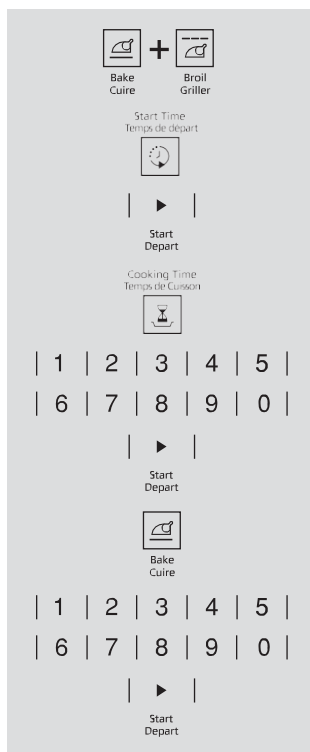

When the display shows ▷ the oven is set in Sabbath. When the display shows ▷C the oven is baking/roasting.

- 1 Touch and hold both the BROIL and BAKE pads at the same time, until the display shows **SF**.

NOTE: If bake or broil appears in the display, the BROIL and BAKE pads were not touched at the same time. Touch the OFF pad and begin again.
- 2 Tap the START TIME pad until **SabbAtH** appears in the display.
- 3 Touch the START pad and ▷ will appear in the display.
- 4 Touch the COOKING TIME pad.
- 5 Touch the number pads to set the desired length of cooking time between 1 minute and 9 hours and 99 minutes. The cooking time that you entered will be displayed.
- 6 Touch the START pad.
- 7 Touch the BAKE pad. No signal will be given.
- 8 Using the number pads, enter the desired temperature. No signal or temperature will be given.
- 9 Touch the START pad.
- 10 After a random delay period of approximately 30 seconds to 1 minute, ▷C will appear in the display indicating that the oven is baking/roasting. If ▷C doesn't appear in the display, start again at Step 7.

To adjust the oven temperature, touch the BAKE pad, enter the new temperature using the number pads and touch the START pad. When cooking is finished, the display will change from ▷C to ▷ and 0:00 will appear, indicating that the oven has turned OFF but is still set in Sabbath. Remove the cooked food.

How to exit the Sabbath feature

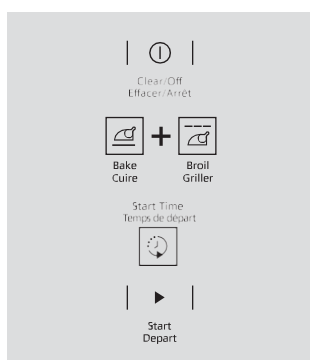

- 1 Touch the OFF pad.
- 2 If the oven is cooking, wait for a random delay period of approximately 30 seconds to 1 minute, until only ▷ is in the display.
- 3 Touch and hold both the BROIL and BAKE pads at the same time, until the display shows **SF**.
- 4 Tap the START TIME pad until **12shdn** or **no shdn** appears in the display.
- 5 Choose **12 shdn**, indicating that the oven will automatically turn after 12 hours or **no shdn**, indicating that the oven will not automatically turn after 12 hours.
- 6 Press START when the option that you want is in the display (**12 shdn** or **no shdn**).

NOTE: If a power outage occurred while the oven was in Sabbath, the oven will automatically turn off and stay off even when the power returns. The oven control must be reset.

Using the probe.



CAUTION

To prevent burns, do not unplug the probe from the oven outlet until the oven has cooled. Do not store the probe in the oven.

For many foods, especially roasts and poultry, internal food temperature is the best test for doneness. The temperature probe takes the guesswork out of cooking foods to the exact doneness you want.

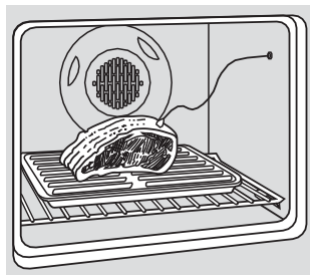

The temperature probe has a skewer-like probe at one end and a plug at the other end that goes into the outlet in the oven.

Use of probes other than the one provided with this product may result in damage to the probe.

Use the handles of the probe and plug when inserting and removing them from the food and outlet.

- To avoid damaging your probe, do not use tongs to pull on the cable when removing it.
- To avoid breaking the probe, make sure food is completely defrosted before inserting.

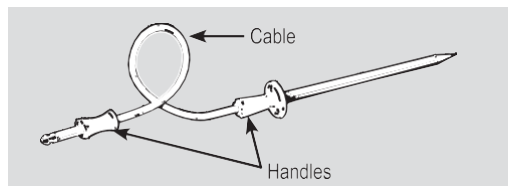

- To prevent possible burns, do not unplug the probe from the outlet until the oven has cooled.
- Do not store the probe in the oven.
- Never leave your probe inside the oven during broil cycle.

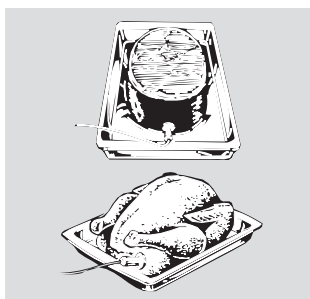

After preparing the meat and placing it on a trivet or on a broiler pan grid, follow these directions for proper probe placement.

Insert the probe completely into the meat. It should not touch the bone, fat or gristle.

For roasts with no bone, insert the probe into the meatiest part of the roast. For bone-in ham or lamb, insert the probe into the center of the lowest large muscle.

Insert the probe into the center of dishes such as meat loaf or casseroles.

Insert the probe into the meatiest part of the inner thigh from below and parallel to the leg of a whole turkey.

NOTE: Broil settings will not work if the temperature probe is plugged in.

How to Set the Oven For Cooking When Using the Probe

- 1 Insert the probe into the food.
- 2 Plug the probe into the outlet in the oven. Make sure it's pushed all the way in. Close the oven door.
- 3 Touch the **Probe** pad.
- 4 Touch the number pads to set the desired internal food or meat temperature between 100°F and 200°F.
- 5 Touch the **Bake** pad.
- 6 Touch the number pads to set the desired oven temperature.
- 7 Touch the **Start** pad.

The display will flash **LO** if the probe is inserted into the outlet and you have not set a probe temperature and touched the Start pad.

The display will show **LO** until the internal temperature of the food reaches 100°F; then the changing internal temperature will be shown.

- 7 When the internal temperature of the food reaches the number you have set, the probe and the oven turn off and the oven control signals. To stop the signal, touch the **Clear/Off** pad. Use hot pads to remove the probe from the food. Do not use tongs to pull on it—they might damage it.

To change the oven temperature during probe cooking, touch the **Bake** pad and then the number pads to set the new temperature.

- If the probe is removed from the food before the final temperature is reached, a tone will sound and the display will flash until the probe is removed from the oven.
- You can use the timer even though you cannot use timed oven operations while using the probe.

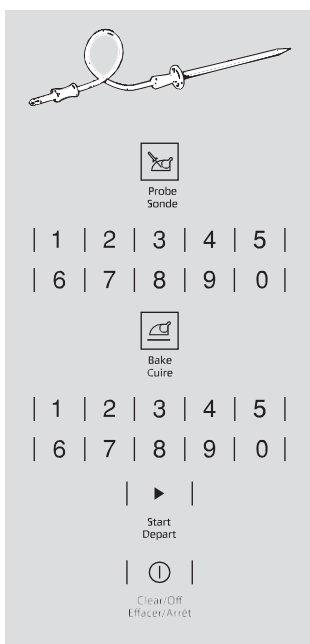

Using the convection oven.

The convection oven fan shuts off when the oven door is opened. DO NOT leave the door open for long periods of time while using convection cooking.

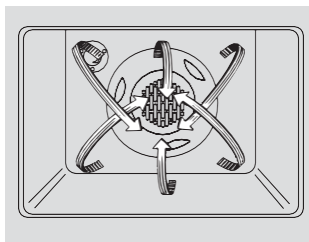

In a convection oven, a fan circulates hot air over, under and around the food. This circulating hot air is evenly distributed throughout the oven cavity. As a result, foods are evenly cooked and browned-often in less time than with regular heat.

To help you understand the difference between convection bake and roast and traditional bake and roast, here are some general guidelines.

Convection Bake

The convection fan circulates the heated air evenly over and around the food.

- Preheat the oven.
- Ideal for foods cooked on multiple racks.
- Good for large quantities of baked foods.
- Good results with cookies, biscuits, brownies, cupcakes, cream puffs, sweet rolls, angel food cake and bread.

Convection Roast

- Good for large tender cuts of meat, uncovered.

The convection fan circulates the heated air evenly over and around the food. Meat and poultry are browned on all sides, as if they were cooked on a rotisserie. Heated air will be circulated over, under and around the food being roasted. The heated air seals in juices quickly for a moist and tender product while, at the same time, creating a rich golden-brown exterior.

Roasts or poultry should be cooked on rack position (A).

When you are convection roasting, it is important that you use a broiler pan and grid for best convection roasting results. The pan is used to catch grease spills and the grid is used to prevent grease spatters.

- Place the rack in rack position (A).

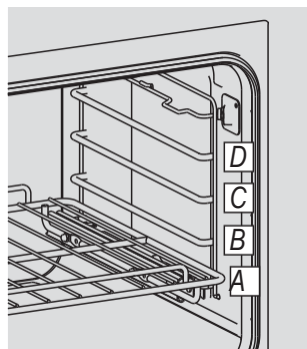

Using the convection oven.

Cookware for Convection Cooking

Before using your convection oven, check to see if your cookware leaves room for air circulation in the oven. If you are baking with several pans, leave space between them. Also, be sure the pans do not touch each other or the walls of the oven.

Paper and Plastic

Heat-resistant paper and plastic containers that are recommended for use in regular ovens can be used in convection ovens. Plastic cookware that is heat-resistant to temperatures of 400°F can also be used, when oven is below 400°F.

Metal and Glass

Any type of cookware will work in your convection oven. However, metal pans heat the fastest and are recommended for convection baking.

- Darkened or matte-finished pans will bake faster than shiny pans.
- Glass or ceramic pans cook more slowly.

When baking cookies, you will get the best results if you use a flat cookie sheet instead of a pan with low sides.

For recipes like oven-baked chicken, use a pan with low sides. Hot air cannot circulate well around food in a pan with high sides.

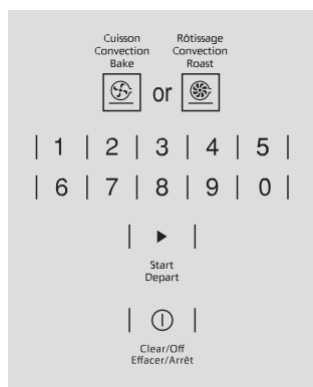

How to Set the Oven for Convection Baking or Roasting

- 1 Touch the CONVECTION BAKE or CONVECTION ROAST pad.
- 2 Touch the number pads to set the desired oven temperature.
- 3 Touch the Start pad.

To change the oven temperature, touch the CONVECTION BAKE or CONVECTION ROAST pad and then the number pads to set the new temperature.

When the oven starts to heat, the changing temperature, starting at 100°F, will be displayed. When the oven reaches the temperature you set, 3 beeps will sound.

- 4 Touch the CLEAR/OFF pad when finished.

NOTE: You will hear a fan while cooking with convection. The fan will stop when the door is opened, but the heat will not turn off.

The fan will not start until the preheat temperature is reached.

How to Set the Oven for Convection Roasting When Using the Probe

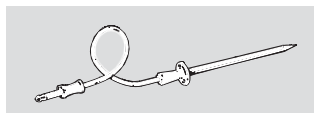

For best results when roasting large turkeys and roasts, we recommend using the probe included in the convection oven.

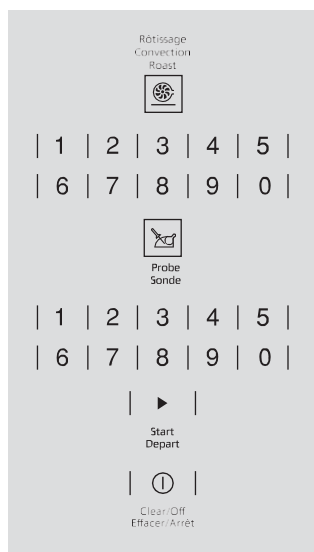

The display will flash **PROBE** and the oven control will signal if the probe is inserted into the outlet, and you have not set a probe temperature and touched the Start pad.

- 1 Place the rack in the rack position (A). Insert the probe completely into the food.
- 2 Plug the probe into the outlet in the oven. Make sure it is pushed all the way in. Close the oven door.
- 3 Touch the CONVECTION ROAST pad.
- 4 Touch the number pads to set the desired oven temperature.
- 5 Touch the **Probe** pad.
- 6 Touch the number pads to set the desired internal food temperature.

To change the oven temperature during the Convection Roast cycle, touch the CONVECTION ROAST pad and then touch the number pads to set the new desired temperature.

- 7 Touch the Start pad.

When the oven starts to heat, the word **LO** will be in the display.

After the internal temperature of the food reaches 100°F, the changing internal temperature will be shown in the display.

- 8 When the internal temperature of the food reaches the number you have set, the probe and the oven turn off and the oven control signals. To stop the signal, touch the CLEAR/OFF pad. Use hot pads to remove the probe from the food. Do not use tongs to pull on it—they might damage it.

CAUTION

To prevent burns, do not unplug the probe from the oven outlet until the oven has cooled. Do not store the probe in the oven.

NOTE:

- If the probe is removed from the food before the final temperature is reached, a tone will sound and the display will flash until the probe is removed from the oven.
- You will hear a fan while cooking with this feature. The fan will stop when the door is opened but the heat will not turn off.
- You can use the timer even though you cannot use timed oven operations while using the probe.
- Probe is not for use in Broil functions.

CAUTION

Do not use probe when cooking in rack level D.

Using the oven timed convection baking features.

You will hear a fan while cooking with this feature. The fan will stop when the door is opened but the heat will not turn off.

NOTE: Foods that spoil easily—such as milk, eggs, fish, stuffing, poultry and pork—should not be allowed to sit for more than 1 hour before or after cooking. Room temperature promotes the growth of harmful bacteria. Be sure that the oven light is off because heat from the bulb will speed harmful bacteria growth.

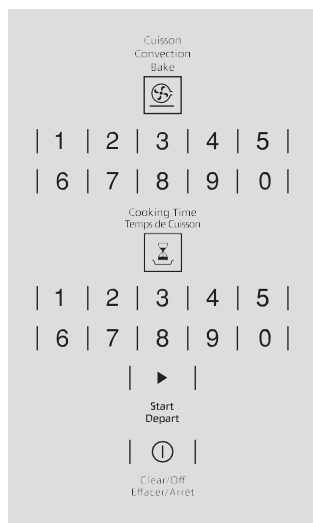

How to Set an Immediate Start and Automatic Stop

The oven will turn on immediately and cook for a selected length of time. At the end of the cooking time, the oven will turn off automatically.

- 1 Touch the CONVECTION BAKE pad.
- 2 Touch the number pads to set the desired oven temperature.
- 3 Touch the COOKING TIME pad.

NOTE: If your recipe requires preheating, you may need to add additional time to the length of the cooking time.

- 4 Touch the number pads to set the desired length of cooking time. The minimum cooking time you can set is 1 minute.

The oven temperature that you set and the cooking time that you entered will be in the display.

- 5 Touch the START pad.

The oven will turn ON, and the display will show the cooking time countdown and the changing temperature starting at 100°F. (The temperature display will start to change once the oven temperature reaches 100°F.) When the oven reaches the temperature you set, 3 beeps will sound.

The oven will continue to cook for the set amount of time, then turn off automatically, unless the Cook and Hold feature was set. See the Special features of your oven control section.

After the oven turns off, the end-of-cycle tone will sound.

- 6 Touch the CLEAR/OFF pad to clear the display if necessary. Remove the food from the oven. Remember, even though the oven turns off automatically, food left in the oven will continue cooking after the oven turns off.

Using the oven timed convection baking features.

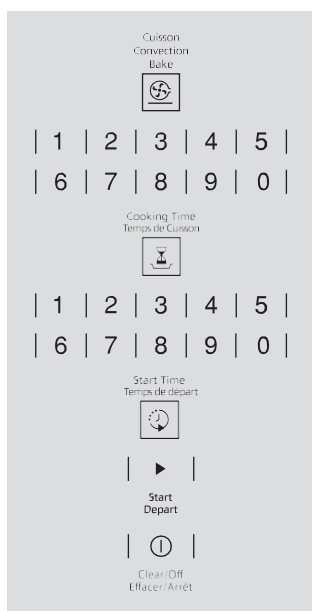

How to Set a Delayed Start and Automatic Stop

The oven will turn on at the time of day you set, cook for a specific length of time and then turn off automatically.

Make sure the clock shows the correct time of day.

- 1 Touch the CONVECTION BAKE pad.
- 2 Touch the number pads to set the desired oven temperature.
- 3 Touch the COOKING TIME pad.

NOTE: If your recipe requires preheating, you may need to add additional time to the length of the cooking time.

- 4 Touch the number pads to set the desired length of cooking time. The minimum cooking time you can set is 1 minute.

The oven temperature that you set and the cooking time that you entered will be in the display.

- 5 Touch the START TIME pad.
- 6 Touch the number pads to set the time of day you want the oven to turn on and start cooking.
- 7 Touch the START pad.

NOTE: If you would like to check the times you have set, touch the START TIME pad to check the start time you have set or touch the COOKING TIME pad to check the length of cooking time you have set.

When the oven turns **ON** at the time of day you set, the display will show the cooking time countdown and the changing temperature starting at 100°F. (The temperature display will start to change once the oven temperature reaches 100 °F. When the oven reaches the temperature you set, 3 beeps will sound.

The oven will continue to cook for the set amount of time, then turn off automatically, unless the **Cook and Hold** feature was set. See the Special features of your oven control section.

After the oven turns off, the end-of-cycle tone will sound.

- 8 Touch the CLEAR/OFF pad to clear the display if necessary. Remove the food from the oven. Remember, even though the oven turns off automatically, food left in the oven will continue cooking after the oven turns off.

Adjust the oven thermostat - Do it yourself

You may find that your new oven cooks differently than the one it replaced. Use your new oven for a few weeks to become more familiar with it. If you still think your new oven is too hot or too cold, you can adjust the thermostat yourself.

Do not use thermometers, such as those found in grocery stores, to check the temperature setting of your oven. These thermometers may vary 6-11 degrees Celsius (20-40 degrees Fahrenheit).

NOTE: This adjustment will only affect baking and roasting temperatures; it will not affect broiling temperatures. The adjustment will be retained in memory after a power failure.

To Adjust the Thermostat

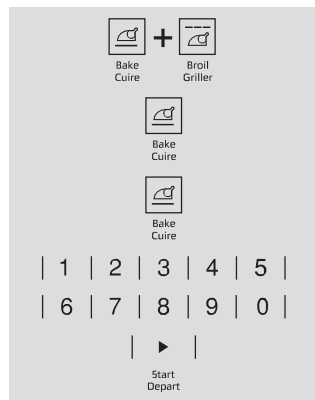

- 1 Touch the BAKE and BROIL pads at the same time for 3 seconds until the display shows **SF**.
- 2 Touch the BAKE pad.
Touch BAKE again to alternate between increasing and decreasing the oven temperature.
- 3 Press the number pads to set a user offset.
- 4 Press BAKE pad to switch between positive or negative offset values.
- 5 The oven temperature can be adjusted up to (+) 19 °C (35 °F) hotter or (-) 19 °C (35 °F) cooler. Touch the number pads the same way you read them. For example, to change the oven temperature 12 °C (15 °F), touch **1** and **5**.
- 6 When you have made the adjustment, touch the START pad to go back to the time of day display. Use your oven as you would normally.

The type of margarine will affect baking performance.

Most recipes for baking have been developed using high fat products such as butter or margarine (80% fat). If you decrease the fat, the recipe may not give the same results as with a higher fat product.

Recipe failure can result if cakes, pies, pastries, cookies or candies are made with low fat spreads. The lower the fat content of a spread product, the more noticeable these differences become.

Federal standards require products labeled "margarine" to contain at least 80% fat by weight. Low fat spreads, on the other hand, contain less fat and more water. The high moisture content of these spreads affects the texture and flavor of baked goods. For best results with your old favorite recipes, use margarine, butter or stick spreads containing at least 70% vegetable oil.

Using the proofing feature.

The proofing feature maintains a warm environment useful for rising yeast-leavened products.

How to Set the Oven For Proofing

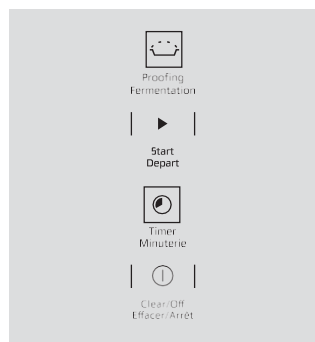

- 1 Place the covered dough in a dish in the oven on rack B or C.
- 2 Touch the PROOF pad and then the START pad.
The display will show **PrF** (proof).
The oven interior light turns on and remains on during proofing.
The proofing feature automatically provides the optimum temperature for the proofing process, and therefore does not have a temperature adjustment.
- 3 Set the TIMER for the minimum proof time.
- 4 When proofing is finished, touch the OFF pad.

- To avoid lowering the oven temperature and lengthening proofing time, do not open the oven door unnecessarily.
- Check bread products early to avoid over-proofing.

NOTE:

- Do not use the proofing mode for warming food or keeping food hot. The proofing oven temperature is not hot enough to hold foods at safe temperatures.
- Proofing will not operate when oven is above 65 °C (150 °F). "HOT" will show in the display.

NOTE:

Use as an optional feature the proofing mode to defrost food placed in a baking dish. Periodically monitor the unfreezing of food grade and remove from oven as soon as it has thawed. Defrost cycle is a slow process required for optimal results.

Using Steam Clean

CAUTION

During the steam clean cycle, the oven bottom becomes hot enough to cause burns. Wait until the cycle is over (30 minutes) before wiping the inside surfaces of the oven. Failure to do so may result in burns. The Steam Clean cycle makes it easier to clean light soiling off the porcelain oven interior.

The wall oven should be at room temperature before beginning the Steam Clean cycle. If the oven is too hot, "hot" will appear on the display and the cycle will not activate until the oven cools down.

The Steam Clean cycle performs best on new spills or soils. Burned-on food is more difficult to remove.



Pour 7 ounces of water onto the oven floor.

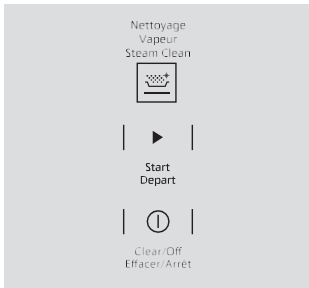

To Begin Steam Clean Cycle:

- 1 Remove racks and accessories from the oven cavity. Do not place cookware or other items in the oven during the Steam Clean cycle.
- 2 Pour 200 ml (7 oz.) room-temperature water onto the recessed area of the oven bottom. Do not add cleaning solutions or chemicals of any kind to the water.
- 3 Close the door.
- 4 Activate the Steam Clean function by pressing the STEAM CLEAN pad, then presstart.
- 5 A 30-minute cycle will begin to count down on the display.
- 6 When the Steam Clean cycle is complete, the oven control will beep. Press OFF pad and open the door.
- 7 The oven bottom and remaining water will still be warm at the end of the cycle. This is normal.
- 8 Remove soils using a scrub brush or nylon scouring pad. A soap-filled steel wool pad may be used only on the porcelain oven interior. The use of abrasive pads will scratch the door glass. Do not wipe soil or water onto the door gasket.
- 9 **Remove any remaining water with a dry cloth or sponge.**
- 10 Leave the door open to air dry.

IMPORTANT NOTES:

- If a steam clean cycle is initiated without water, press the off pad to end the cycle. Wait for the wall oven to cool to room temperature before pouring water into the recessed area and initiating another steam cycle.
- Press OFF pad at any time to end the cycle.
- If mineral deposits remain in the oven bottom after cleaning, use a cloth or sponge soaked in vinegar to remove them.
- Some water may drip from the bottom of the oven door. If this happens, wipe it up at the end of the cycle.
- The door gasket may be wet when the Steam Clean cycle finishes. This is normal. Do not clean the gasket.

NOTE: Water will remain and will be still warm (this is normal) this will need to be wiped up at end of cycle.

NOTE: Minimal temperature 120 °F is allowed for enable steam clean.

Care and cleaning of the oven.

Be sure electrical power is off before cleaning any part of the oven.

How to Remove Protective Shipping Film and Packaging Tape

Carefully grasp a corner of the protective shipping film with your fingers and slowly peel it from the appliance surface. Do not use any sharp items to remove the film. Remove all of the film before using the appliance for the first time.

To assure no damage is done to the finish of the product, the safest way to remove the adhesive from packaging tape on new appliances is an application of a household liquid dishwashing detergent. Apply with a soft cloth and allow to soak.

NOTE: The adhesive must be removed from all parts. It cannot be removed if it is baked on.

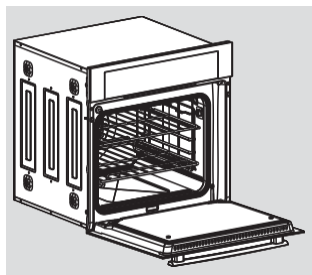

Lift-Off Oven Door

The oven door is removable for easy access to oven cavity. Follow the instructions:

- 1 Full open the door and with the help of this manual, locate the following parts:
 - Hinge arm.
 - Safe Bracket.

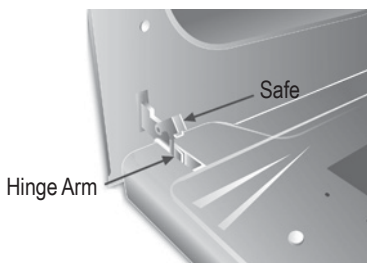

- 2 Lift the safe bracket in each hinge.
- 3 Move the door about 45° and pull it out.

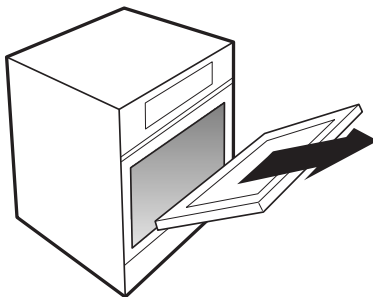

Mounting Oven Door

- 1 Place the door at an angle of approximately 45° and insert the snap hinge compartment located on front frame.
- 2 Open the door fully and return safe bracket in off position in both hinges.

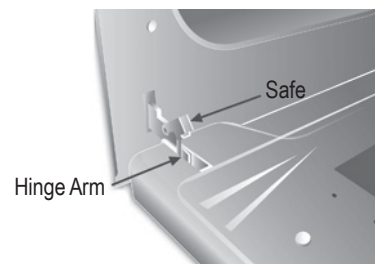

- 3 Completely close the door, until you hear a slight click, this indicates that the door has been mounted correctly.

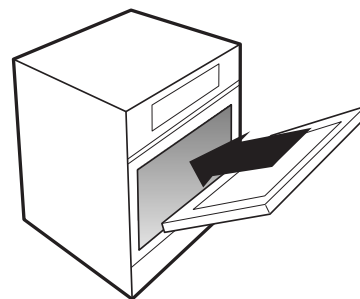

Oven Rack and Accessories.

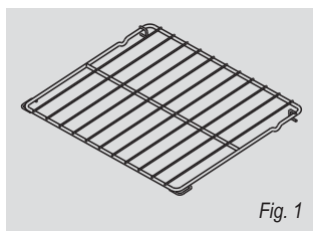

Removing and Installing Oven Racks

Oven Racks

The flat conventional rack (fig. 1) and the full-extension rack (fig. 2) can be installed at any level position into cavity.

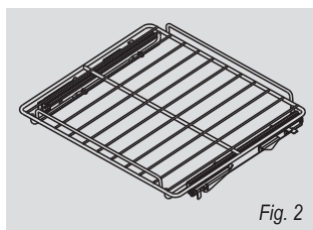

Installing conventional rack

- 1 Insert guides "C" in sides support, these guides are located in the rear of the flat rack. See (fig. 3).
- 2 Pull flat rack into oven cavity.

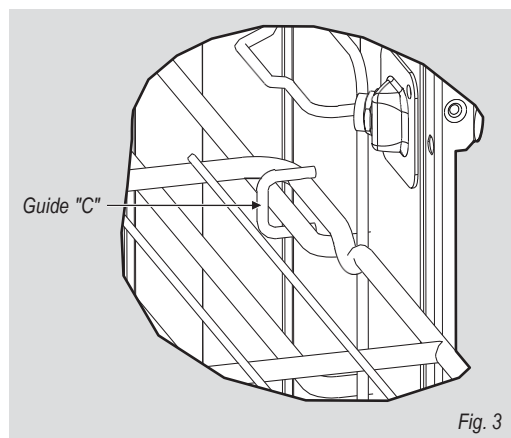

Installing full extension racks

- 1 Insert guide of sliders on wires of oven rack supports. (Fig. 4).
- 2 Slide the rack. Be sure the wire stop is in the cut of the slides. The rails must be fixed.

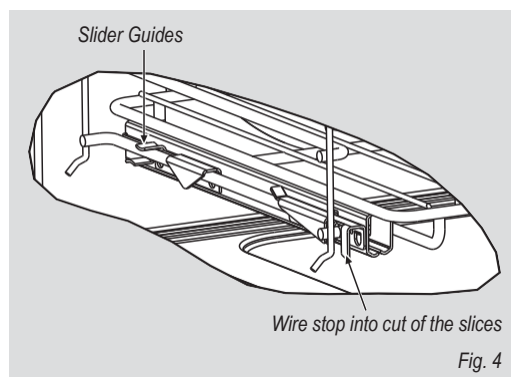

Locate broiler pan

The wall oven has a broiler pan. Use this for roast the food.

! WARNING!

Always place the broiler pan on the oven rack.

Care and cleaning of the oven.

Be sure electrical power is off and all surfaces are cool before cleaning any part of the oven.

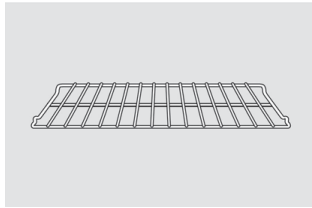

Oven Racks

Clean the oven racks with an abrasive cleanser or steel wool. After cleaning, rinse the racks with clean water and dry with a clean cloth.

To make the racks slide more easily; apply a small amount of vegetable oil or cooking oil to a paper towel and wipe the edges of the oven racks with the paper towel.

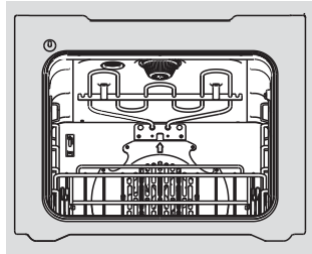

Oven Heating Elements

Do not clean the broil element. Any soil will burn off when the elements are heated.

Control Panel

It is a good idea to wipe the control panel after each use. Clean with mild soap and water or vinegar and water, rinse with clean water and polish dry with a soft cloth.

Do not use abrasive cleansers, strong liquid cleansers, plastic scouring pads or oven cleansers on the control panel-they will damage the finish. A 50/50 solution of vinegar and hot water works well.

Painted Surfaces

Clean with soap and water or a vinegar and water solution.

Do not use commercial oven cleaners cleansing powders, steel wool or harsh abrasives on any painted surface.

Glass Surfaces

To clean the outside glass finish, use a glass cleaner. Rinse and polish with a dry cloth.

Do not allow the water or cleaner to run down inside the oven door while cleaning.

Stainless Steel Surfaces

Do not use a steel wool pad, it will scratch the surface.

To clean the stainless steel surface, use warm sudsy water or a stainless steel cleaner or polish. Always wipe the surface in the direction of the grain. Follow the cleaner instructions for cleaning the stainless steel surface.

Non-Self-Clean Oven Interior

With proper care, the porcelain enamel Finish on the inside of the oven top, bottom, sides, back and inside of the door will stay new looking for years.

Let the oven cool before cleaning. We recommend that you wear rubber gloves when cleaning the oven.

Soap and water will normally do the job. Heavy spattering or spillovers may require cleaning with a mild abrasive cleaner. Soap-filled scouring pads may also be used.

Do not allow food spills with a high sugar or acid content (such as tomatoes, sauerkraut, fruit juices or pie filling) to remain on the surface.

They may cause a dull spot even after cleaning.

Household ammonia may make the cleaning job easier. Place 1/2 cup in a shallow glass or pottery container in a cold oven overnight.

The ammonia fumes will help loosen the burned-on grease and food.

If necessary, you may use an oven cleaner.

Follow the package directions.

- Do not spray oven cleaner on the electrical controls and switches because it could cause a short circuit and result in sparking or fire.
- Do not allow a film from the cleaner to build up on the temperature sensor—it could cause the oven to heat improperly. (The sensor is located at the top of the oven.) Carefully wipe the sensor clean after each oven cleaning, being careful not to move the sensor as a change in its position could affect how the oven bakes.
- Do not spray any oven cleaner on the oven door, handles or any exterior surface of the oven, cabinets or painted surfaces. The cleaner can damage these surfaces.

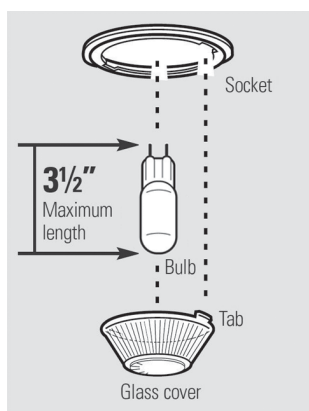

Oven Light Bulb

⚠ CAUTION:

Before replacing your oven light bulb, disconnect the electrical power to the oven at the main fuse or circuit breaker panel.

Be sure to let the light cover and bulb cool completely.

NOTE: The glass cover (on some models) should be removed only when cold. Wearing latex gloves may offer a better grip.

Before replacing the bulb, disconnect electrical power to the oven at the main fuse or circuit breaker panel. Let the bulb cool completely before removing it. For your safety, do not touch a hot bulb with a damp cloth. If you do, the bulb will break.

To remove:

Turn the glass cover counterclockwise 1/4 turn until the tabs of the glass cover clear the grooves of the socket. Remove the bulb.

To replace:

Put in a new 50-watt appliance bulb. Place the tabs of the glass cover into the grooves of the socket. Turn the glass cover clockwise 1/4 turn.

NOTE:

- A 50-watt appliance bulb is smaller than a standard 50-watt household bulb.
- Install and tighten the cover clockwise.
- Reconnect electrical power to the oven.
- For improved lighting inside the oven, clean the glass cover frequently using a wet cloth. This should be done when the oven is completely cool.

Installation instructions.

<h1>Installation Instructions</h1>	<h1>Built-In Wall Oven</h1> <p>24" (61 cm) model</p>
------------------------------------	--

<p>Before You Begin</p> <p>Read these instructions carefully and completely.</p> <ul style="list-style-type: none"> • IMPORTANT— Save these instructions for local inspector’s use. • IMPORTANT— Observe all governing codes and ordinances. • Note to Installer—Be sure to leave these instructions with the consumer. • Note to Consumer—Keep these instructions for future reference. 	<ul style="list-style-type: none"> • Proper installation is the responsibility of the installer and product failure due to improper installation is NOT covered under warranty. • NOTE—This appliance must be properly grounded. • ATTENTION INSTALLER All electric wall ovens must be hard wired (direct wired) into an approved junction box. A plug and receptacle is NOT permitted on these products.
---	--



Important safety instructions

For Your Safety

- Be sure your oven is installed properly by a qualified installer or service technician. Never install the wall oven in a horizontal cabinet.
- Be sure the oven is securely installed in a cabinet that is firmly attached to the house structure. Weight on the oven door could cause the oven to tip and result in injury. Never allow anyone to climb, sit, stand or hang on the oven door.
- Make sure the cabinets and wall coverings around the oven can withstand the temperatures (up to 93°C [200°F]) generated by the oven.



WARNING: *The electrical power to the oven supply line must be shut off while line connections are being made. Failure to do so could result in serious injury or death.*

Electrical Requirements

This appliance must be supplied with the proper voltage and frequency, and connected to an individual, properly grounded branch circuit, protected by a circuit breaker or fuse. See the rating plate located on the oven frame to determine the rating of the product. Use the chart below to determine the minimum recommended dedicated circuit protection.

kW Rating 120V	Recommended Circuit Size (Dedicated)
≤ 1.8 kW	20 Amp

Electrical Requirements (cont.)

Rating Plate location.

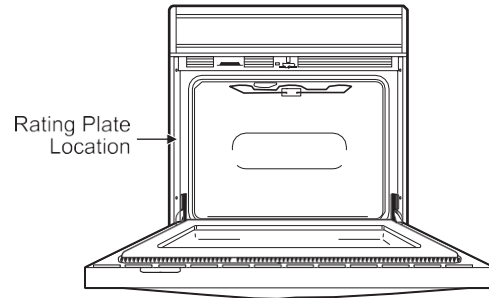

We recommend you have the electrical wiring and hookup of your oven connected by a qualified electrician. After installation, have the electrician show you where your main oven disconnect is located.

Check with your local utilities for electrical codes which apply in your area. Failure to wire your oven according to governing codes could result in a hazardous condition. If there are no local codes, your oven must be wired and fused to meet the requirements of CAN/CSA C22.2 No. O-M91 or latest edition.

You must use a three-wire, single-phase A.C. 120 Volt, 60 hertz electrical system. If you connect to aluminum wiring, properly installed connectors approved for use with aluminum wiring must be used.



Installation instructions.

A Cutout for 24" (61 cm) Single Built-In Ovens only

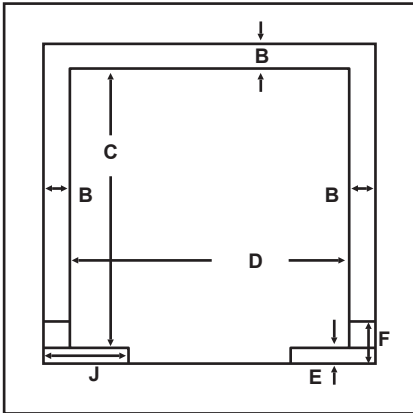

The furniture must support 50 kg (110 lb)

Dim.	24" Single Electric Wall Oven
A	25 in (63.5 cm) min.
B	3/4 in (1,8 cm) min. 13/16 in (2,0) max.
C	23 1/8 in (58,7 cm) min. 23 3/16 in (58,9) max.
D	22 1/8 in (56,1 cm) min. 22 3/16 in (56,4) max.
E	5/16 in (0,8 cm) min. 3/8 in (1,0 cm) max.
F	1 in (2,5 cm) min. 1 1/8 in (2,8 cm) max.
G	11/16 in (1,8 cm) min. 3/4 in (2,0 cm) max.
H	1 1/4 in (3,1 cm) min. 1 3/8 in (3,5 cm) max.
I	2 in (5 cm) min.
J	5 1/2 (14 cm) min.

Allow a minimum of 50.8 cm (20 in) for clearance to adjacent cabinets, drawers, walls, etc. When door is open.

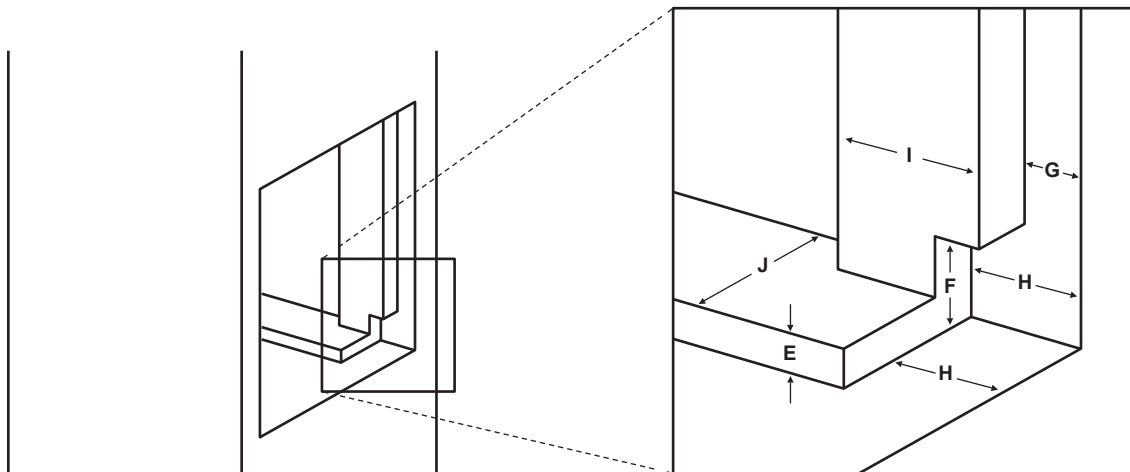
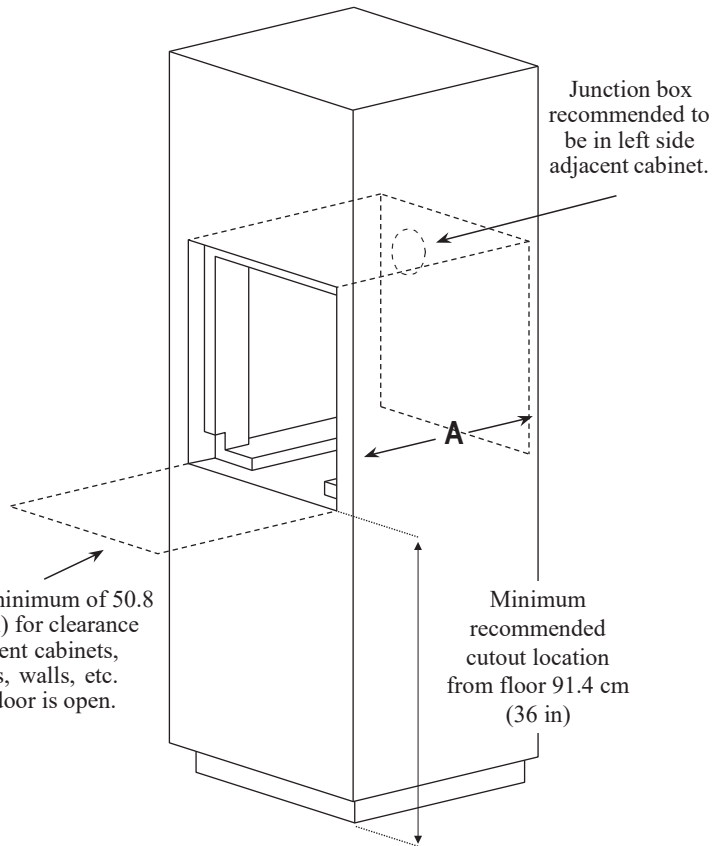

Important safety instructions.

B Electrical Connections

ATTENTION INSTALLER

All electric wall ovens must be hard wired (direct wired) into an approved junction box. A plug and receptacle is NOT permitted on these products.

DO NOT shorten the flexible conduit. The conduit strain relief clamp must be securely attached to the junction box and the flexible conduit must be securely attached to the clamp. If the flexible conduit will not fit within the clamp, do not install the oven until a clamp of the proper size is obtained.

NOTE TO ELECTRICIAN: The 3 power leads supplied with this appliance are CSA recognized for connection to heavier gauge household wiring. The insulation of these 3 leads is rated at temperatures much higher than the temperature rating of household wiring. The current carrying capacity of the conductor is governed by the wire gauge and the temperature rating of the insulation around the wire.



WARNING: Improper connection of aluminum house wiring to copper leads can result in an electrical hazard or fire. Use only connectors designed for joining copper to aluminum and follow the manufacturer's recommended procedure closely.

B1 Turn off the circuit breaker or remove fuses to the oven branch circuit.

B2 With the oven supported on a table or platform in front of the cabinet opening, connect the flexible conduit to the electrical junction box as shown below. Position the conduit in such a manner that it will lie on top of the oven in a natural loop when the oven is installed. You will need to purchase an appropriate strain relief clamp to complete the connection of the conduit to the junction box.

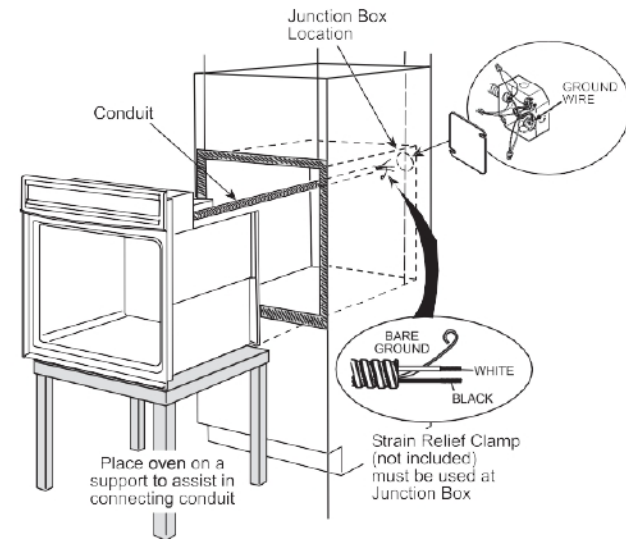

B3 This oven is supplied with a 123 cm (48") long flexible conduit consisting of:

- 2 insulated conductors (copper)
- 1 insulated ground conductor (copper)

B4 Suggestion: Attach conductors to residence wiring as shown by wiring diagram.

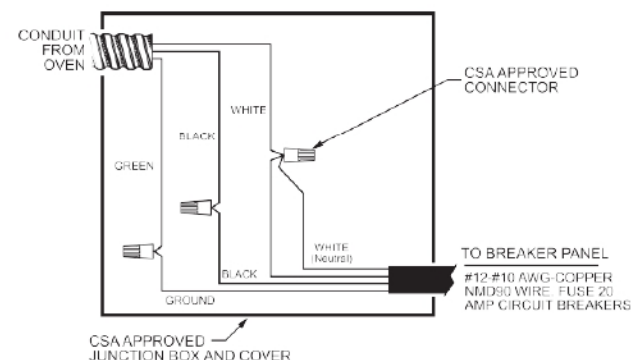

Important safety instructions.

C Securing the Oven in the Opening

Drilling the Pilot Holes and Mounting the Oven

NOTE: Before drilling the pilot holes, make sure the oven is pushed as far back into the opening as it will go and is centered.

- Drill through the mounting holes in front frame, for the #8 screws provided.

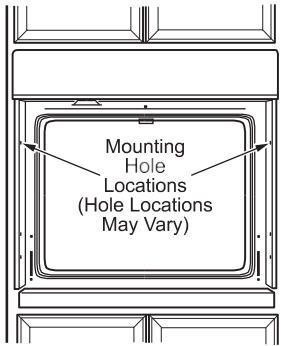

The screws must be a minimum of 6 mm (1/4") from the front of the cutout.



WARNING: Mounting screws must be used. Failure to do so could result in the oven falling out of the cabinet, causing serious injury.

- Secure the oven to cabinet with screws provided.

NOTE: If the cabinet is particle board, you must use #8 x 19 mm (3/4") particle board screws. These may be purchased at any hardware store.

Before you call for service...



Troubleshooting Tips

Save time and money! Review the charts on the following pages first and you may not need to call for service.

Problem	Possible Causes	What To Do
Control signals after entering cooking time or delay start.	You forgot to enter a bake temperature or cleaning time.	<ul style="list-style-type: none"> • Touch the BAKE pad and desired temperature.
Food does not bake or roast properly.	Oven controls improperly set.	<ul style="list-style-type: none"> • See the Using the oven section.
	Rack position is incorrect or the rack is not level.	<ul style="list-style-type: none"> • See the Using the oven section.
	Incorrect cookware or cookware of improper size being used.	<ul style="list-style-type: none"> • See the Using the oven section.
	Oven thermostat needs adjustment.	<ul style="list-style-type: none"> • See the Adjust the oven thermostat—Do it yourself! section.
Food does not broil properly	Door not open to the broil stop position as recommended.	<ul style="list-style-type: none"> • See the <i>Using the oven</i> section.
	Oven controls improperly set.	<ul style="list-style-type: none"> • Make sure you touch the BROIL pad.
	Food being cooked in a hot pan.	<ul style="list-style-type: none"> • For best results, use a pan designed for broiling. Make sure it is cool.
	Cookware not suited for broiling.	<ul style="list-style-type: none"> • For best results, use a pan designed for broiling.
	In some areas the power (voltage) may be low.	<ul style="list-style-type: none"> • Preheat the broil element for 10 minutes.
Clock and timer do not work.	A fuse in your home may be blown or the circuit breaker tripped.	<ul style="list-style-type: none"> • Replace the fuse or reset the circuit breaker.
	Oven controls improperly set.	<ul style="list-style-type: none"> • Set the Using the clock and timer section.
Oven light does not work.	Lightbulb is loose or defective.	<ul style="list-style-type: none"> • Tighten or replace the bulb.
	Pad operating light is broken.	<ul style="list-style-type: none"> • Call for service.
"Burning or oily" odor emitting from the vent	This is normal in a new oven and will disappear in time.	<ul style="list-style-type: none"> • To speed the process, set bake mode for a minimum of 3 hours.

Safety Instructions			
Operating Instructions	Problem	Possible causes	What To Do
	Oven temperature too hot or too cold	Oven thermostat needs adjustment.	<ul style="list-style-type: none"> • See the Adjust the oven thermostat section—Do it yourself.
	Oven will not work	<p>A fuse in your home may be blown or the circuit breaker tripped.</p> <p>Oven controls improperly set.</p>	<ul style="list-style-type: none"> • Replace the fuse or reset the circuit breaker. • See the <i>Using the oven</i> section.
Care and Cleaning	"Cracking" or "popping" sound	This is the sound of the metal heating and cooling during both, the cooking and cleaning functions.	<ul style="list-style-type: none"> • This is normal.
	Excessive smoking during clean cycle	Excessive soil.	<ul style="list-style-type: none"> • Touch the CLEAR/OFF pad. Open the windows to rid the room of smoke. Wait until the LOCKED light goes off. Wipe up the excess soil and reset the clean cycle.
	Oven door will not open after a clean cycle	Oven too hot.	<ul style="list-style-type: none"> • Allow the oven to cool below locking temperature.
Installation Instructions	LOCKED light is on when you want to cook	The oven door is locked because the temperature inside the oven has not dropped below the locking temperature.	<ul style="list-style-type: none"> • Touch the CLEAR/OFF pad. Allow the oven to cool.
Troubleshooting Tips			
Consumer Support			



Problem	Possible Causes	What To Do
"F- and a number or letter" flash in the display	You have a function error code.	<ul style="list-style-type: none"> • Touch the CLEAR/OFF pad. Allow the oven to cool for one hour. Put the oven back into operation.
	If the function code repeats.	<ul style="list-style-type: none"> • Disconnect all power to the oven for at least 30 seconds and then reconnect power. If the function error code repeats, call for service.
Display goes blank	A fuse in your home may be blown or the circuit breaker tripped.	<ul style="list-style-type: none"> • Replace the fuse or reset the circuit breaker.
	The clock is in the black-out mode.	<ul style="list-style-type: none"> • See the <i>Special features of your oven control</i> section.
Display flashes	Power failure.	<ul style="list-style-type: none"> • Reset the clock.
Unable to get the display to show "SF"	Oven control pads were not pressed properly.	<ul style="list-style-type: none"> • The BAKE and BROIL pads must be touched at the same time and held for 3 seconds.
Power outage, clock flashes	Power outage or surge.	<ul style="list-style-type: none"> • Reset the clock. If the oven was in use, you must reset it by touching the CLEAR/OFF pad, setting the clock and resetting any cooking function.
Strong odor	An odor from the insulation around the inside of the oven is normal for the first few times the oven is used.	<ul style="list-style-type: none"> • This is temporary.
Fan noise	A cooling fan may automatically turn on.	<ul style="list-style-type: none"> • This is normal. The cooling fan will turn on to cool internal parts. It may run for up to 30 minutes after the oven is turned off.



Accessories

Looking for something more?

To inquire about purchasing a part or an accessory for your appliance, contact the authorized service center.

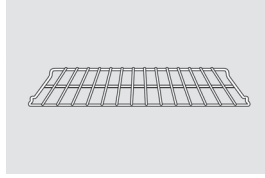

Oven racks

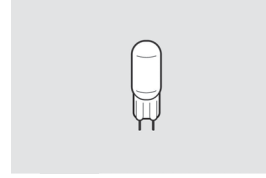

Light Bulbs

Experience these other great products to keep your kitchen looking great!



Ceramic Cooktop
Cleaning Kit: Includes
cleaner, scraper and
pad
WX10X117GCS



Ceramic Cooktop
Cleaning Wipes
WX10X305



Stainless Steel
Appliance Polish
Wipes
WX10X100001



Stainless Steel
Appliance Cleaner
PM10X311

Broiler Pan

Use your pan and grid cover to broil hamburgers, seafood, steaks, vegetables, bacon, chops and so much more! The pan below catches the excess fats and oils.

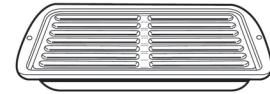



Felix Storch, Inc.
 An ISO 9001:2015 registered company
 770 Garrison Ave
 Bronx, New York 10474
 www.summitappliance.com

PARTS AND LABOR WARRANTY INFORMATION

SUMMIT Appliances are manufactured to provide outstanding value, and your satisfaction is our goal on every product. All SUMMIT major appliances carry a one-year limited warranty on both parts and labor. All refrigerators and freezers carry an additional four years on the compressor. Certain exclusions may apply.

GENERAL PARTS AND LABOR WARRANTY

Summit warrants, to the original purchaser of every new unit, that the cabinet and all parts thereof be free from defects in material or workmanship, under normal and proper use and maintenance service as specified by Summit and upon proper installation and start-up in accordance with the instruction packet supplied with each Summit unit. Summit’s obligation under this warranty is limited to a period of 12 months from the date of original purchase.

Any parts, covered under this warranty, that are determined by Summit to have been defective, within the above said period, are limited to the repair or replacement, including labor charges, of defective parts or assemblies. The labor warranty shall include pre-approved standard straight time labor charges only and reasonable travel time, as determined by Summit.

WARRANTY CLAIMS

All claims for labor or parts must be made directly through Summit. All claims should include: model number of the unit, the serial number of the cabinet, proof of purchase, date of installation, and all pertinent information supporting the existence of the alleged defect. All claims should be filed within 30 days of completed repair or the warranty claim could be refused.

THINGS NOT COVERED BY THIS WARRANTY

Summit’s sole obligation under this warranty is limited to either repair or replacement of parts, subject to the additional limitations below. This warranty neither assumes nor authorizes any person to assume obligations other than those expressly covered by this warranty.

- **NO CONSEQUENTIAL DAMAGES:** Summit is not responsible for economic loss; profit loss; or special, direct, indirect, or consequential damages, including without limitation, losses or damages arising from food or product spoilage claims whether or not on account of refrigeration failure.
- **WARRANTY IS NOT TRANSFERRABLE:** This warranty is not assignable and applies only in favor of the original purchaser/user to whom delivered. Any such assignment or transfer shall void the warranties herein made and shall void all warranties, express or implied, including any warranty of merchantability or fitness for a particular purpose.
- **IMPROPER USE:** Summit assumes no liability for parts or labor coverage for component failure or other damages resulting from improper usage or installation or failure to clean and/or maintain product as set forth in the warranty packet provided with the unit.
- **ALTERATION, NEGLIGENCE, ABUSE, MISUSE, ACCIDENT, DAMAGE DURING TRANSIT OR INSTALLATION, FIRE, FLOOD, ACTS OF GOD:** Summit is not responsible for the repair or replacement of any parts that Summit determines have been subjected after the date of manufacture to alteration, neglect, abuse, misuse, accident, damage during transit or installation, fire, flood, or act of God.
- **IMPROPER ELECTRICAL CONNECTIONS:** Summit is not responsible for the repair or replacement of failed or damaged components resulting from electrical power failure, the use of extension cords, low voltage, or voltage drops to the unit.



Safety Instructions
Operating Instructions
Instructions
Installation
Troubleshooting Tips
Consumer Support

- **NO IMPLIED WARRANTY OF MERCHANTABILITY OR FITNESS FOR A PARTICULAR PURPOSE:** There are no other warranties, expressed, implied or statutory, except the parts & labor warranty specifically described above. These warranties are exclusive and in lieu of all other warranties, including implied warranty and merchantability or fitness for a particular purpose. There are no other warranties which extend beyond the description on the face hereof.
- **OUTSIDE UNITED STATES:** This warranty does not apply to, and Summit is not responsible for, any warranty claims made on products sold or used outside the United States.

REQUESTING SERVICE

If you are in need of service, please either fill out a service request on our website, <http://www.summitappliance.com/support>, or call us at 800-932-4267 or 718-893-3900. Please be prepared to give us the following information: your name, address, phone, email, model, serial, date of purchase, place of purchase, and the problem you are having.



WARNING: This product can expose you to chemicals including Nickel (Metallic) which is known to the State of California to cause cancer.

For more information go to www.P65Warnings.ca.gov

Note: Nickel is a component in all stainless steel and some other metallic compositions.



For parts and accessory ordering, troubleshooting and helpful hints, visit:
www.summitappliance.com/support

