



WASHER/DRYER USE AND CARE GUIDE

Table of Contents

WASHER/DRYER SAFETY	2
WHAT'S NEW UNDER THE LID?	4
CHECK YOUR VENT SYSTEM FOR GOOD AIRFLOW	5
CONTROL PANELS AND FEATURES	6
WASHER CYCLE GUIDE	8
DRYER CYCLE GUIDE	9
USING YOUR WASHER	10
USING YOUR DRYER	13
WASHER/DRYER MAINTENANCE	14
TROUBLESHOOTING	18
WARRANTY	25
ASSISTANCE OR SERVICE	Back Cover

LAVEUSE/SÉCHEUSE GUIDE D'UTILISATION ET D'ENTRETIEN

Table des matières

SÉCURITÉ DE LA LAVEUSE/SÉCHEUSE	26
QUOI DE NEUF SOUS LE COUVERCLE?	28
VÉRIFICATION D'UNE CIRCULATION D'AIR ADÉQUATE POUR LE SYSTÈME D'ÉVACUATION	29
TABLEAUX DE COMMANDE ET CARACTÉRISTIQUES	30
GUIDE DE PROGRAMMES DE LA LAVEUSE	32
GUIDE DE PROGRAMMES DE LA SÉCHEUSE	33
UTILISATION DE LA LAVEUSE	34
UTILISATION DE LA SÉCHEUSE	37
ENTRETIEN DE LA LAVEUSE/SÉCHEUSE	39
DÉPANNAGE	44
GARANTIE	55
ASSISTANCE OU SERVICE	Couverture arrière



Designed to use only HE High Efficiency detergents.
Conçue pour utiliser un détergent haute efficacité seulement.

W11107884A
W11107887A-SP

WASHER/DRYER SAFETY

Your safety and the safety of others are very important.

We have provided many important safety messages in this manual and on your appliance. Always read and obey all safety messages.



This is the safety alert symbol.

This symbol alerts you to potential hazards that can kill or hurt you and others.

All safety messages will follow the safety alert symbol and either the word “DANGER” or “WARNING.” These words mean:

⚠ DANGER

You can be killed or seriously injured if you don't immediately follow instructions.

⚠ WARNING

You can be killed or seriously injured if you don't follow instructions.

All safety messages will tell you what the potential hazard is, tell you how to reduce the chance of injury, and tell you what can happen if the instructions are not followed.



WARNING - “Risk of Fire”

- Clothes dryer installation must be performed by a qualified installer.
- Install the clothes dryer according to the manufacturer’s instructions and local codes.
- Do not install a clothes dryer with flexible plastic venting materials or flexible metal (foil type) duct. If flexible metal duct is installed, it must be of a specific type identified by the appliance manufacturer as suitable for use with clothes dryers. Flexible venting materials are known to collapse, be easily crushed, and trap lint. These conditions will obstruct clothes dryer airflow and increase the risk of fire.
- To reduce the risk of severe injury or death, follow all installation instructions.
- Save these instructions.

IMPORTANT SAFETY INSTRUCTIONS

When discarding or storing your old clothes dryer, remove the door.

SAVE THESE INSTRUCTIONS

IMPORTANT SAFETY INSTRUCTIONS

WARNING: To reduce the risk of fire, electric shock, or injury to persons when using the washer/dryer, follow basic precautions, including the following:

- Read all instructions before using the washer/dryer.
- Do not place items exposed to cooking oils in your dryer. Items contaminated with cooking oils may contribute to a chemical reaction that could cause a load to catch fire.
- Do not wash or dry articles that have been previously cleaned in, washed in, soaked in, or spotted with gasoline, dry-cleaning solvents, other flammable, or explosive substances as they give off vapors that could ignite or explode.
- Do not add gasoline, dry-cleaning solvents, or other flammable, or explosive substances to the wash water. These substances give off vapors that could ignite or explode.
- Do not allow children to play on or in the washer/dryer. Close supervision of children is necessary when the washer/dryer is used near children.
- Before the washer/dryer is removed from service or discarded, remove the doors to the washer/dryer compartments.
- Do not reach into the washer/dryer if the tub, agitator or drum is moving.
- Do not install or store the washer/dryer where it will be exposed to the weather.
- Do not tamper with controls.
- Clean dryer lint screen before or after each load.
- Under certain conditions, hydrogen gas may be produced in a hot water system that has not been used for 2 weeks or more. HYDROGEN GAS IS EXPLOSIVE. If the hot water system has not been used for such a period, before using the washing machine, turn on all hot water faucets and let the water flow from each for several minutes. This will release any accumulated hydrogen gas. As the gas is flammable, do not smoke or use an open flame during this time.
- Do not repair or replace any part of the washer/dryer or attempt any servicing unless specifically recommended in this Use and Care Guide or in published user-repair instructions that you understand and have the skills to carry out.
- Do not use fabric softeners or products to eliminate static unless recommended by the manufacturer of the fabric softener or product.
- Do not use heat to dry articles containing foam rubber or similarly textured rubber-like materials.
- Keep area around the exhaust opening and adjacent surrounding areas free from the accumulation of lint, dust, and dirt.
- The interior of the machine and dryer exhaust vent should be cleaned periodically by qualified service personnel.
- See “Electrical Requirements” section of the Installation Instructions booklet for grounding instructions.

SAVE THESE INSTRUCTIONS

State of California Proposition 65 Warnings:

WARNING: This product contains one or more chemicals known to the State of California to cause cancer.

WARNING: This product contains one or more chemicals known to the State of California to cause birth defects or other reproductive harm.

WHAT'S NEW UNDER THE LID?

Your new washer will operate differently than your past agitator-style washer.

Lid Lock

To allow for higher spin speeds, the lid will lock and the Lid Lock light will turn on. When this light is lit, the lid is locked and cannot be opened. When this light is blinking, the washer is paused. When this light is off, the lid can be opened. After a cycle is started, the washer will fill to the appropriate water level. When the washer is done filling, it will start to agitate. If you need to open the lid to add a garment after this point, the lid will remain unlocked during the entire agitation portion of the wash phase. The cycle will automatically pause when the lid is opened, and the cycle will resume once the lid is closed and you press the Start/Pause button. The lid will lock before the spin phase begins. If you need to pause or stop after this point, you must press the START/PAUSE button and wait for the lid to unlock. The lid will only unlock after washer movement has stopped. Depending on when in the cycle you try to pause, it may take several seconds to several minutes for the lid to unlock (for example, 1 minute if the cycle is in the spin phase). Press the START/PAUSE button to resume the cycle.

Sounds

At different stages of the wash cycle, you may hear sounds and pauses that are different from those of your previous washer. For example, you may hear a clicking and hum at the beginning of the spin phase as the lid lock goes through a self-test. There will be different kinds of humming and whirring sounds as the washplate tests for load balance or moves the load. And sometimes, you may hear nothing at all as the washer determines the correct water level for your load or allows time for clothes to soak.

IMPORTANT: The lid must be closed before the washer basket fills with water and for the wash cycle to start. If the lid is open and filling stops, close the lid and press the START/PAUSE button to complete the cycle.

Choosing the Right Detergent

Use only High Efficiency detergents. The package will be marked "HE" or "High Efficiency." Using non-HE detergent will likely result in longer cycle times and reduced rinsing performance. It may also result in component malfunction and, over time, buildup of mold or mildew. HE detergents should be low-sudsing and quick-dispersing to produce the right amount of suds for the best performance. They should hold soil in suspension so it is not redeposited onto clean clothes. Not all detergents labeled as High Efficiency are identical in formulation and their ability to reduce suds. For example, natural, organic, or homemade HE detergents may generate a high level of suds. Always follow the detergent manufacturer's instructions to determine the amount of detergent to use.



Use only High Efficiency (HE) detergent.

CHECK YOUR VENT SYSTEM FOR GOOD AIRFLOW

⚠ WARNING



Fire Hazard

Use a heavy metal vent.

Do not use a plastic vent.

Do not use a metal foil vent.

Failure to follow these instructions can result in death or fire.

Good airflow

Along with heat, dryers require good airflow to efficiently dry laundry. Proper venting will reduce your drying times and improve your energy savings. See Installation Instructions.

The venting system attached to the dryer plays a big role in good airflow.

Service calls caused by improper venting are not covered by the warranty and will be paid by the customer, regardless of who installed the dryer.

Maintain good airflow:

- Clean your lint screen before each load.
- Replace plastic or foil vent material with 4" (102 mm) diameter heavy, rigid vent material.

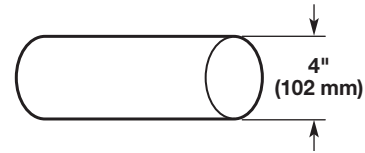

- Use the shortest length of vent possible.
- Use no more than four 90° elbows in a vent system; each bend and curve reduces airflow.

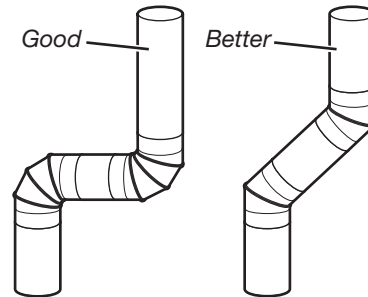

- Remove lint and debris from the exhaust hood.
- Remove lint from the entire length of the vent system at least every 2 years. When cleaning is complete, be sure to follow the Installation Instructions supplied with your dryer for final product check.
- Clear away items from the front of the dryer.

Use Automatic cycles for better fabric care and energy savings

Use the Automatic Dry cycles to provide the most energy savings and enhanced fabric care from the dryer. During Automatic Dry cycles, drying air temperature or moisture level are sensed in the load. This sensing occurs throughout the drying cycle, and the dryer shuts off when the load reaches the selected dryness.

With Timed Drying, the dryer runs the amount of time set and sometimes results in shrinkage, wrinkling, and static due to overdrying. Use Timed Drying for the occasional damp load that needs a little more drying time.

CONTROL PANELS AND FEATURES

WASHER

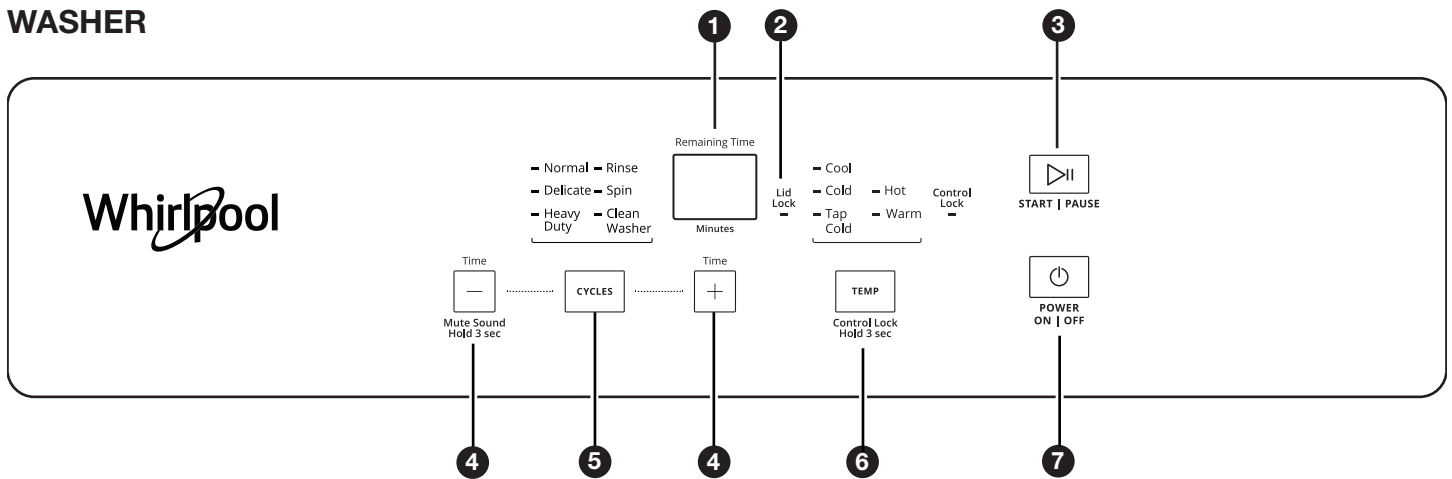

1 LED TIME/STATUS DISPLAY

The Remaining Time display shows the time required for the cycle to complete. Factors such as load size and water pressure may affect the time shown in the display. Tightly packed loads, unbalanced loads, excessive suds, or adding or removing items may cause the washer to adjust the cycle time as well.

2 LID LOCK LIGHT

The Lid Lock indicator lights up when the lid is locked and cannot be opened. If you need to open the lid, press and hold START/PAUSE. The lid will unlock 1 minute after the washer movement has stopped. This may take several minutes if the load was spinning at high speed. Press the START/PAUSE button again to restart the cycle.

3 START/PAUSE

After selecting a wash cycle, press START/PAUSE to start the cycle. Press once to pause a cycle. The flashing lights indicate the selected cycle and the current process.

4 CYCLE TIME (+ or -)

- Press “+” or “-” to adjust the duration of a cycle.
- LED display will show the time remaining for the cycle to complete.
- If an out-of-range adjustment is made, a buzzer will sound.

End-of-Cycle Signal

Press and hold the plus (+) button for 3 seconds to enable or disable the end-of-cycle signal.

Press and hold the minus (-) button for 3 seconds to mute the signal.

5 CYCLES

Press CYCLES to select a wash cycle. Choose from Normal, Delicate, Heavy Duty, Rinse, Spin, or Clean Washer.

6 TEMP

Select a wash temperature based on the type of fabric and soils being washed. For best results and following the garment label instructions, use the warmest wash water safe for your fabric.

CONTROL LOCK

Press and hold TEMP for 3 seconds to lock the controls. Press and hold for 3 seconds to unlock. You may still press POWER ON/OFF to turn off the washer.

7 POWER ON/OFF

Press POWER ON/OFF to turn on or off the washer. Press once while a cycle is running to stop the washer.

DRYER
240V MODELS

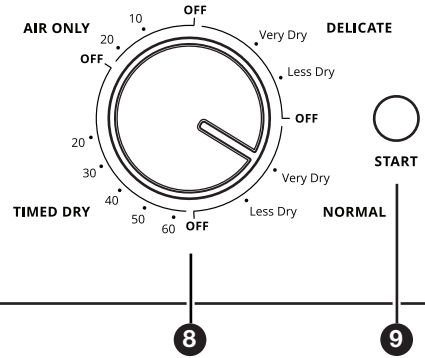

120V MODELS

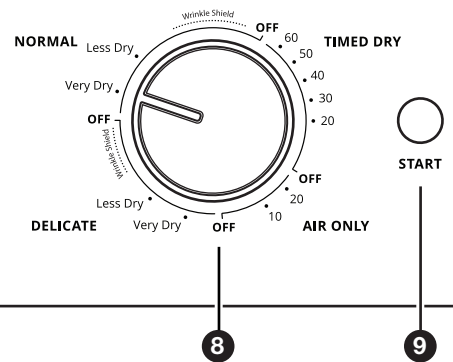

8 DRYER CYCLE KNOB
Use your Dryer Cycle knob to select available cycles on your dryer. Turn the knob to select a cycle for your laundry load. See “Dryer Cycle Guide” for detailed descriptions of cycles.

TIMED DRY

Will run the dryer for the specified time on the control. Drying time and temperature will depend on your dryer model.

NORMAL and DELICATE CYCLES

These cycles sense moisture in the load or air temperature and shut off when the load reaches the selected dryness level. They give the best drying in the shortest time. Drying time will vary based on fabric type, load size, and dryness setting.

AIR ONLY

This cycle will run the dryer without heat for the specified time on the control.

9 START BUTTON
Press the START button to start the dryer.

DISPENSERS

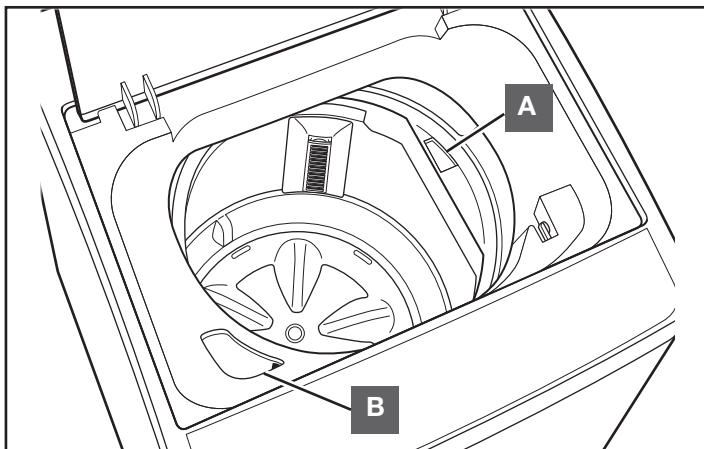

A Liquid fabric softener dispenser
Pour measured liquid fabric softener into the liquid fabric softener dispenser if desired. It will dispense automatically at the optimum time.

■ Use only liquid fabric softener in this dispenser.

NOTE: The fabric softener dispenser rotates around the wash basket and may not be in the same spot each time.

B Liquid chlorine bleach dispenser
This dispenser holds up to 3/4 cup (180 mL) liquid chlorine bleach. The bleach will be automatically diluted and dispensed at the optimum time during the wash cycle. This dispenser cannot dilute powdered bleach.

NOTE: Fill dispenser with only liquid bleach.



WASHER CYCLE GUIDE

Each cycle listing includes a performance chart rating its cleaning power, gentleness on items, and resource efficiency. Not all cycles or options are available on all models. Refer to the CYCLES button on your washer.

Wash temperatures are selected using the Temp button.

For best performance:

- Choose the cycle that best fits the load being washed.
- Decrease or increase the maximum target water temperature for any cycle.
- Do not leave the washer lid open unattended once the washer has started to fill.

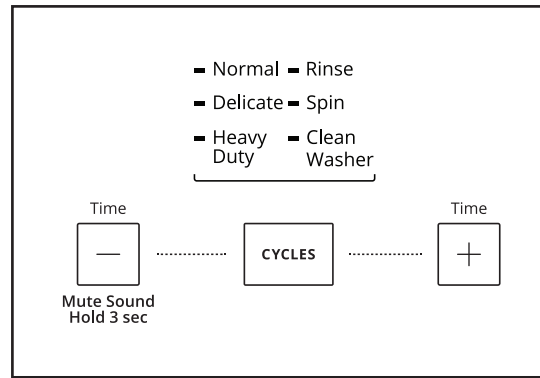

Items to wash:	Cycle:	Load Size:	Wash Time/Spin Speed:	Cycle Details:
Cottons, linens, and mixed-garment loads	Normal		Medium/High	Use this cycle for normally soiled cottons and linens. Wash combines a medium wash time and a high-speed spin to shorten drying time. Good Best Cleaning Gentleness Efficiency†
Machine-wash silks, hand-washed fabrics	Delicate		Short/High	Use this cycle for lingerie and loosely knit items. Wash combines a short wash time for gentle soil removal, and a high-speed spin to shorten drying time. Good Best Cleaning Gentleness Efficiency†
Sturdy fabrics, colorfast items, towels, jeans	Heavy Duty		Long/High	Use this cycle for sturdy or heavily soiled loads, or when using bleach. Wash combines a long wash time, two rinses, and a high-speed spin for maximum soil removal. Good Best Cleaning Gentleness Efficiency†
Swimsuits and items requiring rinsing without detergent	Rinse	N/A	N/A	Use this cycle for additional rinsing of the washer load or hand-washed items. This cycle uses some agitation and finishes with a high-speed spin.
Hand-washed garments or dripping-wet items	Spin	N/A	N/A/High	Use this cycle to remove excess water from the washer load or hand-washed items.
No clothes in washer	Clean Washer	N/A	Short/N/A	Use this cycle every 30 washes to keep the inside of your washer fresh and clean. This cycle uses a higher water level. Use with affresh® washer cleaner tablet or regular liquid chlorine bleach to thoroughly clean the inside of your washer. This cycle should not be interrupted. See "Washer Care." IMPORTANT: Do not place garments or other items in the washer during the Clean Washer cycle. Use this cycle with an empty wash tub. Do not use thickened, easy-pour, or no-splash bleach when running the Clean Washer cycle as excess suds may occur. See "Washer Care" in "Washer/Dryer Maintenance."

†Efficient use of resources, such as energy and water.

IMPORTANT: Do not presoak items in your washer by lifting the lid or stopping the cycle. Failure to follow this instruction can result in property damage. If needed, presoak items in a small wash basin prior to loading the washer.



DRYER CYCLE GUIDE – AUTOMATIC DRY CYCLES

Not all cycles and settings are available on all models.

Both the Normal and Delicate cycles are automatic dry cycles. They give the best drying in the shortest time. These cycles sense moisture in the load or air temperature and shut off when the load reaches the selected dryness level. Drying time varies based on fabric type, load size, and dryness setting.

Select either the Normal or Delicate cycle based on the fabrics in your load. If you are unsure of the cycle to select for a load, select the Delicate cycle (lower temperature) rather than the Normal cycle (higher temperature).

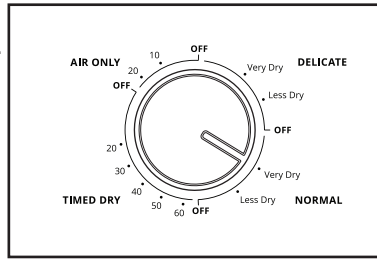

240V Models

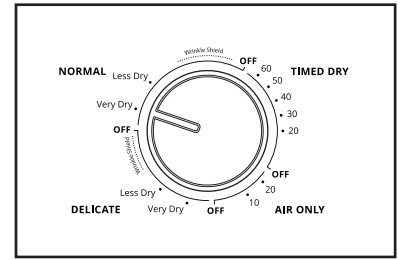

120V Models

WRINKLE SHIELD™ OPTION (120V models)

This feature will run after your drying cycle is complete. It periodically starts and stops the dryer, tumbling the load without heat to help avoid wrinkling.

Items to dry:	Cycle:	Available Options:	Cycle Details:
Corduroys, work clothes	Normal	None	Medium to large loads of mixed fabrics and items.
Lingerie, blouses, washable knit fabrics	Delicate	None	For gently drying delicate items.

NOTE: If loads do not seem as dry as you would like, select Very Dry next time you dry a similar load. If loads seem drier than you like, select Less Dry next time you dry a similar load.

DRYER CYCLE GUIDE – TIMED DRYING

Not all cycles and settings are available on all models.

Timed Dry will allow the dryer to run for the selected time.

Items to dry:	Cycle:	Temperature:	Available Options:	Cycle Details:
Rubber, plastic, heat-sensitive fabrics	Air Only	No Heat	Time Adjustment	For airing out, refreshing, and loosening up laundry without heating.
Heavy, bulky, or lightweight items	Timed Dry	High	Time Adjustment	Completes drying if items are still damp.

NOTE: Government energy certifications for this model were based on the Timed Dry cycle with the Maximum drying temperature setting. The as-shipped defaults of Normal cycle, Less Dry, and the Wrinkle Shield™ option (when applicable) were not used.

USING YOUR WASHER

⚠ WARNING



Fire Hazard

Never place items in the washer that are dampened with gasoline or other flammable fluids.

No washer can completely remove oil.

Do not dry anything that has ever had any type of oil on it (including cooking oils).

Doing so can result in death, explosion, or fire.

⚠ WARNING



Electrical Shock Hazard

Plug into a grounded 3 prong outlet.

Do not remove ground prong.

Do not use an adapter.

Do not use an extension cord.

Failure to follow these instructions can result in death, fire, or electrical shock.

1. Sort and prepare your laundry

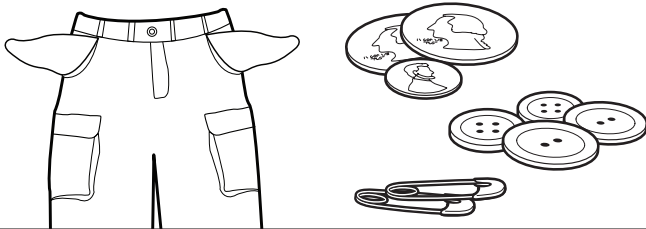

- Empty pockets. Loose change, buttons, or any small object can pass under the agitator and become trapped, causing unexpected sounds.
- Sort items by recommended cycle, water temperature, and colorfastness.
- Separate heavily soiled items from lightly soiled.
- Separate delicate items from sturdy fabrics.
- Do not dry garments if stains remain after washing, because heat can set stains into fabric.
- Treat stains promptly.
- Close zippers, fasten hooks, tie strings and sashes, and remove non-washable trim and ornaments.
- Mend rips and tears to avoid further damage to items during washing.

Helpful Tips:

- When washing waterproof or water-resistant items, load evenly.
- Use mesh garment bags to help avoid tangling when washing delicate or small items.
- Turn knits inside out to avoid pilling. Separate lint-takers from lint-givers. Synthetics, knits, and corduroy fabrics will pick up lint from towels, rugs, and chenille fabrics.

NOTE: Always read and follow fabric care label instructions to avoid damage to your garments.

2. Add laundry products

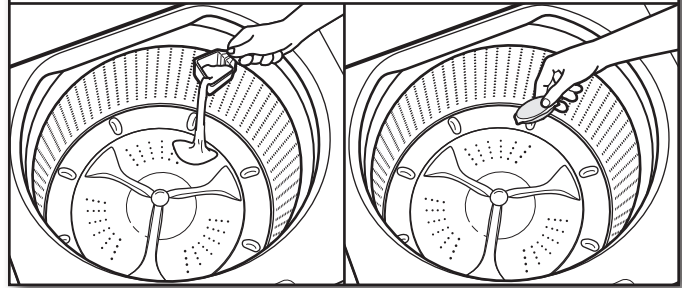

IMPORTANT: Add a measured amount of detergent or single-dose laundry packet into the basket.

If you are using color-safe bleach, Oxi-type boosters, or fabric softener crystals, add to the wash basket prior to adding laundry.

NOTE: Follow the manufacturer's instructions to determine the amount of laundry products to use. Manufacturer suggests using HE detergent.

3. Load laundry into washer

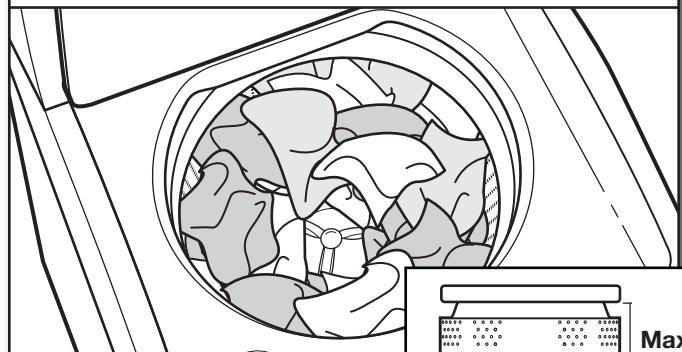

For best performance, load items in loose heaps evenly around the washplate. Try mixing different-sized items to reduce tangling.

IMPORTANT: Items need to move freely for best cleaning and to reduce wrinkling and tangling.

NOTE: The maximum volume is about 1.52 cubic ft. (4.4 lb max. load size per cubic ft.).

4. Add liquid chlorine bleach to dispenser

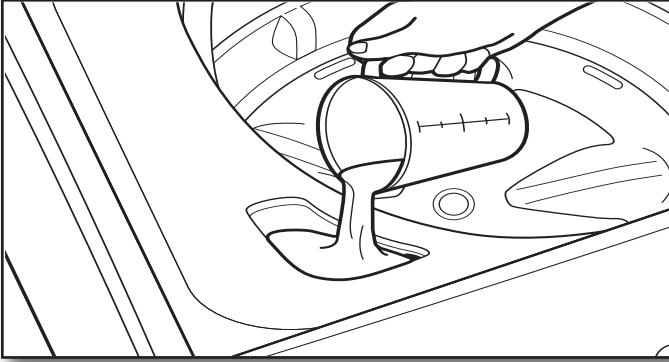

Bleach will be dispensed automatically during the wash part of the cycle. Do not overfill, dilute, or use more than 1 cup (236 mL). Do not use color-safe bleach or Oxi products in the same cycle with liquid chlorine bleach.

5. Add liquid fabric softener

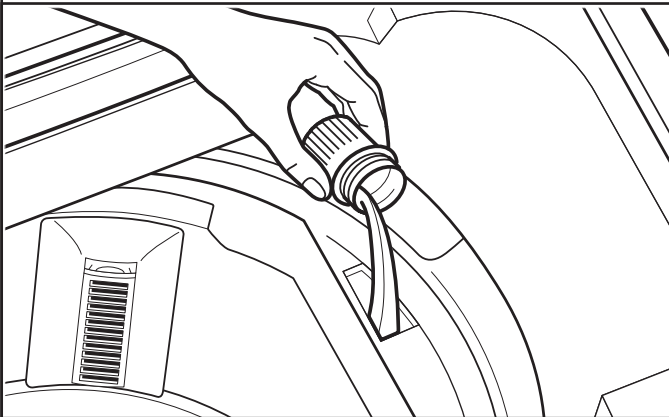

Pour a measured amount of liquid fabric softener into dispenser; always follow manufacturer's directions for correct amount of fabric softener based on your load size. Fabric Softener is added during rinse.

IMPORTANT: Do not overfill or dilute. Overfilling dispenser will cause fabric softener to immediately dispense into washer. It is normal for a small amount of water to remain in the dispenser at the end of a cycle.

NOTE: The fabric softener dispenser rotates around the wash basket and may not be in the same spot each time.

6. Press POWER ON/OFF to turn on washer



Close the washer lid. Washer will not fill, agitate, or spin with the lid open. Make sure the dispenser drawer is closed completely; then press POWER ON/OFF to turn on the washer.

7. Select wash TEMP

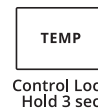
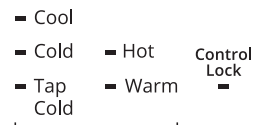

Set the water temperature for the type of fabric and soils being washed. Use the warmest wash water safe for fabric. Follow garment label instructions.

The Rinse and Spin cycles default to a cold rinse; all other cycles default to a warm rinse. Press the TEMP button to choose a different wash temperature.

Selecting Water Temperatures

NOTE: Always read and follow fabric care label instructions to avoid damage to your garments.

Wash Temp	Suggested Fabrics
Hot Some cold water is added to save energy. This will be cooler than your hot water heater setting.	Whites and pastels Durable garments Heavy soils
Warm Some cold water will be added, so this will be cooler than what your previous washer provided.	Bright colors Moderate to light soils
Cool Some warm water may be added to assist in soil removal and to help dissolve detergents.	Colors that bleed or fade Light soils
Cold A small amount of warm water may be added to assist in soil removal and to help dissolve detergents. Water will be colder than "Cool" setting.	Dark colors that bleed or fade Light soils
Tap Cold This is the temperature from your faucet.	Dark colors that bleed or fade Light soils

NOTE: In wash water temperatures colder than 60°F (15.6°C), detergents do not dissolve well. Soils can be difficult to remove. Some fabrics can retain wear wrinkles and have increased pilling (the formation of small lint-like balls on the surface of garments).

8. Select CYCLES

■ Normal ■ Rinse
■ Delicate ■ Spin
■ Heavy Duty ■ Clean Washer

Time

-

Mute Sound
Hold 3 sec

CYCLES

Time

+

Press the CYCLES button to select your wash cycle. See "Cycle Guide" for details on cycle features.

9. Press START/PAUSE to begin wash cycle

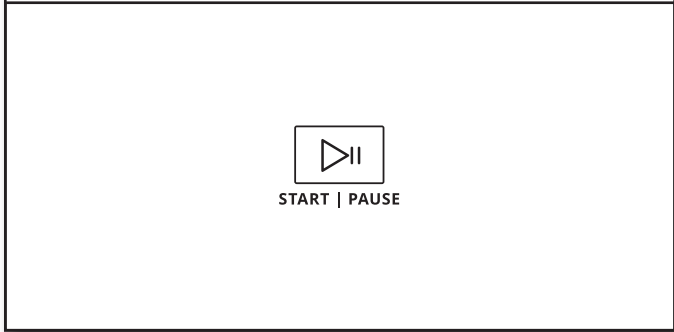

Press the START/PAUSE button to start the wash cycle. When the cycle has finished, the end-of-cycle signal will sound (if set). Wait 1 minute for the lid to unlock. Promptly remove items when cycle is done to avoid odor, reduce wrinkling, and reduce rusting of metal hooks, zippers, and snaps.

Unlocking the lid to add items

If you need to open the lid to add one or two missed items: Press the START/PAUSE button to pause the washer; the lid will unlock once the washer movement has stopped. This may take several minutes if the load was spinning at a high speed. Then close the lid and press the START/PAUSE button again to restart the cycle.

To stop or restart your washer:

- To stop the washer at any time, press the START/PAUSE button and the cycle will pause.
- To restart the washer, press the START/PAUSE button and the cycle will resume.

NOTE: If the washer is paused while in the spin phase, the lid will unlock after 1 minute. During that minute, the Start/Pause button will be disabled.

USING YOUR DRYER

⚠ WARNING



Explosion Hazard

Keep flammable materials and vapors, such as gasoline, away from dryer.

Do not dry anything that has ever had anything flammable on it (even after washing).

Failure to follow these instructions can result in death, explosion, or fire.

WARNING: To reduce the risk of fire, electric shock, or injury to persons, read the Important Safety Instructions before operating this dryer.

Before using your dryer, wipe the dryer drum with a damp cloth to remove dust from storing and shipping.

1. Clean the lint screen

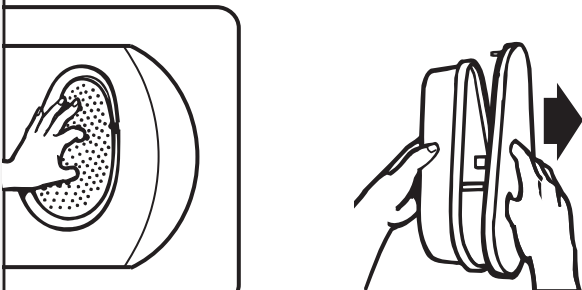

Clean the lint screen before each load.

Reach inside the drum and pull out the lint screen and its cover. Separate the cover and the screen by squeezing the screen and pulling on the cover at the same time. Roll lint off the screen with your fingers. Put the lint screen and its cover back together and push firmly into place.

Do not rinse or wash screen to remove lint. For additional cleaning information, see "Cleaning the lint screen."

2. Load the dryer

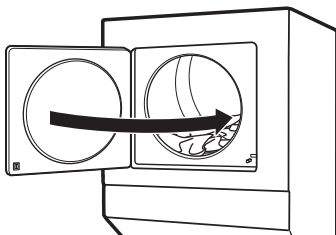

Place laundry in the dryer. Close the door.

Do not tightly pack the dryer; clothes should be able to tumble freely.

⚠ WARNING



Fire Hazard

No washer can completely remove oil.

Do not dry anything that has ever had any type of oil on it (including cooking oils).

Items containing foam, rubber, or plastic must be dried on a clothesline or by using an Air Cycle.

Failure to follow these instructions can result in death or fire.

3. Select cycle

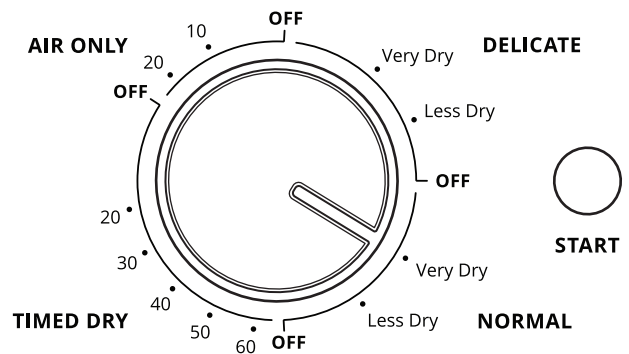

Select the desired cycle for your load. See "Dryer Cycle Guide" for more information about each cycle.

Normal and Delicate Cycles

You can select a different dryness level, depending on your load, by turning the knob to the desired dryness level.

Selecting Very Dry or Less Dry automatically adjusts the dryness level at which the dryer will shut off. Once a dryness level is set, it cannot be changed without stopping the cycle.

These automatic dry cycles give the best drying in the shortest time. Drying time varies based on fabric type, load size, and dryness setting.

NOTE: Very Dry removes more load moisture. Less Dry removes less moisture and is used for loads you may want to put on a hanger to complete drying.

4. Press START button to begin cycle



Push and hold the START button to begin the cycle.

Promptly remove garments after cycle has completed to reduce wrinkling.

WASHER/DRYER MAINTENANCE

WATER INLET HOSES

Replace inlet hoses after 5 years of use to reduce the risk of hose failure. Periodically inspect and replace inlet hoses if bulges, kinks, cuts, wear, or leaks are found.

When replacing your inlet hoses, mark the date of replacement on the label with a permanent marker.

WASHER CARE

Recommendations to Help Keep Your Washer Clean and Performing at Its Best

1. Always use High Efficiency Detergents and follow the detergent manufacturer's instructions regarding the amount of detergent to use. Never use more than the recommended amount because that may increase the rate at which detergent and soil residue accumulate inside your washer, which in turn may result in undesirable odor.
2. Use warm and hot wash water settings sometimes (not exclusively cold water washes), because they do a better job of controlling the rate at which soils and detergent accumulate.
3. Always leave the washer lid open between uses to help dry out the washer and prevent the buildup of odor-causing residue.

Cleaning Your Top-Loading Washer

Read these instructions completely before beginning the routine cleaning processes recommended below. This Washer Maintenance Procedure should be performed, at a minimum, once per month or every 30 wash cycles, whichever occurs sooner, to control the rate at which soils and detergent may otherwise accumulate in your washer.

Cleaning the Inside of the Washer

To keep your washer odor-free, follow the usage instructions provided above and use this recommended monthly cleaning procedure:

Recommended Cycle for Cleaning the Washer

Refer to the "Cycle Guide" for the optimal cycle for cleaning the inside of the washer. Use this cycle with affresh® Washer Cleaner or liquid chlorine bleach as described below.

Begin procedure

Washer Cleaner Cycle Procedure (Recommended for Best Performance):

- a. Open the washer lid and remove any clothing or items.
- b. Use an affresh® Machine Cleaning Wipe or a soft, damp cloth or sponge to clean the inside of the door.
- c. Place an affresh® Washer Cleaner tablet in the bottom of the washer basket.
- d. Do not add any detergent or other chemical to the washer when following this procedure.
- e. Close the washer lid.
- f. Select the Clean Washer cycle.
- g. Press and hold START/PAUSE to begin the cycle.

NOTE: For best results, do not interrupt cycle. If cycle must be interrupted, press POWER ON/OFF. After the Clean Washer cycle has stopped, run a Rinse cycle to rinse cleaner from washer.

WASHER CARE (cont.)

Chlorine Bleach Procedure (Alternative):

- a. Open the washer lid and remove any clothing or items.
- b. Add 1 cup (236 mL) of liquid chlorine bleach to the bleach compartment.
NOTE: Use of more liquid chlorine bleach than is recommended above could cause washer damage over time.
- c. Close the washer lid.
- d. Do not add any detergent or other chemical to the washer when following this procedure.
- e. Select the Clean Washer cycle.
- f. Press and hold START/PAUSE to begin the cycle.
The Clean Washer Cycle Operation is described below.

NOTE: For best results, do not interrupt cycle. If cycle must be interrupted, press POWER ON/OFF. After the Clean Washer cycle has stopped, run a Rinse cycle to rinse cleaner from washer.

Description of Clean Washer Cycle Operation:

During this cycle, there will be some agitation and spinning to increase the removal of soils.

After the cycle is complete, leave the lid open to allow for better ventilation and drying of the washer interior.

Cleaning the Dispensers

After a period of using your washer, you may find some residue buildup in the washer's dispensers. To remove residue from the dispensers, wipe them with a damp cloth and towel dry. Do not attempt to remove the dispensers or trim for cleaning. The dispensers and trim are not removable. Use an all-purpose surface cleaner, if needed.

Cleaning the Outside of the Washer

Use an affresh® Machine Cleaning Wipe or a soft, damp cloth or sponge to wipe away any spills. Use only an affresh® Machine Cleaning Wipe or mild soaps or cleaners when cleaning external washer surfaces.

IMPORTANT: To avoid damaging the washer's finish, do not use abrasive products.

WASHER CARE (cont.)

Cleaning The Lint Filter

Clean filter after every load.

1. Press down, then out, to remove the lint filter.

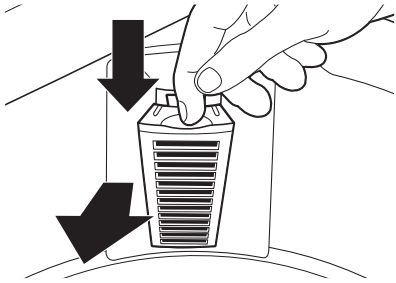

2. Open the lint filter, remove lint, and clean with water.

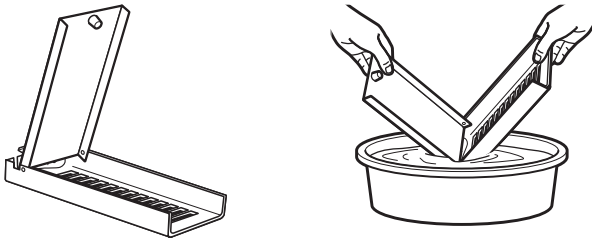

3. Insert the lint filter bottom first; then press down and in to replace the filter.

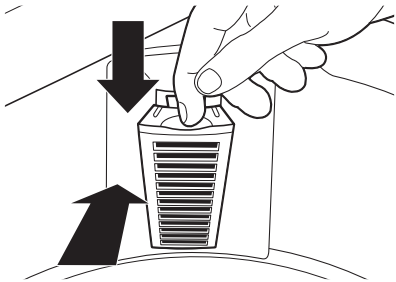

CLEANING THE WASHER/DRYER LOCATION

Keep washer/dryer area clear and free from items that would block the airflow for proper washer/dryer operation. This includes clearing piles of laundry in front of the washer/dryer.

⚠️ WARNING



Explosion Hazard

Keep flammable materials and vapors, such as gasoline, away from dryer.

Place dryer at least 18 inches (460 mm) above the floor for a garage installation.

Failure to do so can result in death, explosion, or fire.

CLEANING THE DRYER INTERIOR

To clean dryer drum:

1. Apply a liquid, nonflammable household cleaner to the stained area of the drum and rub with a soft cloth until stain is removed.
2. Wipe drum thoroughly with a damp cloth.
3. Tumble a load of clean cloths or towels to dry the drum.

NOTE: Garments that contain loose dyes, such as denim blue jeans or brightly colored cotton items, may discolor the dryer interior. These stains are not harmful to your dryer and will not stain future loads of clothes. Dry these items inside out to avoid drum staining.

REMOVING ACCUMULATED LINT

From Inside the Dryer Cabinet

Lint should be removed every 2 years, or more often, depending on dryer usage. Cleaning should be done by a qualified servicer.

From the Exhaust Vent

Lint should be removed every 2 years, or more often, depending on dryer usage.

CLEANING THE LINT SCREEN

Every load cleaning

A screen blocked by lint can increase drying time.

The lint screen is located inside the dryer on the back wall.

To clean:

1. Pull out the lint screen and its cover. Separate the cover and the screen by squeezing the screen and pulling on the cover at the same time. Roll lint off the screen with your fingers.

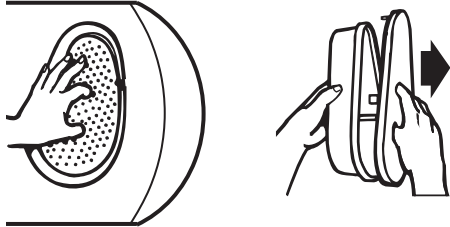

Do not rinse or wash the screen to remove lint. Wet lint is hard to remove.

2. Put the lint screen and its cover back together and push firmly back into place.

IMPORTANT:

- Do not run the dryer with the lint screen loose, damaged, blocked, or missing. Doing so can cause overheating and damage to both the dryer and fabrics.
- If lint falls off the screen into the dryer during removal, check the exhaust hood and remove the lint. See “Venting Requirements” in the Installation Instructions.

As needed cleaning

Laundry detergent and fabric softener residue can build up on the lint screen. This buildup can cause longer drying times for your clothes, or cause the dryer to stop before your load is completely dry. The screen is probably clogged if lint falls off while the screen is in the dryer.

Clean the lint screen with a nylon brush every 6 months, or more frequently, if it becomes clogged due to a residue buildup.

To wash:

1. Roll lint off the screen with your fingers.
2. Wet both sides of lint screen with hot water.
3. Wet a nylon brush with hot water and liquid detergent. Scrub lint screen with the brush to remove residue buildup.



4. Rinse screen with hot water.
5. Thoroughly dry lint screen with a clean towel. Reinstall screen in dryer.

CHANGING THE DRUM LIGHT (on some models)

1. Unplug dryer or disconnect power.
2. Open the dryer door. Locate the light bulb cover on the back wall of the dryer. Using a Phillips-head screwdriver, remove the screw located in the lower right-hand corner of the cover. Remove the cover.

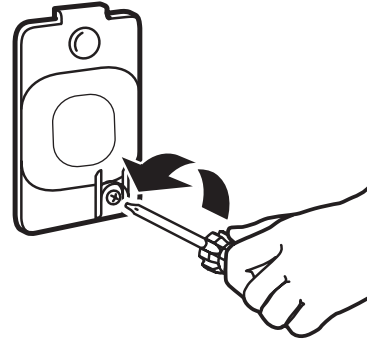

3. Turn bulb counterclockwise. Replace the bulb with a 10-watt appliance bulb only. Replace the cover and secure with the screw.
4. Plug into a grounded outlet or reconnect power.

VACATION, STORAGE, AND MOVING CARE

Non-Use or Storage Care

Operate your washer/dryer only when you are at home. If you will be on vacation or not using your washer/dryer for an extended period of time, you should:

1. Unplug washer/dryer or disconnect power.
2. Turn off water supply to washer, to avoid flooding due to water pressure surge.
3. For gas dryers only: Close shut-off valve to gas supply line.
4. Clean lint screen. See “Cleaning the Lint Screen”.

Moving Care

For power supply cord-connected washer/dryers:

1. Unplug the power supply cord.
2. Make sure leveling legs are secure in washer/dryer base.
3. Continue with “For washers/dryers” on next page.

⚠️ WARNING



Electrical Shock Hazard

Disconnect power before servicing.

Replace all parts and panels before operating.

Failure to do so can result in death or electrical shock.

REINSTALLING/USING WASHER/DRYER AGAIN

To reinstall washer/dryer after non-use, vacation, moving, or winter storage:

1. Refer to Installation Instructions to locate, level, and connect washer/dryer.
2. Before using again, run washer/dryer through the following recommended procedure:

To use washer/dryer again:

1. Flush water pipes and hoses. Reconnect water inlet hoses. Turn on both water faucets.

In the U.S.A.

⚠️ WARNING



Electrical Shock Hazard

Plug into a grounded 3 prong outlet.

Do not remove ground prong.

Do not use an adapter.

Do not use an extension cord.

Failure to follow these instructions can result in death, fire, or electrical shock.

In Canada

⚠️ WARNING



Electrical Shock Hazard

Plug into a grounded 4 prong outlet.

Failure to do so can result in death or electrical shock.

In the U.S.A. and Canada

2. Plug in washer/dryer or reconnect power.
3. Run washer through Heavy Duty cycle to clean washer and remove antifreeze, if used. Use only HE High Efficiency detergent. Use half the manufacturer's recommended amount of detergent for a medium-size load.

VACATION, STORAGE, AND MOVING CARE (cont.)

For washers/dryers:

1. Shut off both water faucets. Disconnect and drain water inlet hoses.
2. If washer/dryer will be moved during freezing weather, follow "Winter Storage Care" directions before moving.
3. Disconnect drain hose from drain system and drain any remaining water into a pan or bucket. Disconnect drain hose from back of washer.
4. Place inlet hoses and drain hose inside washer basket.
5. Drape power cord over edge and into washer basket.
6. Place packing tray from original shipping materials back inside washer/dryer. If you do not have packing tray, place heavy blankets or towels into basket opening. Close lids/doors and place tape over lids/doors and down front of washer/dryer. Keep lids/doors taped until washer/dryer is placed in new location.

WINTER STORAGE CARE

IMPORTANT: To avoid damage, install and store washer/dryer where it will not freeze. Because some water may stay in hoses, freezing can damage washer/dryer. If storing or moving during freezing weather, winterize your washer/dryer.

To winterize washer/dryer:

1. Shut off both water faucets, disconnect and drain water inlet hoses.
2. Put 1 qt. (1 L) of R.V.-type antifreeze in basket and run washer on Normal cycle for about 2 minutes to mix antifreeze and remaining water.
3. Unplug washer/dryer or disconnect power.

TROUBLESHOOTING – WASHER

First try the solutions suggested here or visit our website at www.whirlpool.com/product_help –
In Canada www.whirlpool.ca for assistance and to possibly avoid a service call.

If you experience	Possible Causes	Solution
Vibration or Off-Balance		
Vibration, rocking, or “walking”	Feet may not be in contact with the floor and locked.	Front and rear feet or casters must be in firm contact with floor, and washer/dryer must be level to operate properly.
	Washer may not be level.	Check floor for flexing or sagging. If flooring is uneven, a 3/4" (19 mm) piece of plywood under your washer will reduce sound. See “Level the Washer/Dryer” in the Installation Instructions.
Vibration during spinning or washer stopped	Load could be unbalanced.	Load items in loose heaps evenly around the washplate. Adding wet items to washer or adding more water to basket could unbalance washer.
		Avoid washing single items. Balance a single item such as a rug or jeans jacket with a few extra items. Redistribute the load, close the lid, and press START/PAUSE.
		Item or load not suitable for selected cycle. See “Cycle Guide” and “Using Your Washer.”
Noises		
Clicking or metallic noises	Objects may be caught in washer drain system.	Empty pockets before washing. Loose items such as coins could fall between basket and tub or may block pump. It may be necessary to call for service to remove items.
		It is normal to hear metal items on clothing such as metal snaps, buckles, or zippers touch against the stainless steel basket.
Gurgling or humming	Washer may be draining water.	It is normal to hear the pump making a continuous humming sound with periodic gurgling or surging as final amounts of water are removed during the spin/drain cycles.
Humming	Load sensing may be occurring.	You may hear the hum of the sensing spins after you have started the washer. This is normal.
Whirring	Basket may be slowing down.	You may hear the whirring sound of the basket slowing down. This is normal.
Water Leaks		
Check the following for proper installation:	Washer not level.	Water may splash off basket if washer is not level.
	Fill hoses not attached tightly.	Tighten fill-hose connection.
	Fill hose washers	Make sure fill hose flat washers are properly seated.
	Drain hose connection	Properly secure drain hose to drainpipe or laundry tub.
		Do not place tape over drain opening.
	Check household plumbing for leaks or clogged sink or drain.	Water can back up out of a clogged sink or drainpipe. Check all household plumbing for leaks (laundry tubs, drain pipe, water pipes, and faucets.)
Washer not loaded as recommended.	An unbalanced load can cause basket to be out of alignment and cause water to splash off tub. See “Using Your Washer” for loading instructions.	
Washer not performing as expected		
Not enough water in washer	Load not completely covered in water.	This is normal operation for an HE low-water washer. The load will not be completely underwater. The washer senses load sizes and adds correct amount of water for optimal cleaning. IMPORTANT: Do not add more water to washer. Adding water lifts the items off the washplate, resulting in less effective cleaning.
		Run Clean Washer cycle to optimize the water level and wash performance.

TROUBLESHOOTING – WASHER (CONT.)

First try the solutions suggested here or visit our website at www.whirlpool.com/product_help –
In Canada www.whirlpool.ca for assistance and to possibly avoid a service call.

If you experience	Possible Causes	Solution
Washer not performing as expected (cont.)		
Washer won't run or fill; washer stops working	Check for proper water supply.	Hose(s) must be attached and have water flowing to inlet valve.
		Water faucet(s) must be turned on.
		Check that inlet valve screens have not become clogged.
		Check for any kinks in inlet hoses, which can restrict water flow.

⚠ WARNING



Electrical Shock Hazard

Plug into a grounded 3 prong outlet.

Do not remove ground prong.

Do not use an adapter.

Do not use an extension cord.

Failure to follow these instructions can result in death, fire, or electrical shock.

Washer won't run or fill; washer stops working (cont.)	Check proper electrical supply.	Plug power cord into a grounded 3 prong outlet.
		Do not use an extension cord.
		Ensure there is power to outlet.
		Reset a tripped circuit breaker. Replace any blown fuses. NOTE: If problems continue, contact an electrician.
	Normal washer operation.	Lid must be closed for washer to run.
		Washer will pause during certain phases of cycle. Do not interrupt cycle.
		Washer may be stopped to reduce suds.
	Washer may be tightly packed.	Remove several items, rearrange load evenly around the washplate. Close lid, press START/PAUSE button.
Add only one or two additional items after washer has started.		
Do not add more water to the washer.		
Not using HE detergent or using too much HE detergent.	Only use HE detergent. Suds from regular detergents can slow or stop the washer. Always measure detergent and follow detergent directions based on your load requirements.	
	To remove suds, cancel cycle. Select Rinse then Spin. Do not add more detergent.	
Washer not draining/ spinning; loads are still wet	Small items may have been caught in pump or between basket and tub, which can slow draining.	Empty pockets and use garment bags for small items.
	Using cycles with a lower spin speed.	Cycles with lower spin speeds remove less water than cycles with high spin speeds. Use the recommended cycle/speed spin for your item.
	Washer may be tightly packed or unbalanced.	Tightly packed loads may not allow the washer to spin correctly, leaving the load wetter than normal. Evenly arrange the wet load for balanced spinning. Select SPIN to remove excess water. See "Using Your Washer" for loading recommendations.

TROUBLESHOOTING – WASHER (CONT.)

First try the solutions suggested here or visit our website at www.whirlpool.com/product_help –
In Canada www.whirlpool.ca for assistance and to possibly avoid a service call.

If you experience	Possible Causes	Solution
Washer not performing as expected (cont.)		
Washer not draining/ spinning; loads are still wet (cont.)	Load unbalanced.	See “Vibration or Off-Balance” in “Troubleshooting” section for more information.
	Check plumbing for correct drain hose installation. Drain hose extends into standpipe farther than 4.5" (114 mm).	Check drain hose for proper installation. Use drain hose form and securely attach to drainpipe or tub. Do not tape over drain opening. Lower drain hose if the end is higher than 96" (2.4 m) above the floor. Remove any clogs from drain hose.
	Not using HE detergent or using too much HE detergent.	Suds from regular detergent or using too much detergent can slow or stop draining or spinning. Use only HE detergent. Always measure and follow detergent directions for your load. To remove extra suds, select RINSE. Do not add detergent.
Incorrect or wrong wash or rinse temperatures	Check for proper water supply.	Make sure that hot and cold inlet hoses are not reversed.
		Both hoses must be attached to both washer and faucet, and have both hot and cold water flowing to inlet valve.
		Check that inlet valve screens are not clogged.
		Remove any kinks in hoses.
Load not rinsed	Check for proper water supply.	Make sure hot and cold inlet hoses are not reversed.
		Hoses must be attached and have water flowing to the inlet valves or faucet.
		Both hot and cold water faucets must be on.
		Inlet valve screens on washer may be clogged.
		Remove any kinks in the inlet hose.
	Not using HE detergent or using too much HE detergent.	The suds from regular detergent can cause the washer to operate incorrectly.
		Use only HE detergent. Be sure to measure correctly.
		Always measure detergent and follow detergent directions based on load size and soil level.
	Washer may be tightly packed.	The washer is less efficient at rinsing when load is tightly packed.
		Load items in loose heaps evenly around the washplate.
Use cycle designed for the fabrics being washed.		
Add only one or two additional items after washer has started.		
Sand, pet hair, lint, etc. on load after washing	Heavy sand, pet hair, lint, and detergent or bleach residues may require additional rinsing.	Run an additional Rinse cycle.
Load is tangling	Washer not loaded as recommended.	Load items in loose heaps evenly around the washplate. Reduce tangling by mixing types of load items. Use the recommended cycle for the type of items being washed.
	Wash action and/or spin speed too fast for load.	Select a cycle with a slower wash action and slower spin speed. Note that items will be wetter than when using a higher speed spin.
Not cleaning or removing stains	Wash load not completely covered in water.	Washer senses load size and adds correct amount of water. This is normal and necessary for clothes to move.
	Added more water to washer.	Do not add more water to washer. Adding water lifts the items off the washplate, resulting in less effective cleaning.
	Washer not loaded as recommended.	Load items in loose heaps evenly around the washplate. Add only one or two additional items after washer has started.

TROUBLESHOOTING – WASHER (CONT.)

First try the solutions suggested here or visit our website at www.whirlpool.com/product_help –
In Canada www.whirlpool.ca for assistance and to possibly avoid a service call.

If you experience	Possible Causes	Solution
Washer not performing as expected (cont.)		
Not cleaning or removing stains (cont.)	Not using HE detergent or using too much HE detergent.	The suds from regular detergent can keep washer from operating correctly.
		Use only HE detergent. Be sure to measure correctly.
		Always measure detergent and follow detergent directions based on load size and soil level.
	Not using correct cycle for fabric type.	Use a higher soil level cycle option and warmer wash temperature to improve cleaning.
		Use Heavy Duty cycle for tough cleaning.
		See the “Cycle Guide” to match your load with the best cycle.
	Not using dispensers.	Use dispensers to avoid chlorine bleach and fabric softener staining.
		Load dispensers before starting a cycle.
		Avoid overfilling.
		Do not add products directly onto load.
Not washing like colors together.	Wash like colors together and remove promptly after the cycle is complete to avoid dye transfer.	
Odors	Monthly maintenance not done as recommended.	Run the Clean Washer cycle after every 30 washes. See “Washer Care.”
		Unload washer as soon as cycle is complete.
	Not using HE detergent or using too much HE detergent.	Use only HE detergent. Be sure to measure correctly.
		Always follow the detergent directions.
		See “Washer Care” section.
Fabric damage	Sharp items were in pockets during wash cycle.	Empty pockets, zip zippers, and snap or hook fasteners before washing to avoid snags and tears.
	Strings and straps could have tangled.	Tie all strings and straps before starting wash load.
	Items may have been damaged before washing.	Mend rips and broken threads in seams before washing.
	Fabric damage can occur if the load is tightly packed.	Load items in loose heaps evenly around washplate.
		Load items should move freely during wash cycle to avoid damage.
		Use cycle designed for the fabrics being washed.
		Add only one or two additional items after washer has started.
	Garment care instructions may not have been followed.	Always read and follow garment manufacturer’s care label instructions. See the “Cycle Guide” to match your load with the best cycle.
	Liquid chlorine bleach may have been added incorrectly.	Do not pour liquid chlorine bleach directly onto load. Wipe up bleach spills.
		Undiluted bleach will damage fabrics. Do not use more than recommended by manufacturer.
Do not place load items on top of bleach dispenser when loading and unloading washer.		



TROUBLESHOOTING – WASHER (CONT.)

First try the solutions suggested here or visit our website at www.whirlpool.com/product_help –
In Canada www.whirlpool.ca for assistance and to possibly avoid a service call.

If you experience	Possible Causes	Solution
Washer not performing as expected (cont.)		
Incorrect dispenser operation	Clogged dispensers or laundry products dispensing too soon.	Do not overfill dispenser. Overfilling causes immediate dispensing.
		Load dispensers before starting a cycle.
		It is normal for small amounts of water to be remain in dispenser at the end of the cycle.
		Fabric softener thickens as it gets older. If there becomes an increase of fabric softener in the dispenser after a cycle, check the age of the fabric softener and replace if needed.
	Liquid chlorine bleach or fabric softener not used in dispensers.	Use only liquid chlorine bleach in the bleach dispenser. Use only fabric softener in the fabric softener dispenser.
Powdered detergent not dissolving completely in load	Using too much HE detergent.	Follow the manufacturer's instructions to determine the amount of detergent to use.
	Water temperature is very cold.	Select a warmer wash temperature.
Single-dose laundry packet not dissolving	Adding laundry packet incorrectly.	Be sure laundry packet is added to washer basket before adding clothes. Follow the manufacturer's instructions to avoid damage to your items.
Error Code Appears in Display		
E1 – Water inlet alarm	Water level not reached after 20 minutes.	Check that the water faucets are not closed.
		Check that the water pressure in the house is over 20 kPa.
		Clean the inlet hose filter screens.
		Check that the drain hose is not below 27½" (700 mm) from the floor.
E2 – Draining alarm	Washer is still detecting water after draining for 8 minutes.	Check that the drain hose is not more than 39⅓" (100 cm) from the floor.
		Remove any clogs from the drain hose.
E3 – Unbalanced alarm	Washer may be tightly packed or clothes are not evenly distributed.	Remove several items, rearrange load evenly around the washplate, and restart the Spin cycle.
E4 – Open lid alarm	Opening the lid during the Spin cycle.	Close the lid.
E5, EA, EC, EL, or EP – Other errors	Other	Call for technical assistance – see “Assistance or Service” on the back cover.

TROUBLESHOOTING – DRYER

First try the solutions suggested here or visit our website at www.whirlpool.com/product_help –
In Canada www.whirlpool.ca for assistance and to possibly avoid a service call.

If you experience	Possible Causes	Solution
Dryer not performing as expected		
Clothes are not drying satisfactorily, drying times are too long	Lint screen clogged with lint.	Lint screen should be cleaned before each load.
	The Air Only cycle has been selected.	Select the correct cycle for the types of garments being dried. See “Dryer Cycle Guide.”
	Load too large and heavy to dry quickly.	Separate the load to tumble freely.
	Exhaust vent or outside exhaust hood clogged with lint, restricting air movement.	Run the dryer for 5–10 minutes. Hold your hand under the outside exhaust hood to check air movement. If you do not feel air movement, clean exhaust system of lint or replace exhaust vent with heavy metal or flexible metal vent. Make sure vent is not crushed or kinked. See Installation Instructions.
	Fabric softener sheets blocking the grille.	Use only one fabric softener sheet, and use it only once.
	Exhaust vent not the correct length.	Check that the exhaust vent is not too long or has too many turns. Long venting will increase drying times. Make sure vent is not crushed or kinked. See Installation Instructions.
	Exhaust vent diameter not the correct size.	Use 4" (102 mm) diameter vent material.
	Dryer located in a room with temperature below 45°F (7°C).	Proper operation of dryer cycles requires temperatures above 45°F (7°C).
	Dryer located in a closet without adequate opening.	Closet doors must have ventilation openings at the top and bottom of the door. The front of the dryer requires a minimum of 1" (25 mm) of airspace, and, for most installations, the rear of the dryer requires 5" (127 mm). See Installation Instructions.
Dryer will not run	Door not closed completely.	Make sure the dryer door is closed completely.
	Start button not pressed firmly or held long enough.	Press and hold the START button until you hear the dryer drum moving.
	Household fuse is blown or circuit breaker has tripped.	240V models: Electric dryers use two household fuses or circuit breakers. The drum may be turning, but you may not have heat. Replace both fuses or reset the circuit breaker. If the problem continues, call an electrician.
	Incorrect power supply.	240V models: Electric dryers require 240-volt power supply. Check with a qualified electrician.
	Wrong type of fuse.	Use a time-delay fuse.
Unusual sounds	Dryer had a period of non-use.	If the dryer hasn't been used for a while, there may be a thumping sound during the first few minutes of operation.
	A coin, button, or paper clip is caught between the drum and front or rear of the dryer.	Check the front and rear edges of the drum for small objects. Clean out pockets before laundering.
	It is a gas dryer.	The gas valve clicking is a normal operating sound.
	The dryer is not level front to back and side to side.	The dryer may vibrate if not properly installed. See Installation Instructions.
	Clothing knotted or balled up.	When balled up, the load will bounce, causing the dryer to vibrate. Separate the load items and restart the dryer.

TROUBLESHOOTING – DRYER (CONT.)

First try the solutions suggested here or visit our website at www.whirlpool.com/product_help –
In Canada www.whirlpool.ca for assistance and to possibly avoid a service call.

If you experience	Possible Causes	Solution
Dryer not performing as expected (cont.)		
No heat	Household fuse is blown or circuit breaker has tripped.	240V models: The drum may be turning, but you may not have heat. Electric dryers use two household fuses or circuit breakers. Replace both fuses or reset the circuit breaker. If the problem continues, call an electrician.
	Incorrect power supply.	240V models: Electric dryers require 240-volt power supply. Check with a qualified electrician.
Cycle time too short	Automatic cycle ending early.	120V models: The load may not be contacting the sensor strips. Level the dryer.
		Use Timed Drying for very small loads. Change the Dryness Level setting on the Normal and Delicate cycles. Increasing or decreasing the Dryness Level setting will change the amount of drying time in a cycle.
Lint on load	Lint screen clogged.	Lint screen should be cleaned before each load.
Stains on load or drum	Dryer fabric softener not properly used.	Add dryer fabric softener sheets at the beginning of the cycle. Fabric softener sheets added to a partially dried load can stain your garments.
		Drum stains are caused by dyes in clothing (usually blue jeans). These will not transfer to other clothing.
Loads are wrinkled	Load not removed from dryer at the end of the cycle.	Run the Air Only cycle to tumble the load without heat to avoid wrinkling.
	Dryer tightly packed.	Dry smaller loads that can tumble freely to reduce the chance of wrinkles forming.
Odors	You have recently been painting, staining, or varnishing in the area where your dryer is located.	Ventilate the area. When the odors or fumes are gone from the area, rewash and dry the clothing.
	The dryer is being used for the first time.	The new electric heating element may have an odor. The odor will be gone after the first cycle.
Load is too hot	Laundry items were removed from the dryer before the end of the cycle.	All cycles are cooled slowly to reduced wrinkling and make it easier to handle. Items removed before the cool down may feel very warm.
	A high temperature cycle was used.	Select a lower temperature, and use an automatic drying cycle. These cycles sense the temperature or the moisture level in the load and shut off when the load reaches the selected dryness. This reduces overdrying.

WHIRLPOOL® LAUNDRY LIMITED WARRANTY

ATTACH YOUR RECEIPT HERE. PROOF OF PURCHASE IS REQUIRED TO OBTAIN WARRANTY SERVICE.

Please have the following information available when you call the Customer eXperience Center:

- Name, address, and telephone number
- Model number and serial number
- A clear, detailed description of the problem
- Proof of purchase, including dealer or retailer name and address

IF YOU NEED SERVICE:

1. Before contacting us to arrange service, please determine whether your product requires repair. Some questions can be addressed without service. Please take a few minutes to review the Troubleshooting section of the Use and Care Guide or visit producthelp.whirlpool.com.
2. All warranty service is provided exclusively by our authorized Whirlpool Service Providers. In the U.S. and Canada, direct all requests for warranty service to:

Whirlpool Customer eXperience Center

In the U.S.A., call 1-800-253-1301. In Canada, call 1-800-807-6777.

If outside the 50 United States or Canada, contact your authorized Whirlpool dealer to determine whether another warranty applies.

ONE YEAR LIMITED WARRANTY

WHAT IS COVERED

For one year from the date of purchase, when this major appliance is installed, operated, and maintained according to instructions attached to or furnished with the product, Whirlpool Corporation or Whirlpool Canada LP (hereafter "Whirlpool") will pay for factory specified replacement parts and repair labor to correct defects in materials or workmanship that existed when this major appliance was purchased or, at its sole discretion, replace the product. In the event of product replacement, your appliance will be warranted for the remaining term of the original unit's warranty period.

YOUR SOLE AND EXCLUSIVE REMEDY UNDER THIS LIMITED WARRANTY SHALL BE PRODUCT REPAIR AS PROVIDED HEREIN. Service must be provided by a Whirlpool designated service company. This limited warranty is valid only in the United States or Canada and applies only when the major appliance is used in the country in which it was purchased. This limited warranty is effective from the date of original consumer purchase. Proof of original purchase date is required to obtain service under this limited warranty.

WHAT IS NOT COVERED

1. Commercial, non-residential, multiple-family use, or use inconsistent with published user, operator, or installation instructions.
2. In-home instruction on how to use your product.
3. Service to correct improper product maintenance or installation, installation not in accordance with electrical or plumbing codes, or correction of household electrical or plumbing (e.g., house wiring, fuses, or water inlet hoses).
4. Consumable parts (e.g., light bulbs, batteries, air or water filters, preservation solutions).
5. Defects or damage caused by the use of non-genuine Whirlpool parts or accessories.
6. Conversion of products from natural gas or propane gas, or reversal of appliance doors.
7. Damage from accident, misuse, abuse, fire, floods, acts of God, or use with products not approved by Whirlpool.
8. Repairs to parts or systems to correct product damage or defects caused by unauthorized service, alteration, or modification of the appliance.
9. Cosmetic damage including scratches, dents, chips, and other damage to the appliance finishes, unless such damage results from defects in materials and workmanship and is reported to Whirlpool within 30 days.
10. Discoloration, rust, or oxidation of surfaces resulting from caustic or corrosive environments including, but not limited to, high salt concentrations, high moisture or humidity, or exposure to chemicals.
11. Pickup or delivery. This product is intended for in-home repair.
12. Travel or transportation expenses for service in remote locations where an authorized Whirlpool servicer is not available.
13. Removal or reinstallation of inaccessible appliances or built-in fixtures (e.g., trim, decorative panels, flooring, cabinetry, islands, countertops, drywall) that interfere with servicing, removal, or replacement of the product.
14. Service or parts for appliances with original model/serial numbers removed, altered, or not easily determined.

The cost of repair or replacement under these excluded circumstances shall be borne by the customer.

DISCLAIMER OF IMPLIED WARRANTIES

IMPLIED WARRANTIES, INCLUDING ANY IMPLIED WARRANTY OF MERCHANTABILITY OR IMPLIED WARRANTY OF FITNESS FOR A PARTICULAR PURPOSE, ARE LIMITED TO ONE YEAR OR THE SHORTEST PERIOD ALLOWED BY LAW. Some states and provinces do not allow limitations on the duration of implied warranties of merchantability or fitness, so this limitation may not apply to you. This warranty gives you specific legal rights, and you also may have other rights that vary from state to state or province to province.

DISCLAIMER OF REPRESENTATIONS OUTSIDE OF WARRANTY

Whirlpool makes no representations about the quality, durability, or need for service or repair of this major appliance other than the representations contained in this warranty. If you want a longer or more comprehensive warranty than the limited warranty that comes with this major appliance, you should ask Whirlpool or your retailer about buying an extended warranty.

LIMITATION OF REMEDIES: EXCLUSION OF INCIDENTAL AND CONSEQUENTIAL DAMAGES

YOUR SOLE AND EXCLUSIVE REMEDY UNDER THIS LIMITED WARRANTY SHALL BE PRODUCT REPAIR AS PROVIDED HEREIN. WHIRLPOOL SHALL NOT BE LIABLE FOR INCIDENTAL OR CONSEQUENTIAL DAMAGES. Some states and provinces do not allow the exclusion or limitation of incidental or consequential damages, so these limitations and exclusions may not apply to you. This warranty gives you specific legal rights, and you also may have other rights that vary from state to state or province to province.

06/17

Assistance or Service

Before calling for assistance or service, please check "Troubleshooting" or visit www.whirlpool.com/help. It may save you the cost of a service call. If you still need help, follow the instructions below. When calling, please know the purchase date and the complete model and serial number of your appliance. This information will help us to better respond to your request.

If you need replacement parts or to order accessories

We recommend that you use only FSP® Factory Specified Parts. These parts will fit right and work right because they are made with the same precision used to build every new WHIRLPOOL® appliance.

To locate FSP® replacement parts or accessories go to www.whirlpoolparts.com.

Questions? Call us toll free at 1-866-698-2538 or in Canada call 1-800-688-2002.

Our consultants provide assistance with

In the U.S.A.

- Features and specifications on our full line of appliances.
- Installation information.
- Specialized customer assistance (Spanish speaking, hearing impaired, limited vision, etc.).

In the U.S.A. and Canada

- Use and maintenance procedures.
- Accessory and repair parts sales.
- Referrals to local dealers, repair parts distributors, and service companies. Whirlpool designated service technicians are trained to fulfill the product warranty and provide after-warranty service, anywhere in the United States and Canada.

You can write with any questions or concerns at:

Whirlpool Brand Appliances
Customer eXperience Center
553 Benson Road
Benton Harbor, MI 49022-2692
1-866-698-2538

Whirlpool Brand Appliances
Customer eXperience Centre
Unit 200-6750 Century Ave
Mississauga, Ontario L5N 0B7
1-800-688-2002

Please include a daytime phone number in your correspondence.

Assistance ou Service

Avant de faire un appel pour obtenir de l'assistance ou un entretien, vérifiez la section "Dépannage" ou consulter www.whirlpool.com/help. Cette vérification peut vous faire économiser le coût d'une visite de réparation.

Si vous avez encore besoin d'aide, suivre les instructions ci-dessous.

Lors d'un appel, garder à portée de main la date d'achat et les numéros de modèle et de série de votre appareil. Ces renseignements nous aideront à mieux répondre à votre demande.

Pour commander des pièces de rechange ou des accessoires

Pour commander des pièces de rechange, nous vous recommandons d'utiliser seulement des pièces spécifiées par l'usine. Ces pièces conviendront et fonctionneront bien parce qu'elles sont fabriquées selon les mêmes spécifications précises utilisées pour construire chaque nouvel appareil WHIRLPOOL®.

Pour trouver des pièces de rechange FSP® ou des accessoires, visiter le www.whirlpool.ca.

Des questions? Composer le numéro sans frais 1-800-688-2002.

Nos consultants fournissent l'assistance pour :

- Procédés d'utilisation et d'entretien.
- Vente d'accessoires et de pièces de rechange.
- Références aux concessionnaires, compagnies de service de réparation et distributeurs de pièces de rechange locaux. Les techniciens de service désignés par Whirlpool sont formés pour remplir la garantie des produits et fournir un service après la garantie, partout au Canada.

Pour plus d'assistance

Vous pouvez nous soumettre toute question ou toute problème en écrivant à l'adresse ci-dessous :

Whirlpool Brand Appliances
Centre pour l'eXpérience de la clientèle
Unit 200-6750 Century Ave
Mississauga, Ontario L5N 0B7
1-800-688-2002

Dans votre correspondance, veuillez indiquer un numéro de téléphone où nous pouvons vous joindre dans la journée.

