

VEVOR[®]

TOUGH TOOLS, HALF PRICE

Technical Support and E-Warranty Certificate

www.vevor.com/support

PEGBBOARD USER MANUAL

**MODEL:SKU1-PEGBBOARD KIT & SKU2-PEGBBOARD KIT &
SKU3-PEGBBOARD KIT & SKU4-PEGBBOARD KIT &
SKU5-PEGBBOARD KIT & SKU6-PEGBBOARD KIT**

We continue to be committed to provide you tools with competitive price.

"Save Half", "Half Price" or any other similar expressions used by us only represents an estimate of savings you might benefit from buying certain tools with us compared to the major top brands and does not necessarily mean to cover all categories of tools offered by us. You are kindly reminded to verify carefully when you are placing an order with us if you are actually saving half in comparison with the top major brands.

VEVOR®

TOUGH TOOLS, HALF PRICE

PEGBOARD

MODEL:SKU1-PEGBOARD KIT & SKU2-PEGBOARD KIT & SKU3-PEGBOARD KIT &
SKU4-PEGBOARD KIT & SKU5-PEGBOARD KIT & SKU6-PEGBOARD KIT

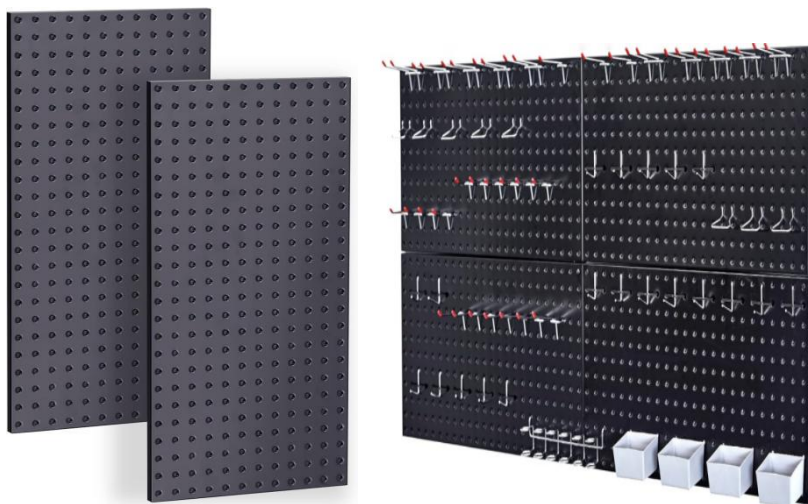

NEED HELP? CONTACT US!

Have product questions? Need technical support? Please feel free to contact us:

Technical Support and E-Warranty Certificate
www.vevor.com/support

This is the original instruction, please read all manual instructions carefully before operating. VEVOR reserves a clear interpretation of our user manual. The appearance of the product shall be subject to the product you received. Please forgive us that we won't inform you again if there are any technology or software updates on our product.

SAFETY INSTRUCTIONS



WARNING:

1. Read this material before using this product. Failure to do so can result in serious injury.
2. Do not exceed working capacity for pallet fork.
3. After use, please dry before storage to avoid rusting of product.
4. Procedures not specifically explained in this manual must be performed only by a qualified technician.

To prevent serious injury from tool failure, do not use it when it is damaged:

The pegboard must be mounted on a solid wall.

The pegboards shall not be installed on too thin wooden walls.

The pegboards shall not be installed on rotten or loose wooden walls.

The weight of the items to be hung shall not exceed the load of the pegboard.

When replacing the hook, it must be selected to match the size of the pegboard.

Avoid sharp points, blades, and other items that scratch the product



CAUTION:

Carefully read instructions and procedures for safe operations.

Save This Manual

MODEL AND PARAMETERS

Model SPEC.	SKU1- PEGBOARD KIT	SKU2- PEGBOARD KIT	SKU3- PEGBOARD KIT
Material	Steel	Steel	Steel
Max.Weight Capacity(single pegboard)	44lbs	44lbs	44lbs
Pegboard Size(L*W)	24x12inch	24x12inch	24x12inch
Hole Spec.	6mm	6mm	6mm
Number	2 pcs	3 pcs	4 pcs
Color	black	black	black
Model SPEC.	SKU4- PEGBOARD KIT	SKU5- PEGBOARD KIT	SKU6- PEGBOARD KIT
Material	Steel	Steel	Steel
Max.Weight Capacity(single pegboard)	44lbs	44lbs	44lbs
Pegboard Size(L*W)	32x16inch	24x12inch	24x12inch
Hole Spec.	6mm	6mm	6mm
Number	2 pcs	2 pcs	4 pcs
Color	black	black	black

COMPONENTS

Model Parts	SKU1-PEGB OARD KIT	SKU2-PEGB OARD KIT	SKU3-PEGB OARD KIT	SKU4-PEGB OARD KIT
Pegboard	×2	×3	×4	×2
Expansion Plug	×8	×12	×16	×8
Self-tapping Screw	×8	×12	×16	×8
User's Manual	×1	×1	×1	×1
Model Parts	SKU5-PEGB OARD KIT	SKU6-PEGB OARD KIT		
Pegboard	×2	×4		
Expansion Plug	×8	×16		
Self-tapping Screw	×8	×16		
User's Manual	×1	×1		
4inch Hook	×10	×10		
L Hook	×10	×10		
V Hook	×12	×12		
Pliers Holder	×8	×8		
Bolt Lock	×30	×30		
2inch Hook	/	×10		
Double Hook	/	×10		
6 Ring Work Frame	/	×1		
Work Bin	/	×4		



Expansion Plug



Self-tapping Screw



Double Hook



4inch Hook



2inch Hook



V Hook



L Hook



Pliers Holder



Bolt Lock

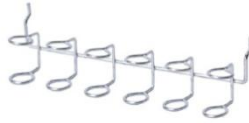

6 Ring Work Frame



Work Bin

INSTALLATION INSTRUCTION

Installation Preparation:

1. Two or more people to assemble the pegboard.
2. Please prepare a carpet or mat to protect your floor. You need to spread out all the accessories.
3. Please prepare gloves to avoid being scratched by sharp parts that may occur during installation.
4. Please open all the boxes to check if the accessories are complete and in good condition.
5. If you need to use power tools to install this product, please set the speed to low speed in advance.
6. When installing, please align all the holes and do not tighten all the screws first. Otherwise, it may make the installation difficult.

Installation Procedure:

STEP 1: Place the hanging board near the installed wall and mark the holes with a fine nail or pencil. (Note: Two holes on the left, two holes on the right)

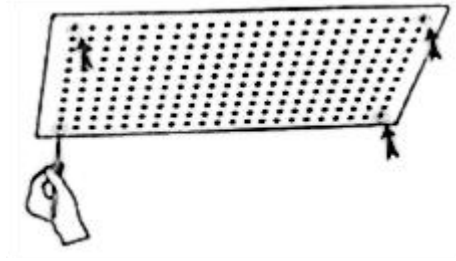

STEP 2:

For Concrete Wall Installation & Mounting Block + Concrete Wall Installation:

Drill holes 8mm in diameter and 40mm in depth at the marked places, nail the four expansion plugs completely into the hole.

(Note: Prepare your own drilling tools.)

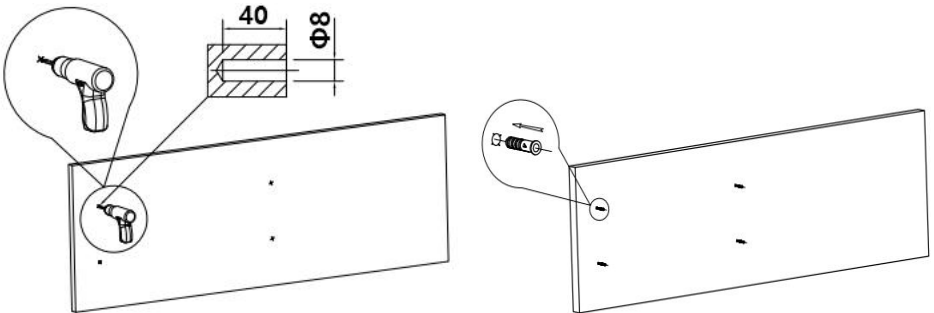

For Wooden Wall Post Installation:

Drill holes 3mm in diameter and 40mm in depth at the marked places. (Note: Prepare your own drilling tools.)

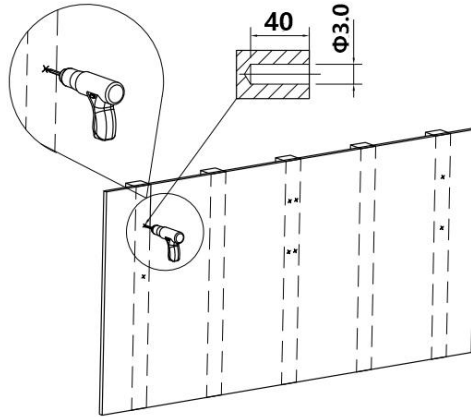

STEP 3: With the help of a screwdriver, fasten the pegboard with the screws to the wall.

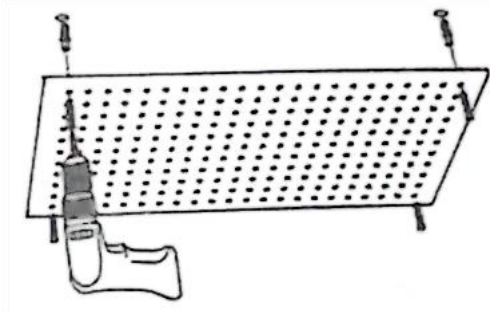

STEP 4: Follow the steps above to install other pegboards.
(Note: The pegboard is placed horizontally and vertically, and the installation method is the same.)

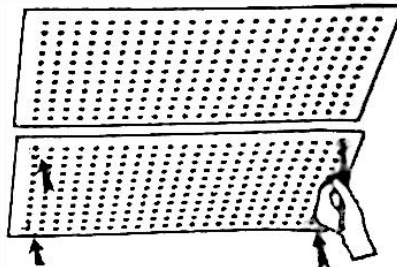

STEP 5: Install other accessories.

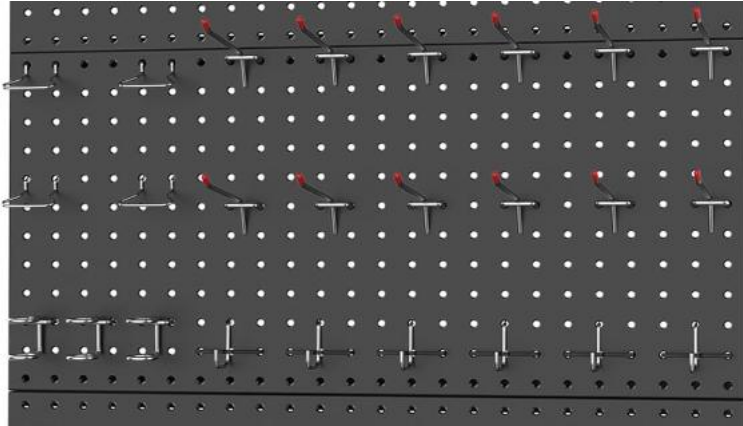

MAINTENANCE

- Do not exceed the weight capacity.
- After use, please clean and dry the product in a dry ventilated place.

Manufacturer: Shanghaimuxinmuyeyouxiangongsi

Address: Shuangchenglu 803nong11hao1602A-1609shi, baoshanqu, shanghai 200000 CN.

Imported to AUS: SIHAO PTY LTD. 1 ROKEVA STREET EASTWOOD NSW 2122 Australia

Imported to USA: Sanven Technology Ltd. Suite 250, 9166 Anaheim Place, Rancho Cucamonga, CA 91730

EC	REP
----	-----

E-CrossStu GmbH
Mainzer Landstr.69, 60329 Frankfurt am Main.

UK	REP
----	-----

YH CONSULTING LIMITED.
C/O YH Consulting Limited Office 147, Centurion House,
London Road, Staines-upon-Thames, Surrey, TW18 4AX

VEVOR[®]

TOUGH TOOLS, HALF PRICE

Technical Support and E-Warranty Certificate
www.vevor.com/support

VEVOR[®]

TOUGH TOOLS, HALF PRICE

Technique Certificat d'assistance et de garantie électronique

www.vevor.com/support

PANNEAU PERFORÉ MANUEL D'UTILISATION

**MODÈLE : SKU1-PEGBOARD KIT & SKU2-PEGBOARD KIT &
KIT DE PANNEAU PERFORÉ SKU3 ET KIT DE PANNEAU PERFORÉ SKU4 ET
KIT DE PANNEAU PERFORÉ SKU5 ET KIT DE PANNEAU PERFORÉ SKU6**

We continue to be committed to provide you tools with competitive price.

"Save Half", "Half Price" or any other similar expressions used by us only represents an estimate of savings you might benefit from buying certain tools with us compared to the major top brands and does not necessarily mean to cover all categories of tools offered by us. You are kindly reminded to verify carefully when you are placing an order with us if you are actually saving half in comparison with the top major brands.

VEVOR®

TOUGH TOOLS, HALF PRICE

PEGBOARD

MODÈLE : SKU1-PEGBOARD KIT & SKU2-PEGBOARD KIT & SKU3-PEGBOARD KIT
& SKU4-PEGBOARD KIT & SKU5-PEGBOARD KIT & SKU6-PEGBOARD KIT

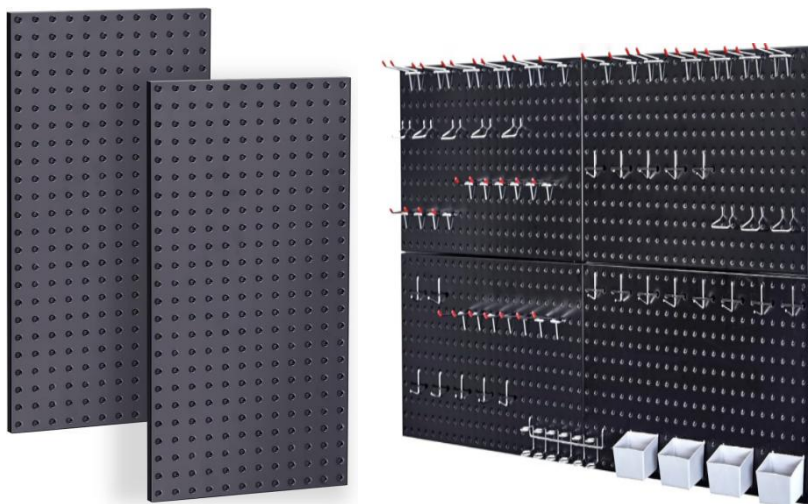

NEED HELP? CONTACT US!

Have product questions? Need technical support? Please feel free to contact us:

Technical Support and E-Warranty Certificate
www.vevor.com/support

This is the original instruction, please read all manual instructions carefully before operating. VEVOR reserves a clear interpretation of our user manual. The appearance of the product shall be subject to the product you received. Please forgive us that we won't inform you again if there are any technology or software updates on our product.

SAFETY INSTRUCTIONS



AVERTISSEMENT:

1. Lisez attentivement ce document avant d'utiliser ce produit. Le non-respect de ces instructions peut entraîner des blessures graves.
2. Ne pas dépasser la capacité de travail de la fourche à palette.
3. Après utilisation, veuillez sécher avant de ranger le produit pour éviter la rouille.
4. Les procédures non spécifiquement expliquées dans ce manuel doivent être effectuées uniquement par un technicien qualifié.

Pour éviter des blessures graves dues à une défaillance de l'outil, ne l'utilisez pas s'il est endommagé :

Le panneau perforé doit être monté sur un mur solide.

Les panneaux perforés ne doivent pas être installés sur des murs en bois trop fins.

Les panneaux perforés ne doivent pas être installés sur des murs en bois pourris ou détachés.

Le poids des objets à accrocher ne doit pas dépasser la charge du panneau perforé.

Lors du remplacement du crochet, celui-ci doit être sélectionné pour correspondre à la taille du panneau perforé.

Évitez les objets pointus, les lames et autres objets tranchants qui rayent le produit.



PRUDENCE:

Lisez attentivement les instructions et les procédures pour des opérations en toute sécurité.

Sauvegarder ce manuel

MODEL AND PARAMETERS

Model SPEC.	SKU1- KIT DE PANNEAU PERFORÉ	SKU2- KIT DE PANNEAU PERFORÉ	SKU3- KIT DE PANNEAU PERFORÉ
Matériel	Acier	Acier	Acier
Capacité de poids max. (panneau perforé simple)	44 livres	44 livres	44 livres
Taille du panneau perforé (L x l)	24x12 pouces	24x12 pouces	24x12 pouces
Spécification du trou	6 mm	6 mm	6 mm
Nombre	2 pièces	3 pièces	4 pièces
Couleur	noir	noir	noir
Model SPEC.	SKU4- KIT DE PANNEAU PERFORÉ	SKU5- KIT DE PANNEAU PERFORÉ	SKU6- KIT DE PANNEAU PERFORÉ
Matériel	Acier	Acier	Acier
Capacité de poids max. (panneau perforé simple)	44 livres	44 livres	44 livres
Taille du panneau	32x16 pouces	24x12 pouces	24x12 pouces

perforé (L x l)			
Spécification du trou	6 mm	6 mm	6 mm
Nombre	2 pièces	2 pièces	4 pièces
Couleur	noir	noir	noir

COMPONENTS

Model Parts	SKU1-KIT DE PANNEAU PERFORÉ	KIT DE PANNEAU PERFORÉ SKU2	SKU3-KIT DE PANNEAU PERFORÉ	SKU4-KIT DE PANNEAU PERFORÉ
Panneau perforé	×2	×3	×4	×2
Fiche d'extension	×8	×12	×16	×8
Vis autotaraudeuse	×8	×12	×16	×8
Manuel d'utilisation	×1	×1	×1	×1
Model Parts	KIT DE PANNEAU PERFORÉ SKU5	KIT DE PANNEAU PERFORÉ SKU6		
Panneau perforé	×2	×4		
Fiche d'extension	×8	×16		
Vis autotaraudeuse	×8	×16		
Manuel d'utilisation	×1	×1		

4 pouces Crochet	×10	×10		
Crochet en L	×10	×10		
Crochet en V	×12	×12		
Pince H plus ancienne	×8	×8		
Serrure à pêne	×30	×30		
2 pouces Crochet	/	×10		
Crochet double	/	×10		
Cadre de travail à 6 anneaux	/	×1		
Travail B en	/	×4		



Expansion Plug



Self-tapping Screw



Double Hook



4inch Hook



2inch Hook



V Hook



L Hook



Pliers Holder



Bolt Lock



6 Ring Work Frame



Work Bin

INSTALLATION INSTRUCTION

Préparation de l'installation :

7. Deux personnes ou plus pour assembler le panneau perforé.
8. Veuillez préparer un tapis ou un paillason pour protéger votre sol . Vous devez étaler tous les accessoires.
9. Veuillez préparer des gants pour éviter d'être rayé par des pièces tranchantes qui pourraient survenir lors de l'installation.
10. Veuillez ouvrir toutes les boîtes pour vérifier si les accessoires sont complets et en bon état.
11. Si vous devez utiliser des outils électriques pour installer ce produit, veuillez régler la vitesse sur basse à l'avance.
12. Lors de l'installation, veuillez aligner tous les trous et ne serrez pas toutes les vis au préalable . Sinon , cela pourrait rendre l'installation difficile.

Procédure d'installation :

ÉTAPE 1 : Placez la planche suspendue près du mur installé et marquez les trous avec un clou fin ou un crayon. (Remarque : deux trous à gauche, deux trous à droite)

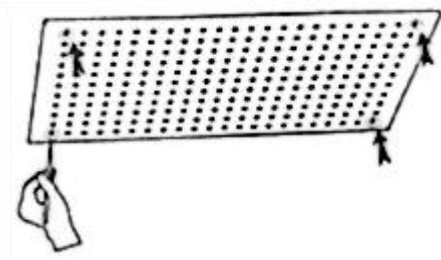

ÉTAPE 2 :

Pour l'installation de murs en béton et Bloc de montage + installation sur mur en béton :

Percez des trous de 8 mm de diamètre et de 40 mm de profondeur aux

endroits marqués, clouez complètement les quatre chevilles d'expansion dans le trou.

(Remarque : préparez vos propres outils de perçage .)

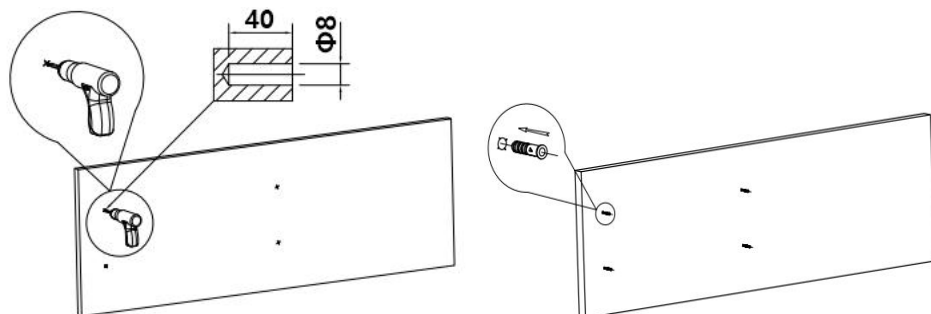

Pour l'installation de poteaux muraux en bois :

Percez des trous de 3 mm de diamètre et de 40 mm de profondeur aux endroits marqués. (Remarque : préparez vos propres outils de perçage .)

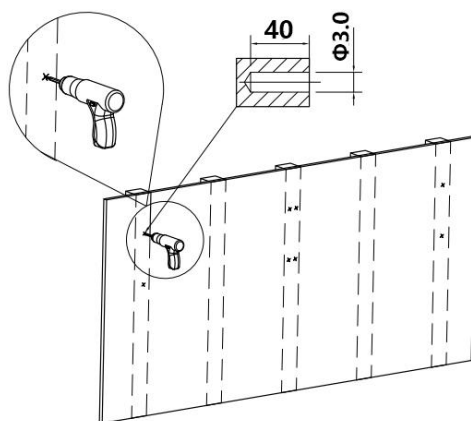

ÉTAPE 3 : À l'aide d'un tournevis, fixez le panneau perforé avec les vis au mur.

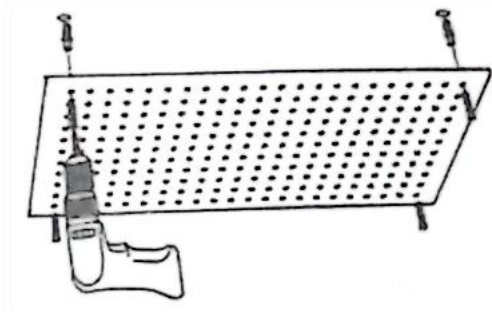

ÉTAPE 4 : Suivez les étapes ci-dessus pour installer d'autres panneaux perforés.

(Remarque : le panneau perforé est placé horizontalement et verticalement, et la méthode d'installation est la même.)

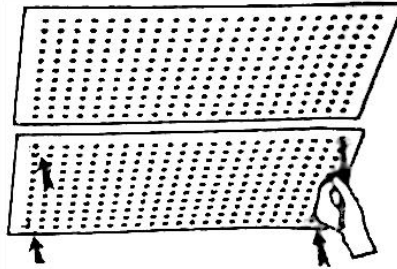

ÉTAPE 5 : Installez les autres accessoires.

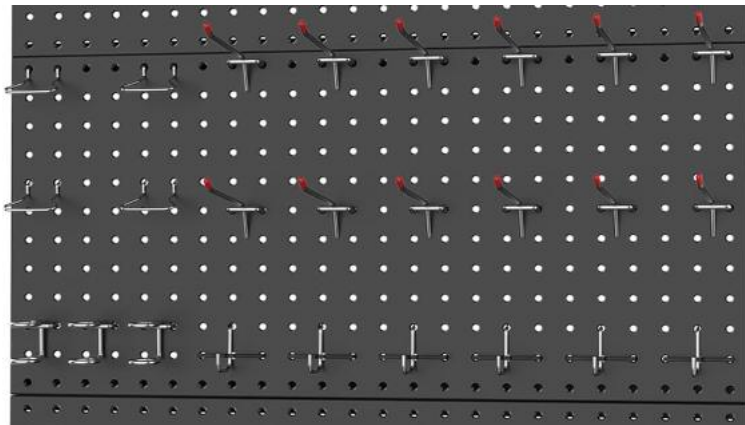

MAINTENANCE

- Ne pas dépasser la capacité de poids.
- Après utilisation, veuillez nettoyer et sécher le produit dans un endroit sec et aéré.

Fabricant : Shanghaimuxinmuyeyouxiangongsi

Adresse : Shuangchenglu 803nong11hao1602A-1609shi, baoshanqu, shanghai 200000 CN.

Importé en Australie : SIHAO PTY LTD. 1 ROKEVA STREETEASTWOOD NSW 2122 Australie

Importé aux États-Unis : Sanven Technology Ltd. Suite 250, 9166 Anaheim Place, Rancho Cucamonga, CA 91730

EC	REP
-----------	------------

E-CrossStu GmbH
Mainzer Landstr.69, 60329 Frankfurt am Main.

UK	REP
-----------	------------

YH CONSULTING LIMITED.
C/O YH Consulting Limited Office 147, Centurion House,
London Road, Staines-upon-Thames, Surrey, TW18 4AX

VEVOR[®]

TOUGH TOOLS, HALF PRICE

Technique Certificat d'assistance et de garantie électronique

www.vevor.com/support

VEVOR[®]

TOUGH TOOLS, HALF PRICE

Technisch Support und E-Garantie-Zertifikat

www.vevor.com/support

Stecktafel BEDIENUNGSANLEITUNG

**MODELL: SKU1-PEGBOARD KIT & SKU2-PEGBOARD KIT &
SKU3-PEGBOARD-KIT & SKU4-PEGBOARD-KIT &
SKU5-PEGBOARD-KIT & SKU6-PEGBOARD-KIT**

We continue to be committed to provide you tools with competitive price.

"Save Half", "Half Price" or any other similar expressions used by us only represents an estimate of savings you might benefit from buying certain tools with us compared to the major top brands and does not necessarily mean to cover all categories of tools offered by us. You are kindly reminded to verify carefully when you are placing an order with us if you are actually saving half in comparison with the top major brands.

VEVOR®

TOUGH TOOLS, HALF PRICE

PEGBOARD

MODELL: SKU1-PEGBOARD-KIT & SKU2-PEGBOARD-KIT & SKU3-PEGBOARD-KIT
& SKU4-PEGBOARD-KIT & SKU5-PEGBOARD-KIT & SKU6-PEGBOARD-KIT

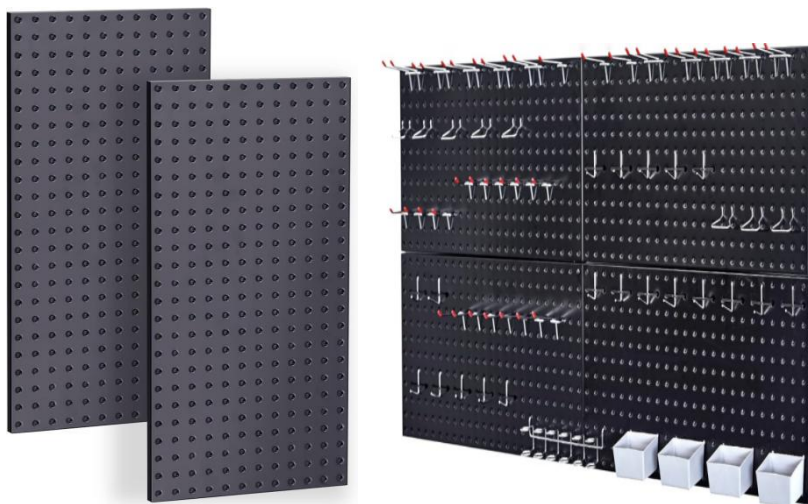

NEED HELP? CONTACT US!

Have product questions? Need technical support? Please feel free to contact us:

Technical Support and E-Warranty Certificate
www.vevor.com/support

This is the original instruction, please read all manual instructions carefully before operating. VEVOR reserves a clear interpretation of our user manual. The appearance of the product shall be subject to the product you received. Please forgive us that we won't inform you again if there are any technology or software updates on our product.

SAFETY INSTRUCTIONS



WARNUNG:

1. Lesen Sie dieses Material, bevor Sie dieses Produkt verwenden. Andernfalls kann es zu schweren Verletzungen kommen.
2. Die Arbeitskapazität der Palettengabel darf nicht überschritten werden.
3. Nach dem Gebrauch vor der Lagerung trocknen, um ein Rosten des Produkts zu vermeiden.
4. Verfahren, die in diesem Handbuch nicht ausdrücklich erläutert werden, dürfen nur von einem qualifizierten Techniker durchgeführt werden.

Um schwere Verletzungen durch Werkzeugversagen zu vermeiden, verwenden Sie es nicht , wenn es beschädigt ist:

Die Lochwand muss an einer stabilen Wand befestigt werden.

Die Lochplatten dürfen nicht an zu dünnen Holzwänden montiert werden.

Eine Montage der Lochwände an morschen oder losen Holzwänden ist nicht zulässig.

Das Gewicht der aufzuhängenden Gegenstände darf die Tragkraft der Lochwand nicht überschreiten.

Beim Austauschen der Haken muss darauf geachtet werden, dass diese passend zur Größe der Lochwand ausgewählt werden.

Vermeiden Sie scharfe Spitzen, Klingen und andere Gegenstände, die das Produkt zerkratzen könnten



VORSICHT:

Lesen Sie die Anweisungen und Verfahren für einen sicheren Betrieb sorgfältig durch.

Bewahren Sie dieses Handbuch auf

MODEL AND PARAMETERS

Model SPEC.	ARTIKELNUMME R1- STECKTAFEL-SE T	ARTIKELNUMMER 2- STECKTAFEL-SET	ARTIKELNUMMER 3- STECKTAFEL-SET
Material	Stahl	Stahl	Stahl
Max. Gewichtskapazi- tät (einzelnes Steckbrett)	44 Pfund	44 Pfund	44 Pfund
Größe der Stecktafel (L x B)	24x12 Zoll	24x12 Zoll	24x12 Zoll
Lochspez.	6 mm	6 mm	6 mm
Nummer	2 Stck.	3 Stck.	4 Stck.
Farbe	Schwarz	Schwarz	Schwarz
Model SPEC.	ARTIKELNUMME R4- STECKTAFEL-SE T	ARTIKELNUMMER 5- STECKTAFEL-SET	ARTIKELNUMMER 6- STECKTAFEL-SET
Material	Stahl	Stahl	Stahl
Max. Gewichtskapazi- tät (einzelnes Steckbrett)	44 Pfund	44 Pfund	44 Pfund
Größe der	32x16 Zoll	24x12 Zoll	24x12 Zoll

Stecktafel (L x B)			
Lochspez.	6 mm	6 mm	6 mm
Nummer	2 Stck.	2 Stck.	4 Stck.
Farbe	Schwarz	Schwarz	Schwarz

COMPONENTS

Model Parts	SKU1-STECKPLATTEN-KIT	SKU2-STECKPLATTEN-KIT	SKU3-STECKPLATTEN-KIT	SKU4-STECKPLATTEN-KIT
Stecktafel	×2	×3	×4	×2
Erweiterungsstecker	×8	×12	×16	×8
Selbstschneidende Schraube	×8	×12	×16	×8
Benutzerhandbuch	×1	×1	×1	×1
Model Parts	SKU5-STECKPLATTEN-KIT	SKU6-STECKPLATTEN-KIT		
Stecktafel	×2	×4		
Erweiterungsstecker	×8	×16		
Selbstschneidende Schraube	×8	×16		
Benutzerhandbuch	×1	×1		
4 Zoll Haken	×10	×10		

L-Haken	×10	×10		
V-Haken	×12	×12		
Zange H älter	×8	×8		
Riegelschloss	×30	×30		
2 Zoll Haken	/	×10		
Doppelhaken	/	×10		
6 - Ring - Arbeitsrahmen	/	×1		
Arbeit B in	/	×4		



Expansion Plug



Self-tapping Screw



Double Hook



4inch Hook



2inch Hook



V Hook



L Hook



Pliers Holder



Bolt Lock

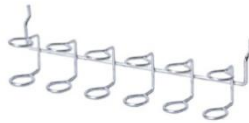

6 Ring Work Frame



Work Bin

INSTALLATION INSTRUCTION

Vorbereitung der Installation:

13. Zum Zusammenbau der Stecktafel sind zwei oder mehr Personen erforderlich.
14. Bitte legen Sie einen Teppich oder eine Matte bereit, um Ihren Boden zu schützen . Sie müssen sämtliches Zubehör ausbreiten.
15. Bitte halten Sie Handschuhe bereit, um Kratzer durch scharfe Teile zu vermeiden, die während der Installation auftreten können.
16. Bitte öffnen Sie alle Kartons, um zu prüfen, ob das Zubehör vollständig und in gutem Zustand ist.
17. Wenn Sie zur Installation dieses Produkts Elektrowerkzeuge verwenden müssen, stellen Sie die Geschwindigkeit bitte vorab auf niedrige Geschwindigkeit ein.
18. Achten Sie bei der Montage darauf, dass alle Löcher ausgerichtet sind und ziehen Sie nicht zuerst alle Schrauben fest . Andernfalls könnte die Installation erschwert werden.

Installationsverfahren:

SCHRITT 1: Platzieren Sie das Hängebrett in der Nähe der zu installierenden Wand und markieren Sie die Löcher mit einem feinen Nagel oder Bleistift. (Hinweis: Zwei Löcher links, zwei Löcher rechts)

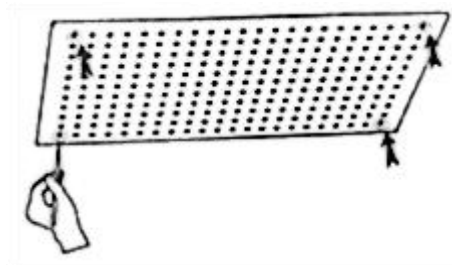

SCHRITT 2:

Für Betonwandmontage & Montageblock + Betonwandinstallation :

Bohren Sie an den markierten Stellen Löcher mit 8 mm Durchmesser und

40 mm Tiefe und nageln Sie die vier Spreizdübel vollständig in das Loch ein.

(Hinweis: Bereiten Sie Ihre eigenen Bohrwerkzeuge vor .)

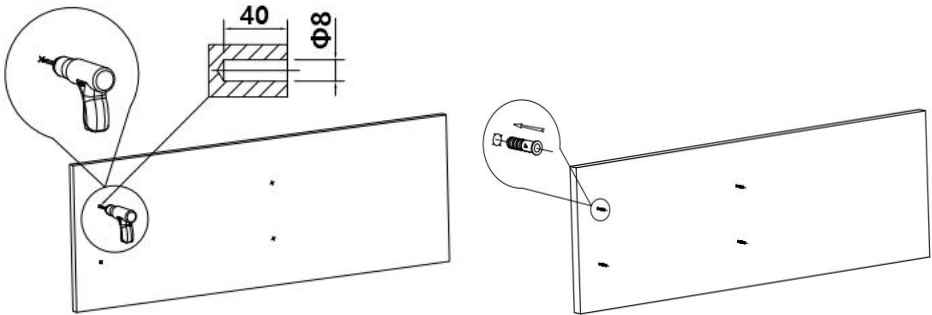

Für die Installation von hölzernen Wandpfosten:

Bohren Sie an den markierten Stellen Löcher mit 3 mm Durchmesser und 40 mm Tiefe. (Hinweis: Bereiten Sie Ihre eigenen Bohrwerkzeuge .)

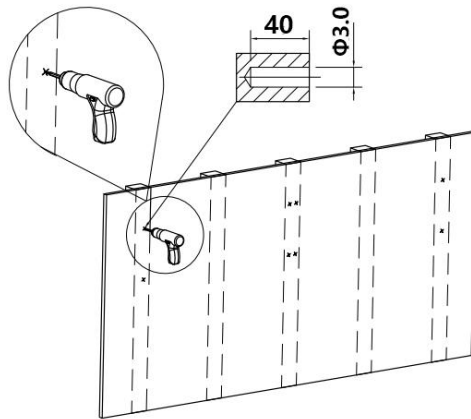

SCHRITT 3: Befestigen Sie die Stecktafel mithilfe eines Schraubenziehers mit den Schrauben an der Wand.

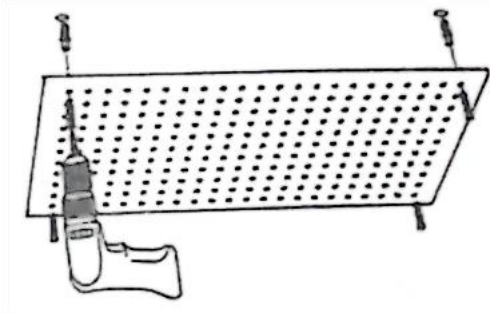

SCHRITT 4: Befolgen Sie die obigen Schritte, um andere Stecktafeln zu installieren.

(Hinweis: Die Stecktafel wird horizontal und vertikal angebracht und die Installationsmethode ist dieselbe.)

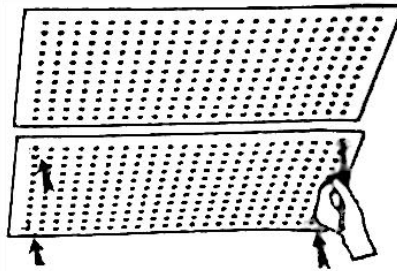

SCHRITT 5: Installieren Sie weiteres Zubehör.

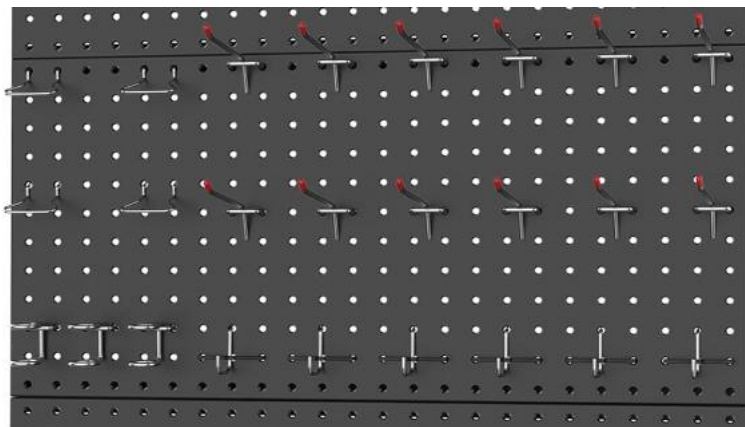

MAINTENANCE

- Überschreiten Sie nicht die Gewichtskapazität.
- Bitte reinigen und trocknen Sie das Produkt nach dem Gebrauch an einem trockenen, belüfteten Ort.

Hersteller: Shanghaimuxinmuyeyouxiangongsi

Adresse: Shuangchenglu 803nong11hao1602A-1609shi, baoshanqu, Shanghai 200000 CN.

Nach AUS importiert: SIHAO PTY LTD. 1 ROKEVA STREETEASTWOOD NSW 2122 Australien

Importiert in die USA: Sanven Technology Ltd. Suite 250, 9166 Anaheim Place, Rancho Cucamonga, CA 91730

EC	REP
----	-----

E-CrossStu GmbH
Mainzer Landstr.69, 60329 Frankfurt am Main.

UK	REP
----	-----

YH CONSULTING LIMITED.
C/O YH Consulting Limited Office 147, Centurion House,
London Road, Staines-upon-Thames, Surrey, TW18 4AX

VEVOR[®]
TOUGH TOOLS, HALF PRICE

Technisch Support und E-Garantie-Zertifikat
www.vevor.com/support

VEVOR[®]

TOUGH TOOLS, HALF PRICE

Tecnico Supporto e certificato di garanzia elettronica

www.vevor.com/support

PANNELLO FORATO MANUALE D'USO

MODELLO: SKU1-KIT PANNELLO FORATO E SKU2-KIT PANNELLO FORATO E

**SKU3-KIT PANNELLO FORATO E SKU4-KIT PANNELLO FORATO E
SKU5-KIT PANNELLO FORATO E SKU6-KIT PANNELLO FORATO**

We continue to be committed to provide you tools with competitive price.

"Save Half", "Half Price" or any other similar expressions used by us only represents an estimate of savings you might benefit from buying certain tools with us compared to the major top brands and does not necessarily mean to cover all categories of tools offered by us. You are kindly reminded to verify carefully when you are placing an order with us if you are actually saving half in comparison with the top major brands.

VEVOR[®]

TOUGH TOOLS, HALF PRICE

PEGBOARD

MODELLO:SKU1-PEGBOARD KIT E SKU2-PEGBOARD KIT E SKU3-PEGBOARD KIT
E SKU4-PEGBOARD KIT E SKU5-PEGBOARD KIT E SKU6-PEGBOARD KIT

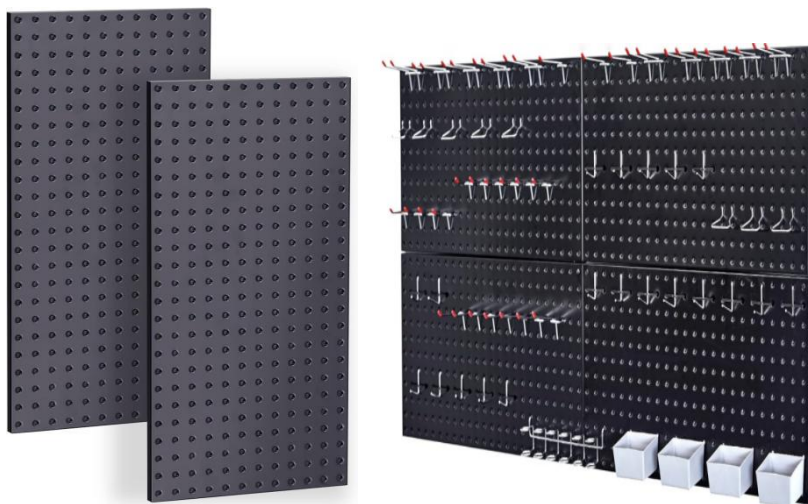

NEED HELP? CONTACT US!

Have product questions? Need technical support? Please feel free to contact us:

Technical Support and E-Warranty Certificate
www.vevor.com/support

This is the original instruction, please read all manual instructions carefully before operating. VEVOR reserves a clear interpretation of our user manual. The appearance of the product shall be subject to the product you received. Please forgive us that we won't inform you again if there are any technology or software updates on our product.

SAFETY INSTRUCTIONS



AVVERTIMENTO:

1. Leggere questo materiale prima di utilizzare questo prodotto. La mancata osservanza di questa precauzione può causare gravi lesioni.
2. Non superare la capacità di lavoro della forca per pallet.
3. Dopo l'uso, asciugare il prodotto prima di riporlo per evitare che si arrugginisca.
4. Le procedure non specificatamente spiegate nel presente manuale devono essere eseguite esclusivamente da un tecnico qualificato.

Per evitare gravi lesioni dovute a guasti dell'utensile, non utilizzarlo se è danneggiato:

Il pannello forato deve essere montato su una parete solida.

I pannelli forati non devono essere installati su pareti di legno troppo sottili.

I pannelli forati non devono essere installati su pareti in legno marce o allentate.

Il peso degli oggetti da appendere non deve superare il carico del pannello forato.

Quando si sostituisce il gancio, è necessario selezionarne uno adatto alle dimensioni del pannello forato.

Evitare punte affilate, lame e altri oggetti che graffiano il prodotto



ATTENZIONE:

Leggere attentamente le istruzioni e le procedure per operare in sicurezza.

Salva questo manuale

MODEL AND PARAMETERS

Model SPEC.	CODICE ARTICOLO1- KIT PANNELLO FORATO	CODICE ARTICOLO2- KIT PANNELLO FORATO	CODICE ARTICOLO3- KIT PANNELLO FORATO
Materiale	Acciaio	Acciaio	Acciaio
Capacità massima di peso (pannello forato singolo)	44 libbre	44 libbre	44 libbre
Dimensioni del pannello forato (L*W)	24x12 pollici	24x12 pollici	24x12 pollici
Specifiche del foro.	6 millimetri	6 millimetri	6 millimetri
Numero	2 pezzi	3 pezzi	4 pezzi
Colore	nero	nero	nero
Model SPEC.	CODICE ARTICOLO4- KIT PANNELLO FORATO	CODICE ARTICOLO5- KIT PANNELLO FORATO	CODICE ARTICOLO 6- KIT PANNELLO FORATO
Materiale	Acciaio	Acciaio	Acciaio
Capacità massima di peso (pannello forato singolo)	44 libbre	44 libbre	44 libbre
Dimensioni del pannello forato	32x16 pollici	24x12 pollici	24x12 pollici

(L*W)			
Specifiche del foro.	6 millimetri	6 millimetri	6 millimetri
Numero	2 pezzi	2 pezzi	4 pezzi
Colore	nero	nero	nero

COMPONENTS

Model Parts	SKU1-KIT PANNELLO FORATO	SKU2-KIT PANNELLO FORATO	SKU3-KIT PANNELLO FORATO	SKU4-KIT PANNELLO FORATO
Pannello forato	×2	×3	×4	×2
Spina di espansione	×8	×12	×16	×8
Vite autofilettante	×8	×12	×16	×8
Manuale dell'utente	×1	×1	×1	×1
Model Parts	SKU5-KIT PANNELLO FORATO	SKU6-KIT PANNELLO FORATO		
Pannello forato	×2	×4		
Spina di espansione	×8	×16		
Vite autofilettante	×8	×16		
Manuale dell'utente	×1	×1		
4 pollici Gancio	×10	×10		

Gancio a L	×10	×10		
Gancio a V	×12	×12		
Pinza H più vecchio	×8	×8		
Serratura a bullone	×30	×30		
2 pollici Gancio	/	×10		
Doppio gancio	/	×10		
Telaio da lavoro ad anello 6	/	×1		
Lavoro B in	/	×4		



Expansion Plug



Self-tapping Screw



Double Hook



4inch Hook



2inch Hook



V Hook



L Hook



Pliers Holder



Bolt Lock



6 Ring Work Frame



Work Bin

INSTALLATION INSTRUCTION

Preparazione all'installazione:

19. Due o più persone per montare il pannello forato.
20. Si prega di preparare un tappeto o uno zerbino per proteggere il pavimento . Devi distribuire tutti gli accessori.
21. Si prega di indossare dei guanti per evitare di graffiarsi con parti taglienti che potrebbero presentarsi durante l'installazione.
22. Si prega di aprire tutte le scatole per verificare che gli accessori siano completi e in buone condizioni.
23. Se per installare questo prodotto è necessario utilizzare utensili elettrici, impostare in anticipo la velocità su bassa.
24. Durante l'installazione, allineare tutti i fori e non stringere prima tutte le viti . Altrimenti l'installazione potrebbe risultare difficoltosa.

Procedura di installazione:

FASE 1: Posizionare la tavola sospesa vicino alla parete installata e segnare i fori con un chiodo sottile o una matita. (Nota: due fori a sinistra, due fori a destra)

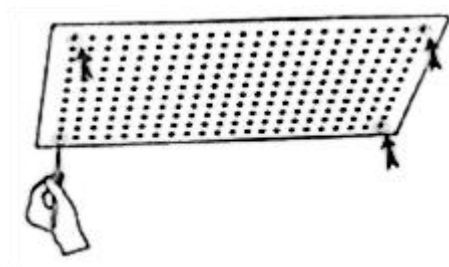

PASSO 2:

Per l'installazione di pareti in calcestruzzo e Installazione del blocco di montaggio + parete in calcestruzzo:

Praticare dei fori da 8 mm di diametro e 40 mm di profondità nei punti contrassegnati e inchiodare completamente i quattro tasselli ad espansione nel foro.

(Nota: preparare i propri utensili per la perforazione .)

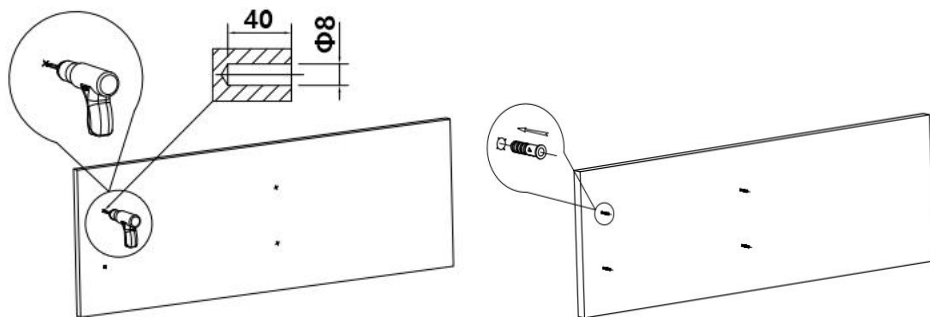

Per l'installazione del palo della parete in legno:

Praticare dei fori di 3 mm di diametro e 40 mm di profondità nei punti contrassegnati. (Nota: preparare i propri utensili da perforazione .)

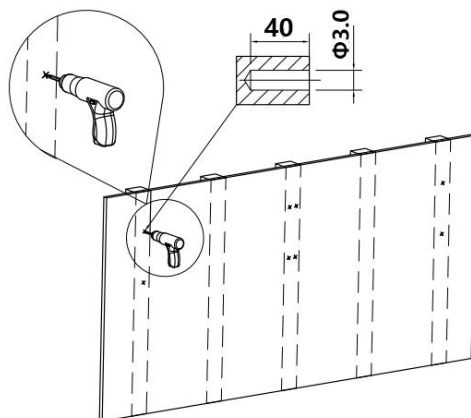

FASE 3: Con l'aiuto di un cacciavite, fissare il pannello forato alla parete con le viti.

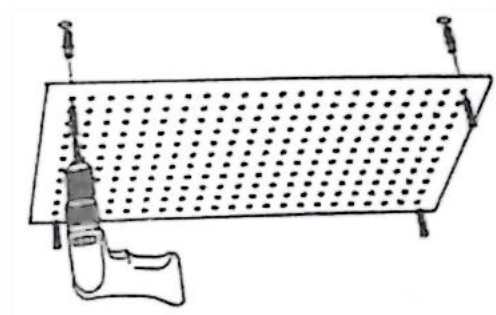

PASSO 4: Per installare altri pannelli forati, seguire i passaggi sopra indicati.

(Nota: il pannello forato viene posizionato orizzontalmente e verticalmente e il metodo di installazione è lo stesso.)

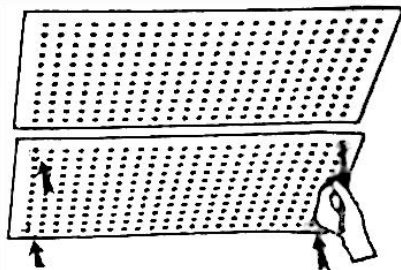

FASE 5: Installare altri accessori.

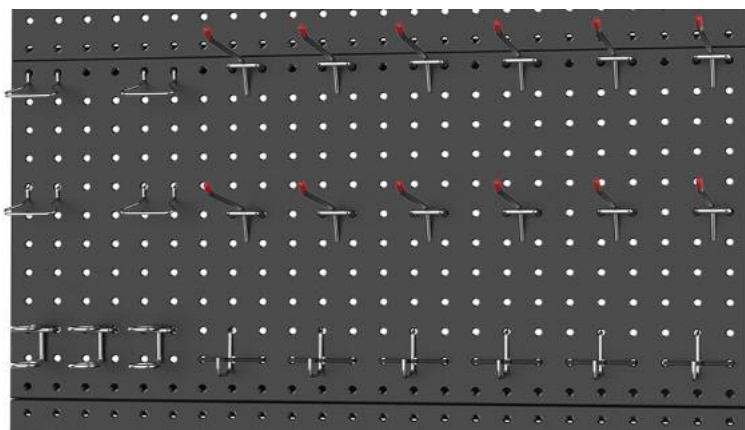

MAINTENANCE

- Non superare la capacità di peso.
- Dopo l'uso, pulire e asciugare il prodotto in un luogo asciutto e ventilato.

Produttore: Shanghai muxinmuyeyouxiangongsi

Indirizzo: Shuangchenglu 803nong11hao1602A-1609shi, baoshanqu, shanghai 200000 CN.

Importato in AUS: SIHAO PTY LTD. 1 ROKEVA STREETEASTWOOD NSW 2122 Australia

Importato negli USA: Sanven Technology Ltd. Suite 250, 9166 Anaheim Place, Rancho Cucamonga, CA 91730

EC	REP
-----------	------------

E-CrossStu GmbH
Mainzer Landstr.69, 60329 Frankfurt am Main.

UK	REP
-----------	------------

YH CONSULTING LIMITED.
C/O YH Consulting Limited Office 147, Centurion House,
London Road, Staines-upon-Thames, Surrey, TW18 4AX

VEVOR[®]
TOUGH TOOLS, HALF PRICE

Tecnico Supporto e certificato di garanzia elettronica
www.vevor.com/support

VEVOR[®]

TOUGH TOOLS, HALF PRICE

Técnico Certificado de soporte y garantía electrónica

www.vevor.com/support

TABLERO DE CLAVIJAS MANUAL DE USUARIO

**MODELO: SKU1-KIT DE TABLERO Y SKU2-KIT DE TABLERO Y
SKU3-KIT DE TABLERO Y SKU4-KIT DE TABLERO Y
KIT DE TABLERO SKU5 Y KIT DE TABLERO SKU6**

We continue to be committed to provide you tools with competitive price.

"Save Half", "Half Price" or any other similar expressions used by us only represents an estimate of savings you might benefit from buying certain tools with us compared to the major top brands and does not necessarily mean to cover all categories of tools offered by us. You are kindly reminded to verify carefully when you are placing an order with us if you are actually saving half in comparison with the top major brands.

VEVOR[®]

TOUGH TOOLS, HALF PRICE

PEGBOARD

MODELO: SKU1-PEGBOARD KIT & SKU2-PEGBOARD KIT & SKU3-PEGBOARD KIT &
SKU4-PEGBOARD KIT & SKU5-PEGBOARD KIT & SKU6-PEGBOARD KIT

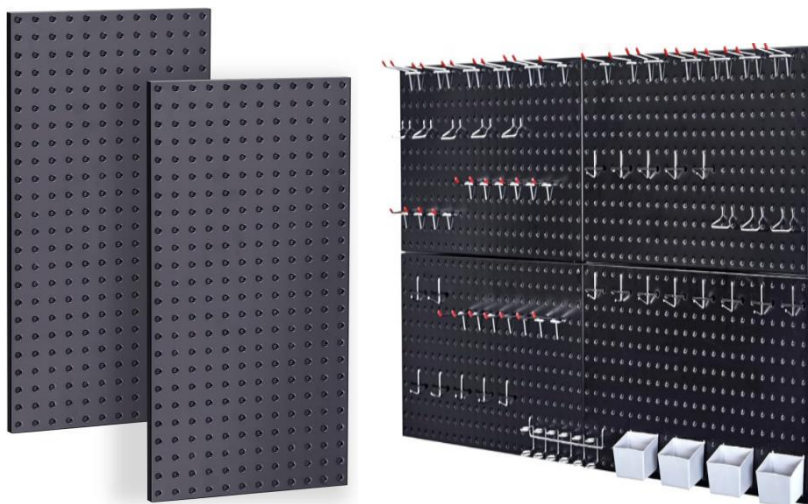

NEED HELP? CONTACT US!

Have product questions? Need technical support? Please feel free to contact us:

Technical Support and E-Warranty Certificate
www.vevor.com/support

This is the original instruction, please read all manual instructions carefully before operating. VEVOR reserves a clear interpretation of our user manual. The appearance of the product shall be subject to the product you received. Please forgive us that we won't inform you again if there are any technology or software updates on our product.

SAFETY INSTRUCTIONS



ADVERTENCIA:

1. Lea este material antes de utilizar este producto. De lo contrario, podría sufrir lesiones graves.
2. No exceda la capacidad de trabajo de la horquilla para paletas.
3. Después del uso, séquelo antes de guardarlo para evitar la oxidación del producto.
4. Los procedimientos no explicados específicamente en este manual deben ser realizados únicamente por un técnico calificado.

Para evitar lesiones graves debido a fallas de la herramienta, no la utilice si está dañada:

El tablero perforado debe montarse en una pared sólida.

Los tableros perforados no se deben instalar en paredes de madera demasiado delgadas.

Los tableros perforados no se deben instalar en paredes de madera podridas o sueltas.

El peso de los objetos a colgar no debe exceder la carga del tablero perforado.

Al reemplazar el gancho, debe seleccionarse para que coincida con el tamaño del tablero perforado.

Evite puntas afiladas, cuchillas y otros elementos que rayen el producto.



PRECAUCIÓN:

Lea atentamente las instrucciones y los procedimientos para realizar operaciones seguras.

Guarde este manual

MODEL AND PARAMETERS

Model SPEC.	CÓDIGO 1- KIT DE TABLERO DE CLAVIJAS	CÓDIGO 2- KIT DE TABLERO DE CLAVIJAS	CÓDIGO 3- KIT DE TABLERO DE CLAVIJAS
Material	Acero	Acero	Acero
Capacidad máxima de peso (tablero perforado individual)	44 libras	44 libras	44 libras
Tamaño del tablero perforado (L*A)	24 x 12 pulgadas	24 x 12 pulgadas	24 x 12 pulgadas
Especificacione s del agujero.	6 mm	6 mm	6 mm
Número	2 piezas	3 piezas	4 piezas
Color	negro	negro	negro
Model SPEC.	CÓDIGO 4- KIT DE TABLERO DE CLAVIJAS	CÓDIGO 5- KIT DE TABLERO DE CLAVIJAS	CÓDIGO 6- KIT DE TABLERO DE CLAVIJAS
Material	Acero	Acero	Acero
Capacidad máxima de peso (tablero perforado individual)	44 libras	44 libras	44 libras

Tamaño del tablero perforado (L*A)	32 x 16 pulgadas	24 x 12 pulgadas	24 x 12 pulgadas
Especificaciones del agujero.	6 mm	6 mm	6 mm
Número	2 piezas	2 piezas	4 piezas
Color	negro	negro	negro

COMPONENTS

Model Parts	SKU1-KIT DE TABLERO DE CLAVIJAS	KIT DE TABLERO DE CLAVIJAS SKU2	KIT DE TABLERO DE CLAVIJAS SKU3	KIT DE TABLERO DE CLAVIJAS SKU4
Tablero perforado	×2	×3	×4	×2
Tapón de expansión	×8	×12	×16	×8
Tornillo autorroscante	×8	×12	×16	×8
Manual del usuario	×1	×1	×1	×1
Model Parts	KIT DE TABLERO DE CLAVIJAS SKU5	KIT DE TABLERO DE CLAVIJAS SKU6		
Tablero perforado	×2	×4		
Tapón de	×8	×16		

expansión				
Tornillo autorroscante	×8	×16		
Manual del usuario	×1	×1		
4 pulgadas Gancho	×10	×10		
Gancho en forma de L	×10	×10		
Gancho en V	×12	×12		
Alicates H mayores	×8	×8		
Cerradura de cerrojo	×30	×30		
2 pulgadas Gancho	/	×10		
Doble gancho	/	×10		
Marco de trabajo de 6 anillos	/	×1		
Trabajo B en	/	×4		



Expansion Plug

Self-tapping Screw



Double Hook

4inch Hook

2inch Hook

V Hook

L Hook



Pliers Holder



Bolt Lock

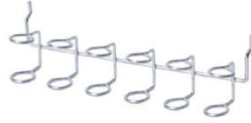

6 Ring Work Frame



Work Bin

INSTALLATION INSTRUCTION

Preparación de la instalación:

25. Se necesitan dos o más personas para montar el tablero perforado.
26. Prepare una alfombra o tapete para proteger el piso . Tienes que distribuir todos los accesorios.
27. Prepare guantes para evitar rayarse con las piezas afiladas que puedan producirse durante la instalación.
28. Abra todas las cajas para comprobar si los accesorios están completos y en buenas condiciones.
29. Si necesita utilizar herramientas eléctricas para instalar este producto, configure la velocidad a baja con anticipación.
30. Al instalar, alinee todos los orificios y no apriete todos los tornillos primero . De lo contrario, podría dificultar la instalación.

Procedimiento de instalación:

PASO 1: Coloque el tablero colgante cerca de la pared instalada y marque los agujeros con un clavo fino o un lápiz. (Nota: dos agujeros a la izquierda, dos agujeros a la derecha)

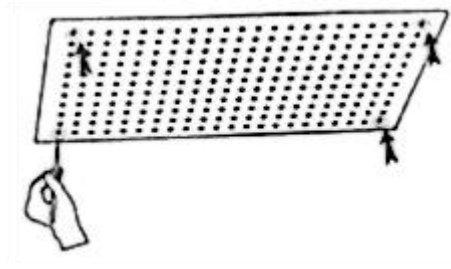

PASO 2:

Para instalación de paredes de hormigón y Bloque de montaje + Instalación en pared de hormigón:

Perfore agujeros de 8 mm de diámetro y 40 mm de profundidad en los lugares marcados, clave los cuatro tacos de expansión completamente en el agujero.

(Nota: Prepare sus propias herramientas de perforación).

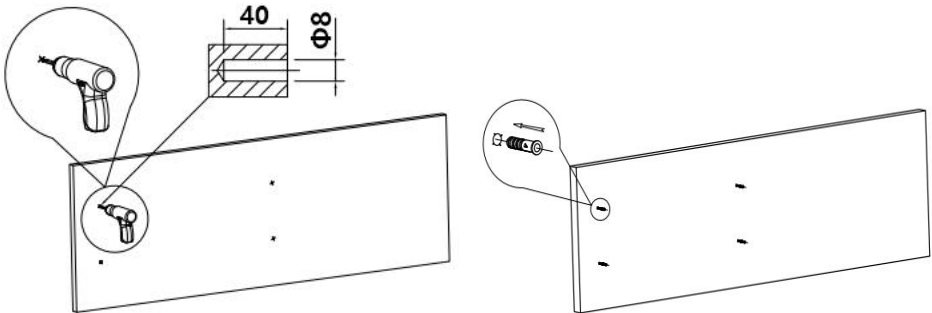

Para instalación de postes de madera en la pared:

Perfore agujeros de 3 mm de diámetro y 40 mm de profundidad en los lugares marcados. (Nota: Prepare sus propios agujeros) herramientas de perforación .)

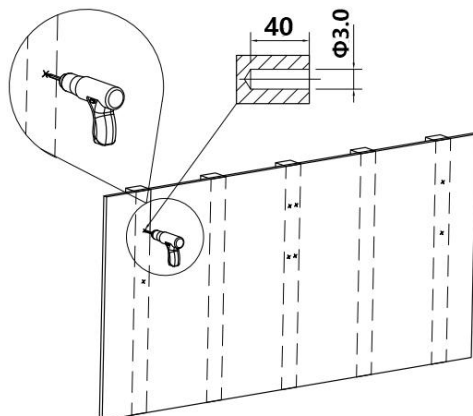

PASO 3: Con ayuda de un destornillador, fija el tablero perforado con los tornillos a la pared.

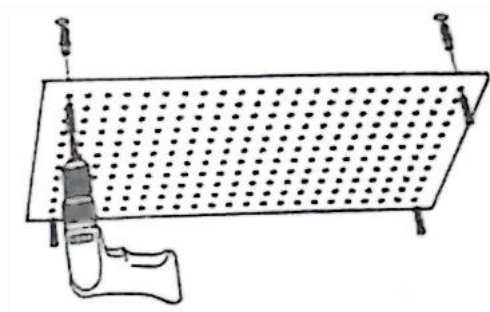

PASO 4: Siga los pasos anteriores para instalar otros tableros perforados. (Nota: El tablero perforado se coloca horizontal y verticalmente, y el método de instalación es el mismo).

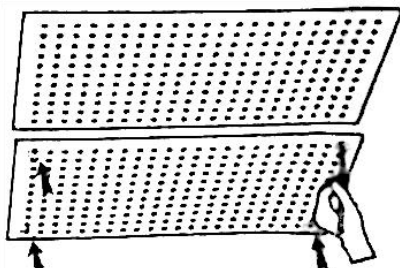

PASO 5: Instale otros accesorios.

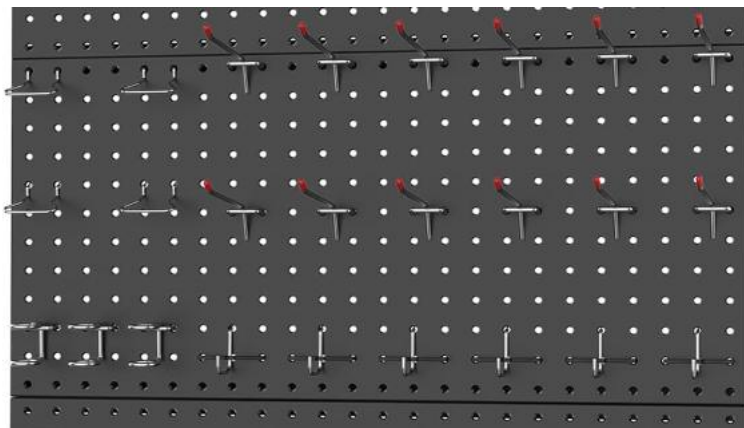

MAINTENANCE

- No exceda la capacidad de peso.
- Después de su uso, limpie y seque el producto en un lugar seco y ventilado.

Fabricante: Shanghai muxin muyeyouxiangongsi

Dirección: Shuangchenglu 803nong11hao1602A-1609shi, baoshanqu, shanghai 200000 CN.

Importado a AUS: SIHAO PTY LTD. 1 ROKEVA STREET EASTWOOD NSW 2122 Australia

Importado a EE. UU.: Sanven Technology Ltd. Suite 250, 9166 Anaheim Place, Rancho Cucamonga, CA 91730

EC	REP
-----------	------------

E-CrossStu GmbH
Mainzer Landstr.69, 60329 Frankfurt am Main.

UK	REP
-----------	------------

YH CONSULTING LIMITED.
C/O YH Consulting Limited Office 147, Centurion House,
London Road, Staines-upon-Thames, Surrey, TW18 4AX

VEVOR[®]
TOUGH TOOLS, HALF PRICE

Técnico Certificado de soporte y garantía electrónica
www.vevor.com/support

VEVOR[®]

TOUGH TOOLS, HALF PRICE

Techniczny Wsparcie i certyfikat e-gwarancji

www.vevor.com/support

PŁYTA PERGLOWANA INSTRUKCJA OBSŁUGI

**MODEL: SKU1-ZESTAW PEGBOARD & SKU2-ZESTAW PEGBOARD &
SKU3-ZESTAW PEGBOARD & SKU4-ZESTAW PEGBOARD &
ZESTAW SKU5-PEGBOARD I ZESTAW SKU6-PEGBOARD**

We continue to be committed to provide you tools with competitive price.

"Save Half", "Half Price" or any other similar expressions used by us only represents an estimate of savings you might benefit from buying certain tools with us compared to the major top brands and does not necessarily mean to cover all categories of tools offered by us. You are kindly reminded to verify carefully when you are placing an order with us if you are actually saving half in comparison with the top major brands.

VEVOR[®]

TOUGH TOOLS, HALF PRICE

PEGBOARD

MODEL: SKU1-ZESTAW PEGBOARD & SKU2-ZESTAW PEGBOARD &
SKU3-ZESTAW PEGBOARD & SKU4-ZESTAW PEGBOARD & SKU5-ZESTAW
PEGBOARD & SKU6-ZESTAW PEGBOARD

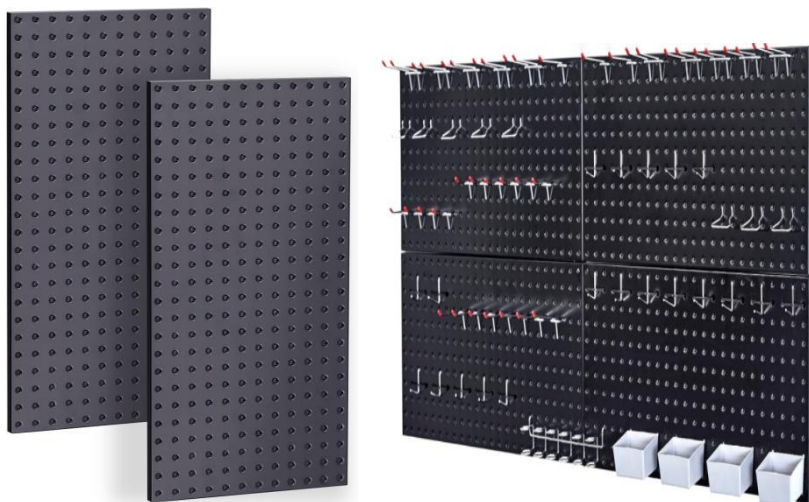

NEED HELP? CONTACT US!

Have product questions? Need technical support? Please feel free to contact us:

Technical Support and E-Warranty Certificate
www.vevor.com/support

This is the original instruction, please read all manual instructions carefully before operating. VEVOR reserves a clear interpretation of our user manual. The appearance of the product shall be subject to the product you received. Please forgive us that we won't inform you again if there are any technology or software updates on our product.

SAFETY INSTRUCTIONS



OSTRZEŻENIE:

1. Przeczytaj ten materiał przed użyciem tego produktu. Niedopełnienie tego obowiązku może spowodować poważne obrażenia.
2. Nie przekraczać dopuszczalnego udźwigu wideł paletowych.
3. Po użyciu należy wysuszyć produkt przed schowaniem, aby zapobiec jego rdzewieniu.
4. Procedury, które nie zostały szczegółowo opisane w niniejszej instrukcji, mogą być wykonywane wyłącznie przez wykwalifikowanego technika.

Aby zapobiec poważnym obrażeniom spowodowanym awarią narzędzia, nie należy go używać , gdy jest uszkodzone:

Tablicę perforowaną należy zamontować na ścianie litej.

Tablic perforowanych nie należy montować na zbyt cienkich ścianach drewnianych.

Nie wolno montować tablic perforowanych na zgniłych lub luźnych ścianach drewnianych.

Ciężar przedmiotów przeznaczonych do zawieszenia nie może przekraczać obciążenia tablicy perforowanej.

Przy wymianie haka należy pamiętać o dobraniu go do rozmiaru tablicy perforowanej.

Unikaj ostrych punktów, ostrzy i innych przedmiotów, które mogą zarysować produkt.



OSTROŻNOŚĆ:

Uważnie przeczytaj instrukcje i procedury w celu zapewnienia bezpiecznego działania.

Zapisz ten podręcznik

MODEL AND PARAMETERS

Model SPEC.	SKU1- ZESTAW PEGBOARD	SKU2- ZESTAW PEGBOARDOWY	SKU3- ZESTAW PEGBOARD
Tworzywo	Stal	Stal	Stal
Maksymalna nośność (pojedyncza tablica perforowana)	44 funty	44 funty	44 funty
Wymiary tablicy perforowanej (dł. x szer.)	24x12 cali	24x12 cali	24x12 cali
Specyfikacja otworów	6mm	6mm	6mm
Numer	2 szt.	3 szt.	4 szt.
Kolor	czarny	czarny	czarny
Model SPEC.	SKU4- ZESTAW PEGBOARDOWY	SKU5- ZESTAW PEGBOARDOWY	SKU6- ZESTAW PEGBOARDOWY

Tworzywo	Stal	Stal	Stal
Maksymalna nośność (pojedyncza tablica perforowana)	44 funty	44 funty	44 funty
Wymiary tablicy perforowanej (dł. x szer.)	32x16 cali	24x12 cali	24x12 cali
Specyfikacja otworów	6mm	6mm	6mm
Numer	2 szt.	2 szt.	4 szt.
Kolor	czarny	czarny	czarny

COMPONENTS

Model Parts	SKU1-ZEST AW PEGBOARD	SKU2-ZEST AW PEGBOARD	SKU3-ZEST AW PEGBOARD	SKU4-ZEST AW PEGBOARD
Tablica perforowana	×2	×3	×4	×2
Wtyczka rozprężna	×8	×12	×16	×8
Wkręt samogwintujący	×8	×12	×16	×8
Instrukcja obsługi	×1	×1	×1	×1
Model Parts	SKU5-ZEST AW PEGBOARD	SKU6-ZEST AW PEGBOARD		

Tablica perforowana	×2	×4		
Wtyczka rozprężna	×8	×16		
Wkręt samogwintujący	×8	×16		
Instrukcja obsługi	×1	×1		
4 cale Hak	×10	×10		
Hak L	×10	×10		
Hak V	×12	×12		
Szczypce H starsze	×8	×8		
Zamek ryglowy	×30	×30		
2 cale Hak	/	×10		
Podwójny hak	/	×10		
Rama robocza 6 - pierścieniowa	/	×1		
Praca B w	/	×4		



Expansion Plug



Self-tapping Screw



Double Hook



4inch Hook



2inch Hook



V Hook



L Hook



Pliers Holder



Bolt Lock



6 Ring Work Frame



Work Bin

INSTALLATION INSTRUCTION

Przygotowanie do instalacji:

31. Dwie lub więcej osób do montażu tablicy perforowanej.
32. Proszę przygotować dywan lub matę, aby zabezpieczyć podłogę . Musisz rozłożyć wszystkie akcesoria.
33. Proszę przygotować rękawice, aby uniknąć zarysowań ostrymi elementami, które mogą powstać w trakcie montażu.
34. Proszę otworzyć wszystkie pudełka, aby sprawdzić , czy akcesoria są kompletne i w dobrym stanie.
35. Jeśli do montażu tego produktu konieczne będzie użycie elektronarzędzi, należy wcześniej ustawić niską prędkość.
36. Podczas montażu należy wyrównać wszystkie otwory i nie dokręcać najpierw wszystkich śrub . W przeciwnym wypadku instalacja może być utrudniona.

Procedura instalacji:

KROK 1: Umieść deskę wiszącą w pobliżu zamontowanej ściany i zaznacz otwory cienkim gwoździem lub ołówkiem. (Uwaga: dwa otwory po lewej stronie, dwa otwory po prawej stronie)

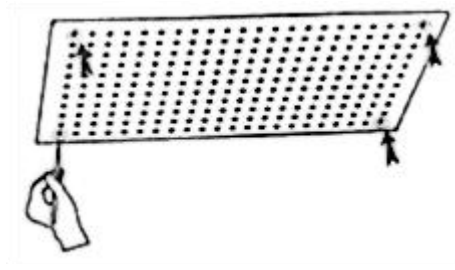

KROK 2:

Do montażu ścian betonowych i Montaż blokady + montaż na ścianie betonowej :

Wywierć otwory o średnicy 8 mm i głębokości 40 mm w zaznaczonych miejscach, wbij cztery kołki rozporowe do otworów.

(Uwaga: Przygotuj własne narzędzia wiertnicze .)

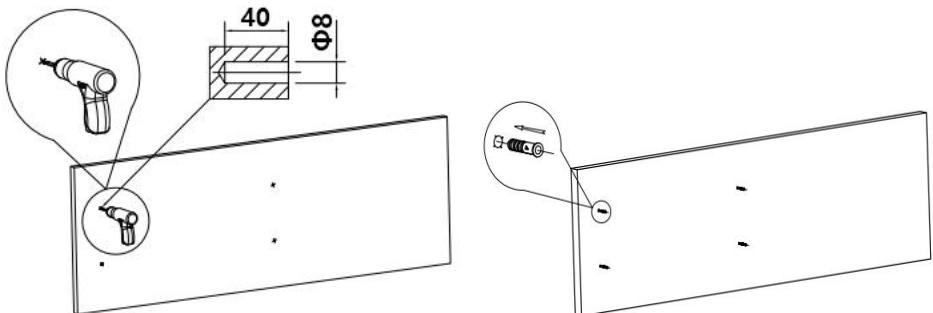

Do montażu drewnianych słupków ściennych:

Wywierć otwory o średnicy 3 mm i głębokości 40 mm w zaznaczonych miejscach. (Uwaga: Przygotuj własne otwory) narzędzia wiertnicze .)

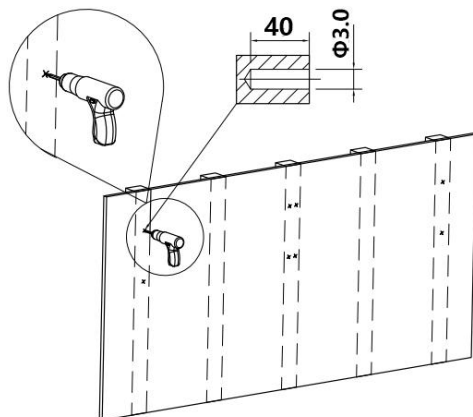

KROK 3: Za pomocą śrubokręta przymocuj płytę perforowaną do ściany za pomocą śrub.

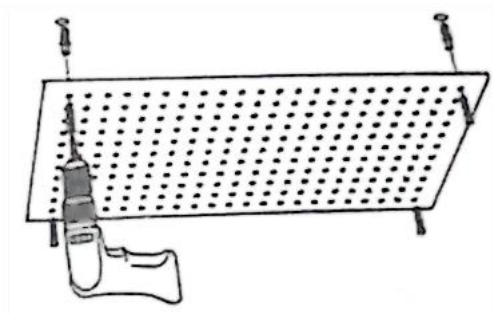

KROK 4: Aby zamontować pozostałe tablice perforowane, wykonaj powyższe czynności.

(Uwaga: Tablicę perforowaną umieszcza się poziomo i pionowo, a metoda montażu jest taka sama.)

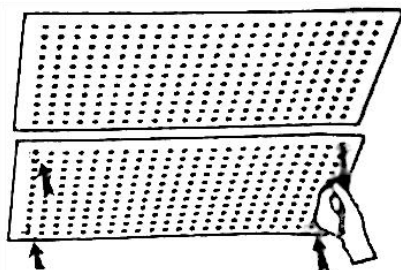

KROK 5: Zainstaluj pozostałe akcesoria.

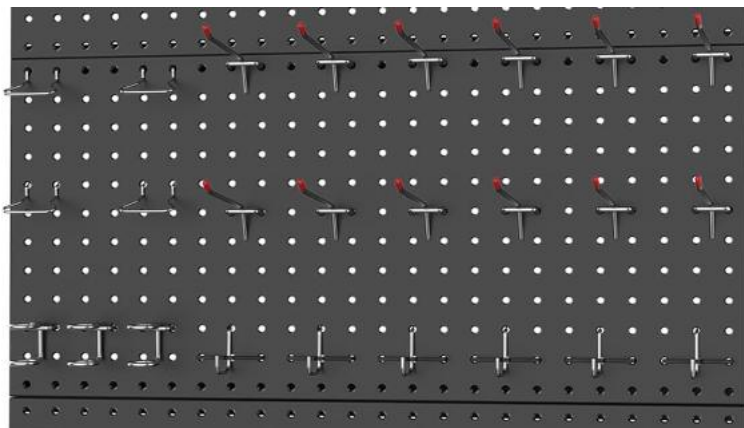

MAINTENANCE

- Nie przekraczać dopuszczalnego ciężaru.
- Po użyciu należy wyczyścić i wysuszyć produkt w suchym i wentylowanym miejscu.

Producent: Shanghaimuxinmuyeyouxiangongsi

Adres: Shuangchenglu 803nong11hao1602A-1609shi, baoshanqu, szanghaj 200000 CN.

Importowane do AUS: SIHAO PTY LTD. 1 ROKEVA STREET EASTWOOD NSW 2122 Australia

Importowane do USA: Sanven Technology Ltd. Suite 250, 9166 Anaheim Place, Rancho Cucamonga, CA 91730

EC	REP
-----------	------------

E-CrossStu GmbH
Mainzer Landstr.69, 60329 Frankfurt am Main.

UK	REP
-----------	------------

YH CONSULTING LIMITED.
C/O YH Consulting Limited Office 147, Centurion House,
London Road, Staines-upon-Thames, Surrey, TW18 4AX

VEVOR[®]

TOUGH TOOLS, HALF PRICE

Techniczny Wsparcie i certyfikat e-gwarancji

www.vevor.com/support

VEVOR[®]

TOUGH TOOLS, HALF PRICE

Technisch Ondersteuning en E-garantiecertificaat

www.vevor.com/support

PEGBOARD GEBRUIKSAANWIJZING

**MODEL: SKU1-PEGBOARD KIT & SKU2-PEGBOARD KIT &
SKU3-PEGBOARD-KIT & SKU4-PEGBOARD-KIT &
SKU5-PEGBOARD-KIT & SKU6-PEGBOARD-KIT**

We continue to be committed to provide you tools with competitive price.

"Save Half", "Half Price" or any other similar expressions used by us only represents an estimate of savings you might benefit from buying certain tools with us compared to the major top brands and does not necessarily mean to cover all categories of tools offered by us. You are kindly reminded to verify carefully when you are placing an order with us if you are actually saving half in comparison with the top major brands.

VEVOR[®]

TOUGH TOOLS, HALF PRICE

PEGBOARD

MODEL: SKU1-PEGBOARD KIT & SKU2-PEGBOARD KIT & SKU3-PEGBOARD KIT & SKU4-PEGBOARD KIT & SKU5-PEGBOARD KIT & SKU6-PEGBOARD KIT

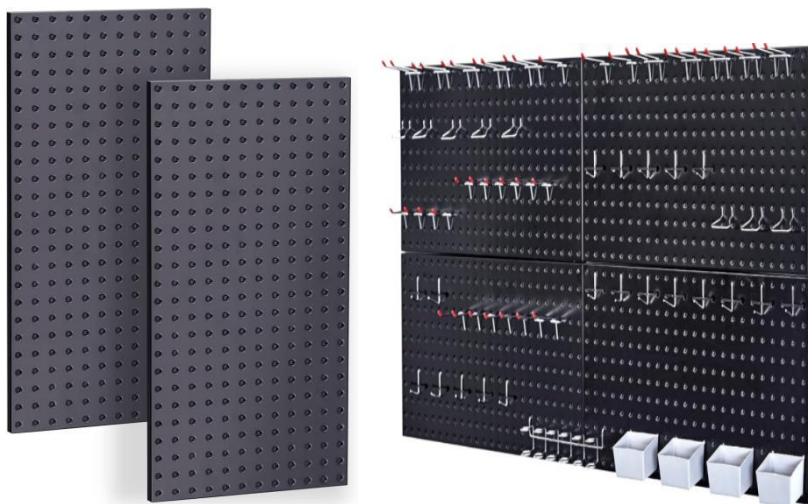

NEED HELP? CONTACT US!

Have product questions? Need technical support? Please feel free to contact us:

Technical Support and E-Warranty Certificate
www.vevor.com/support

This is the original instruction, please read all manual instructions carefully before operating. VEVOR reserves a clear interpretation of our user manual. The appearance of the product shall be subject to the product you received. Please forgive us that we won't inform you again if there are any technology or software updates on our product.

SAFETY INSTRUCTIONS



WAARSCHUWING:

1. Lees dit materiaal voordat u dit product gebruikt. Als u dit niet doet, kan dit leiden tot ernstig letsel.
2. Overschrijd de werkcapaciteit van de palletvork niet.
3. Laat het product na gebruik drogen voordat u het opbergt om roestvorming te voorkomen.
4. Procedures die niet specifiek in deze handleiding worden uitgelegd, mogen uitsluitend door een gekwalificeerde technicus worden uitgevoerd.

Om ernstig letsel door een defect aan het gereedschap te voorkomen, mag u het gereedschap niet gebruiken als het beschadigd is:

Het gaatjesbord moet aan een stevige muur worden bevestigd.

De gaatjesborden mogen niet op te dunne houten wanden worden gemonteerd.

De gaatjesborden mogen niet op rotte of losse houten wanden worden geïnstalleerd.

Het gewicht van de op te hangen artikelen mag het draagvermogen van het gaatjesbord niet overschrijden.

Bij het vervangen van de haak moet deze zo worden gekozen dat deze overeenkomt met de maat van het gaatjesbord.

Vermijd scherpe punten, messen en andere voorwerpen die het product kunnen krassen.



VOORZICHTIGHEID:

Lees de instructies en procedures zorgvuldig door voor veilige handelingen.

Bewaar deze handleiding

MODEL AND PARAMETERS

Model SPEC.	SKU1- PEGBOARD-KIT	SKU2- PEGBOARD-KIT	SKU3- PEGBOARD-KIT
Materiaal	Staal	Staal	Staal
Max. draagvermogen (enkele prikbord)	44 pond	44 pond	44 pond
Afmeting prikbord (L*B)	24x12inch	24x12inch	24x12inch
Gatspecificatie.	6mm	6mm	6mm
Nummer	2 stuks	3 stuks	4 stuks
Kleur	zwart	zwart	zwart
Model SPEC.	SKU4- PEGBOARD-KIT	SKU5- PEGBOARD-KIT	SKU6- PEGBOARD-KIT
Materiaal	Staal	Staal	Staal
Max. draagvermogen (enkele prikbord)	44 pond	44 pond	44 pond
Afmeting prikbord (L*B)	32x16inch	24x12inch	24x12inch
Gatspecificatie.	6mm	6mm	6mm
Nummer	2 stuks	2 stuks	4 stuks

Kleur	zwart	zwart	zwart
-------	-------	-------	-------

COMPONENTS

Model Parts	SKU1-PEGB OARD-KIT	SKU2-PEGB OARD-KIT	SKU3-PEGB OARD-KIT	SKU4-PEGB OARD-KIT
Pegbord	×2	×3	×4	×2
Expansieplug	×8	×12	×16	×8
Zelftappende schroef	×8	×12	×16	×8
Gebruikershandlei ding	×1	×1	×1	×1
Model Parts	SKU5-PEGB OARD-KIT	SKU6-PEGB OARD-KIT		
Pegbord	×2	×4		
Expansieplug	×8	×16		
Zelftappende schroef	×8	×16		
Gebruikershandlei ding	×1	×1		
4 inch Haak	×10	×10		
L-haak	×10	×10		
V-haak	×12	×12		
Tang H ouder	×8	×8		
Bout slot	×30	×30		
2 inch Haak	/	×10		

Dubbele haak	/	×10		
6 Ringwerkframe	/	×1		
Werk B in	/	×4		



Expansion Plug



Self-tapping Screw



Double Hook



4inch Hook



2inch Hook



V Hook



L Hook



Pliers Holder



Bolt Lock

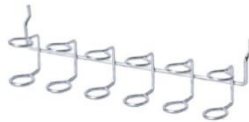

6 Ring Work Frame



Work Bin

INSTALLATION INSTRUCTION

Installatievoorbereiding:

37. Twee of meer personen om het gaatjesbord in elkaar te zetten.
38. Zorg ervoor dat u een tapijt of mat neerlegt om uw vloer te beschermen . Je moet alle accessoires uitspreiden.
39. Zorg ervoor dat u handschoenen meeneemt om te voorkomen dat u tijdens de installatie krassen oploopt door scherpe onderdelen.
40. Open alle dozen om te controleren of de accessoires compleet en in

goede staat zijn.

41. Als u elektrisch gereedschap nodig hebt om dit product te installeren, stel de snelheid dan vooraf in op een lage snelheid.

42. Zorg er bij de installatie voor dat alle gaten op één lijn liggen en draai nog niet alle schroeven vast. Anders kan het de installatie bemoeilijken.

Installatieprocedure:

STAP 1: Plaats het hangbord bij de geïnstalleerde muur en markeer de gaten met een dunne spijker of potlood. (Let op: twee gaten aan de linkerkant, twee gaten aan de rechterkant)

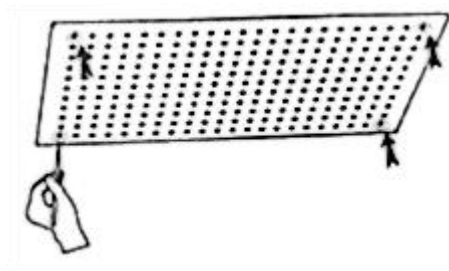

STAP 2:

Voor installatie van betonnen muren en Montageblok + Betonnen

Muur Installatie :

Boor op de gemarkeerde plaatsen gaten met een diameter van 8 mm en een diepte van 40 mm. Spijker de vier expansiepluggen volledig in het gat. (Let op: Zorg dat u uw eigen boorgereedschap bij de hand hebt.)

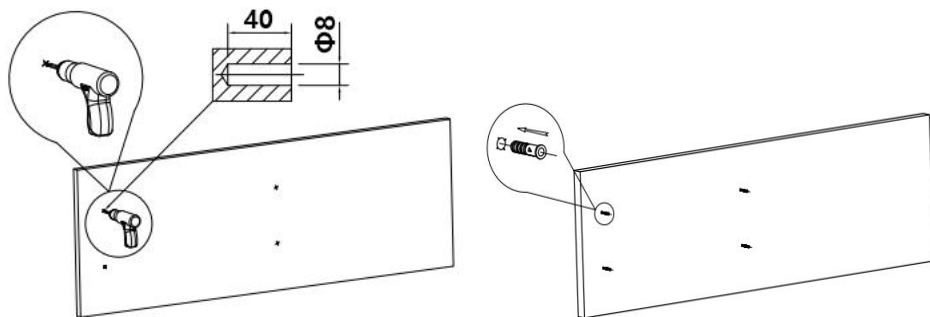

Voor installatie van houten wandpalen:

Boor gaten met een diameter van 3 mm en een diepte van 40 mm op de gemarkeerde plaatsen. (Let op: bereid uw eigen gaten voor) boorgereedschap .)

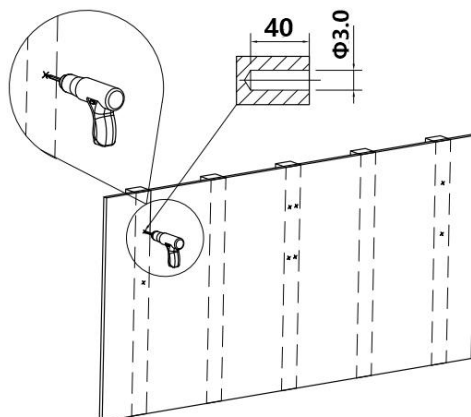

STAP 3: Bevestig het gaatjesbord met behulp van een schroevendraaier met de schroeven aan de muur.

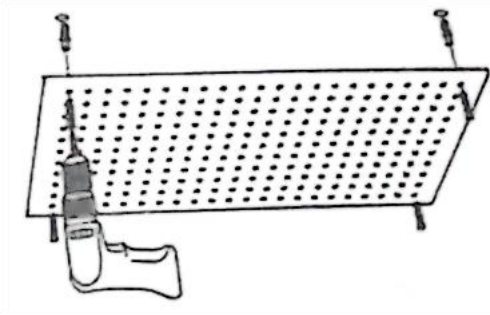

STAP 4: Volg de bovenstaande stappen om andere gaatjesborden te installeren.

(Let op: het gaatjesbord wordt horizontaal en verticaal geplaatst en de installatiemethode is hetzelfde.)

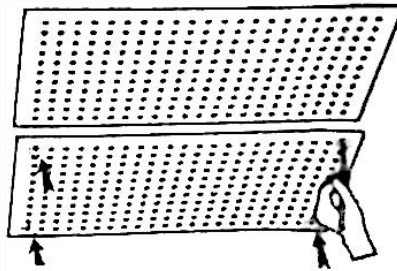

STAP 5: Installeer overige accessoires.

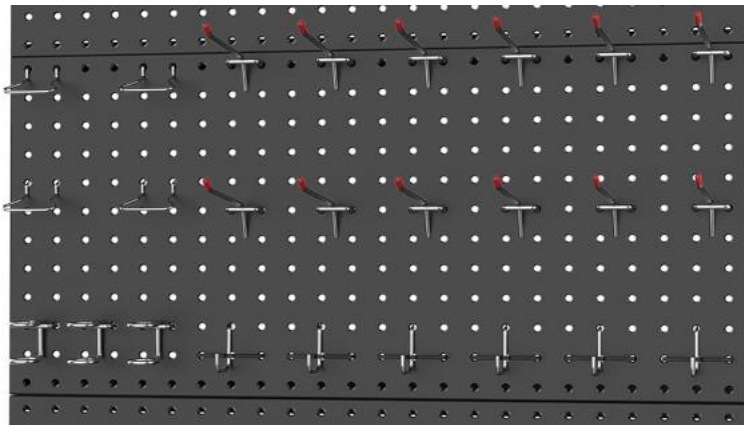

MAINTENANCE

- het toegestane gewicht niet .
- Na gebruik het product schoonmaken en laten drogen op een droge, geventileerde plaats.

Fabrikant: Shanghai muxinmuyeyouxiangongsi

Adres: Shuangchenglu 803nong11hao1602A-1609shi, baoshanqu, shanghai 200000 CN.

Geïmporteerd naar AUS: SIHAO PTY LTD. 1 ROKEVA
STREETEASTWOOD NSW 2122 Australië

Geïmporteerd naar de VS: Sanven Technology Ltd. Suite 250, 9166 Anaheim
Place, Rancho Cucamonga, CA 91730

EC	REP
-----------	------------

E-CrossStu GmbH
Mainzer Landstr.69, 60329 Frankfurt am Main.

UK	REP
-----------	------------

YH CONSULTING LIMITED.
C/O YH Consulting Limited Office 147, Centurion House,
London Road, Staines-upon-Thames, Surrey, TW18 4AX

VEVOR[®]
TOUGH TOOLS, HALF PRICE

Technisch Ondersteuning en E-garantiecertificaat
www.vevor.com/support

VEVOR[®]

TOUGH TOOLS, HALF PRICE

Teknisk Support och e-garanticertifikat

www.vevor.com/support

PEGBOARD ANVÄNDARMANUAL

**MODELL:SKU1-PEGBOARD KIT & SKU2-PEGBOARD KIT &
SKU3-PEGBOARD KIT & SKU4-PEGBOARD KIT &
SKU5-PEGBOARD-KIT & SKU6-PEGBOARD-KIT**

We continue to be committed to provide you tools with competitive price.

"Save Half", "Half Price" or any other similar expressions used by us only represents an estimate of savings you might benefit from buying certain tools with us compared to the major top brands and does not necessarily mean to cover all categories of tools offered by us. You are kindly reminded to verify carefully when you are placing an order with us if you are actually saving half in comparison with the top major brands.

VEVOR[®]

TOUGH TOOLS, HALF PRICE

PEGBOARD

MODELL:SKU1-PEGBOARD KIT & SKU2-PEGBOARD KIT & SKU3-PEGBOARD KIT &
SKU4-PEGBOARD KIT & SKU5-PEGBOARD KIT & SKU6-PEGBOARD KIT

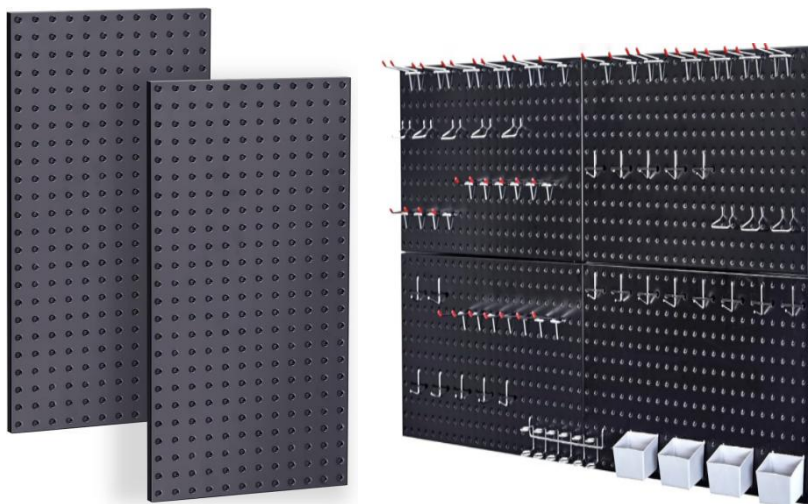

NEED HELP? CONTACT US!

Have product questions? Need technical support? Please feel free to contact us:

Technical Support and E-Warranty Certificate
www.vevor.com/support

This is the original instruction, please read all manual instructions carefully before operating. VEVOR reserves a clear interpretation of our user manual. The appearance of the product shall be subject to the product you received. Please forgive us that we won't inform you again if there are any technology or software updates on our product.

SAFETY INSTRUCTIONS



VARNING:

1. Läs detta material innan du använder denna produkt. Underlåtenhet att göra det kan resultera i allvarliga skador.
2. Överskrid inte arbetskapaciteten för pallgaffeln.
3. Efter användning, vänligen torka före förvaring för att undvika att produkten rostar.
4. Procedurer som inte specifikt förklaras i denna handbok får endast utföras av en kvalificerad tekniker.

För att förhindra allvarlig skada från verktygsfel, använd den inte när den är skadad:

Plåtbrädan måste monteras på en solid vägg.

Pinnbrädorna ska inte monteras på för tunna träväggar.

Pinnbrädorna får inte monteras på ruttna eller lösa träväggar.

Vikten av föremålen som ska hängas får inte överstiga belastningen på stiftbrädan.

Vid byte av kroken måste den väljas för att matcha storleken på pinnbrädan.

Undvik vassa spetsar, knivar och andra föremål som repar produkten



FÖRSIKTIGHET:

Läs noggrant instruktionerna och procedurerna för säker drift.

Spara denna manual

MODEL AND PARAMETERS

Model SPEC.	SKU1- PEGBOARD SAT	SKU2- PEGBOARD SAT	SKU3- PEGBOARD SAT
Material	Stål	Stål	Stål
Max. viktkapacitet (enkel stiftbräda)	44 pund	44 pund	44 pund
Pinnboard storlek (L*W)	24x12tum	24x12tum	24x12tum
Hål Spec.	6 mm	6 mm	6 mm
Antal	2 st	3 st	4 st
Färg	svart	svart	svart
Model SPEC.	SKU4- PEGBOARD SAT	SKU5- PEGBOARD SAT	SKU6- PEGBOARD SAT
Material	Stål	Stål	Stål
Max. viktkapacitet (enkel stiftbräda)	44 pund	44 pund	44 pund
Pinnboard storlek (L*W)	32x16 tum	24x12tum	24x12tum
Hål Spec.	6 mm	6 mm	6 mm
Antal	2 st	2 st	4 st
Färg	svart	svart	svart

COMPONENTS

Model Parts	SKU1-PEGB OARD SAT	SKU2-PEGB OARD SAT	SKU3-PEGB OARD SAT	SKU4-PEGB OARD KIT
Pegboard	×2	×3	×4	×2
Expansionsplugg	×8	×12	×16	×8
S elvgängande Skruv	×8	×12	×16	×8
Användarmanual	×1	×1	×1	×1
Model Parts	SKU5-PEGB OARD SAT	SKU6-PEGB OARD SAT		
Pegboard	×2	×4		
Expansionsplugg	×8	×16		
Självgängande Skruv	×8	×16		
Användarmanual	×1	×1		
4 tum H ook	×10	×10		
L Krok	×10	×10		
V-krok	×12	×12		
Tång H äldre	×8	×8		
B olt lås	×30	×30		
2 tum H ook	/	×10		
Dubbla h ook	/	×10		
6 R ing W erk ram	/	×1		
Arbeta B in	/	×4		



Expansion Plug



Self-tapping Screw



Double Hook



4inch Hook



2inch Hook



V Hook



L Hook



Pliers Holder



Bolt Lock



6 Ring Work Frame



Work Bin

INSTALLATION INSTRUCTION

Installationsförberedelser:

43. Två eller flera personer för att montera stiftbrädan.
44. Förbered en matta eller matta för att skydda ditt golv . Du måste sprida ut alla tillbehör.
45. Förbered handskar för att undvika repor av vassa delar som kan uppstå under installationen.
46. Öppna alla rutorna för att kontrollera om tillbehören är kompletta och i gott skick.
47. Om du behöver använda elverktyg för att installera den här produkten, ställ in hastigheten på låg hastighet i förväg.
48. När du installerar, vänligen rikta in alla hål och dra inte åt alla skruvar först . Annars kan det försvåra installationen.

Installationsprocedur:

STEG 1: Placera hängbrädan nära den installerade väggen och markera hålen med en fin spik eller penna. (Obs: Två hål till vänster, två hål till höger)

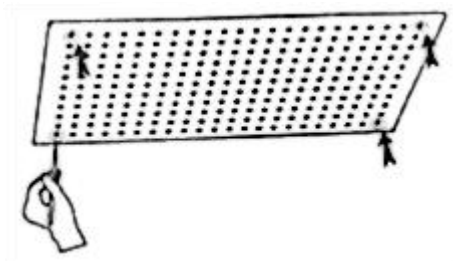

STEG 2:

För betongvägginstallation & Montering B lås + betongvägg installation :

Borra hål 8 mm i diameter och 40 mm djupa på de markerade platserna, spika fast de fyra expansionspluggarna helt i hålet.

(Obs: Förbered dina egna borrarverktyg .)

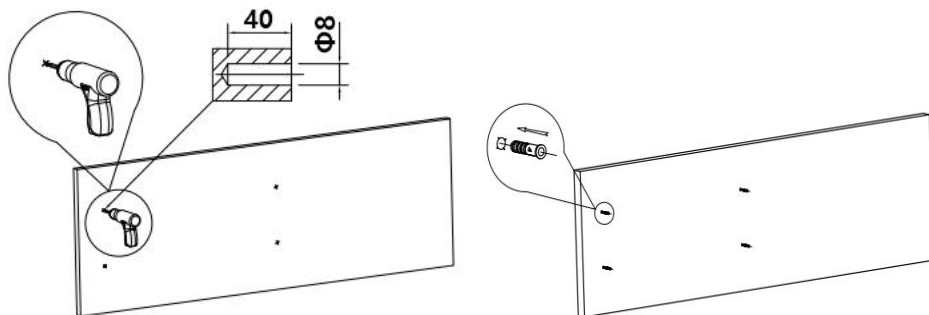

För montering av träväggstolpar:

Borra hål med en diameter på 3 mm och ett djup på 40 mm på de markerade platserna. (Obs: Förbered dina egna borrarverktyg .)

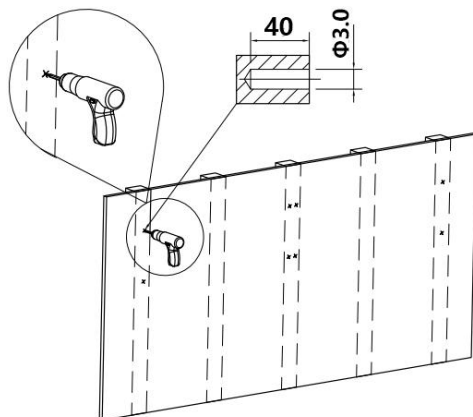

STEG 3: Fäst pinnbrädan med skruvarna på väggen med hjälp av en skruvmejsel.

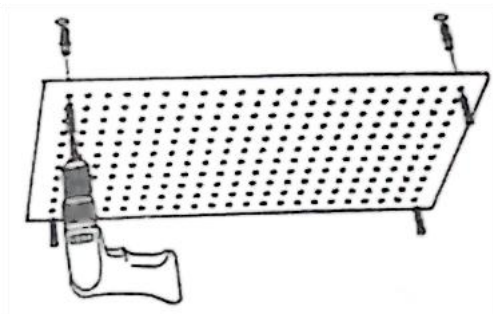

STEG 4: Följ stegen ovan för att installera andra pegboards.
(Obs: Plåtbrädan placeras horisontellt och vertikalt, och installationsmetoden är densamma.)

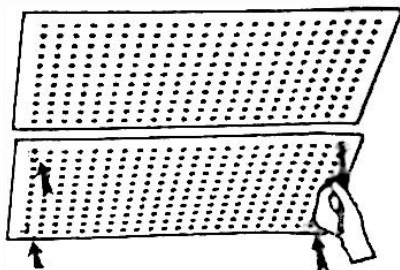

STEG 5: Installera andra tillbehör.

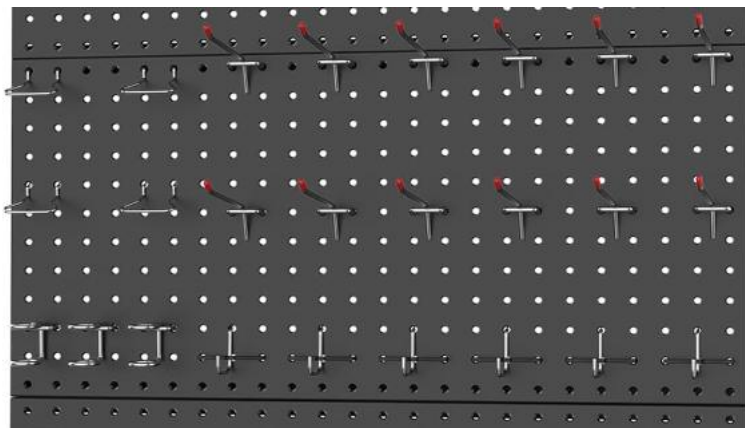

MAINTENANCE

- Överskrid inte viktkapaciteten.
- Efter användning, rengör och torka produkten på en torr och ventilerad plats.

Tillverkare: Shanghaimuxinmuyeyouxiangongsi

Adress: Shuangchenglu 803nong11hao1602A-1609shi, baoshanqu, shanghai 200000 CN.

Importerad till AUS: SIHAO PTY LTD. 1 ROKEVA STREETEASTWOOD NSW 2122 Australien

Importerad till USA: Sanven Technology Ltd. Suite 250, 9166 Anaheim Place, Rancho Cucamonga, CA 91730

EC	REP
----	-----

E-CrossStu GmbH
Mainzer Landstr.69, 60329 Frankfurt am Main.

UK	REP
----	-----

YH CONSULTING LIMITED.
C/O YH Consulting Limited Office 147, Centurion House,
London Road, Staines-upon-Thames, Surrey, TW18 4AX

VEVOR[®]
TOUGH TOOLS, HALF PRICE

Teknisk Support och e-garanticertifikat
www.vevor.com/support