

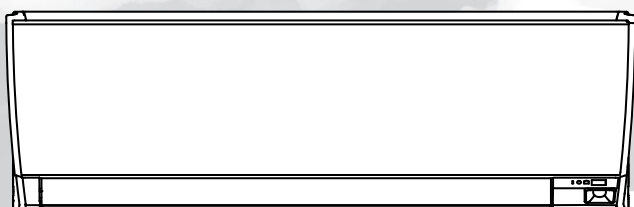

AIR CONDITIONER  
Wall Mounted Type



ASTG18KMCA  
ASTG22KMCA  
ASTG24KMCA

Before using this product, read these instructions thoroughly and keep this manual for future reference.

**⚠ CAUTION**

**R32 REFRIGERANT**

This Air Conditioner contains and operates with refrigerant R32.

THIS PRODUCT MUST ONLY BE INSTALLED OR SERVICED BY QUALIFIED PERSONNEL.

Refer to Commonwealth, State, Territory and local legislation, regulations, codes, installation & operation manuals, before the installation, maintenance or service of this product.

# OPERATING MANUAL

## Contents

Safety Precautions .....	En-1
Indoor Unit Overview and Operations .....	En-3
Remote Controller Overview and Operations.....	En-4
Timer Operation.....	En-6
Human Sensor (Energy Saving).....	En-8
Demand Response and Indoor Unit Operation .....	En-8
General Informations on Operation .....	En-9
Care and Cleaning.....	En-10
Troubleshooting.....	En-12

## Safety Precautions

To prevent personal injury, injury to others, or property damage, read this section carefully before you use this product, and be sure to comply to the following safety precautions.

Incorrect operation due to failure to follow the instructions may cause harm or damage, the seriousness of which is classified as follows:



### WARNING

This mark warns of death or serious injury.



This mark denotes an action that is PROHIBITED.



### CAUTION

This mark warns of injury or damage to property.



This mark denotes an action that is COMPULSORY.

• Explanation of symbols displayed on the indoor unit or outdoor unit.

	<b>WARNING</b>	This symbol shows that this appliance uses a flammable refrigerant. If the refrigerant is leaked and exposure to an external ignition source, there is a risk of fire.
	<b>CAUTION</b>	This symbol shows that the Operation Manual should be read carefully.
	<b>CAUTION</b>	This symbol shows that a service personnel should be handling this equipment with reference to the Installation Manual.
	<b>CAUTION</b>	This symbol shows that information is available such as the Operating Manual or Installation Manual.



### WARNING



- The appliance shall be installed, operated and stored in a room with a floor area larger than 2.06m<sup>2</sup>.
- The appliance contains no user-serviceable parts. Always consult authorized service personnel for repairing, installation, and relocation of this product. Improper installation or handling will cause leakage, electric shock, or fire.
- In the event of a malfunction such as burning smell, immediately stop operation of the air conditioner, and disconnect all the power supply by turning off the electrical breaker or disconnecting the power plug. Then consult authorized service personnel.
- Take care not to damage the power supply cable. If it is damaged, it should only be replaced by authorized service personnel.
- In the event of refrigerant leakage, be sure to keep away from fire or any flammables, and consult authorized service personnel.
- If you see lightning or hear thunder, there might be a lightning strike. To prevent electric shock hazard, turn off the air conditioner by using the remote controller, and do not touch the unit or the power plug during thunderstorm.



- The appliance shall be stored in a room without continuously operating ignition sources (for example: open flames, an operating gas appliance or an operating electric heater).
- The appliance shall be stored in a well-ventilated area.
- Be aware that refrigerants may not contain an odour.
- The appliance shall be stored so as to prevent mechanical damage from occurring.
- Disposing of the product shall be done properly, in compliance with national or regional regulations.
- During transportation or relocation of the indoor unit, pipes shall be covered with the wall hook bracket for protection. Do not move the appliance by holding the indoor unit pipes. (The stress applied to the pipe joints may cause the flammable gas to leak during operation).
- This appliance is not intended for use by persons (including children) with reduced physical, sensory or mental capabilities, or lack of experience and knowledge, unless they have been given supervision or instruction concerning use of the appliance by a person responsible for their safety.
- Children should be supervised to ensure that they do not play with the appliance.

(continued)

## Safety Precautions (continued)

### ! WARNING

- ⊘ Do not install the unit in area filled with mineral oil such as a factory or area containing a large amount of splashed oil or steam such as a kitchen.
- ⊘ Do not start or stop the operation of this product by inserting or pulling out the power plug, or by turning on or off the circuit breaker.
- ⊘ Do not use inflammable gases near the unit.
- ⊘ Do not expose yourself directly to the cooling airflow for many hours.
- ⊘ Do not insert your fingers or any other objects into outlet port, open panel, or intake grille.
- ⊘ Do not operate with wet hands.
- ⊘ Do not use means to accelerate the defrosting process or to clean the appliance, other than those recommended by the manufacturer.
- ⊘ Do not pierce or burn.

### ! CAUTION

- ! Provide occasional ventilation during use.
- ! Always operate the unit with air filters installed.
- ! Ensure that any electronic equipment is at least 1 meter away from either the indoor unit or outdoor unit.
- ! Unplug the power supply cable when not using the indoor unit for an extended period.
- ! After long period of use, check whether the installation stand does not deteriorate to prevent the unit from falling down.
- ! The airflow direction and the room temperature should be carefully considered when you use this product in a room with infants, children, elderly or sick persons.
- ⊘ Do not direct the airflow at fireplaces or heating apparatus.
- ⊘ Do not block or cover the intake grille and the outlet port.
- ⊘ Do not apply any heavy pressure to radiator fins.
- ⊘ Do not climb on, place objects on, or hang objects from the unit.
- ⊘ Do not place vase or water container on the unit.
- ⊘ Do not place any other electrical products or household belongings under indoor unit or outdoor unit.  
Dripping condensation from the unit might get them wet, and may cause damage or malfunction of your property.
- ⊘ Do not expose the unit directly to water.
- ⊘ Do not use this product for preservation of food, plants, animals, precision equipment, art work, or other objects. This may cause quality deterioration of those items.
- ⊘ Do not expose animals or plants to the direct airflow.
- ⊘ Do not drink the drainage from the air conditioner.
- ⊘ Do not pull the power supply cable to disconnect the plug.
- ⊘ Do not touch the aluminum fins of heat exchanger built-in the indoor or outdoor unit to avoid personal injury when you install or maintain the unit.

#### Indoor unit accessories

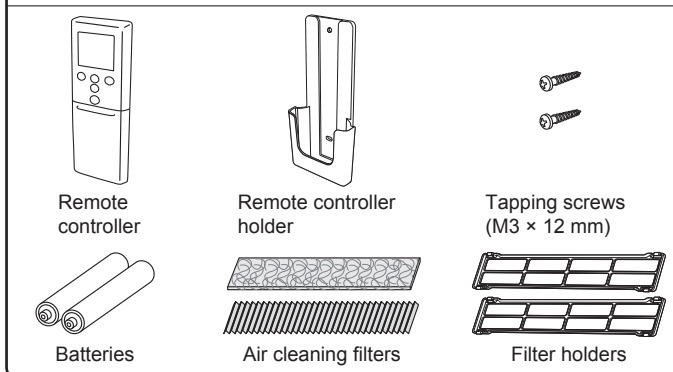

#### Remote controller holder installation

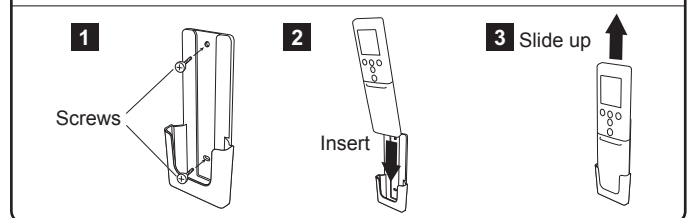

### ! WARNING

- ! Take care to prevent infants and young children from accidentally swallowing the batteries.

### ! CAUTION

- ⊘ Do not attempt to recharge dry batteries.
- ⊘ Do not use dry batteries that has been recharged.

#### Battery (R03/LR03/AAA × 2) loading and remote controller preparation

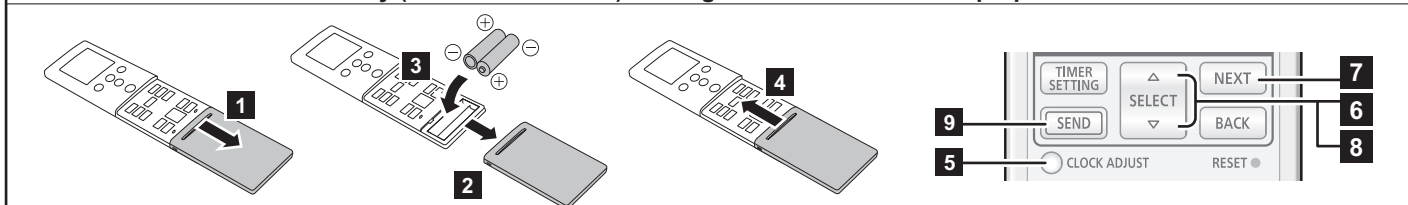

- 5 Press CLOCK ADJUST button to start clock setting.
- 6 Set the day of the week by pressing SELECT button (Monday to Sunday). \*By pressing the TEMP. (△▽) buttons, the time indicator can be changed from a 24-hour to a 12-hour clock.
- 7 Press NEXT button to continue.
- 8 Set the time by pressing SELECT button.  
Pressing △ or ▽ changes the value by the minute.  
Pressing down on △ or ▽ changes the value by 10 minutes.

- 9 To complete, press the SEND button close to the indoor unit. Settings may not be properly sent if pressed from a distance.

#### Notes:

- ⊘ Use specified type of batteries only.
- ⊘ Do not mix different types or new and used batteries together.
- ⊘ Batteries can be used about 1 year in ordinary use.
- ⊘ If the remote control range noticeably shortens, replace the batteries, and press RESET button as shown in page 5.

# Indoor Unit Overview and Operations

## 1 Intake grille

Before starting operation, make sure that the intake grille has been shut completely. Incomplete closing may have an effect on the proper function or performance of the product.

## 2 MANUAL AUTO button

Use when the remote controller is lost or there is a malfunction.

Status	Action	Mode or operation
In operation	Press more than 3 seconds.	Stop
Stopping	Press more than 3 seconds and less than 10 seconds.	AUTO
	Press more than 10 seconds. (Only for servicing.*)	Forced cooling
After cleaning	Press less than 3 seconds.	Filter indicator reset

\*:To stop forced cooling, press this button or START/STOP button on the remote controller.

## 3 Front panel

## 4 Human Sensor

See page 8

Used for Energy Saving Program. Controls temperature setting by detecting people in the room.

## 5 Vertical airflow direction louver

Each time you press Vertical SET button on the remote controller, the angle of the vertical airflow direction louver moves as follows:

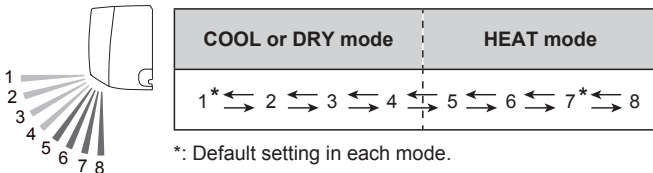

- Do not adjust by hand.
- At the beginning of AUTO or HEAT mode, they may stay on position 1 for a while for adjustment.
- If the angle is set to position 5-8 for more than 30 minutes in COOL or DRY mode, the louver will automatically return to position 4.
- Keeping the position 5-8 during COOL or DRY mode may cause condensation to form, and the drops may damage your property.

## 6 Power diffuser

In conjunction with movement of the vertical airflow direction louver, the angle of the power diffuser moves as follows:

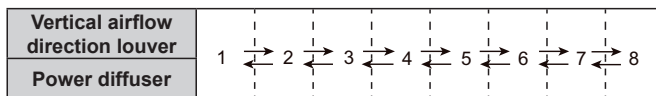

- In SWING operation, power diffuser does not move.

## 7 Horizontal airflow direction louver

Each time you press the Horizontal SET button on the remote controller, the airflow direction range of the horizontal airflow direction louver will change as follows:

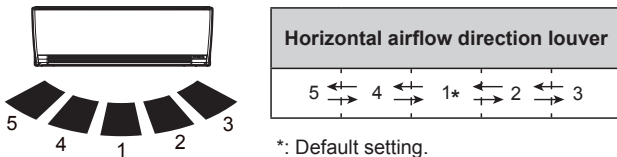

## 8 Drain hose

## 9 Remote controller signal receiver

### CAUTION

- ! For appropriate signal transmission between remote controller and indoor unit, keep the signal receiver away from the following items:
  - Direct sunlight or other strong lights
  - Flat-panel television screen

In rooms with instantaneous fluorescent lights, such as inverter type ones, the signal may not be transmitted properly. In such a case, consult the store of purchase.

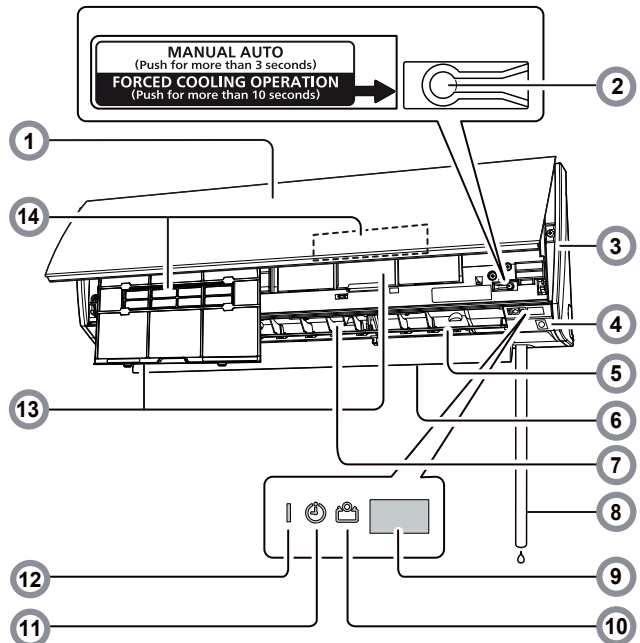

## 10 ECONOMY indicator (green)

Lights in ECONOMY operation and in 10 °C HEAT operation.

## 11 TIMER indicator (orange)

Lights in TIMER operation, and blinks slowly when the timer setting error is detected. For details, refer to "Auto-restart function" on page 9.

## 12 OPERATION indicator (green)

Lights in normal operation, and blinks slowly in Automatic defrosting operation. Blinks during Demand Response operation. For details, refer to page 8.

## 13 Air filter

See page 10

## 14 Air cleaning filters

See page 11

Purify or deodorize the air, and provide fresh airflow.

# Remote Controller Overview and Operations

## CAUTION

- ! To prevent malfunction or damage of the remote controller:
  - Place remote controller at where will not be exposed to direct sunlight or excessive heat.
  - Remove batteries if the product is not going to be used for an extended period.
  - Exhausted batteries must be removed immediately, and be disposed according to the local laws and regulations of your region.
- ! If leaking battery fluid comes in contact with your skin, eyes, or mouth, immediately rinse with plenty of clean water, and consult your physician.
- ! Obstacles such as a curtain or wall between the remote controller and the indoor unit may affect the appropriate signal transmission.
- ⊘ Do not apply strong shocks to the remote controller.
- ⊘ Do not pour water on the remote controller.

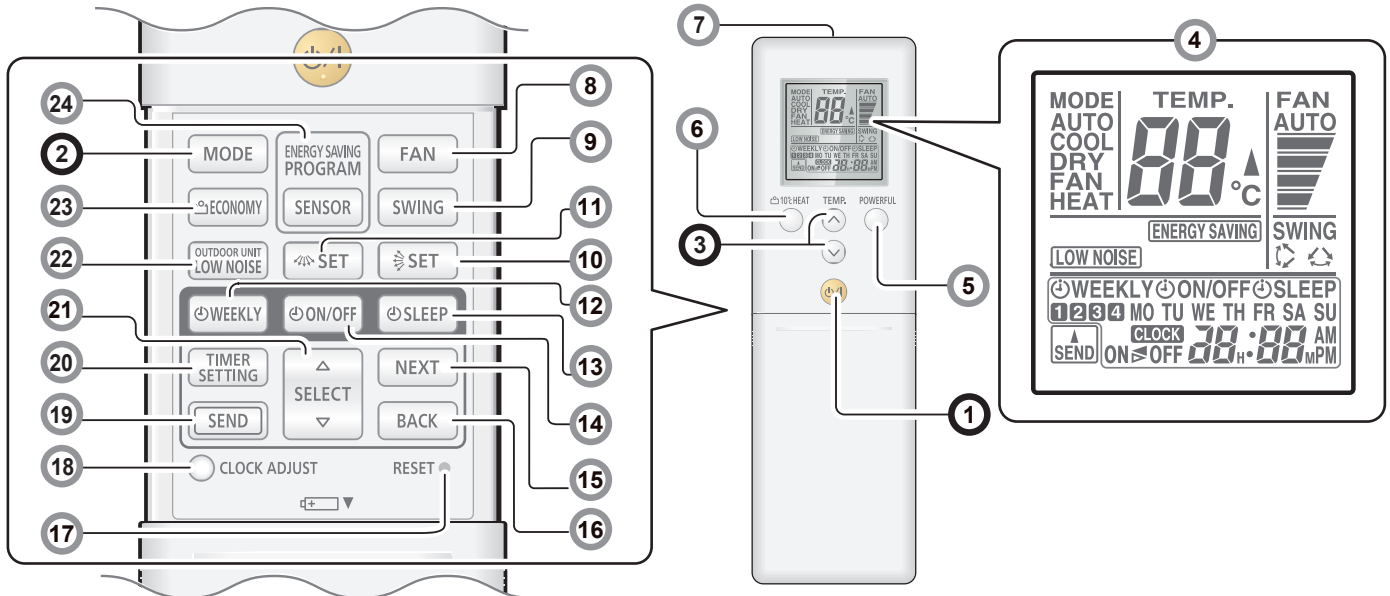

You can quickly start operation with the following 3 steps:

### 1 START/STOP button

### 2 MODE button

Switches operation mode in following order.



#### Notes in HEAT mode:

- At the beginning of the operation, the indoor unit operates at very low fan speed for about 3–5 minutes for preparation, then switches to the selected fan speed.
- Automatic defrosting operation overrides the heating operation when necessary.

### 3 TEMP. (temperature) buttons

Sets the desired temperature.

In COOL or DRY mode, the temperature needs to be set lower than the current room temperature. In HEAT mode, the temperature needs to be set higher than the current room temperature. Otherwise, corresponding operation mode may not start.

Temperature setting range	
AUTO/COOL/DRY	18–30 °C
HEAT	16–30 °C

**Notes:** Temperature control is not available in FAN mode.

### 4 Remote controller display

In this section, all the possible indicators are displayed for description. In actual operation, the display is linked with the button operation, and only shows the necessary indicators for each setting.

### 5 POWERFUL button

Activates the POWERFUL operation.

The unit will operate at maximum power and strong airflow to quickly cool down or warm up the room.

When activated, the indoor unit will emit 3 short beeps.

To turn off, press the POWERFUL button again. The indoor unit will then emit 2 short beeps.

POWERFUL operation is automatically turned off in the following situations:

- Adjusted room temperature reaches the set temperature in COOL, DRY, or HEAT mode.
- 20 minutes have passed after the POWERFUL operation mode has been set.

Even in situations above, the POWERFUL operation will not automatically turn off unless it has run for a certain amount of time.

#### Notes:

- The airflow direction and the fan speed are controlled automatically.
- This operation cannot be performed simultaneously with ECONOMY operation.
- POWERFUL operation will override the OUTDOOR UNIT LOW NOISE, ENERGY SAVING functions. Both functions, if set, will start after the POWERFUL operation is turned off.

### 6 10 °C HEAT button

Starts 10 °C HEAT operation that maintains the room temperature at 10 °C so as to prevent the room temperature to drop too low.

After pressing the button to start the 10 °C HEAT operation, the indoor unit emits 2 short beeps and the ECONOMY indicator (green) will turn on.

To turn off, press the START/STOP button. The Economy indicator will turn off.

#### Notes:

- In 10 °C HEAT operation mode, only the vertical airflow direction can be adjusted by using the SET button.
- HEAT mode will not be performed if the room temperature is warm enough.

(continued)

## Remote Controller Overview and Operations (continued)

### 7 Signal transmitter

Aim at the signal receiver of the indoor unit properly.

- Signal transmit indicator ▲ on the remote controller display shows that the signal from the remote controller is being transmitted.
- Operating range is approximately 7 m.
- You will hear a beep if the transmitted signal has been sent properly. If there is no beep, press the button on the remote controller again.

### 8 FAN button

Controls the fan speed.



- When AUTO is selected, the fan speed is automatically adjusted according to the operation mode.

### 9 SWING button

Sets the automatic swing operation. Each time the SWING button is pressed, the operation will change.

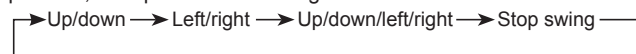

- The Left/right swing operation will follow the direction as shown on page 3 "Horizontal airflow direction louver"
- The Up/down Swing operation range will differ by mode as follows:

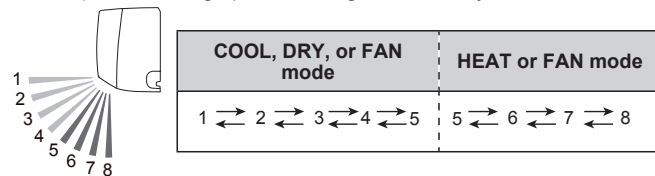

Notes:

- SWING operation may stop temporarily when the indoor unit fan is rotating at very low speed or is stopped.
- In FAN mode, the Up/down swing operation range of 1 ↔ 5 or 6 ↔ 8 is decided according to the airflow direction previously set before starting the swing operation.

### 10 Vertical SET button

Adjusts the vertical airflow direction.

### 11 Horizontal SET button

Adjusts the horizontal airflow direction.

### 12 WEEKLY timer button

Activates the WEEKLY timer for a maximum of 4 on or off programs per day, each day of the week.

### 13 SLEEP timer button

Activates the SLEEP timer that helps you to fall asleep comfortably with gradual temperature control.

### 14 ON/OFF timer button

Activates the ON/OFF timer.

### 15 NEXT button

Used for adjusting the timer setting.

### 16 BACK button

Used for adjusting the timer setting.

### 17 RESET button

When you press the RESET button, press it gently by using the tip of a ballpoint pen or other small object in correct direction as shown in this figure.



### 18 CLOCK ADJUST button

See page 2

Used for adjusting the clock.

### 19 SEND button

Used for sending the timer/clock setting.

### 20 TIMER SETTING button

See page 6

Used to enter the timer setting mode.

### 21 SELECT button

Used for adjusting the clock or timer.

### 22 OUTDOOR UNIT LOW NOISE button

Starts or stops OUTDOOR UNIT LOW NOISE operation that lowers noise generated from the outdoor unit by cutting down the rotation number of the compressor, and suppressing the fan speed.

Once the operation is set, the setting is preserved until you press this button again to stop the operation, even if the indoor unit operation is stopped.

**LOW NOISE** on the remote controller display shows that the unit is in OUTDOOR UNIT LOW NOISE mode.

Notes:

- This operation cannot be performed simultaneously with FAN, DRY and POWERFUL operation modes.

### 23 ECONOMY button

Starts or stops ECONOMY operation that saves more electricity than other operation modes by changing the set temperature to a moderate setting.

By pressing the ECONOMY button, the ECONOMY indicator on the indoor unit turns on.

- In COOL or DRY mode, the room temperature will be adjusted a few degrees higher than the set temperature.
- In HEAT mode, the room temperature will be adjusted a few degrees lower than the set temperature.

Notes:

- In COOL, HEAT, or DRY mode, the maximum output of this operation is approximately 70 % of usual air conditioning operation.
- This operation cannot be performed during temperature monitoring by AUTO mode.

### 24 SENSOR button (ENERGY SAVING PROGRAM)

See page 8

Activates or deactivates the energy saving program.

\* The Energy Saving program is ON at the time of purchase.

\*: The setting must be done while the setting screen is displayed for each function.

! : The button is controllable only when the air conditioner is on.

# Timer Operation

## Note for timer settings:

Any interruption of the power supply, such as a blackout or cutting off of a circuit breaker, makes the set internal clock go wrong. In such a case, the TIMER indicator on the indoor unit blinks, and you need to readjust the setting.

## ON timer or OFF timer

You can set the ON timer or OFF timer with the following steps.

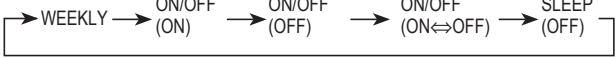
- ① Press the TIMER SETTING button to start the setting. The WEEKLY indicator will be flashing on the remote controller.
- ② Press the SELECT button to choose the desired mode. The mode will change as follows:  

- ③ Press the NEXT button. Continue to setting for each mode.  
 \* To cancel timer setting during the setting process, press the TIMER SETTING button again.
- ④ Adjust the time by pressing the SELECT button while the clock indicator is blinking. Each time you press the button, the time will change by +5/-5 minutes. Pressing down will change the time by +10/-10 minutes.
- ⑤ Press the SEND button.

To redo the timer setting, perform step 1 to 5 again.

To cancel the ON/OFF timer, press the ON/OFF button while the ON/OFF indicator is on. (Erases the indicator)

## Program timer (combined use of the ON timer and the OFF timer)

You can set an integrated ON-OFF or OFF-ON timer. Either of the timer whose configured starting time is closer to the current time works first, and the order of timer operation is displayed as follows:

Timer	Indicator on remote controller display
ON-OFF timer	ON▷OFF
OFF-ON timer	ON◁OFF

To set the program timer, conduct the same steps ①~⑤ for the ON/OFF timer. (Select ON↔OFF in Step 2)

### Notes:

- If you change the setting value for the timer after the program timer is set, the counting down of the timer will be reset at that moment.
- Time setting for each combination should be within a span of 24 hours.

## SLEEP timer

To set the SLEEP timer, first follow steps ①~③ for the ON/OFF timer.

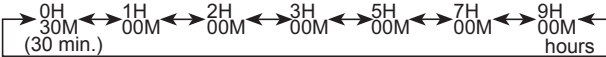
- ④ Adjust the time by pressing the SELECT button while the clock indicator is blinking. Each time you press the button, the time changes as follows:  

- ⑤ Press the SEND button.

To cancel the SLEEP timer, press the SLEEP button while the SLEEP indicator is on. (Erases the indicator)

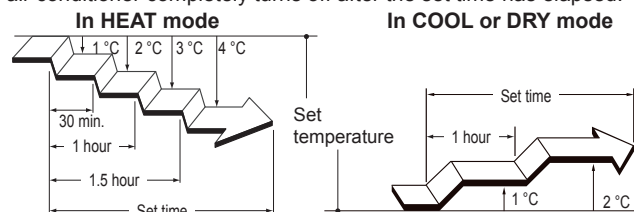
To help you to fall asleep comfortably and prevent excessive warming or cooling in sleep, the SLEEP timer controls the temperature setting automatically in accordance with the set time shown as follows. The air conditioner completely turns off after the set time has elapsed.



## WEEKLY timer

ON and OFF timer can be combined, and up to 4 reservations (program 1~4) per day and 28 reservations per week.

Before setting the program, please set the week and time of the air conditioner first.

If the week and time are not set, the weekly timer will not operate correctly at the set time.

Please refer to "remote controller preparation" (page 2).

### Example of WEEKLY timer 1

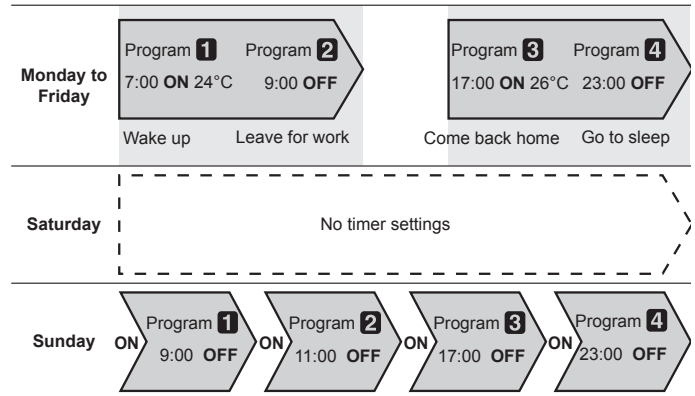

### Example of WEEKLY timer 2

You can specify a given temperature in the ON setting in WEEKLY timer.

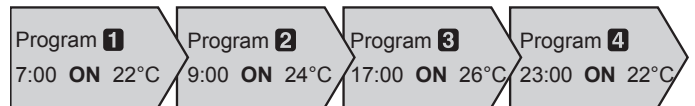

\* You can set the temperature for AUTO, COOL, and DRY modes within the range of 18-30°C, for Heat mode the range is 10 or 16-30°C.

Even if you set to 10, 16, or 17°C, if you run the product on AUTO, COOL, or DRY, it will run at 18°C.

### Notes:

- Operations modes other than the temperature setting will be the same at the last time operation was stopped, so Cooling → Heating → Cooling → Heating type of operations cannot be automatically set.
- If you set the ON timer and OFF timer on the same time, the air conditioner will run the ON timer. If two ON timer are set at the same time, the air conditioner will run in the order of the program number.
- If there is a power interruption, such as due to a power outage during the WEEKLY timer setting or a circuit breaker cutting out, the internal timer of the air-conditioning will be incorrect. (See page 9 "Auto-restart".) In such a case, the main timer lamp will notify you of this by flashing, so carry out matching of the time and date. (See page 3 "remote controller preparation".)
- You cannot use the WEEKLY timer together with the other timers. If you want to run the product on WEEKLY timer after using the ON/OFF Timer, Program Timer, or SLEEP Timer while the WEEKLY timer is running, you need to activate the WEEKLY timer again.

(continued)

## Timer Operation (continued)

To set the WEEKLY timer, first follow steps ①~③ on page 6 for the ON/OFF timer.

- ④ Select the program number and the day using the SELECT button.

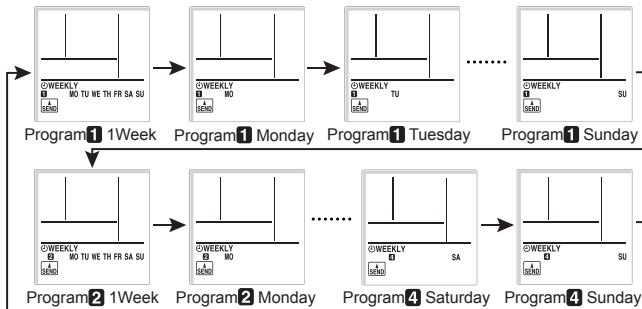

Press the NEXT button, when the program number and day you want to set are flashing.

- ⑤ Using the SELECT button select the operation mode (ON timer, OFF timer, or without a timer).

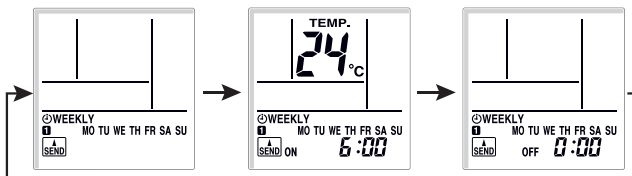

To operate without a timer —

1. Press the NEXT button to go back to step 4 and configure the next setting.
2. Press the SEND button to finish

Press the NEXT button.

- ⑥ Press the SELECT button to set the desired ON time or OFF time.

If you selected OFF in step 5 —

1. Press the NEXT button to go back to step 4 and configure the next setting.
2. Press the SEND button.

Press the NEXT button.

- ⑦ Press the SELECT button to set the temperature.  
If you want to move on to the next setting, press the NEXT button, return to step 4 and configure the next setting.

- ⑧ To complete the setting, press the SEND button.

If you want to cancel the setting midway, please press the TIMER SETTING button instead of pressing the SEND button.

### Notes:

- When canceling the WEEKLY timer, select No Timer Operation in Step 5 in the WEEKLY timer setting.
- If you want to go back to the previous step when configuring settings, press the BACK button to return to the previous step.
- Press the SEND button, when you are close to the main unit. If you do so when far from the main unit, the signal may not get properly sent, and the settings may not get properly configured.
- To check the schedule, repeat steps 1 to 3 to enter the WEEKLY timer mode, then use the SELECT button to browse through the WEEKLY timer settings in the order shown in step 4.
- To cancel the WEEKLY timer, press the WEEKLY button while the WEEKLY indicator is on. (Erases the indicator)



## General Informations on Operation

### Automatic defrosting operation

When outdoor temperature is very low with high humidity, frost may form on the outdoor unit during the heating operation, and it could reduce the operating performance of the product.

For frost protection, a microcomputer-controlled automatic defrost function is equipped in this air conditioner.

If frost forms, the air conditioner will temporarily stop, and defrost circuit will operate briefly (maximum of 15 minutes.)

OPERATION indicator on the indoor unit blinks during this operation.

If frost forms on the outdoor unit after the heating operation, the outdoor unit will stop automatically after it operates for a few minutes. Then the automatic defrosting operation starts.

### Heating performance

This air conditioner operates on the heat-pump principle, absorbing heat from air outdoors and transferring that heat to the indoor unit. As a result, the operating performance is reduced as outdoor air temperature drops. If you feel that the heating performance is insufficient, we recommend you to use this air conditioner in conjunction with other kinds of heating appliance.

### Auto-restart function

In event of power interruption such as a blackout, the air conditioner stops once. But it restarts automatically and performs previous operation when the power supply is resumed.

If any power interruption occurs after the timer is set, counting down of the timer will be reset.

After the power supply is resumed, the TIMER indicator on the indoor unit blinks to notify you that there has been a timer fault.

In such a case, reset the timer for your opportune time.

### Malfunctions caused by other electrical devices:

Use of other electrical appliances such as an electric shaver or nearby use of a wireless radio transmitter may cause the malfunction of the air conditioner.

If you encounter such a malfunction, turn off the circuit breaker once. Then turn it on again, and resume operation by using the remote controller.

## Temperature and Humidity Range

Permissible ranges of temperature and humidity are as follows:

COOL/DRY	Indoor temperature	About 18 °C to 32 °C
	Indoor humidity	Below approximately 80%. If the air conditioner is used continuously for many hours, water may condense on the surface and drip.
HEAT	Indoor temperature	About 16 °C to 30 °C

If the unit is used under higher temperature conditions than those noted here, the automatic protection circuit may operate, interrupting the operation. If the unit is used under lower temperature conditions than those noted here, the heat exchanger may freeze, causing water leakage or other malfunction.

- Do not use the air conditioner for any purpose other than room cooling/dry, room heating or fan.

# Care and Cleaning

## ⚠ CAUTION

- ❗ Before cleaning the indoor unit, be sure to turn it off and all the power supply has been disconnected.
- ❗ Before starting operation, make sure that the intake grille has been shut completely. Incomplete closing of the intake grille might have an effect on the proper working or performance of the air conditioner.
- ⊘ Do not touch the aluminum fins of heat exchanger built-in the indoor unit to avoid personal injury when you maintain the unit.
- ⊘ Do not expose the indoor unit to liquid insecticides or hair sprays.
- ⊘ Do not stand on slippery, uneven or unstable surfaces when you maintain the unit.

### Daily care

When cleaning the indoor unit body, mind the following:

- Do not use water hotter than 40 °C.
- Do not use scouring cleanser, volatile solvents such as benzene or thinner.
- Wipe the unit gently by using soft cloth.

### Cleaning the intake grille

- 1 Open the intake grille in direction of the arrow **a**. While gently pressing the left and right mounting shafts of the intake grille outward **b**, remove the intake grille in direction of the arrow **c**.

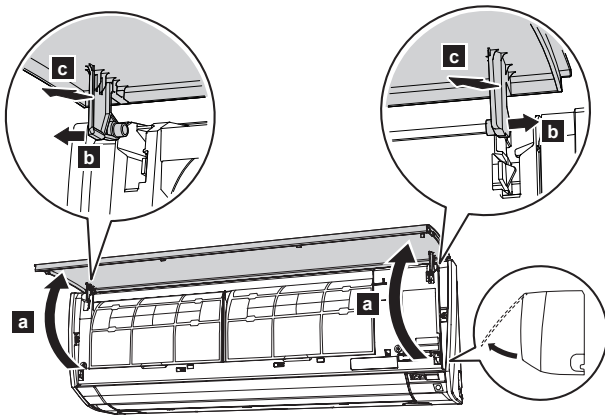

- 2 Wash the intake grille gently with water or wipe it gently with a soft cloth moisten with warm water. Then wipe it with a dry and soft cloth.
- 3 While holding the grille horizontal, set the left and right mounting shafts into the pillow blocks at the top of the panel **a**. To latch each shaft properly, insert the shaft until it snaps. Then close the intake grille **b**.

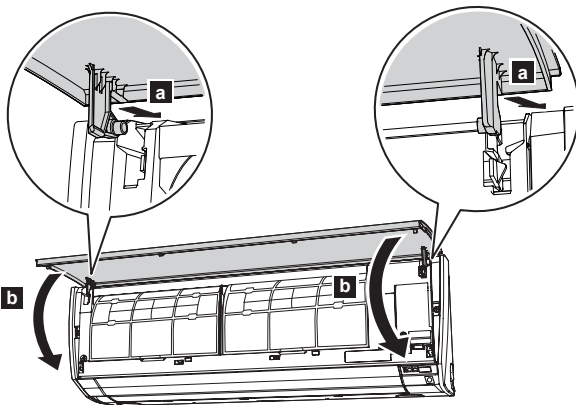

- 4 Press 4 places on the intake grille to close it completely.

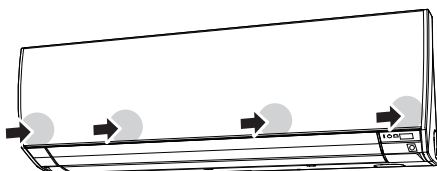

### Cleaning the air filters

Mind that you have a periodical cleaning of the air filters to prevent reducing the operation efficiency of the product.

Using of clogged air filter with dust will lower the product performance, and may cause airflow reduction or increase of operating noise.

Clean the air filters once every 2 weeks under normal use.

- 1 Open the intake grille. (Refer to **a** of step 1 in “Cleaning the intake grille”.)
- 2 While holding the intake grille with your hand, pull up the handle **a** of the filter in direction of the arrow and release the 2 claws **b**. Then pull the filter out with gently sliding it downward **c**.

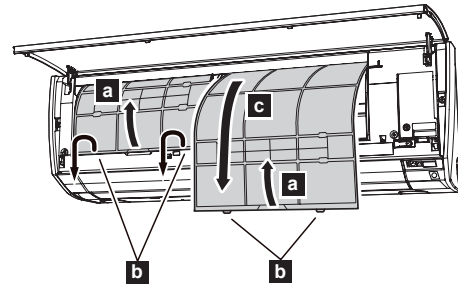

- 3 Filter holder and air cleaning filter are attached on the rear side of the air filter. Remove them from the air filter by unlatching each corner of the filter holder **d**.

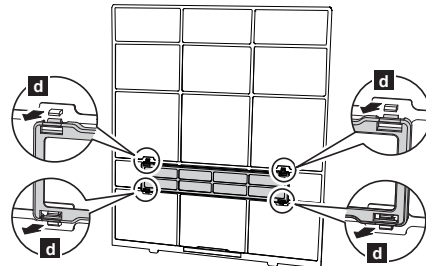

- 4 Remove dust by using a vacuum cleaner or by washing the filter. When you wash the filter, use neutral household detergent and warm water. After rinse the filter well, dry it thoroughly in a shaded place before you reinstall it.
- 5 Attach the air cleaning filter and the filter holder to each air filter.
- 6 Attach the air filter with aligning both side of the filter with the front panel, and push in the filter fully.

#### Note:

Make sure that 2 claws are firmly snapped to the guide holes on the panel.

- 7 Close the intake grille firmly. (Refer to step 4 in “Cleaning the intake grille”.)

## Care and Cleaning

### Replacing the air cleaning filter

- ① Remove the air filter. (Refer to step 1 in "Replacing the air filter".)
- ② Release 2 latches **a** of the filter holder, and turn over the holder in direction of arrow **b**.  
Remove the soiled air cleaning filter **c**.

**Note:**

Air cleaning filter is attached on each air filter.

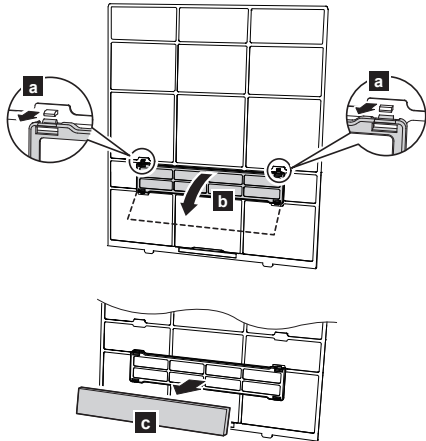

- ③ Attach new or maintained air cleaning filter **d** to the filter holder. New air cleaning filter can be attached to either of the right holder or the left holder.

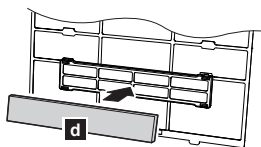

- ④ Latch 2 corners of the filter holder **e** to the air filter firmly.

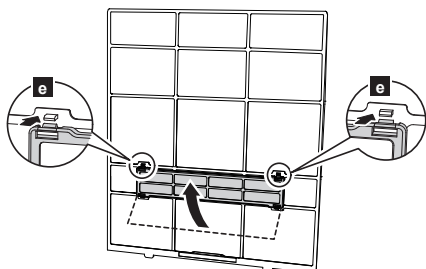

- ⑤ Reinstall the air filter. (Refer to step 6 in "Cleaning the air filter".)
- ⑥ Close the intake grille firmly. (Refer to step 4 in "Cleaning the intake grille" on page 10.)

Following 2 types of air cleaning filters are used in this product. When you replace them, purchase dedicated air cleaning filters for this product.

#### Apple-catechin filter: UTR-FA16



(1 sheet)

The Apple-catechin filter uses static electricity to clean fine particles and dust in the air such as tobacco smoke and plant pollen that are too small to see.

- This filter is disposable. Do not wash or reuse it.
- Once you open the package, use it as soon as possible. The cleaning effect is reduced if the filter is left with the package opened.
- Replace the filter once every 3 months under normal use.
- By setting the fan speed high, the air cleaning effect increases.

#### Ion deodorization filter: UTR-FA16-2

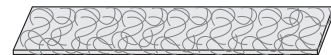

(Light blue, 1 sheet)

The filter deodorizes by powerfully decomposing absorbed odors using the oxidizing and reducing effects of ions generated by the ultra-fine-particle ceramic.

- To maintain the deodorizing effect, clean the filter once every 3 months as follows:
  1. Remove the filter.
  2. Flush the filter with high-pressure hot water until the surface of the filter is covered with water.
  3. Wash the filter gently with diluent neutral detergent. Do not wash it by wringing or rubbing to prevent reducing the deodorizing effect by damage.
  4. Rinse the filter well with water flow.
  5. Dry the filter thoroughly in a shaded place.
  6. Reinstall the filter to the indoor unit.
- Replace the filter once every 3 years under normal use.

#### After extended non-use of the unit

If you have shut down the indoor unit for 1 month or more, perform the FAN operation for half a day to dry the internal parts thoroughly before you perform normal operation.

#### Additional inspection

After long period of use, accumulated dust inside the indoor unit may reduce the product performance even if you have maintained the unit with instructed daily care or cleaning procedures written in this manual.

In such a case, a product inspection is recommended.

For more information, consult authorized service personnel.

# Troubleshooting

## ⚠ WARNING



In following events, immediately stop operation of the air conditioner, and disconnect all the power supply by turning off the electrical breaker or disconnecting the power plug. Then consult your dealer or authorized service personnel.  
 As long as the unit is connected to the power supply, it is not insulated from the power supply even if the unit is turned off.

- Unit smells of something burning or emits smoke
- Water leaks from the unit

Following symptoms do not indicate product malfunction, but they are normal functions or characteristics of this product.

Symptom	Cause	See page
Operation is delayed after restart.	To prevent blowout of the fuse, the compressor will not operate while the protection circuit is working for about 3 minutes after sudden OFF→ON operation of the power supply.	–
Noise is heard.	<ul style="list-style-type: none"> <li>• During operation or immediately after stopping the air conditioner, refrigerant flowing sound may be heard. Also it may be particularly noticeable for 2–3 minutes after starting operation.</li> <li>• During the operation, a slight squeaking sound produced by the minute expansion and contraction of the front panel caused by temperature change may be heard.</li> </ul>	–
	During heating operation, a sizzling sound produced by the automatic defrosting operation may be heard.	9
Smell coming from the unit.	Various smells generated from interior textile, furniture, or cigarette smoke absorbed into the air conditioner may be emitted.	–
Mist or steam is emitted from the unit.	In COOL or DRY mode, a thin mist generated by condensation formed with sudden cooling process may be emitted.	–
	During heating operation, the fan built-in the outdoor unit may stop and rising steam generated by the automatic defrosting operation may be seen.	9
Airflow is weak or stops.	<ul style="list-style-type: none"> <li>• Immediately after the heating operation is started, the fan speed stays very low temporarily to warm up the internal parts of the unit.</li> <li>• In HEAT mode, the outdoor unit stops and the indoor unit operates at very low fan speed if the room temperature rises above the set temperature.</li> </ul>	–
	In HEAT mode, the indoor unit temporarily stops for maximum of 15 minutes to perform the automatic defrosting operation while the OPERATION indicator is flashing.	9
	In DRY mode, the indoor unit operates at low fan speed to adjust the room humidity, and may stop from time to time.	–
	When the fan speed is set to “QUIET”, the fan rotates at very low speed and the airflow is reduced.	–
	In COOL mode, the indoor unit fan may stop from time to time when the outdoor unit is stopped.	4
	When monitoring operation is performed in AUTO mode, the fan rotates at very low speed.	–
Outdoor unit emits water.	During heating operation, the outdoor unit may emit water generated by the automatic defrosting operation.	9

Before you call for or request servicing, troubleshoot a problem by performing following checks:

Symptom	Diagnostic	See page
Does not operate at all.	<input type="checkbox"/> Has the circuit breaker been turned off? <input type="checkbox"/> Has there been a power outage? <input type="checkbox"/> Has a fuse blown out or the circuit breaker been tripped?	–
	<input type="checkbox"/> Is the timer operating?	6
Poor cooling or heating performance.	<input type="checkbox"/> Is the air filter dirty?	10
	<input type="checkbox"/> Is the intake grill or outlet port of indoor unit blocked?	–
	<input type="checkbox"/> Is the room temperature adjusted appropriately?	4
	<input type="checkbox"/> Is a window or door left opened? <input type="checkbox"/> Is direct or strong sunlight shinning into the room in cooling operation? <input type="checkbox"/> Are there other heating apparatus or computers operating, or too many people in the room in cooling operation?	–
	<input type="checkbox"/> Is the fan speed set to “QUIET”? When the fan speed setting is set to “QUIET”, noise reduction is prioritized and the air-conditioning performance may become lower. If the volume of provided airflow is not agreeable to your preference, set the fan speed to “LOW” or higher fan speed.	5
	<input type="checkbox"/> Has the OUTDOOR UNIT LOW NOISE mode been set?	5
	<input type="checkbox"/> Do you have an arrangement with your electric company for Demand Response?	8
The unit operates differently from the remote controller setting.	<input type="checkbox"/> Are the batteries used in the remote controller exhausted? <input type="checkbox"/> Are the batteries used in the remote controller loaded properly?	2

Immediately stop operation and turn off the electrical breaker in following cases. Then consult authorized service personnel.

- The problem persists even if you perform these checks or diagnostics.
- The OPERATION indicator and TIMER indicator blink while the ECONOMY indicator is blinking fast.