



Microwave Hood Combination

Use & Care Guide

Combinación Microondas Campana

Guía de uso y cuidado

Models/Modelos 721.80822
 721.80823
 721.80824
 721.80829

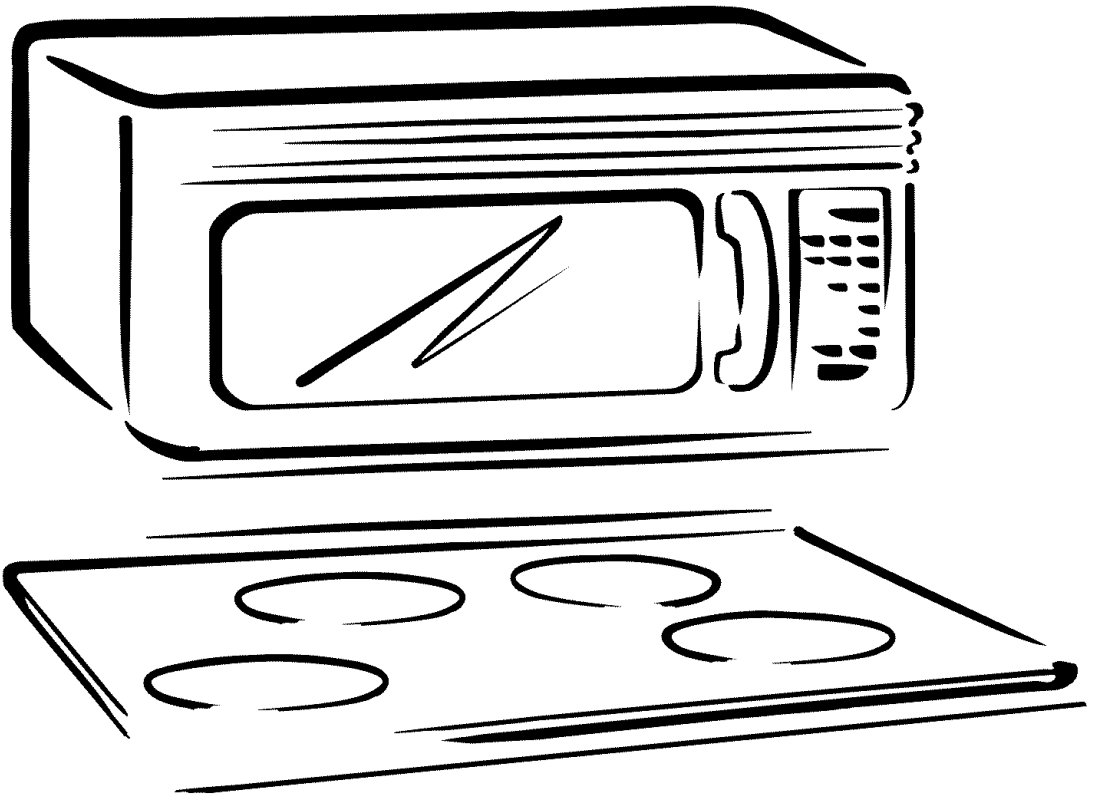

ENGLISH

ESPAÑOL

Table of Contents

Warranty.....	2
Microwave Oven Safety	3~5
Getting To Know Your Microwave Oven	6~10
How your kenmore microwave hood combination works	6
Radio interference	6
Testing your microwave oven.....	6
Testing your dinnerware or cookware	7
Operating safety precautions.....	7
Electrical connection	7
Specifications.....	8
Microwave oven features	8
Control panel features	9~10
Microwave Cooking Tips.....	11~12
Cooking Comparison Guide.....	13
Cookware Guide.....	14
How To Use Accessories.....	15
Using Your Microwave Oven	16~25
Audible Signals.....	16
Clock.....	16
Interrupting cooking.....	16
Child lock	16
Kitchen timer.....	16
Exhaust fan.....	17
Cooktop light.....	17
Light timer	17
Add 30 sec.....	18
Timed cooking.....	18
Two - stage cooking.....	18
Microwave power levels.....	19
Turntable on/off	20
Option.....	20
Favorite	20
Melt / Soften.....	21
Auto defrost.....	22~25
Using Sensor Cooking	26~39
Sensor operating instructions.....	26
Sensor cook guide	26
Sensor popcorn.....	26
Sensor cook / Sensor reheat.....	26
Sensor cook table / Sensor reheat table.....	27
Auto cook / Auto cook table.....	28
Tips for convection cooking.....	29
Convection.....	30
Convection baking guidelines	31~32
Meat roasting guidelines for convection cooking.....	33
Tips for combination cooking.....	34
Combination roast.....	34
Speed auto combination/Speed auto combination chart.....	35
Combination roast cooking guide	36~37
Combination bake cooking guide.....	37
Heation/Reheating guide	38
Fresh vegetable guide	39
Caring For Your Microwave Oven.....	40~42
Caring for the filters	41
Replacing the cooktop and oven lights	42
Questions And Answers.....	43
Troubleshooting.....	44~45
Master Protection Agreements	90
Service	Back cover

Microwave Hood Combination Warranty

FULL ONE-YEAR WARRANTY ON MICROWAVE HOOD COMBINATION

For one year from the date of purchase, if this Kenmore Microwave Hood Combination fails due to a defect in material or workmanship, Sears will repair it free of charge.

FOUR YEAR LIMITED WARRANTY ON MAGNETRON

For the second through the fifth year from the date of purchase, if the magnetron in this oven fails due to a defect in material or workmanship, Sears will supply a new magnetron, free of charge. Safety regulations, however, require the magnetron to be installed by Sears, and you must pay the labor cost of installation.

WARRANTY SERVICE IS AVAILABLE BY SIMPLY CONTACTING SEARS SERVICE AT 1-800-4-MY-HOME®

This warranty applies only while this product is in use in the United States.

This warranty gives you specific legal rights, and you may also have other rights which vary from state to state.

**Sears, Roebuck and Co.,
Dept. 817WA,
Hoffman Estates, IL 60179**

**For service call:
1-800-4-MY-HOME®
(1-800-469-4663)**

Please record your model's information.

Whenever you call to request service for your appliance, you need to know your complete model number and serial number. You can find this information on the model and serial number label/plate at the upper side of cavity front in your Microwave oven. Also, record the other information shown below.

Model Number _____

Serial Number _____

Purchase Date _____

Microwave Oven Safety

Your safety and the safety of others are very important.

We have provided many important safety messages in this manual and on your appliance. Always read and obey all safety messages.



This is the safety alert symbol.

This symbol alerts you to hazards that can kill or hurt you and others.

All safety messages will be preceded by the safety alert symbol and the word “DANGER” or “WARNING.” These words mean:

 **DANGER**

You will be killed or seriously injured if you don't follow instructions immediately.

 **WARNING**

You can be killed or seriously injured if you don't follow instructions.

All safety messages will identify the hazard, tell you how to reduce the chance of injury, and tell you what can happen if the instructions are not followed.

IMPORTANT SAFETY INSTRUCTIONS

When using electrical appliances basic safety precautions should be followed, including the following:

WARNING: To reduce the risk of burns, electric shock, fire, injury to persons, or exposure to excessive microwave energy:

- Read all instructions before using the microwave oven.
- Read and follow the specific “PRECAUTIONS TO AVOID POSSIBLE EXPOSURE TO EXCESSIVE MICROWAVE ENERGY” found in this section.
- The microwave oven must be grounded. Connect only to properly grounded outlet. See “GROUNDING INSTRUCTIONS” found at the end of this section.
- Install or locate the microwave oven only in accordance with the provided installation instructions.
- Some products such as whole eggs in the shell and sealed containers – for example, closed glass jars – are able to explode and should not be heated in the microwave oven.
- Use the microwave oven only for its intended use as described in this manual. Do not use corrosive chemicals or vapors in the microwave oven. This type of oven is specifically designed to heat, cook, or dry food. It is not designed for industrial or laboratory use.
- As with any appliance, close supervision is necessary when used by children.
- Do not operate the microwave oven if it has a damaged cord or plug, if it is not working properly, or if it has been damaged or dropped.

SAVE THESE INSTRUCTIONS

IMPORTANT SAFETY INSTRUCTIONS

- The microwave oven should be serviced only by qualified service personnel. Call an authorized service company for examination, repair, or adjustment.
- See door surface cleaning instructions in the “Caring for Your Microwave Oven” section.
- To reduce the risk of fire in the oven cavity:
 - Do not overcook food. Carefully attend the microwave oven when paper, plastic, or other combustible materials are placed inside the oven to facilitate cooking.
 - Remove wire twist-ties from paper or plastic bags before placing bags in oven.
 - If materials inside the oven ignite, keep oven door closed, turn oven off, and disconnect the power cord, or shut off power at the fuse or circuit breaker panel.
 - Do not use the cavity for storage purposes. Do not leave paper products, cooking utensils, or food in the cavity when not in use.
- This microwave oven is suitable for use above both gas and electric cooking equipment.
- This microwave oven is intended to be used above ranges with maximum width of 36 inches (91 cm).
- Clean Ventilating Hoods Frequently -Grease should not be allowed to accumulate on hood or filter.
- When flaming foods under the hood, turn the fan on.
- Use care when cleaning the vent-hood filter. Corrosive cleaning agents, such as lye-based oven cleaners, may damage the filter.
- Oversized foods or oversized metal utensils should not be inserted in the microwave oven as they may create a fire or risk of electric shock.
- Do not clean with metal scouring pads. Pieces can burn off the pad and touch electrical parts involving a risk of electric shock.
- Do not store anything directly on top of the microwave oven when the microwave oven is in operation.
- Do not cover or block any openings on the microwave oven.
- Do not store this microwave oven outdoors. Do not use the microwave oven near water - for example, near a kitchen sink, in a wet basement, near a swimming pool, or similar location.
- Do not immerse cord or plug in water.
- Keep cord away from heated surfaces.
- Do not let cord hang over edge of table or counter.
- Do not mount over a sink.
- Do not cover racks or any other part of the oven with metal foil. This will cause overheating of the oven.
- Liquids such as water, coffee, or tea are able to be overheated beyond the boiling point without appearing to be boiling due to surface tension of the liquid. Visible bubbling or boiling when the container is removed from the microwave oven is not always present. This could result in very hot liquids suddenly boiling over when a spoon or other utensil is inserted into the liquid. To reduce the risk of injury to persons;
 - 1) Do not overheat the liquid.
 - 2) Stir the liquid both before and halfway through heating it.
 - 3) Do not use straight-sided containers with narrow necks.
 - 4) After heating, allow the container to stand in the microwave oven for a short time before removing the container.
 - 5) Use extreme care when inserting a spoon or other utensil into the container.

SAVE THESE INSTRUCTIONS

PRECAUTIONS TO AVOID POSSIBLE EXPOSURE TO EXCESSIVE MICROWAVE ENERGY

- (a) Do not attempt to operate this oven with the door open since open-door operation can result in harmful exposure to microwave energy. It is important not to defeat or tamper with the safety interlocks.
- (b) Do not place any object between the oven front face and the door or allow soil or cleaner residue to accumulate on sealing surfaces.
- (c) Do not operate the oven if it is damaged. It is particularly important that the oven door close properly and that there is no damage to the:
 - (1) Door (bent),
 - (2) Hinges and latches (broken or loosened),
 - (3) Door seals and sealing surfaces.
- (d) The oven should not be adjusted or repaired by anyone except properly qualified service personnel.

Electrical requirements

Observe all governing codes and ordinances. A 120 Volt, 60 Hz, AC only, 15 or 20 amp fused electrical supply is required. (A time-delay fuse is recommended.) It is recommended that a separate circuit serving only this appliance be provided.

DANGER



Electrical Shock Hazard
Plug into a grounded 3 prong outlet. Do not remove ground prong. Do not use an adapter. Do not use an extension cord.
Failure to follow these instructions can result in death, fire, or electrical shock.

GROUNDING INSTRUCTIONS

• **For all cord connected appliances:**
 The microwave oven must be grounded. In the event of an electrical short circuit, grounding reduces the risk of electric shock by providing an escape wire for the electric current. The microwave oven is equipped with a cord having a grounding wire with a grounding plug. The plug must be plugged into an outlet that is properly installed and grounded.

WARNING: Improper use of the grounding can result in a risk of electric shock.

Consult a qualified electrician or serviceman if the grounding instructions are not completely understood, or if doubt exists as to whether the microwave oven is properly grounded.

Do not use an extension cord. If the power supply cord is too short, have a qualified electrician or serviceman install an outlet near the microwave oven.

• **For a permanently connected appliance:**
 The microwave oven must be connected to a grounded, metallic, permanent wiring system, or an equipment grounding conductor should be run with the circuit conductors and connected to the equipment grounding terminal or lead on the microwave oven.

SAVE THESE INSTRUCTIONS

Getting to Know Your Microwave Oven

This section discusses the concepts behind microwave cooking. It also shows you the basics you need to know to operate your microwave oven. Please read this information before you use your oven.

HOW YOUR CAPITALIZE KENMORE MICROWAVE HOOD COMBINATION WORKS

Microwave energy is not hot. It causes food to make its own heat, and it's this heat that cooks the food.

Microwaves are like TV waves, radio waves, or light waves. You cannot see them, but you can see what they do.

A **magnetron** in the microwave oven produces microwaves. The microwaves move into the oven where they contact food as it turns on the turntable.

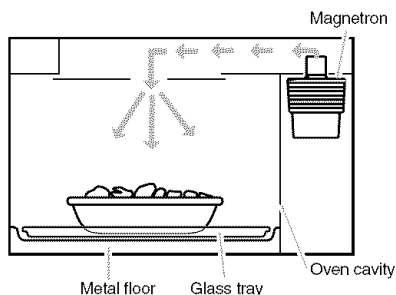

The **glass tray** of your microwave oven lets microwaves pass through. Then they bounce off a metal floor, back through the glass tray, and are absorbed by the food.

Microwaves pass through most glass, paper, and plastics without heating them so food absorbs the energy. Microwaves bounce off metal containers so food does not absorb the energy.

For the best cooking results

- **Always cook food** for the shortest cooking time recommended. Check to see how the food is cooking.
- **Stir, turn over, or rearrange** the food being cooked about halfway through the cooking time for all recipes. This will help make sure the food is evenly cooked.
- **If you do not have a cover for a dish**, use wax paper, or microwave-approved paper towels or plastic wrap. Remember to turn back a corner of the plastic wrap to vent steam during cooking.

Radio interference

Using your microwave oven may cause interference to your radio, TV, or similar equipment. When there is interference, you can reduce it or remove it by:

- **Cleaning** the door and sealing surfaces of the oven.

- **Adjusting** the receiving antenna of the radio or television.
- **Moving** the receiver away from the microwave oven.
- **Plugging** the microwave oven into a different outlet so that the microwave oven and receiver are on different branch circuits.

Testing your microwave oven

To test the oven put about 1 cup of cold water in a glass container in the oven. Close the door and make sure it latches.

Cook at 100% power for 1 minute. When the time is up, the water should be heated.

Testing your dinnerware or cookware

Test dinnerware or cookware before using. To test a dish for safe use, put it into the oven with a cup of water beside it. Cook at 100% cook power for one minute. **If the dish gets hot, do not use it.** Some dishes (melamine, some ceramic dinnerware, etc.) absorb microwave energy,

becoming too hot to handle and slowing cooking times. Cooking in metal containers not designed for microwave use could damage the oven, as could containers with hidden metal (twist-ties, foil lining, staples, metallic glaze or trim).

Operating safety precautions

- **Never** lean on the door or allow a child to swing on it when the door is open.
- **Use hot pads.** Microwave energy does not heat containers, but the heat from the food can make the container hot.
- **Do not** use newspaper or other printed paper in the oven.
- **Do not** dry flowers, fruit, herbs, wood, paper, gourds, or clothes in the oven.
- **Do not** start a microwave oven when it is empty. Product life may be shortened. If you practice programming the oven, **put** a container of water in the oven. It is normal for the oven door to look wavy after the oven has been running for a while.
- **Do not** try to melt paraffin wax in the oven. Paraffin wax will not melt in a microwave oven because it allows microwaves to pass through it.
- **Do not** operate the microwave oven unless the glass turntable is securely in place and can move freely. The turntable can move in either direction. **Make sure** the turntable is correct-side up in the oven. **Handle your turntable with care** when removing it from the oven to avoid possibly breaking it. If your turntable cracks or breaks, contact your dealer for a replacement.
- **When you use a browning dish**, the browning dish bottom must be at least 3/16 inch above the turntable. Follow the directions supplied with the browning dish.
- **Never cook or reheat a whole egg inside the shell.** Steam buildup in whole eggs may cause them to burst, and possibly damage the oven. **Slice** hard-boiled eggs before heating. In rare cases, poached eggs have been known to explode. **Cover** poached eggs and **allow** a standing time of one minute before cutting into them.
- **For best results, stir any liquid several times during heating or reheating.** Liquids heated in certain containers (especially containers shaped like cylinders) may become overheated. The liquid may splash out with a loud noise during or after heating or when adding ingredients (coffee granules, tea bags, etc.). This can harm you or damage the oven.
- **Microwaves** may not reach the center of a roast. The heat spreads to the center from the outer, cooked areas just as in regular oven cooking. This is one of the reasons for letting some foods (for example, roasts or baked potatoes) stand for a while after cooking, or for stirring some foods during the cooking time.
- **Do not deep fry in the oven.** Microwavable utensils are not suitable and it is difficult to maintain appropriate deep-frying temperatures.
- **Do not overcook potatoes.** At the end of the recommended cooking time, potatoes should be slightly firm because they will continue cooking during standing time. **After microwaving, let** potatoes stand for 5 minutes. They will finish cooking while standing.

Electrical connection

If your electric power line or outlet voltage is less than 110 volts, cooking times may be longer.

Have a qualified electrician check your electrical system.

SPECIFICATIONS

Power Supply		120V AC, 60 Hz
Rated Power Consumption	Microwave	1600W
	Convection	1700W
Power Output	Microwave	*950W
	Convection	1500W
Rated Current	Microwave	13.5A
	Convection	14.0A
Overall Dimensions(WxHxD)	29 15/16" x 16 7/16" x 15 3/8"	
Oven Cavity Dimensions(WxHxD)	21 1/4" x 9 7/16" x 14 3/16"	
Capacity of Oven Cavity	1.7 cu.ft	

*IEC 60705 RATING STANDARD

Specifications subject to change without prior notice.

Microwave oven features

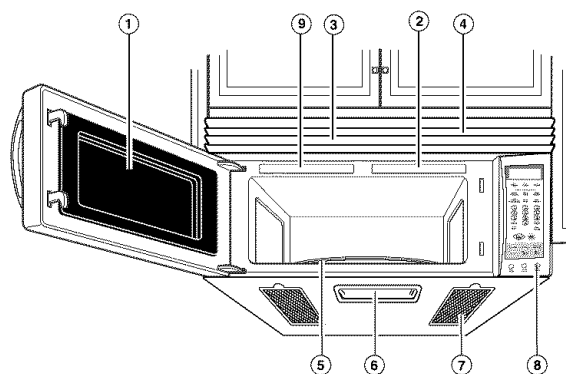

1. Metal Shielded Window. The shield prevents microwaves from escaping. It is designed as a screen to allow you to view food as it cooks.

2. Cooking Guide Label

3. Charcoal Filter (behind Vent Grille)

4. Vent Grille

5. Glass tray. The glass tray moves food as it cooks for more even cooking. It must be in the oven during operation for best cooking results.

6. Cooktop Light

7. Grease Filter. See “Caring for the filters” section.

8. Control Panel. Touch the pads on this panel to perform all functions.

9. Model and Serial Number Plate

Your microwave oven is designed to make your cooking experience as enjoyable and productive as possible. To get you up and running quickly, the following is a list of the oven’s basic features:

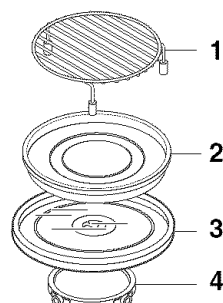

1. Convection Rack
2. Metal Tray/
Drip Pan
3. Turntable
4. Rotate Ring

The turntable rotates in both direction to help food cook more evenly. Do not operate the microwave oven without the glass tray in place.

To Install:

1. Place the support on the oven cavity bottom.
2. Place the glass tray on the support.

Fit the raised, hollowed groove of the glass tray bottom between the rollers of the hub. The rollers on the support should fit inside the glass tray bottom ridge.

Control panel features

Your microwave oven control panel lets you select the desired cooking function quickly and easily. All you have to do is touch the necessary Command Pad. The following is a list of all the Command and Number Pads located on the control panel. **For more information on these features, see “Using your microwave oven” section.**

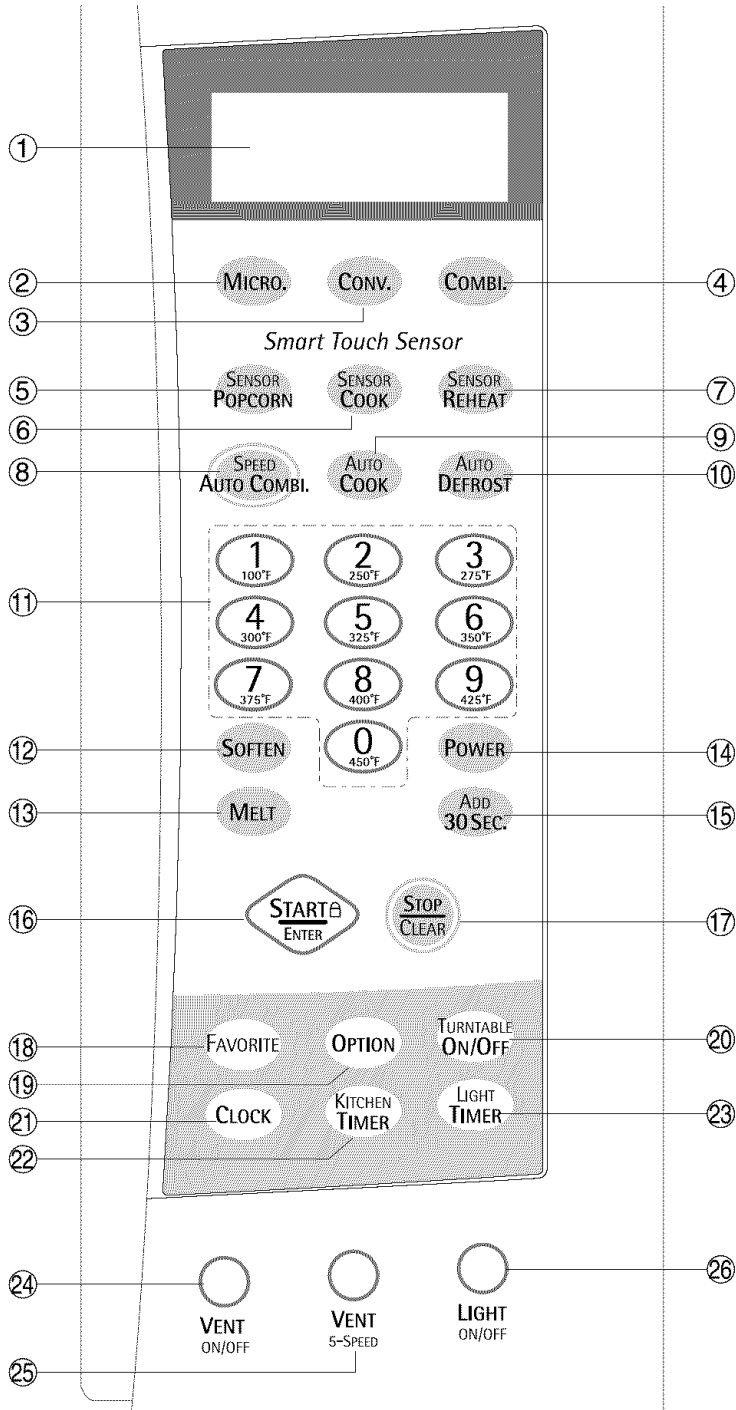

1. **DISPLAY.** The Display includes a clock and indicators to tell you time of day, cooking time settings and cooking functions selected.
2. **MICRO.** Touch this pad when setting Microwave cooking.
3. **CONV.** Touch this pad when setting Convection cooking.
4. **COMBI.** Touch this pad when setting combination cooking or preheat.
5. **SENSOR POPCORN.** Touch this pad when popping popcorn in your microwave oven. The oven's sensor will tell the oven how long to cook depending on the amount of humidity it detects from the popcorn.
6. **SENSOR COOK.** Touch this pad to cook baked potato, frozen vegetable, fresh vegetable, canned vegetable, frozen entree and rice. The oven's sensor will tell the oven how long to cook depending on the amount of humidity coming from the food.
7. **SENSOR REHEAT.** Touch this pad to reheat casserole, dinner plate, pizza slice and soup/sauce. The oven's sensor will tell the oven how long to cook depending on the amount of humidity coming from the food.
8. **SPEED AUTO COMBI.** Touch this pad when setting weight combination cooking.
9. **AUTO COOK.** Touch this pad to cook Bacon, Fresh Roll & Muffin, Frozen Roll & Muffin, Beverage, Chicken Pieces, Hot Cereal.
10. **AUTO DEFROST.** Touch this pad to select food type and defrost food by weight.
11. **NUMBER.** Touch number pads to enter cooking time, power level, quantities, weights, or cooking temperature.
12. **SOFTEN.** Touch this pad to soften Butter, Ice Cream, Cream Cheese or Frozen Juice.
13. **MELT.** Touch this pad to melt Butter or Margarine, Chocolate, Cheese or Marshmallow.
14. **POWER.** Touch this pad to select a cooking power level.
15. **ADD 30 SEC.** Touch this pad to set and start quickly at 100% power level.
16. **START/ENTER.** Touch this pad to start a function or enter all entries. If you open the door after oven begins to cook, touch START/ENTER again.
17. **STOP/CLEAR.** Touch this pad to stop the oven or to clear all entries.
18. **FAVORITE.** Touch this pad to recall one cooking instruction previously programmed into memory.
19. **OPTION.** Touch this pad to change the oven's default settings for sound, clock, display speed and defrost weight.
20. **TURNTABLE ON/OFF.** Touch this pad to turn off the turntable. OFF will appear in the display. **NOTE:** This option is not available in sensor cook and defrost modes.
21. **CLOCK.** Touch this pad to enter the time of day.
22. **KITCHEN TIMER.** Touch this pad to set the kitchen timer.
23. **LIGHT TIMER.** Touch this pad to set the light timer.
24. **VENT ON/OFF.** Touch this pad to turn the fan on/ off.
25. **VENT 5-SPEED.** Touch this pad to choose one of 5 fan speeds.
26. **LIGHT ON/OFF.** Touch this pad to turn on the cooktop/countertop light.

MICROWAVE COOKING TIPS

Amount of food

- **If you increase or decrease** the amount of food you prepare, the time it takes to cook that food will also change. For example, if you double a recipe, add a little more than half the original cooking time. Check for doneness and, if necessary, add more time in small increments.

Starting temperature of food

- **The lower the temperature** of the food being put into the microwave oven, the longer it takes to cook. Food at room temperature will be re-heated more quickly than food at refrigerator temperature.

Composition of food

- **Food with a lot of fat and sugar** will be heated faster than food containing a lot of water. Fat and sugar will also reach a higher temperature than water in the cooking process.
- **The more dense the food**, the longer it takes to heat. "Very dense" food like meat takes longer to heat than lighter, more porous food like sponge cakes.

Size and shape

- **Smaller pieces of food** will cook faster than larger pieces. Also, same-shaped pieces cook more evenly than different-shaped pieces.
- **With foods that have different thicknesses**, the thinner parts will cook faster than the thicker parts. **Place** the thinner parts of chicken wings and legs in the center of the dish.

Stirring, turning foods

- **Stirring and turning foods** spreads heat quickly to the center of the dish and avoids overcooking at the outer edges of the food.

Covering food

Cover food to:

- **Reduce** splattering
- **Shorten** cooking times
- **Keep** food moist

You can use any covering that lets microwaves pass through. See "Getting to Know Your Microwave Oven" for materials that microwaves will pass through. If you are using the Sensor function, be sure to vent.

Releasing pressure in foods

- **Several foods** (for example: baked potatoes, sausages, egg yolks, and some fruits) are tightly covered by a skin or membrane. Steam can build up under the membrane during cooking, causing the food to burst. To relieve the pressure and to prevent bursting, **pierce** these foods before cooking with a fork, cocktail pick, or toothpick.

Using standing time

- **Always allow food to stand** either in or out of the oven after cooking power stops. Standing time after defrosting and cooking allows the temperature to evenly spread throughout the food, improving the cooking results. For inside oven standing time, you can program a "0" power second stage of the cooking cycle. See Two-Stage Cooking.
- **The length of the standing time** depends on how much food you are cooking and how dense it is. Sometimes it can be as short as the time it takes you to remove the food from the oven and take it to the serving table. However, with larger, denser food item, the standing time may be as long as 10 minutes.

Arranging food

For best results, place food evenly on the plate. You can do this in several ways:

- **If you are cooking several items of the same food**, such as baked potatoes, **place** them in a ring pattern for uniform cooking.
- **When cooking foods of uneven shapes or thickness, such as chicken breasts, place** the smaller or thinner area of the food towards the center of the dish where it will be heated last.
- **Layer thin slices of meat** on top of each other.
- **When you cook or reheat whole fish, score** the skin – this prevents cracking.
- **Do not** let food or a container touch the top or sides of the oven. This will prevent possible arcing.

Using aluminum foil

Metal containers should not be used in a microwave oven. There are, however, some exceptions. If you have purchased food which is prepackaged in an aluminum foil container, refer to the instructions on the package. When using aluminum foil containers, cooking times may be longer because microwaves will only penetrate the exposed top of the food and not the bottom or the sides. If you use aluminum containers without package instructions, follow these guidelines:

MICROWAVE COOKING TIPS (CONT.)

Using aluminum foil (cont.)

- **Place** the aluminum foil container in a glass bowl and add some Water so that it covers the bottom of the container, but not more than 1/4 in. (.64 cm) deep. This ensures even heating of the container bottom.
- **Always remove** the container lid to avoid damage to the oven.
- **Use only** undamaged containers.
- **Do not use** containers taller than 3/4 in. (1.9 cm).
- **Container must be** at least half filled.
- **To avoid arcing**, there must be a minimum 1/4 in. (.64 cm) between the aluminum container and the walls of the oven and also between two aluminum containers.
- **Always place** the container on the turntable.
- **Shield** parts of food that may cook quickly, such as wing tips and leg ends of poultry, with small pieces of aluminum foil."
- **Heating food** in aluminum foil containers usually takes up to double the time compared to reheating in plastic, glass, china, or paper containers. The time when food is ready will vary depending upon the type of container you use.
- **Let food stand** for 2 to 3 minutes after heating so that heat is spread evenly throughout container.

Cooking you should not do in your microwave oven

- **Do not** do canning of foods in the oven. Closed glass jars may explode, resulting in damage to the oven.
- **Do not** use the microwave oven to sterilize objects (baby bottles, etc.). It is difficult to keep the oven at the high temperature needed for sterilization.

Removing the rack

- When popping commercially packaged popcorn, **Remove the rack and drip pan from the oven;** Do not place the bag of microwave popcorn on the rack or under the rack.

CAUTION : Popping microwave popcorn with rack and drip pan can cause fire or damage to your microwave oven.

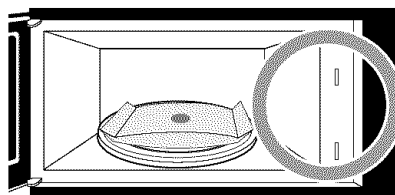
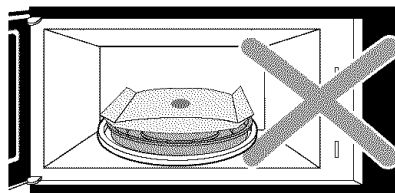
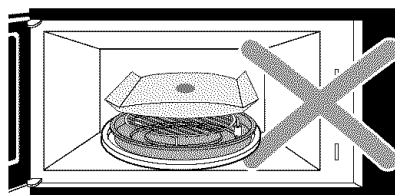

COOKING COMPARISON GUIDE

Cooking with your new oven offers a wide variety of food preparation options: microwave cooking, convection cooking, and combination cooking.

Microwave cooking uses very short, high-frequency radio waves. The movement of the microwaves through the food generates heat and cooks most foods faster than regular methods, while retaining their natural texture and moisture. Microwave cooking heats food directly, not the cookware or the interior of the oven. Reheating is easy and defrosting is particularly convenient because less time is spent in food preparation.

Convection cooking constantly circulates heated air around the food, creating even browning and sealed-in flavor by the constant motion of hot air over the food surfaces.

Combination cooking combines microwave energy with convection to cook with speed and accuracy, while browning and crisping to perfection.

You can use microwave cooking, convection cooking, or combination cooking to cook by time. Simply preset the length of cooking time desired and your oven turns off automatically.

The following guide shows at a glance the difference between microwave, convection, and combination cooking.

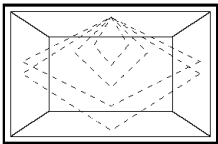
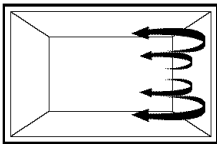
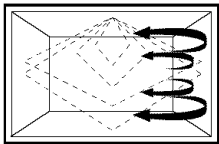
	MICROWAVE	CONVECTION	COMBINATION
COOKING METHOD	 <p>Microwave energy is distributed evenly throughout the oven for fast, thorough cooking of food.</p>	 <p>Hot air circulates around food to produce browned exteriors and sealed-in juices.</p>	 <p>Microwave energy and convection heat combine to shorten the cooking time of regular ovens, while browning and sealing in juices.</p>
HEAT SOURCE	Microwave energy.	Circulating heated air.	Microwave energy and circulating heated air.
BENEFITS	<ul style="list-style-type: none"> • Fast, high efficiency cooking. • Oven and surroundings do not get hot. • Easy clean-up. 	<ul style="list-style-type: none"> • Aids in browning and seals in flavor. • Cooks some foods faster than regular ovens. 	<ul style="list-style-type: none"> • Shortened cooking time from microwave energy. • Browning and crisping from convection heat.
<p>Read this guide to learn the many different things your Microwave/Convection/Combination Oven can do. You will find a wide variety of cooking methods and programs designed to suit your lifestyle.</p>			

COOKWARE GUIDE

Microwave Cooking

Most heat-resistant, non-metallic cookware is safe for use in your microwave oven.

However, to test cookware before using, follow these steps:

1. Place the empty cookware in the microwave oven.
2. Measure 1 cup of water in a glass measuring cup and place it in the oven beside the cookware.
3. Microwave on 100% power for 1 minute. If the dish is warm, it **should not** be used for microwave cooking.

Convection Cooking

- Metal Pans are recommended for all types of baked products, but especially where browning or crusting is important.
- Dark or dull finish metal pans are best for breads and pies because they absorb heat and produce a crisper crust.
- Shiny aluminum pans are better for cakes, cookies, or muffins because these pans reflect heat and help produce a light, tender crust.
- Glass or glass-ceramic casserole or baking dishes are best suited for egg and cheese recipes due to the cleanability of glass.

Combination Cooking

- Glass or glass-ceramic baking containers are recommended. Be sure not to use items with metal trim as it may cause arcing (sparking) with oven wall or oven shelf, damaging the cookware, the shelf or the oven.
- Heat-resistant plastic microwave cookware (safe to 450°F) may be used, but is not recommended for foods that require crusting or all-around browning, because plastic is a poor conductor of heat.

COOKWARE	MICROWAVE	CONVECTION	COMBINATION
Heat-Resistant Glass, Ceramic Glass	Yes	Yes	Yes
Ceramics, China	Yes (Do not use china with gold or silver trim.)	Yes	Yes
Metal Cookware	No	Yes	No
Non Heat-Resistant Glass	No	No	No
Microwave-Safe Plastic	Yes	No	Yes*
Plastic Wrap, Wax Paper	Yes	No	No
Paper Products	Yes	No	No
Straw, Wicker, and Wood	Yes	No	No

* Use only microwave cookware that is safe to 450°F

HOW TO USE ACCESSORIES

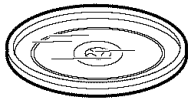

Glass Turntable

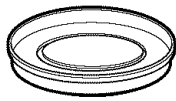

Metal Tray

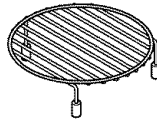

Metal Rack

- : Possible to use
 ⊙ : Recommended method
 X : Do not use

	MICROWAVE	CONVECTION	COMBINATION
	⊙	○	○
	X	○	○
	X	⊙	⊙
	X	⊙	X
	X	⊙	⊙

Notes :

- Do not operate the oven when it is empty except preheating.

Using Your Microwave Oven

This section gives you instructions for operating each function. Please read these instructions carefully.

AUDIBLE SIGNALS









Audible signals are available to guide you when setting and using your oven:

- **A programming tone will sound** each time you touch a pad.
- **Seven tones** signal the end of a Kitchen Timer countdown.
- **Four tones** signal the end of a cooking cycle.

CLOCK

When your microwave oven is first plugged in or after a power failure, the Display will show "PLEASE SET TIME OF DAY". If a time of day is not set, ":" will show on the Display until you touch "Clock".

Example: To set the clock for 10:30(AM).

- | Touch: | Display Shows: |
|--|-------------------------------------|
| 1.  | : |
| 2.  | ENTER TIME OF DAY |
| 3.     | 10 : 30 TOUCH ENTER |
| 4.  | 10 : 30
AM TOUCH 1
PM TOUCH 2 |
| 5.  | AM 10 : 30
TOUCH ENTER |
| 6.  | AM 10 : 30 |

NOTES:

- **If you enter** in an incorrect time and touch "Clock", you cannot set time of day. Enter the correct time.
- **If you touch** STOP/Clear while setting the clock, the Display will show the last time of day set or ":" if no time of day has been set.

INTERRUPTING COOKING



You can stop the oven during a cycle by opening the door. The oven stops heating and the fan stops, but the light stays on. **To restart cooking, close the door and Touch START/ENTER.**

If you do not want to continue cooking, open the door and touch STOP/Clear.

CHILD LOCK

Use this safety feature to lock the control panel when you are cleaning the oven, or so that children cannot use the oven unsupervised.

To set CHILD LOCK:

- | Touch: | Display Shows: |
|--|---|
| 1.  | Time of day. |
| 2.  | Touch and hold until LOCKED appears in the display. (approximately 4 seconds) |





To cancel CHILD LOCK:

- | Touch: | Display Shows: |
|--|--|
| 1.  | Time of day.
Touch and hold until LOCKED disappears in the display. (approximately 4 seconds) |

KITCHEN TIMER

Your microwave oven can be used as a kitchen timer. You can set up to 99 minutes, 99 seconds.



Example: To set 3 minutes.

- | Touch: | Display Shows: |
|--|-------------------------------------|
| 1.  | ENTER TIME IN MIN AND SEC |
| 2.    | 3 : 00 TOUCH START |
| 3.  | 3 : 00 TIMER
Time counting down. |

EXHAUST FAN

The bottom of the control panel controls the 5-speed exhaust fan.

Example: To set Level 4.

- | Touch: | Display Shows: |
|---|--|
| 1. 
VENT
ON/OFF | This shows the last level until you select the fan speed level. |
| 2. 
VENT
5-SPEED | <i>LEVEL 4</i>
Touch this pad until LEVEL 4 appears in the display. |

Turn off fan when desired

NOTE: If the temperature from the range or cooktop below the oven gets too hot, the exhaust fan in the vent hood will automatically turn on at the 4-Speed setting to protect the oven. It may stay on up to an hour to cool the oven. When this occurs, the Exhaust Fan pad will not turn the fan off. You cannot turn the exhaust fan off during microwave cooking.

COOKTOP LIGHT

A pad on the bottom of the control panel controls the cooktop light.









Example: To set the Lamp for HIGH.

- | Touch: | Display Shows: |
|---|------------------|
| 1. 
LIGHT
ON/OFF | <i>LIGHT ON</i> |
| 2. 
LIGHT
ON/OFF | <i>LIGHT OFF</i> |

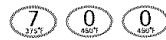

LIGHT TIMER

You can set the LIGHT to automatically turn on and off at specified times. The light comes on at the same time every day until reset.

Example: Turn on 2:00 AM, turn off 7:00 AM

- | Touch: | Display Shows: |
|--|--|
| 1.  | <i>ENTER LIGHT ON TIME
OR TOUCH CLEAR TO
RESET LIGHT TIMER</i> |
| 2.  | <i>2 : 00 TOUCH ENTER</i> |
| 3.  | <i>AM TOUCH 1
PM TOUCH 2</i> |
| 4.  | <i>PM 2 : 00 TOUCH ENTER</i> |
| 5.  | <i>ENTER LIGHT OFF
TIME</i> |
| 6.  | <i>TOUCH ENTER</i> |
| 7.  | <i>AM TOUCH 1
PM TOUCH 2</i> |
| 8.  | <i>TOUCH START</i> |
| 9.  | <i>SET LIGHT TIMER</i> |

To cancel the LIGHT TIMER when oven is On or Off.



- | Touch: | Display Shows: |
|--|--|
| 1.  | <i>ENTER LIGHT ON TIME
OR TOUCH CLEAR TO
RESET LIGHT TIMER</i> |
| 2.  | <i>RESET LIGHT TIMER</i> |

ADD 30 SEC.

A time-saving pad, this simplified control lets you quickly set and start microwave cooking at 100% power without the need to touch START/ENTER.

Example: To cook for 1 minutes.

Touch: **Display Shows:**

-  Time of day
-  Twice
Time counting down and **COOK.**
POWER 100

NOTE: Each time you touch 30 SEC., it will add 30 sec. up to 99 min, 59 sec.







TIMED COOKING

This feature lets you program a specific cook time and power. For best results, there are 10 power level settings in addition to HIGH (100%) power. Refer to the "Microwave Power Levels Table" on page 19 for more information.

NOTE: If you do not select a power level, the oven will automatically cook at HIGH (100%) power.

Example: To cook for 5 minutes, 30 seconds at 80% power.

Touch: **Display Shows:**













-  *ENTER COOKING TIME*
-    *5 : 30 TOUCH START
OR POWER LEVEL*
-  *5 : 30 POWER 100
ENTER POWER LEVEL
0 TO 10*
-  *5 : 30 POWER 80
TOUCH START*
-  Time counting down and **COOK.**
POWER 80

TWO - STAGE COOKING

For best results, some recipes call for different power levels during a cook cycle. You can program your oven for 2 power level stages during the cook cycle.

Example: To set a 2-stage cook cycle.

Touch: **Display Shows:**

-  *ENTER COOKING TIME*
-    *3 : 00 TOUCH START
OR POWER LEVEL*
to set a 3 minute cook time for first stage.
-  *3 : 00 POWER 100
ENTER POWER LEVEL
0 TO 10*
-  *3 : 00 POWER 80
TOUCH START*
to set an 80% cook power for the first stage.
-  *ENTER COOKING TIME*
-    *7 : 00 TOUCH START
OR POWER LEVEL*
to set a 7 minute cook time for second stage.
-  *7 : 00 POWER 100
ENTER POWER LEVEL
0 TO 10*
-  *7 : 00 POWER 50
TOUCH START*
to set a 50% cook power for the second stage.
-  Time counting down and **COOK.**
1st stage *POWER 80*
2nd stage *POWER 50*
- When the first stage is over, you will hear two short tones as the oven begins the second cook stage.

MICROWAVE POWER LEVELS

For best results, some recipes call for different cook powers. The lower the cook power, the slower the cooking. Each number from 10 to 0 stands for a different percentage of full cook power.

The following chart gives the percentage of cook power each number pad stands for, and the cook power name usually used.

It also tells you when to use each cook power. Follow recipe or food package instructions if available.



NOTE: Refer to a reliable cookbook for cooking times based on the 950 Watt cook power of your microwave oven.

COOK Power	LEVEL	WHEN TO USE IT
100% of full power	High	<ul style="list-style-type: none"> • Quick heating many convenience foods and foods with high water content, such as soups and beverages. • Cooking tender cuts of meat, ground meat,
9 = 90% of full power		<ul style="list-style-type: none"> • Heating cream soups
8 = 80% of full power		<ul style="list-style-type: none"> • Heating rice, pasta, or casseroles
7 = 70% of full power	Medium-High	<ul style="list-style-type: none"> • Cooking and heating foods that need a Cook Power lower than high (for example, whole fish and meat loaf) or when food is cooking too fast • Reheating a single serving of food
6 = 60% of full power		<ul style="list-style-type: none"> • Cooking requiring special care, such as cheese and egg dishes, pudding, and custards • Finishing cooking casseroles
5 = 50% of full power	Medium	<ul style="list-style-type: none"> • Cooking ham, whole poultry, and pot roasts • Simmering stews
4 = 40% of full power		<ul style="list-style-type: none"> • Melting chocolate • Heating pastries
3 = 30% of full power	Medium-Low, Defrost	<ul style="list-style-type: none"> • Manually defrosting foods, such as bread, fish, meats, poultry, and precooked foods
2 = 20% of full power		<ul style="list-style-type: none"> • Softening butter, cheese, and ice cream
1 = 10% of full power	Low	<ul style="list-style-type: none"> • Keeping food warm • Taking chill out of fruit
0 = 0% of full power	None	<ul style="list-style-type: none"> • Standing time in oven

TURNTABLE ON/OFF

For best cooking results, leave the turntable on. It can be turned off for large dishes.

Touch: **Display Shows:**

1.  *OFF T/TABLE*
2.  *ON T/TABLE*

Press TURNTABLE ON/OFF to turn the turntable on or off.

NOTE:

- This option is not available in sensor cook and defrost modes.
- **Sometimes the turntable can become hot to touch.** Be careful touching the turntable during and after cooking.
- **Do not run the oven empty.**



OPTION

You can change the default values for beep sound, clock, display speed and defrost weight. See following chart for more information.

No.	Function	No.	Result
1	Beep ON/ OFF control	1	Sound ON
		2	Sound OFF
2	Clock display control	1	Clock ON
		2	Clock OFF
3	Display	1	Slow speed
		2	Normal speed
		3	Fast speed
4	Defrost weight mode selected	1	Lbs.
		2	Kg.

Example: To change defrost weight mode (from Lbs. to Kg).

Touch: **Display Shows:**







1.  *SOUND ON/OFF TOUCH 1
CLOCK ON/OFF TOUCH 2
SCROLL SPEED TOUCH 3
LBS/KG TOUCH 4*
2.  *LBS TOUCH 1
KG TOUCH 2*
3.  *KG*

FAVORITE

FAVORITE RECIPE lets you recall one cooking instruction previously placed in memory and begin cooking quickly.



Example: To cook for 2 minutes.

Touch: **Display Shows:**

1.  *1 : 00 POWER 100
TOUCH START OR
MANUAL KEY*
2.  *ENTER COOKING TIME*
3.    *2 : 00 TOUCH START
OR POWER LEVEL*
Time counting down.
POWER 100
4. 

Example: To recall the custom recipe.

Touch: **Display Shows:**





1.  *2 : 00 POWER 100
TOUCH START OR
MANUAL KEY*
2.  *Time counting down and
cook.
POWER 100*

When the cook time is over, you will hear four beeps and **COOK END** will display.

MELT

The oven uses low power to melt foods (butter or margarine, chocolate, marshmallows, or processed cheese food). See the following table.





Example for 8 oz. Chocolate:

- | | |
|--|---|
| Touch: | Display Shows: |
| 1.  | Time of day |
| 2.  | <i>SELECT MENU 1 TO 4</i> |
| 3.  | <i>CHOCOLATE TOUCH 1 TO 2</i> |
| 4.  | <i>8 oz TOUCH START</i> |
| 5.  | Time counting down.
<i>CHOCOLATE</i> |

SOFTEN

The oven uses low power to soften foods (butter, ice cream, cream cheese, and frozen juice). See the following table.

Example for quart of ice cream:

- | | |
|--|---|
| Touch: | Display Shows: |
| 1.  | Time of day |
| 2.  | <i>SELECT MENU 1 TO 4</i> |
| 3.  | <i>ICE CREAM TOUCH 1 TO 3</i> |
| 4.  | <i>QUART TOUCH START</i> |
| 5.  | Time counting down.
<i>ICE CREAM</i> |

MELT TABLE

CODE	CATEGORY	DIRECTION	AMOUNT
1	Butter or Margarine	Unwrap and place in microwavable container. No need to cover butter. Stir at the end of cooking to complete melting.	1, 2 or 3 sticks
2	Chocolate	Chocolate chips or squares of baking chocolate may be used. Unwrap squares and place in microwavable container. Stir at the end of cycle to complete melting.	4 or 8 oz.
3	Cheese	Use processed cheese food only. Cut into cubes. Place in a single layer in microwavable container. Stir at the end of cooking to complete melting.	8 or 16 oz.
4	Marshmallows	Large or miniature marshmallows may be used. Place in microwavable container. Stir at the end of cycle to complete melting.	5 or 10 oz.

SOFTEN TABLE

CODE	CATEGORY	DIRECTION	AMOUNT
1	Butter	Unwrap and place in microwavable container. Butter will be at room temperature and ready for use in recipe.	1, 2 or 3 sticks
2	Ice cream	Place container in oven. Ice cream will be soft enough to make scooping easier.	Pint, Quart, Half gallon
3	Cream cheese	Unwrap and place in microwavable Container. Cream cheese will be at room temperature and ready for use in recipe.	3 or 8 oz.
4	Frozen juice	Remove top. Place in oven. Frozen juice will be soft enough to easily mix with water.	6, 12 or 16 oz.

AUTO DEFROST





Three defrost sequences are preset in the oven. The auto defrost feature provides you with the best defrosting method for frozen foods. The Auto Defrost Table will show you which defrost sequence is recommended for the food you are defrosting. For added convenience, the Auto Defrost includes a built-in beep mechanism that reminds you to check, turn over, separate, or rearrange to get best defrost results. Three different defrost settings are provided.

- 1 MEAT
- 2 POULTRY
- 3 FISH
- 4 BREAD
- 5 RAPID - only 1 lb.

*You can set Auto Defrost from 0.1 to 6.0 pounds in each setting.

Example: To defrost 1.2 lbs of ground beef.

Touch: **Display Shows:**

1.  *MEAT TOUCH 1
POULTRY TOUCH 2
FISH TOUCH 3
BREAD TOUCH 4
RAPID TOUCH 5*
2.  *MEAT
ENTER WEIGHT*
3.  and  to enter the weight *1.2 Lbs
TOUCH START*
4.  Time counting down. *DEFROST*

NOTE:

When you touch the START/ENTER pad, the display changes to defrost time count down. The oven will beep during the DEFROST cycle. At this time, open the door and turn, separate, or rearrange the food. Remove any portions that have thawed. Return frozen portions to the oven and touch START/ENTER to resume the defrost cycle.

OPERATING TIPS

- For best results, remove fish, shellfish, meat, and poultry from its original closed paper or plastic package (wrapper). Otherwise, the wrap will hold steam and juice close to the foods, which can cause the outer surface of the foods to cook.
- For best results, shape your ground meat into the form of a doughnut before freezing. When defrosting, scrape off thawed meat when the beep sounds and continue defrosting.
- Place foods in a shallow container or on a microwave roasting rack to catch drippings.
- For more defrost help, please read "Defrosting Tips" following the Auto Defrost Table.

This table shows you food type selections and the weights you can set for each type. For best results, loosen or remove covering on food.

FOOD	TOUCH Auto Defrost	WEIGHTS YOU CAN SET (tenths of a pound)
Meat	1	.1 to 6.0 (45g to 2722g)
Poultry	2	.1 to 6.0 (45g to 2722g)
Fish	3	.1 to 6.0 (45g to 2722g)
Bread	4	.1 to 1.0 (45g to 454g)
Rapid	5	only 1 lb.

Weight conversion table

You are probably used to food weights as being in pounds and ounces that are fractions of a pound (for example, 4 ounces equals 1/4 pound). However, in order to enter food weight in Auto Defrost, you must specify pounds and tenths of a pound. If the weight on the food package is in fractions of a pound, you can use the following table to convert the weight to decimals.

Equivalent Weight		
OUNCES	DECIMAL WEIGHT	
1.6	.10	
3.2	.20	
4.8	.30	
6.4	.40	
8.0	.50	One-Half Pound
9.6	.60	
11.2	.70	
12.8	.80	
14.4	.90	
16.0	1.00	One Pound

AUTO DEFROST TABLE

Meat setting

FOOD	SETTING	AT BEEP	SPECIAL INSTRUCTIONS
BEEF			Large, irregular shaped and fatty cuts of meat should have the narrow or fatty areas shielded with foil at the beginning of a defrost sequence.
Ground Beef, Bulk	MEAT	Remove thawed portions with fork. Turn over. Return remainder to oven.	Do not defrost less than 1/4 lb. Freeze in doughnut shape.
Ground Beef, Patties	MEAT	Separate and rearrange.	Do not defrost less than 2 oz. patties. Depress center when freezing.
Round Steak	MEAT	Turn over. Cover warm areas with aluminum foil.	Place on a microwavable roasting rack.
Tenderloin Steak	MEAT	Turn over. Cover warm areas with aluminum foil.	Place on a microwavable roasting rack.
Stew Beef	MEAT	Remove thawed portions with fork. Separate remainder. Return remainder to oven.	Place in a microwavable baking dish.
Pot Roast, Chuck Roast	MEAT	Turn over. Cover warm areas with aluminum foil.	Place on a microwavable roasting rack.
Rib Roast	MEAT	Turn over. Cover warm areas with aluminum foil.	Place on a microwavable roasting rack.
Rolled Rump Roast	MEAT	Turn over. Cover warm areas with aluminum foil.	Place on a microwavable roasting rack.
LAMB			
Cubes for Stew	MEAT	Remove thawed portions with fork. Return remainder to oven.	Place in a microwavable baking dish.
Chops (1 inch thick)	MEAT	Separate and rearrange.	Place on a microwavable roasting rack.
PORK			
Chops (1/2 inch thick)	MEAT	Separate and rearrange.	Place on a microwavable roasting rack.
Hot Dogs	MEAT	Separate and rearrange.	Place on a microwavable roasting rack.
Spareribs Country-style Ribs	MEAT	Turn over. Cover warm areas with aluminum foil.	Place on a microwavable roasting rack.
Sausage, Links	MEAT	Separate and rearrange.	Place on a microwavable roasting rack.
Sausage, Bulk	MEAT	Remove thawed portions with fork. Turn over. Return remainder to oven.	Place in a microwavable baking dish.
Loin Roast, Boneless	MEAT	Turn over. Cover warm areas with aluminum foil.	Place on a microwavable roasting rack.

AUTO DEFROST TABLE (CONT.)

Poultry setting

FOOD	SETTING	AT BEEP	SPECIAL INSTRUCTIONS
CHICKEN Whole (up to 6 lbs)	POULTRY	Turn over (finish defrosting breast-side down). Cover warm areas with aluminum foil.	Place chicken breast-side up on a microwavable roast rack. Finish defrosting by immersing in cold water. Remove giblets when chicken is partially defrosted.
Cut-up		Separate pieces and rearrange. Turn over. Cover warm areas with aluminum foil.	Place on a microwavable roasting rack. Finish defrosting by immersing in cold water.
CORNISH HENS Whole	POULTRY	Turn over. Cover warm areas with aluminum foil.	Place on a microwavable roasting rack. Finish defrosting by immersing in cold water.
TURKEY Breast (up to 6 lbs)	POULTRY	Turn over. Cover warm areas with aluminum foil.	Place on a microwavable roasting rack. Finish defrosting by immersing in cold water.

Fish setting

FOOD	SETTING	AT BEEP	SPECIAL INSTRUCTIONS
FISH Fillets	FISH	Turn over. Separate fillets when partially thawed if possible.	Place in a microwavable baking dish. Carefully separate fillets under cold water.
Steaks	FISH	Separate and rearrange.	Place in a microwavable baking dish. Run cold water over to finish defrosting.
Whole	FISH	Turn over.	Place in a microwavable baking dish. Cover head and tail with foil; do not let foil touch sides of microwave. Finish defrosting by immersing in cold water.
SHELLFISH Crabmeat	FISH	Break apart. Turn over.	Place in a microwavable baking dish.
Lobster tails	FISH	Turn over and rearrange.	Place in a microwavable baking dish.
Shrimp	FISH	Separate and rearrange.	Place in a microwavable baking dish.
Scallops	FISH	Separate and rearrange.	Place in a microwavable baking dish.

Bread setting

FOOD	SETTING	AT BEEP	SPECIAL INSTRUCTIONS
Bagel Dinner Roll Muffin Hamburger Hot Dog Bun Slices of Bread Loaf of Bread	BREAD	Turn over and rearrange.	Place on 3 sheets of paper towel.

DEFROSTING TIPS

- **When using** Auto Defrost, the weight to be entered is the net weight in pounds and tenths of pounds (the weight of the food minus the container).
- **Before starting**, make sure you have removed any of the metal twist-ties which often come with frozen food bags, and replace them with strings or elastic bands.
- **Open containers** such as cartons before they are placed in the oven.
- **Always slit** or pierce plastic pouches or packaging.
- **If food is foil wrapped**, remove foil and place it in a suitable container.
- **Slit** the skins, if any, of frozen food such as sausage.
- **Bend** plastic pouches of food to ensure even defrosting.
- **Always underestimate** defrosting time. If defrosted food is still icy in the center, return it to the microwave oven for more defrosting.
- **The length** of defrosting time varies according to how solidly the food is frozen.
- **The shape of the package** affects how quickly food will defrost. Shallow packages will defrost more quickly than a deep block.
- **As food begins to defrost**, separate the pieces. Separated pieces defrost more easily.
- **Use small pieces of aluminum foil** to shield parts of food such as chicken wings, leg tips, fish tails, or areas that start to get warm. Make sure the foil does not touch the sides, top, or bottom of the oven. The foil can damage the oven lining.
- **For better results**, let food stand after defrosting. (For more information on standing time, see the "Microwave Cooking Tips" section.)
- **Turn over** food during defrosting or standing time. Break apart and remove food as required.

Using Sensor Cooking

SENSOR OPERATING INSTRUCTIONS

Sensor Cook allows you to cook most of your favorite foods without selecting cooking times and power levels. The display will indicate Sensing during the initial sensing period. The oven automatically determines required cooking time for each food item. When the internal sensor detects a certain amount of humidity coming from the food, it will tell the oven how much longer to heat. The display will show the remaining heating time. For best results for cooking by Sensor, follow these recommendations.

1. Food cooked with the sensor system should be at normal storage temperature.
2. Glass Tray (TURNTABLE) and outside of container should be dry to assure best cooking results.
3. Foods should always be covered with microwavable plastic wrap, waxed paper, or a lid.
4. Do not open the door or touch the **STOP/CLEAR** key during the sensing time. When sensing time is over, the oven beeps and the remaining cooking time will appear in the display window. At this time you can open the door to stir, turn, or rearrange the food.

SENSOR COOK GUIDE

Appropriate containers and coverings help assure good Sensor cooking results.

1. Always use microwavable containers and cover them with lids or plastic wrap.
2. Never use tight-sealing plastic covers. They can prevent steam from escaping and cause food to overcook.
3. Match the amount to the size of the container. Fill containers at least half full for best results.
4. Be sure the outside of the cooking container and the inside of the microwave oven are dry before placing food in the oven. Beads of moisture turning into steam can mislead the sensor.

SENSOR POPCORN

Popcorn lets you pop popcorn without needing to program times and power.

Example : To pop popcorn.

Touch: **Display Shows:**

1.  *POPCORN*



When the cook time is over, you will hear four beeps and **COOK END** will display.

SENSOR COOK

Using SENSOR COOK lets you heat common microwave-prepared foods without needing to program times and Cook Powers. SENSOR COOK has preset Cook Power for 6 food categories.

Example: To cook rice.

Touch: **Display Shows:**

1.  *SELECT MENU 1 TO 6*
2.  *RICE*



When the cook time is over, you will hear four beeps and **COOK END** will display.

SENSOR REHEAT

Using SENSOR REHEAT lets you reheat common microwave-prepared foods without selecting cooking times and power levels.

Example: To reheat 2 slices of pizza.

Touch: **Display Shows:**

1.  *SELECT MENU 1 TO 4*
2.  *PIZZA SLICE*

When the cook time is over, you will hear four beeps and **COOK END** will display.

SENSOR COOK TABLE

TOUCH PAD NUMBER	CATEGORY	DIRECTION	AMOUNT
1	Baked Potato	Pierce each potato with a fork and place the oven tray around the edge, at least one inch apart. After cooking, allow to stand for 5 minutes.	1~4 medium (approx. 8 to 10 oz. each)
2	Frozen Vegetable	Remove from package, rinse off frost under running water. Place in an appropriately sized microwave container. Add amount of water according to the quantity (1~2 cups : 2 tablespoons, 3~4 cups : 4 tablespoons). Cover with plastic wrap and vent. After cooking, stir and allow to stand for 3 minutes.	1~4 cups
3	Fresh Vegetable	Prepare as desired, wash, and leave residual water on the vegetables. Place in an appropriately sized microwave container. Add amount of water according to the quantity (1~2 cups : 2 tablespoons, 3~4 cups : 4 tablespoons). Cover with plastic wrap and vent. After cooking, stir and allow to stand for 3 minutes.	1~4 cups
4	Canned Vegetable	Remove from the outer display can. Place in an appropriately sized microwave container, cover with plastic wrap, and vent. After cooking, stir and allow to stand for 3 minutes.	1~4 cups
5	Frozen Entree	Remove from outer display package. Slit cover. If not in microwave-safe container, place on a plate. Cover with plastic wrap and vent the plastic film by piercing with a fork (3 times). After cooking, allow to stand for 3 minutes.	10 to 21 oz.
6	Rice	Place rice and twice as much liquid (water, chicken or vegetable stock) in a 2 quart microwave dish. Cover with plastic wrap and vent. After cooking, allow to stand for 10 minutes. Stir for fluffier rice.	1/2-2 cups Use medium or long grain rice. Cook instant rice according to directions on the package.

SENSOR REHEAT TABLE

TOUCH PAD NUMBER	CATEGORY	DIRECTION	AMOUNT
1	Dinner Plate	Place on a low plate. Cover with vented plastic wrap. Let stand 3 minutes after cooking.	1 to 2 servings
2	Soup/Sauce	Place in shallow microwavable casserole. Cover with vented plastic wrap. After cooking, Stir and let stand 3 minutes.	1~4 cups
3	Casserole	Place in a microwavable bowl or casserole. Cover with vented plastic wrap. After cooking, Stir and let stand 3 minutes.	1~4 cups
4	Pizza Slice	This is reheat function for a leftover pizza. Place on paper towel on a microwave safe plate.	1~4 slices

AUTO COOK

Auto Cook provides 6 preset categories for cooking.

Example: To cook bacon 2 slices.

Touch: **Display Shows:**

- | | | |
|----|---|---|
| 1. |  | <i>SELECT MENU 1 TO 6</i> |
| 2. |  | <i>BACON TOUCH 2 TO 6</i> |
| 3. |  | <i>2 SLICES
TOUCH START</i> |
| 4. |  | Time counting down
and cook.
<i>BACON</i> |

AUTO COOK TABLE

TOUCH PAD NUMBER	CATEGORY	DIRECTION	AMOUNT
1	Bacon	Place bacon strips on a microwave bacon rack for best results. (Use dinner plate lined with paper towels if rack is not available)	2~6 slices
2	Fresh Roll/Muffin	Remove from display package and place on plate. (If muffins are over 3 oz. each, count as two when entering quantity.)	1~6 pieces (2-3 oz. each)
3	Frozen Roll/Muffin	Remove from display package and place on plate. (If muffins are over 3 oz. each, count as two when entering quantity.)	1~6 pieces (2-3 oz. each)
4	Beverage	Use a wide-mouth mug. Do not cover. Remove from display package and place on a plate. (Be careful! The beverage will be very hot! Sometimes liquids heated in cylindrical containers will splash out when the cup is moved.)	1~2 cups
5	Chicken Pieces	Place the chicken pieces in an appropriately sized microwavable container, cover with plastic wrap, and vent.	0.5 ~ 2 lbs.
6	Hot cereal	Prepare as directed on package and cook. Stir well before eating. Use only instant hot cereal.	1~6 servings

TIPS FOR CONVECTION COOKING

This section gives you cooking instructions and procedures for operating each convection function. Please read these instructions carefully.

Convection cooking circulates hot air through the oven cavity with a fan. The constantly moving air surrounds the food to heat the outer portion quickly, creating even browning and sealed-in flavor by the constant motion of hot air over the food surfaces. Your oven uses convection cooking whenever you use the Convection Button. **DO NOT USE THE OVEN WITHOUT THE TURNTABLE IN PLACE.**

1. **Always use the metal rack** on the turntable when convection cooking.
2. **Do not cover** turntable or metal rack with aluminum foil. It interferes with the flow of air that cooks the food.
3. **Round pizza pans** are excellent cooking utensils for many convection-only items. Choose pans that do not have extended handles.
4. **Use convection cooking** for items like soufflés, breads, cookies, angel food cakes, pizza, and for some meat and fish cooking.
5. **Your oven comes** equipped with metal tray which can be used for cooking in convection mode or combination mode.
6. **You do not need to use** any special techniques to adapt your favorite oven recipes to convection cooking; however, you need to lower oven temperature by 25°F from recommended temperature mentioned in package instructions when cooking packaged food in convection mode.

7. **When baking** cakes, cookies, breads, rolls, or other baked foods, most recipes call for preheating. Preheat the empty oven just as you do a regular oven. You can start heavier dense foods such as meats, casseroles, and poultry without preheating.
8. **All heatproof** cookware or metal utensils can be used in convection cooking.
9. **As in conventional cooking**, the distance of the food from the heat source affects cooking results. Refer to the charts in this Use and Care Guide.
10. **Use metal utensils** only for convection cooking. Never use for microwave or combination cooking since arcing and damage to the oven may occur.
11. **After preheating**, if you do not open the door, the oven will automatically hold at the preheated temperature for 30 minutes.

PRECAUTIONS

- The oven cavity, door, turntable, roller rest, metal tray, metal rack, and cooking utensils will become very hot. **USE THICK OVEN GLOVES** when removing the food, cooking utensils, metal rack, metal tray, and turntable from the oven after convection cooking.
- Do not use lightweight plastic containers, plastic wraps, or paper products during any convection cycle.

CONVECTION







During convection cooking, a heating element is used to raise the temperature of the air inside the oven. Convection cooking temperature ranges from 100°F to 450°F.

It is best to preheat the oven when convection cooking.

Note: Lower oven temperature by 25°F from package recommended temperature, instructions. The baking time may vary according to the food condition or individual preference.

Example: To set the convection cooking at 325°F for 45 minutes with preheating.

Touch: **Display Shows:**







1.  Time of day
2.  350 F ENTER
TEMPERATURE OR
TOUCH ENTER
3.  325 F TOUCH ENTER
4.  2X 325 F PREHEAT
5.  45 : 00
TOUCH START
Time counting down
and cook.
6.  325 F CONVECTION

NOTES:

- When the oven reaches the set preheat temperature, five (5) tones will sound and the display will scroll the message "PREHEAT END". The oven will automatically hold that temperature for 30 minutes.
- The oven temperature drops very quickly when the door is opened; however, this should not prevent food from being fully cooked during normal cooking time.
- During convection cooking, the exhaust fan in the vent hood will automatically turn on at the 1-speed setting to protect the oven

Example: To set the convection cooking at 375°F for 30 minutes without preheating.

Touch: **Display Shows:**

1.  Time of day
 2.  350 F ENTER
TEMPERATURE OR
TOUCH ENTER
 3.  375 F TOUCH ENTER
 4.  375 F ENTER
COOKING TIME
- NOTE:** If you press the start button, it will operate.
5.  30 : 00
375 F TOUCH START
Time counting down
and cook.
 6.  375 F CONVECTION

NOTE:

The temperature range has 10 steps from 100°F to 450°F.

CONVECTION BAKING GUIDELINES

1. Always use the metal rack when convection baking. Place food directly on rack or place in metal tray and then place tray on rack. (See page 15.)
2. Aluminum pans conduct heat quickly. For most convection baking, light, shiny finishes give best results because they prevent overbrowning in the time it takes to cook the center areas. Pans with dull (satin-finish) bottoms are recommended for cake pans and pie pans for best bottom browning.
3. Dark or non-shiny finishes, glass, and pyroceram absorb heat which may result in dry, crisp crusts.
4. Preheating the oven is recommended when baking foods by convection.
5. To prevent uneven heating and save energy, open the oven door to check food as little as possible.

Food		Oven Temp.	Time, Min.	Comments
Breads	Refrigerated Biscuits	375°F	11 to 14	Allow additional time for large biscuits.
	Corn Bread	350°F	35 to 40	
	Muffins	425°F	18 to 22	Remove from pans immediately and cool slightly on wire rack.
	Popovers	325°F	45 to 55	Pierce each popover with a fork after removing from oven to allow steam to escape.
	Nut Bread or Fruit Bread	325°F	60 to 70	Interiors will be moist and tender.
	Yeast Bread	375°F	16 to 23	
	Plain or Sweet Rolls	350°F	13 to 16	Lightly grease baking sheet.
Cakes	Devil's Food	350°F	35 to 40	Place cake pan on rack.
	Fudge brownies	350°F	26 to 30	Bake 2 layers of brownies at a time.
	Coffee Cake	325°F	30 to 35	
	Cup Cakes	325°F	20 to 25	
	Fruit Cake (loaf)	275°F	90 to 100	Interior will be moist and tender.
	Gingerbread	300°F	25 to 30	
	Butter Cakes, Cake Mixes	325°F	35 to 45	
	9 x 13a	325°F	35 to 45	Turn end for end half way through baking.
	Tube Cake	325°F	30 to 40	Grease and flour pan.
Pound Cake	325°F	45 to 55	Cool in pan 10 minutes before inverting on wire rack.	
Cookies	Chocolate Chip	350°F	11 to 14	Place metal tray on rack. Allow extra time for frozen cookie dough.
	Sugar	350°F	11 to 14	Place metal tray on rack.
Fruits, Other Desserts	Baked Apples or Pears	350°F	35 to 40	Bake in cookware with shallow sides.
	Bread Pudding	300°F	35 to 40	Pudding is done when knife inserted near center comes out clean.
	Cream Puffs	400°F	30 to 35	Puncture puffs twice with toothpick to release steam after 25 minutes of baking time.
	Meringue Shells	300°F	30 to 35	When done, turn oven off and let shells stand in oven 1 hour to dry.

Notes:

- The oven temperature indicated in the chart above is recommended over the package instruction temperature.
- The baking time in the chart above is only a guideline for your reference. You need to adjust time according to the food condition or your preference. Check doneness at the minimum time.

CONVECTION BAKING GUIDELINES (CONT'D)

Food		Oven Temp.	Time, Min.	Comments
Pies, Pastries	Frozen Pie	400°F	50 to 60	Place metal tray on rack and place in cold oven. Preheat oven, tray and rack to 400°F. When preheated, place frozen pie on metal tray and bake according to package time or until crust is browned and filling is hot.
	Meringue-Topped	450°F	9 to 11	Follow package directions for preparation.
	Two-Crust	400°F	50 to 55	Follow package directions for preparation.
	Quiche	350°F	30 to 35	Let stand 5 minutes before cutting.
	Pastry Shell	400°F	10 to 16	Pierce pastry with fork to prevent shrinkage.
Casseroles	Meat, Chicken, Seafood Combinations	350°F	20 to 40	Cook times vary with casserole size and ingredients.
	Pasta	350°F	25 to 45	Cook times vary with casserole size and ingredients.
	Potatoes, scalloped	350°F	55 to 60	Let stand 5 minutes before serving.
	Vegetable	350°F	25 to 35	Cook times vary with casserole size and ingredients.
Convenience Foods	Frozen Bread Dough	350°F	30 to 35	Follow package directions for preparation.
	Frozen Entree	325°F	70 to 80	Follow package directions for preparation.
	Frozen Pizza Rising Crust	400°F	25 to 35	Follow package directions for preparation. Pizza should not extend over the rack.
	Frozen Pizza	400°F	17 to 21	Follow package directions for preparation. Pizza should not extend over the rack.
	French Fries Crinkle Cut	450°F	15 to 19	Follow package directions for preparation.
	Frozen Waffle	400°F	5 to 7	Follow package directions for preparation.
	Frozen Cheese Sticks	450°F	6 to 8	Follow package directions for preparation.
	Frozen Turnovers	450°F	18 to 22	Follow package directions for preparation.
Main Dishes	Meat Loaf	400°F	30 to 40	Let stand 5 minutes after cooking.
	Oven-Baked Stew	325°F	80 to 90	Brown meat before combining with liquid and vegetables.
	Swiss Steak	350°F	60 to 70	Let stand 2 minutes after cooking.
	Stuffed Peppers	350°F	40 to 45	Use green, red, or yellow peppers.
Vegetables	Acorn Squash Halves	375°F	55 to 60	Pierce skin several places. Add 1/2 cup water to dish. Turn squash halves cut side up after 30 minutes of cook time and cover.
	Baked Potatoes	425°F	50 to 60	Pierce skin with fork before baking.
	Twice-Baked Potatoes	400°F	25 to 30	Pierce skin with fork before baking.

Notes:

- The oven temperature indicated in the chart above is recommended over the package instruction temperature.
- The baking time in the chart above is only a guideline for your reference. You need to adjust time according to the food condition or your preference. Check doneness at the minimum time.

MEAT ROASTING GUIDELINES FOR CONVECTION COOKING

Food		Oven Temp.	Time, Min. / lb.
Beef	Ribs (2 to 4 lbs.)		
	Rare	300°F	45 to 50
	Medium	300°F	50 to 55
	Well	300°F	55 to 60
	Boneless Rib, Top Sirloin		
	Rare	300°F	53 to 58
	Medium	300°F	58 to 63
	Well	300°F	63 to 68
	Beef Tenderloin		
	Rare	300°F	28 to 32
Medium	300°F	32 to 36	
Ham	Pot Roast (2 ¹ / ₂ to 3 lbs.)		
	Chuck, Rump	300°F	83 to 88
	Meat Loaf (2 lbs.)	400°F	65 to 75
Ham	Canned (3-lb. fully cooked)	325°F	20 to 25
	Butt (5-lb. fully cooked)	325°F	20 to 25
	Shank (5-lb. fully cooked)	325°F	17 to 20
Lamb	Bone-in (2 to 4 lbs.)		
	Medium	300°F	42 to 47
	Well	300°F	47 to 52
	Boneless (2 to 4 lbs.)		
	Medium	300°F	50 to 55
Well	300°F	55 to 60	
Pork	Bone-in (2 to 4 lbs.)	300°F	48 to 52
	Boneless (2 to 4 lbs.)	300°F	56 to 61
	Pork Chops (1/2 to 1-inch thick)		
	2 chops	325°F	42 to 45
	4 chops	325°F	45 to 48
6 chops	325°F	48 to 55	
Poultry	Whole Chicken (2 ¹ / ₂ to 3 ¹ / ₂ lbs.)	375°F	25 to 35
	Chicken Pieces (2 ¹ / ₂ to 3 ¹ / ₂ lbs.)	425°F	10 to 12
	Duckling (4 to 5 lbs.)	375°F	19 to 21
	Turkey Breast (4 to 6 lbs.)	325°F	21 to 25
Seafood	Fish, whole (3 to 5 lbs.)	400°F	13 to 18
	Lobster Tails (6 to 8-oz. each)	350°F	12 to 17

Note:

- The roasting time in the chart above is only a guideline for your reference. You need to adjust time according to the food condition or your preference. Check doneness at the minimum time.







SPEED AUTO COMBINATION

This oven can cook food without entering cooking time or power level on combination mode. SPEED AUTO COMBINATION has 4 food categories.

See the SPEED AUTO COMBINATION CHART on this page for the settings available.

For best results, place food on the rack. When cooking meats, use the metal tray/drip pan to catch drippings.

Example: To cook 2 lb. roast pork.

Touch:	Display Shows:
1. 	Time of day
2. 	<i>SELECT MENU 1 TO 4</i>
3. 	<i>ROAST PORK</i> <i>ENTER WEIGHT</i>
4.  	<i>2.0 Lbs</i> <i>TOUCH START</i> Time counting down and cook.
5. 	<i>ROAST PORK</i>

SPEED AUTO COMBINATION CHART

TOUCH COMBI PAD	CATEGORY	DIRECTION	AMOUNT
1	Whole Chicken	Thoroughly wash inside and outside of chicken with cold water. Pat chicken dry with paper towels, secure the legs with kitchen twine. Brush outside of chicken with melted butter or margarine. Place chicken breast side down on metal rack on metal tray. After cooking, loosely tent chicken with aluminum foil. Let stand for 10 minutes after cooking.	2.0 - 4.0 lbs
2	Roast Pork	Pat dry with paper towels. Place roast on metal rack on metal tray. After cooking, loosely tent roast with aluminum foil and let stand 5 to 10 minute.	2.0 - 4.0 lbs
3	Frozen Lasagna	Remove from outer package. Remove film cover. If lasagna is not in a ovenproof container, place it on a ovenproof dish. Place on metal rack on metal tray. Let stand for 5 minutes after cooking.	10 or 21 oz.
4	Baked Potato	Pierce each potato several times with a fork and place on metal rack on metal tray.	1 - 4 EA

COMBINATION ROAST COOKING GUIDE

Food		Oven Temp.	Time, Min. / lb.
Beef	Turn over after half of cooking time.		
	Ribs (2 to 4 lbs.)		
	Rare	375°F	9 to 13
	Medium	375°F	11 to 15
	Well	375°F	13 to 17
	Boneless Rib, Top Sirloin		
	Rare	375°F	9 to 13
	Medium	375°F	11 to 15
	Well	375°F	13 to 17
	Beef Tenderloin		
Rare	375°F	16 to 18	
Medium	375°F	18 to 20	
Chuck, Rump or Pot Roast (2½ to 3 lbs.) (Use cooking bag for best results.)	300°F	18 to 20	
Ham	Turn over after half of cooking time.		
	Canned (3-lb. fully cooked)	300°F	15 to 18
	Butt (5-lb. fully cooked)	300°F	15 to 18
	Shank (5-lb. fully cooked)	300°F	15 to 18
Lamb	Turn over after half of cooking time.		
	Bone-in (2 to 4 lbs.)		
	Medium	300°F	13 to 18
	Well	300°F	18 to 23
	Boneless (2 to 4 lbs.)		
	Medium	300°F	14 to 19
Well	300°F	19 to 24	
Pork	Turn over after half of cooking time.		
	Bone-in (2 to 4 lbs.)	300°F	17 to 20
	Boneless (2 to 4 lbs.)	300°F	19 to 22
	Pork Chops (¾ to 1-inch thick)		
	2 chops	350°F	10 to 13
	4 chops	305°F	13 to 16
	6 chops	305°F	16 to 19
Poultry	Turn over after half of cooking time.		
	Whole Chicken (2½ to 6 lbs.)	375°F	15 to 17
	Chicken Pieces (2½ to 6 lbs.)	375°F	15 to 18
	Cornish Hens (untied)		
	Unstuffed	425°F	15 to 18
	Stuffed	375°F	22 to 25
	Duckling	375°F	15 to 18
	Turkey Breast (4 to 6 lbs.)	300°F	11 to 15

COMBINATION ROAST COOKING GUIDE (CONT'D)

Food		Oven Temp.	Time, Min. / lb.
Seafood	Fish 1-lb. fillets	350°F	7 to 10
	Lobster Tails (6 to 8-oz. each)	350°F	10 to 15
	Shrimp (1 to 2 lbs.)	350°F	9 to 14
	Scallops (1 to 2 lbs.)	350°F	8 to 13

Note:

- The roasting time in the chart above is only a guideline for your reference. You need to adjust time according to the food condition or your preference. Check doneness at the minimum time.

COMBINATION BAKE COOKING GUIDE

Food		Oven Temp.	Time, Min.	Comments
Pies, Pastries	Quiche	425°F	15 to 17	Let stand 5 minutes before cutting.
Convenience Foods	Frozen Entree	375°F	39 to 43	Follow package directions for preparation.
	Frozen Pizza Rolls, Egg Rolls	450°F	4 to 6	Follow package directions for preparation.
	Pizza	450°F	23 to 26	Follow package directions for preparation.
Vegetables	Baked Potatoes	450°F	36 to 40	Pierce skin with a fork before baking. Place on rack.

HEATING / REHEATING GUIDE

To heat or reheat successfully in a microwave oven, it is important to follow several guidelines. Measure the amount of food in order to determine the time needed to reheat. Arrange the food in a circular pattern for best results. Room temperature food will heat faster than refrigerated food. Canned foods should be taken out of the can and placed in a microwave-safe container. The food will heat more evenly if covered with a microwave-safe lid or vented plastic wrap. Remove cover carefully to prevent steam burns. Use the following chart as a guide for reheating cooked food.

ITEMS	COOK TIME (AT HIGH)	SPECIAL INSTRUCTIONS
Sliced meat 3 slices (1/4 -inch thick)	1-2 minutes	Place sliced meat on microwavable plate. Cover with plastic wrap and vent. Note:Gravy or sauce helps to keep meat juicy.
Chicken pieces 1 breast 1 leg and thigh	2-3 1/2 minutes 1 1/2-3 minutes	Place chicken pieces on microwavable plate.Cover with plastic wrap and vent.
Fish fillet (6-8 oz.)	2-4 minutes	Place fish on microwavable plate.Cover with plastic wrap and vent.
Lasagna 1 serving (10 1/2 oz.)	4-6 minutes	Place lasagna on microwavable plate.Cover with plastic wrap and vent.
Casserole 1 cup 4 cups	1-3 1/2 minutes 5-8 minutes	COOK covered in microwavable casserole.Stir once halfway through cooking.
Casserole – cream or cheese 1 cup 4 cups	1 1/2-3 minutes 3 1/2-5 1/2 minutes	COOK covered in microwavable casserole.Stir once halfway through cooking.
Sloppy Joe or Barbecued Beef 1 sandwich (1/2 cup meat filling)without bun	1-2 1/2 minutes	Reheat filling and bun separately. Cook filling covered in microwavable casserole.Stir once. Heat bun as directed in chart below.
Mashed potatoes 1 cup 4 cups	1-3 minutes 5-8 minutes	COOK covered in microwavable casserole.Stir once halfway through cooking.
Baked beans 1 cup	1 1/2-3 minutes	COOK covered in microwavable casserole.Stir once halfway through cooking.
Ravioli or pasta in sauce 1 cup 4 cups	2 1/2-4 minutes 7 1/2-11 minutes	COOK covered in microwavable casserole.Stir once halfway through cooking.
Rice 1 cup 4 cups	1 1/2-3 1/2 minutes 4-6 1/2 minutes	COOK covered in microwavable casserole.Stir once halfway through cooking.
Sandwich roll or bun 1 roll	15-30 seconds	Wrap in paper towel and place on glass microwavable rack
Vegetables 1 cup 4 cups	1 1/2-2 1/2 minutes 4-6 minutes	COOK covered in microwavable casserole.Stir once halfway through cooking.
Soup 1 serving (8 oz.)	1 1/2-2 1/2 minutes	COOK covered in microwavable casserole.Stir once halfway through cooking.

FRESH VEGETABLE GUIDE

VEGETABLE	AMOUNT	COOK TIME AT HIGH (MINUTE)	INSTRUCTIONS	STANDING TIME
Artichokes (8 oz.each)	2 medium 4 medium	5-8 10-13	Trim.Add 2 tsp water and 2 tsp juice.Cover.	2-3 minutes
Asparagus, Fresh, Spears	1 lb.	3-6	Add 1/2 cup water.Cover.	2-3 minutes
Beans, Green & Wax	1 lb.	7-11	Add 1/2 cup water in 1 1/2 qt.casserole. Stir halfway through cooking.	2-3 minutes
Beets,Fresh	1 lb.	12-16	Add 1/2 cup water in 1 1/2 qt.covered casserole. Rearrange halfway through cooking.	2-3 minutes
Broccoli,Fresh, Spears	1 lb.	4-8	Place broccoli in baking dish. Add 1/2 cup water.	2-3 minutes
Cabbage, Fresh, Chopped	1 lb.	4-7	Add 1/2 cup water in 1 1/2 qt. covered casserole. Stir halfway through cooking.	2-3 minutes
Carrots, Fresh, Sliced	2 cups	2-4	Add 1/4 cup water in 1 qt. covered casserole. Stir halfway through cooking.	2-3 minutes
Cauliflower, Fresh, Whole	1 lb.	7-11	Trim.Add 1/4 cup water in 1 qt. covered casserole. Stir halfway through cooking.	2-3 minutes
Flowerettes, Fresh Celery, Fresh, Sliced	2 cups 4 cups	2 1/2-4 1/2 6-8	Slice.Add 1/2 cup water in 1 1/2 qt. covered casserole. Stir halfway through cooking.	2-3 minutes
Corn, Fresh	2 ears	5-9	Husk.Add 2 tbsp water in 1 1/2 qt.baking dish. Cover.	2-3 minutes
Mushrooms, Fresh, Sliced	1/2 lb.	2-3 1/2	Place mushrooms in 1 1/2 qt.covered casserole.Stir halfway through cooking.	2-3 minutes
Parsnips, Fresh, Sliced	1 lb.	4-8	Add 1/2 cup water in 1 1/2 qt.covered casserole.Stir halfway through cooking.	2-3 minutes
Peas, Green, Fresh	4 cups	7-10	Add 1/2 cup water in 1 1/2 qt.covered casserole.Stir halfway through cooking.	2-3 minutes
Sweet Potatoes Whole Baking (6-8 oz.each)	2 medium 4 medium	5-10 7-13	Pierce potatoes several times with fork. Place on 2 paper towels. Turn over halfway through cooking.	2-3 minutes 2-3 minutes
White Potatoes, Whole Baking (6-8 oz.each)	2 potatoes 4 potatoes	5-8 10-14	Pierce potatoes several times with fork. Place on 2 paper towels. Turn over halfway through cooking.	2-3 minutes 2-3 minutes
Spinach, Fresh, Leaf	1 lb.	4-7	Add 1/2 cup water in 2 qt.covered casserole.	2-3 minutes
Squash, Acorn or Butternut, Fresh	1 medium	6-8	Cut squash in half.Remove seeds. Place in 8 x 8-inch baking dish. Cover.	2-3 minutes
Zucchini, Fresh, Sliced	1 lb.	4 1/2-7 1/2	Add 1/2 cup water in 1 1/2 qt.covered casserole. Stir halfway through cooking.	2-3 minutes
Zucchini, Fresh, Whole	1 lb.	6-9	Pierce. Place on 2 paper towels. Turn over and rearrange halfway through cooking.	2-3 minutes

Caring for Your Microwave Oven

To make sure your microwave oven looks good and works well for a long time, you should maintain it properly. For proper care, please follow these instructions carefully.

For interior surfaces: Wash often with warm, sudsy water and a sponge or soft cloth. **Use** only mild, nonabrasive soaps or a mild detergent. **Be sure to keep the areas clean where the door and oven frame touch when closed.** Wipe well with clean cloth.

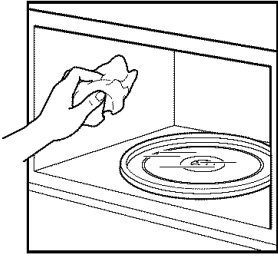

Over time, stains can occur on the surfaces as the result of food particles spattering during cooking. This is normal.

For stubborn soil, boil a cup of water in the oven for 2 to 3 minutes. Steam will soften the soil. To get rid of odors inside the oven, boil a cup of water with some lemon juice or vinegar in it.

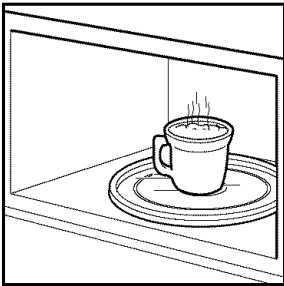

For exterior surfaces and control panel: Use a soft cloth with spray glass cleaner. Apply the spray glass cleaner to the soft cloth; do not spray directly on the oven.

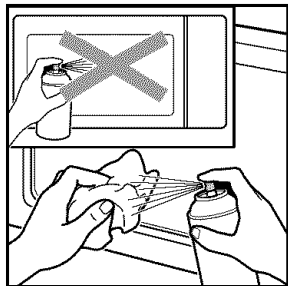

NOTE: Abrasive cleansers, steel wool pads, gritty wash cloths, some paper towels, etc., can

damage the control panel and the interior and exterior oven surfaces.

To clean glass tray and rotating ring, wash in mild,

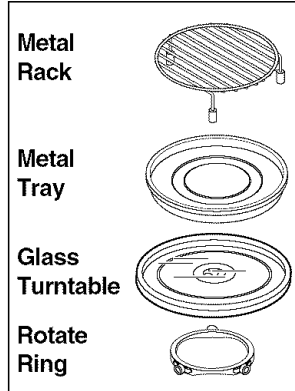

sudsy water; for heavily soiled areas **use** a mild cleanser and scouring sponge. The glass tray and rotating ring are dishwasher safe.

CARING FOR THE FILTERS

The grease filters should be removed and cleaned often, at least once a month.

NOTE: If your microwave hood combination is installed to recirculate air, the charcoal filter (Part No.5230W1A003A) is available from Sears by calling 1-800-4-MY-HOME®.

The charcoal filter cannot be cleaned and should be replaced every 6 to 12 months.

Grease filters (Part No.2B72705C):

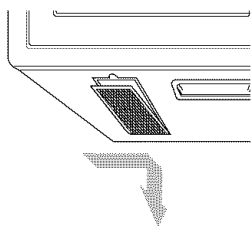

1. Unplug microwave oven or disconnect power.

2. To remove grease filters, slide each filter to the side. Pull filters downward and push to the other side. The filter will drop out.

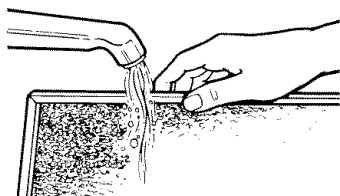

3. Soak grease filters in hot water and a mild detergent. Scrub and swish to remove embedded dirt and grease. Rinse well and shake to dry. Do not clean filters with ammonia, corrosive cleaning agents such as lye-based oven cleaners, or place them in a dishwasher. The filters will turn black or could be damaged.

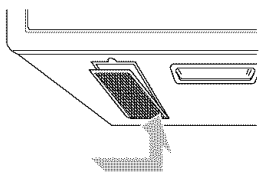

4. To replace grease filters, slide filter in the frame slot on one side of the opening. Push filter upward and push to the other side to lock into place.

5. Plug in microwave oven or reconnect power.

CHARCOAL FILTER REPLACEMENT

If your oven is vented inside, the charcoal filter should be replaced every 6 to 12 months, and more often if necessary. The charcoal filter cannot be cleaned. To order a new charcoal filter, see information in NOTE above.

1. **Disconnect** power or **unplug** microwave oven.
2. **Remove** the two vent grille mounting screws.

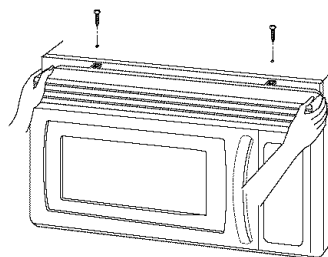

3. **Tip** the grille forward, then lift out to remove.
4. Remove bulb holder

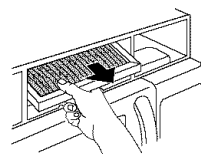

5. **Slide** a new charcoal filter into place. The filter should rest at the angle shown.

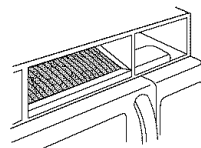

6. **Slide** the bottom of the vent grille into place. **Push** the top until it snaps into place. **Replace** the mounting screws.
7. **Reconnect** power or **plug** in microwave oven.

REPLACING THE COOKTOP AND OVEN LIGHTS

The cooktop light

1. Unplug microwave oven or disconnect power.

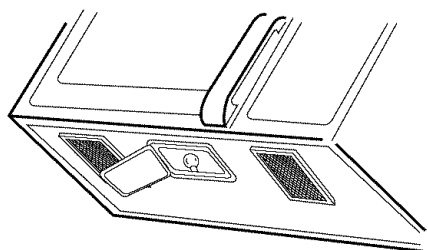

2. Remove the bulb cover mounting screws.

3. Replace bulb with 35-watt bulb.

4. Plug in microwave oven or reconnect power.

4. Lift up the bulb holder.

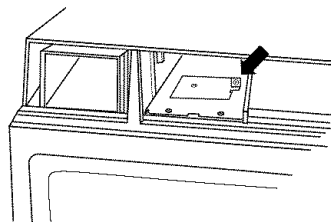

5. Remove the bulb holder.

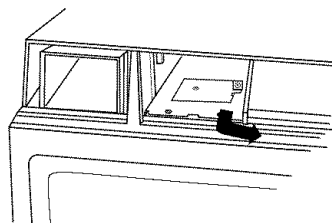

6. Replace the bulb with a 35-watt bulb.

7. Replace the bulb holder.

The oven light

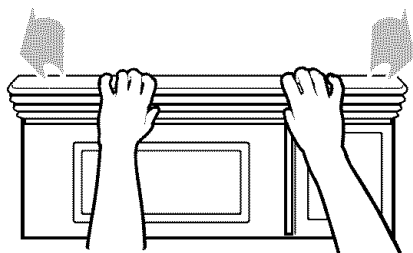

1. Unplug microwave oven or disconnect power.

2. Remove the vent grille mounting screws.

3. Tip the grille forward, then lift out to remove.

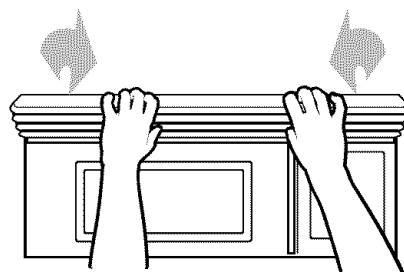

8. Slide the top of the vent grille into place. Push the bottom until it snaps into place. Replace the mounting screws.

9. Plug in microwave oven or reconnect power.

Questions and Answers

QUESTIONS	ANSWERS
Can I operate my microwave oven without the glass tray or move the glass tray over to hold a large dish?	No. If you remove or move the glass tray, you will get poor cooking results. Dishes used in your oven must fit on the glass tray.
Can I use either metal or aluminum pans in my microwave oven?	You can not use metal pans. You can use aluminum foil for shielding (use small, flat pieces), small skewers, and shallow foil trays (if tray is not taller than 3/4 in. [1.9 cm] deep and is filled with food to absorb microwave energy). Never allow metal to touch walls or door.
Sometimes the door of my microwave oven appears wavy. Is this normal?	This appearance is normal and does not affect the operation of your oven.
Why does the dish become hot when I microwave food in it? I thought that this should not happen.	As the food becomes hot it will conduct the heat to the dish. Be prepared to use hot pads to remove food after cooking.
What does "standing time" mean?	Standing time means that food should be allowed to stand either in or out of oven after cooking power stops. Standing time allows heat to spread evenly throughout the food, improving cooking results.
Why does steam come out of the air exhaust vent?	Steam is normally produced during cooking. The microwave oven has been designed to vent this steam out the vents.
Can I pop popcorn in my microwave oven?	Yes, but only pop pre-packaged microwave popcorn, and only use the Popcorn command pad. Do not pop popcorn in any other form or by any other method."

Troubleshooting

Most cooking problems often are caused by little things you can find and fix without tools of any kind. Check the lists below and on the next page before calling for assistance or service. If you still need help, call SEARS PARTS & REPAIR at 1-800-4-MY-HOME®.

MICROWAVE OVEN DOES NOT WORK

PROBLEM	CAUSE
Nothing works.	<ul style="list-style-type: none">• The power supply cord is not plugged into a grounded 3 prong outlet. (See the “Electrical Requirements” section on page 5 and the “Electrical connection” section on Page 7.)• A household fuse has blown or a circuit breaker has tripped.• The electric company has had a power failure.
The microwave oven will not run.	<ul style="list-style-type: none">• You are using the oven as a timer. Touch STOP/CLEAR to cancel the Kitchen Timer.• The door is not firmly closed and latched.• You did not touch START/ENTER.• You did not follow directions exactly.• An operation that you set earlier is still running. Touch STOP/CLEAR to cancel that operation.

COOKING TIMES

PROBLEM	CAUSE
Food is not cooked enough.	<ul style="list-style-type: none">• The cook power is not at the recommended setting. Check the table on Page 19.• The electric supply to your home or wall outlets is low or lower than normal. Your electric company can tell you if the line voltage is low. Your electrician or service technician can tell you if the outlet voltage is low.
The display shows a time counting down but the oven is not cooking.	<ul style="list-style-type: none">• The oven door is not closed completely.• You have set the controls as a kitchen timer. Touch STOP/CLEAR pad and cancel Kitchen Timer.

GLASS TRAY

PROBLEM	CAUSE
The glass tray will not move.	<ul style="list-style-type: none"> • The glass tray is not correctly in place. It should be correct-side up and sitting firmly on the center hub. • The support is not operating correctly. Remove the glass tray and restart the oven. If the hub still does not move, call Sears Service at 1-800-4-MY-HOME®. Cooking without the glass tray can give you poor results.

TONES

PROBLEM	CAUSE
You do not hear the programming or end-of-cycle tone.	<ul style="list-style-type: none"> • You have not entered the correct command.

DISPLAY MESSAGES

PROBLEM	CAUSE
The display is flashing “:”.	<ul style="list-style-type: none"> • There has been a power interruption. Reset the clock. (See the “Clock” section on Page 16.)

If none of these items are causing your problem, call Sears Service at 1-800-4-MY-HOME®.