

SENCOR®

STL 201



EN	LED table lamp with clock USER MANUAL Thank you for purchasing our products Please read the manual carefully before operation, also keep it property.	1
CZ	Stolní LED lampa s hodinami UŽIVATELSKÁ PŘÍRUČKA Děkujeme vám za zakoupení tohoto produktu. Před jeho použitím si prosím pozorně přečtete tento návod a dobře jej uschovejte.	8
SK	Stolová LED lampa s hodinami UŽIVATELSKÁ PŘÍRUČKA Ďakujeme vám za kúpu tohto produktu. Pred jeho použitím si, prosím, pozorne prečítajte tento návod a dobre ho uschovajte.	15
HU	Asztali LED-lámpa órával FELHASZNÁLÓI KÉZIKÖNYV Köszönjük, hogy megvásárolja a termékét. Használatá elótt kérjük, figyelmesen olvassa el ezt az útmutatót és őrizze meg a későbbiekre.	22
PL	Lampka stołowa LED z zegarem INSTRUKCJA OBSŁUGI Dziękujemy za zakupienie tego produktu. Przed jego użyciem prosimy o dokładne zapoznanie się się z niniejszą instrukcją oraz zachowanie jej do użytku w przyszłości.	30

COMPONENTS & INSTALLATION

ASSEMBLY

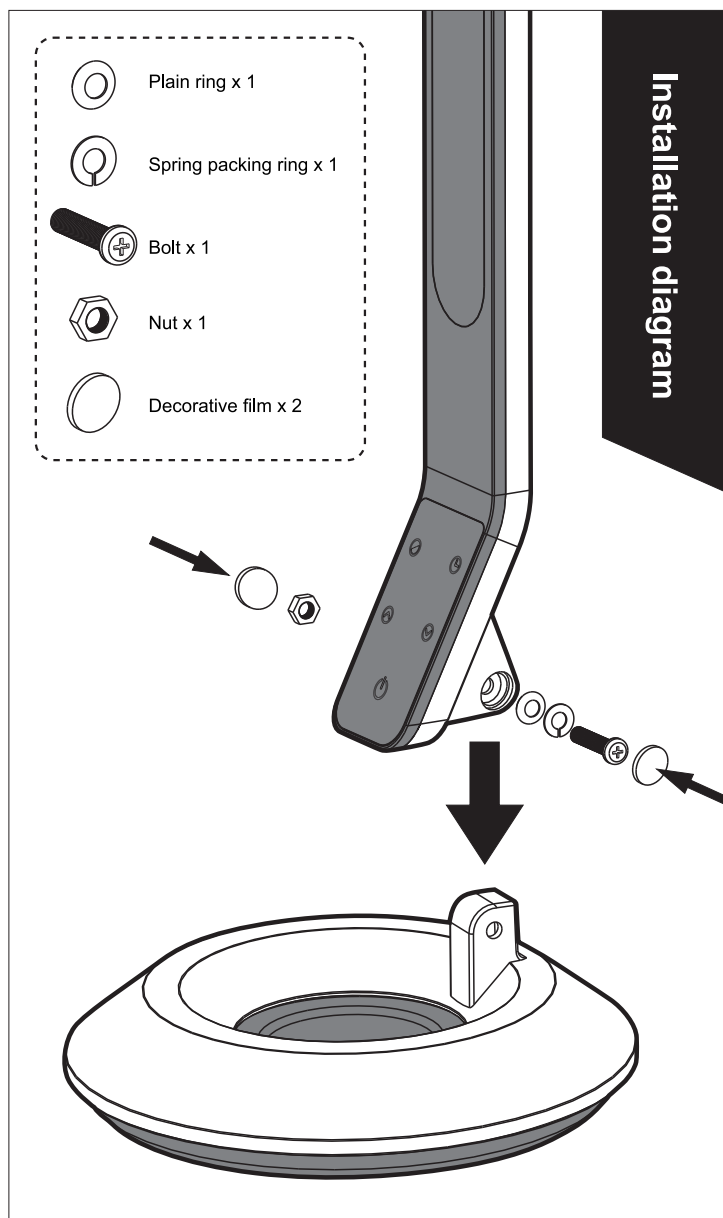

- 9.5W high power LED panel light source



- Please use the enclosed DC adaptor, insert the DC plug into the DC jack at the lamp back

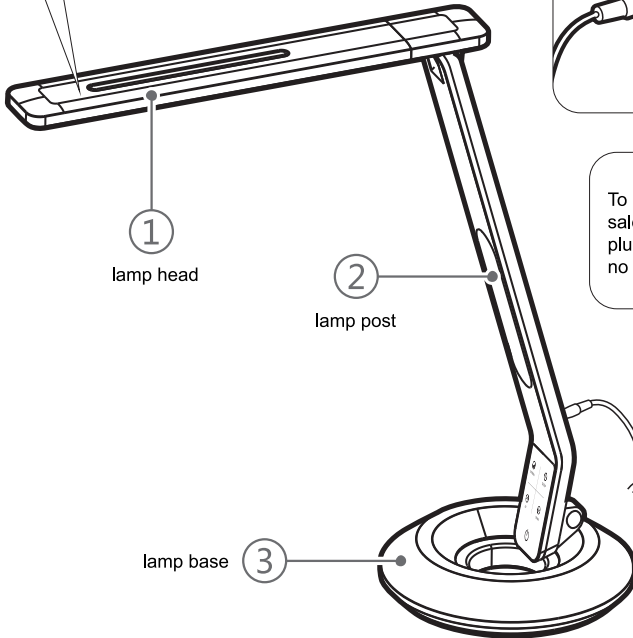
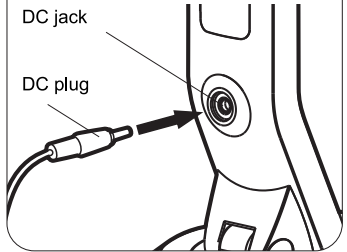

To save energy and make more sale, please draw out the DC plug from the socket if long time no use

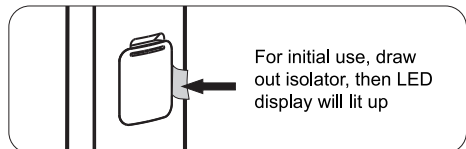
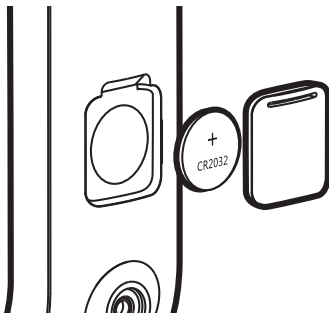
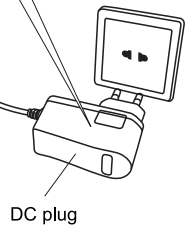

For initial use, draw out isolator, then LED display will lit up

If the adaptor is connected well, but there is no time memory, please replace the CR2032 cell battery

- The battery keeps clock normal working only under the disconnect power situation
- Twist off screw and remove the battery door, put cell battery inside with positive pole upwards and screw up the battery door.

ANGLE ADJUSTMENT

Lamp head angle adjustment

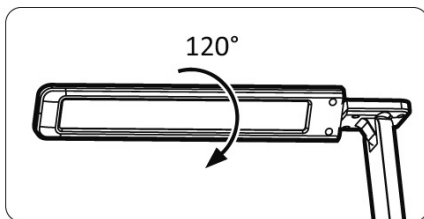
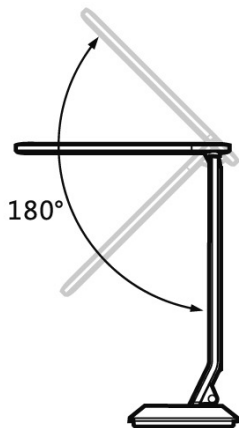

Lamp head angle adjustment

- When adjust the lamp head angle, press the lamp base together
- Lamp head angle adjustment 180° vertically (over adjustment will damage the link parts easily)
- Lamp head rotation with angle 120°

Lamp post angle adjustment

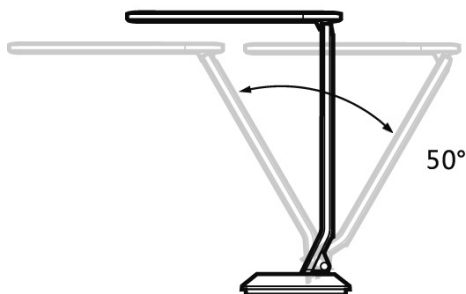

Lamp post angle adjustment

- Lamp post with 50° front-back rotation
- Once the rotation joint becomes loose, please screw it up

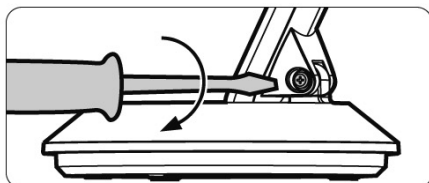

Lamp post left-right rotate angle

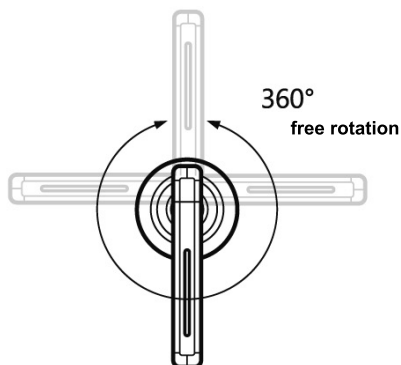

Lamp post angle adjustment

- The lamp base with 360° rotation freely, push it with your fingertip lightly

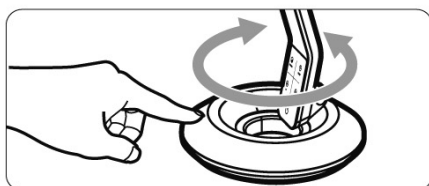

CLOCK AND ALARM SETTING





1. Clock setting

At normal time mode, press SET key one time, Hour position flash, press UP key to adjust upwards, press it long to adjust fast; press DOWN key adjust downwards, press it long to adjust fast. Press SET key again, Minute position flash, press UP key to adjust upwards, press it long to adjust fast; press DOWN key to adjust downwards, press it long to adjust fast. Press SET key again to confirm the settings and come back to normal time mode.

Remark: at clock setting mode, non pressing within 15 seconds or press MODE key to return to normal time mode.

2. Alarm setting

1. At normal time mode, press MODE key to enter into alarm setting mode,  mark will lit up.
2. Press SET key one time, Hour position flash, press UP key to adjust upwards, press it long to adjust fast; press DOWN key adjust downwards, press it long to adjust fast. Press SET key again, Minute position flash, press UP key to adjust upwards, press it long to adjust fast; press DOWN key to adjust downwards, press it long to adjust fast. Press MODE key again to confirm the settings and come back to normal time mode.
3. When arrive at alarm time, buzzer will ring for 1 minue with  mark flashing.

Remark: at alarm setting mode, non pressing within 15 seconds or press MODE key to return to normal time mode.

3. Shortcut keys

1. At normal time mode, press UP key to activate or deactivate alarm function. When activate alarm,  will lit up. Only when the alarm function is activated, alarm will work when arrive at alarm setting time.
2. At normal time mode, press DOWN key to change 12H/24H
3. When alarm is ringing, press any key to stop it

TABLE LAMP OPERATION







 SCREEN  SLEEP

 UP  DOWN



● On/off and brightness adjust

1. Press  key to turn on or turn off the lamp
2. After turn it on, press   to adjust the brightness, brightness level will display in the middle circle and the round dial. Level from 10 to 99 (10 is the lowest brightness, 99 is the highest brightness)
3. Sleep function; press  key,  mark will display, press it again, it will display:

10 minutes - 30 minutes - 60 minutes - 90 minutes (00 means shut off)

After select the sleep time, countdown timing will be started, after arrive at 00, the lamp will shut off automatically. So this function can avoid forgetting to turn lamp off before sleep.

● Screen brightness adjust

Press  key to adjust screen brightness, open (top bright) - half bright - close, repeat like this.

TECHNICAL SPECIFICATIONS:

- Panel consisting of 48 LEDs
- Power output: 9.5W Max
- Number of lumens: 300 lm
- Colour temperature of light: 5000-5500 K
- CRI (colour rendering index): >70
- Clock and alarm
- Brightness control: from 10 to 99
- Automatic lamp shut off option setting - Sleep (10,30,60 and 90 minutes)
- Option to disable the clock display
- Option to set the head angle in a 180° range
- Head rotation up to 120°
- Lamp arm angle setting forward and back in a 50° range
- Lamp arm rotation left-right at an angle of 360°
- Backup clock battery CR2032 (included)
- LED lifetime up to 50,000 hours
- Power source: DC 12V/1000mA
- Dimensions: 170 x 170 x 450 mm
- Weight: 1.2 kg
- Power input: max 12 W

INSTRUCTIONS AND INFORMATION REGARDING THE DISPOSAL OF USED PACKAGING MATERIALS

Dispose of packaging material at a public waste disposal site.

DISPOSAL OF USED ELECTRICAL AND ELECTRONIC APPLIANCES



The meaning of the symbol on the product, its accessory or packaging indicates that this product shall not be treated as household waste. Please, dispose of this product at your applicable collection point for the recycling of electrical & electronic equipment waste. Alternatively in some states of the European Union or other European states you may return your products to your local retailer when buying an equivalent new product. The correct disposal of this product will help save valuable natural resources and help in preventing the potential negative impact on the environment and human health, which could be caused as a result of improper liquidation of waste. Please ask your local authorities or the nearest waste collection centre for further details. The improper disposal of this type of waste may fall subject to national regulations for fi nes.

For business entities in the European Union

If you wish to dispose of an electrical or electronic device, request the necessary information from your seller or supplier.

Disposal in other countries outside the European Union

If you wish to dispose of this product, request the necessary information about the correct disposal method from local government departments or from your seller.



This product meets all the basic EU regulation requirements that relate to it.

Changes to the text, design and technical specifications may occur without prior notice and we reserve the right to make these changes.

SENCOR®

EN Warranty conditions

Warranty card is not a part of the device packaging.

This product is warranted for the period of 24 months from the date of purchase to the end-user. Warranty is limited to the following conditions. Warranty is referred only to the customer goods using for common domestic use. The claim for service can be applied either at dealer's shop where the product was bought, or at below mentioned authorized service shops. The end-user is obligated to set up a claim immediately when the defects appeared but only till the end of warranty period. The end user is obligated to cooperate to certify the claiming defects. Only completed and clean (according to hygienic standards) product will be accepted. In case of eligible warranty claim the warranty period will be prolonged by the period from the date of claim application till the date of taking over the product by end-user, or the date the end-user is obligated to take it over. To obtain the service under this warranty, end-user is obligated to certify his claim with duly completed following documents: receipt, certificate of warranty, certificate of installation.

This warranty is void especially if apply as follows:

- Defects which were put on sale.
- Wear-out or damage caused by common use.
- The product was damaged by unprofessional or wrong installation, used in contrary to the applicable instruction manual, used in contrary to legal enactment and common process of use or used for another purpose which has been designed for.
- The product was damaged by uncared-for or insufficient maintenance.
- The product was damaged by dirt, accident of force majeure (natural disaster, fire, and flood).
- Defects on functionality caused by low duality of signal, electromagnetic field interference etc.
- The product was mechanically damaged (e.g. broken button, fall).
- Damage caused by use of unsuitable media, fillings, expendable supplies (batteries) or by unsuitable working conditions (e.g. high temperatures, high humidity, quakes).
- Repair, modification or other failure action to the product by unauthorized person.
- End-user did not prove enough his right to claim (time and place of purchase).
- Data on presented documents differs from data on products.
- Cases when the claiming product cannot be indentified according to the presented documents (e.g. the serial number or the warranty seal has been damaged).

Authorized service centers

Visit www.sencor.eu for detailed information about authorized service centers.