

Operating instructions Coffee maker



To avoid the risk of accidents or damage to the appliance, it is **essential** to read these instructions before it is installed and used for the first time.

Caring for the environment

Packaging material

The packaging material used protects the machine during transportation. Please retain the original box and polystyrene pieces so that you can pack the machine securely, should you need to transport it in the future.

The original packaging should also be kept in case the machine ever needs to be returned to Miele for servicing.

Disposing of your old appliance

Electrical and electronic appliances often contain valuable materials. They also contain specific materials, compounds and components, which were essential for their correct function and safety. These could be hazardous to human health and to the environment if disposed of with your domestic waste or if handled incorrectly. Please do not, therefore, dispose of your old appliance with your household waste.



Please dispose of it at your local community waste collection / recycling centre for electrical and electronic appliances. You are also responsible for deleting any personal data that may be stored on the appliance prior to disposal. Please ensure that your old appliance poses no risk to children while being stored prior to disposal.

Caring for the environment	2
Warning and Safety instructions	6
Guide to the appliance	16
Controls and display	17
Accessories	18
Operating principles	19
Before using for the first time	20
Water hardness	22
Filling the water container	23
Filling the coffee bean container	24
Switching on and off	25
Adjusting the central spout to the correct cup height	26
Making drinks	27
Making coffee drinks with and without milk	27
Preparing hot milk	27
Using milk cartons or bottles	28
Making a coffee drink	28
Cancelling preparation	28
2 portions (☐ sensor control)	29
Coffee pot	29
Making drinks with ready ground coffee	29
Adding ready ground coffee	30
Dispensing hot water (CM 5410, CM 5510, CM 5710)	31
Grinder setting	32
Amount of coffee, brew temperature and pre-brewing	33
Amount of coffee	33
Brewing temperature	33
Pre-brewing ground coffee	33
Portion size	34
User profiles	36
Creating profiles	36

Contents

Changing drinks in a profile.....	36
Preparing User profile drinks.....	36
Changing a User profile name.....	36
Deleting a profile	36
Setting when the profile should change (Change profile)	37
Settings	38
Displaying and changing Settings.....	38
Language.....	38
Timer: switch off after.....	38
Eco mode	38
Info (display information)	38
System lock 	38
Water hardness	38
Display brightness.....	38
Volume.....	38
Factory default settings	38
Demo mode (showroom programme)	39
Cleaning and care	40
Cleaning intervals - Quick guide	40
Cleaning by hand or in the dishwasher	41
Unsuitable cleaning agents	42
Waste container, drip tray and drip tray cover	43
Cleaning the water container	44
Removing and cleaning the water container filter	44
Central spout.....	45
Milk pipework	47
Bean container and ground coffee chute	47
Cleaning the housing.....	48
Opening the Maintenance menu	48
Rinsing the appliance	48
Rinsing the milk pipework	48
Degreasing the brew unit and cleaning the interior.....	50
Descaling the appliance	53
Transporting the machine	55
Evaporating the coffee machine.....	55
Packing.....	55
Problem solving guide	56
Messages in the display	56
Unusual performance of the coffee machine	59
Unsatisfactory results.....	65

After sales service and warranty	67
Contact in case of fault	67
Warranty	67
Saving energy	68
Electrical connection	69
Installation	70
Appliance dimensions	71
Technical data	72

Warning and Safety instructions

This coffee machine complies with all current local and national safety requirements. However, inappropriate use can lead to personal injury and damage to property.

Read the operating instructions carefully before using the coffee machine. They contain important information on the installation, safety, use and maintenance of the appliance. Familiarity with these instructions will help to prevent personal injury and damage to property.

In accordance with standard IEC 60335-1, Miele expressly and strongly advises that you read and follow the instructions in "Installation", "Electrical connection", as well as in the "Warning and Safety instructions".

Miele cannot be held liable for injury or damage caused by non-compliance with these instructions.

Keep these instructions in a safe place and pass them on to any future owner.

Correct application

- ▶ The coffee machine is intended for use in private households.
- ▶ The coffee machine is not suitable for outdoor use.
- ▶ This coffee machine must not be used at altitudes above 2,000 m.
- ▶ The machine is intended only for the preparation of coffee based drinks such as espresso, cappuccino, latte macchiato etc. Any other usage is at the owner's risk.
- ▶ This appliance is not intended for use by persons (including children) with reduced physical, sensory or mental capabilities, or lack of experience and knowledge, unless they have been given supervision or instruction concerning its use by a person responsible for their safety, and are able to recognise the dangers of misuse.

Warning and Safety instructions

Safety with children

 Danger of burning and scalding on the dispensing spouts. Children's skin is far more sensitive to high temperatures than that of adults. Ensure children do not touch hot surfaces of the coffee machine or place parts of their body under the dispensing spouts.

- ▶ Install the coffee machine out of reach of children.
- ▶ Young children must be kept away from the coffee machine and the mains connection cable and plug/socket.
- ▶ Older children may only use the coffee machine if its operation has been clearly explained to them and they are able to use it safely. They must be aware of the potential dangers caused by incorrect operation.
- ▶ Children should be supervised when they are near the coffee machine. Do not allow them to play with it or to use the controls.
- ▶ Young children must not be allowed to clean the coffee machine. Cleaning may only be carried out by older children under the supervision of an adult.
- ▶ Remember that coffee and espresso are not suitable drinks for children.
- ▶ Danger of suffocation! Whilst playing, children may become entangled in packaging material (such as plastic wrapping) or pull the packaging material over their head, presenting the risk of suffocation. Keep packaging material away from children.

Technical safety

- ▶ A damaged coffee machine is dangerous. Check it for any visible damage before setting it up. Never attempt to use a damaged coffee machine.
- ▶ Before connecting the appliance to the mains supply, make sure that the rating on the data plate corresponds to the voltage and frequency of the household supply. This data must correspond in order to avoid the risk of damage to the appliance. Consult a qualified electrician if in any doubt.
- ▶ The electrical safety of this appliance can only be guaranteed when continuity is complete between it and an effective earthing system. It is most important that this basic safety requirement is present and tested regularly and, where there is any doubt, the household wiring system should be inspected by a qualified electrician.
- ▶ Reliable and safe operation of the coffee machine can only be guaranteed if it is connected to the mains electrical supply.
- ▶ Do not connect the machine to the mains electricity supply by a multi-socket adapter or an extension lead. These do not guarantee the safety of the appliance (e.g. danger of overheating).
- ▶ This appliance must not be installed and operated in mobile installations (e.g. on a ship).
- ▶ Unplug the coffee machine from the power supply immediately if you notice any damage or smell scorching, for example.
- ▶ Ensure that the mains connection cable cannot be pinched or damaged by any sharp edges.
- ▶ The mains connection cable should not hang down. Someone could trip over it with the risk of injury and the machine could be damaged.

Warning and Safety instructions

- ▶ Only use the coffee machine in rooms where the ambient temperature is between +10 °C and +38 °C.
- ▶ Position the coffee machine at a height of at least 850 mm from the floor.
- ▶ Danger of overheating! Ensure that there is sufficient ventilation around the coffee machine. Do not cover the coffee machine with tea towels etc. while it is in use.
- ▶ If the coffee machine is installed behind a kitchen furniture door, it may only be used with the furniture door open. This will prevent the formation of heat and humidity and subsequent damage to the appliance and/or furniture unit. Do not close the furniture door while the coffee machine is in use. Ensure the coffee machine has cooled down completely before closing the furniture door.
- ▶ Protect the coffee machine from water and water spray. Do not immerse the machine in water.
- ▶ Repairs and other work by unqualified persons to the machine and the connection cable could be dangerous. The manufacturer cannot be held liable for unauthorised work. Repairs may only be carried out by a Miele authorised service technician.
- ▶ The manufacturer's warranty will be invalidated if the appliance is not repaired by a Miele approved service technician.
- ▶ Miele can only guarantee the safety of the appliance when original Miele spare parts are used. Faulty components must only be replaced by original Miele spare parts.

Warning and Safety instructions

- ▶ Before any repair work is carried out, the appliance must be completely disconnected from the electricity supply. The appliance is only completely isolated from the electricity supply when:
 - it is switched off at the wall socket and the plug is withdrawn from the socket. Do not pull the mains connection cable but the mains plug to disconnect your appliance from the mains electricity supply.
 - the mains circuit breaker is switched off.
- ▶ Never open the outer casing of the machine. Tampering with electrical connections or components and mechanical parts is highly dangerous to the user and can cause operational faults or electric shock.
- ▶ Only use original Miele spare parts and accessories. If other spare parts and accessories are used, warranty, performance and/or product liability claims will be invalidated.

Warning and Safety instructions

Correct use

 Danger of burning and scalding on the dispensing spouts. The liquids and steam dispensed are very hot. Heating surfaces have residual heat after use.

Keep well away from the area underneath the spouts when hot liquids and steam are being dispensed.

Do not touch hot components.

Hot liquid or steam could spatter from the spouts. Ensure that the central spout is clean and fitted correctly.

Water in the drip tray can also be very hot. Take care when emptying it.

▶ Please note the following regarding water:

- The water quality must conform to the requirements for drinking water in the country in which the coffee machine is being used.
- Only use cold, fresh tap water to fill the water container. Hot or warm water or other liquids can damage the coffee machine.
- Change the water every day to prevent a build-up of bacteria.
- Do not use carbonated water.

▶ Only fill the bean container with roasted espresso or coffee beans. Do not fill the bean container with coffee beans which have been treated, e.g. flavoured or caramelised, or with ground coffee.

▶ Do not fill the bean container with any type of liquid.

▶ Do not use green (unroasted) coffee beans or mixtures of coffee beans which contain green coffee beans. Green coffee beans are very hard and still contain residual moisture. These can damage the coffee machine grinder as soon as grinding begins.

▶ Do not use coffee beans which have been treated with caramel, sugar or other substances. Sugar will damage the coffee machine.

▶ Only fill the coffee chute with ground coffee beans.

Warning and Safety instructions

- ▶ Do not use any caramelised ready ground coffee. The sugar in the coffee will stick to and block the brew unit of the coffee machine. The cleaning tablets for degreasing the brew unit will not remove this type of deposit.
- ▶ Only use milk without additives. Additives in milk usually contain sugar and this will stick to the milk pipework.
- ▶ If using cow's milk, only use pasteurised milk to prevent a build-up of bacteria in the appliance.
- ▶ Do not place flaming alcohol mixtures underneath the central spout. The flames could ignite plastic components and cause them to melt.
- ▶ Do not use naked flames, e.g. a candle, on or near the coffee machine. The coffee machine could catch fire with the risk of the fire spreading.
- ▶ The machine must not be used for cleaning objects.

Warning and Safety instructions

Cleaning and care

- ▶ Disconnect the coffee machine from the power supply before cleaning.
- ▶ Clean the coffee machine daily, particularly before using it for the first time (see “Cleaning and care”).
- ▶ All parts of the milk system need to be cleaned thoroughly and regularly. Milk contains bacteria which proliferate rapidly with inadequate cleaning.
- ▶ Do not clean the machine with a steam cleaner or immerse it in water as this will damage the machine. Steam or water could reach the electrical components and cause a short circuit.
- ▶ Avoid spillage on appliance connectors.
- ▶ Descale the coffee machine regularly depending on the water hardness level in your area. Descale the machine more frequently in areas with very hard water. Miele cannot be held liable for damage arising from insufficient descaling, the use of incorrect descaling agents or the use of a descaling agent which is not of the appropriate concentration.
- ▶ Degrease the brew unit regularly with Miele cleaning tablets. Depending on the natural oil content of the coffee used, the brew unit can become blocked quite quickly.
- ▶ Used coffee grounds should be disposed of with the organic rubbish or on the compost heap. Do not empty them down the sink, as they could block it.

The following applies to appliances with stainless steel surfaces:





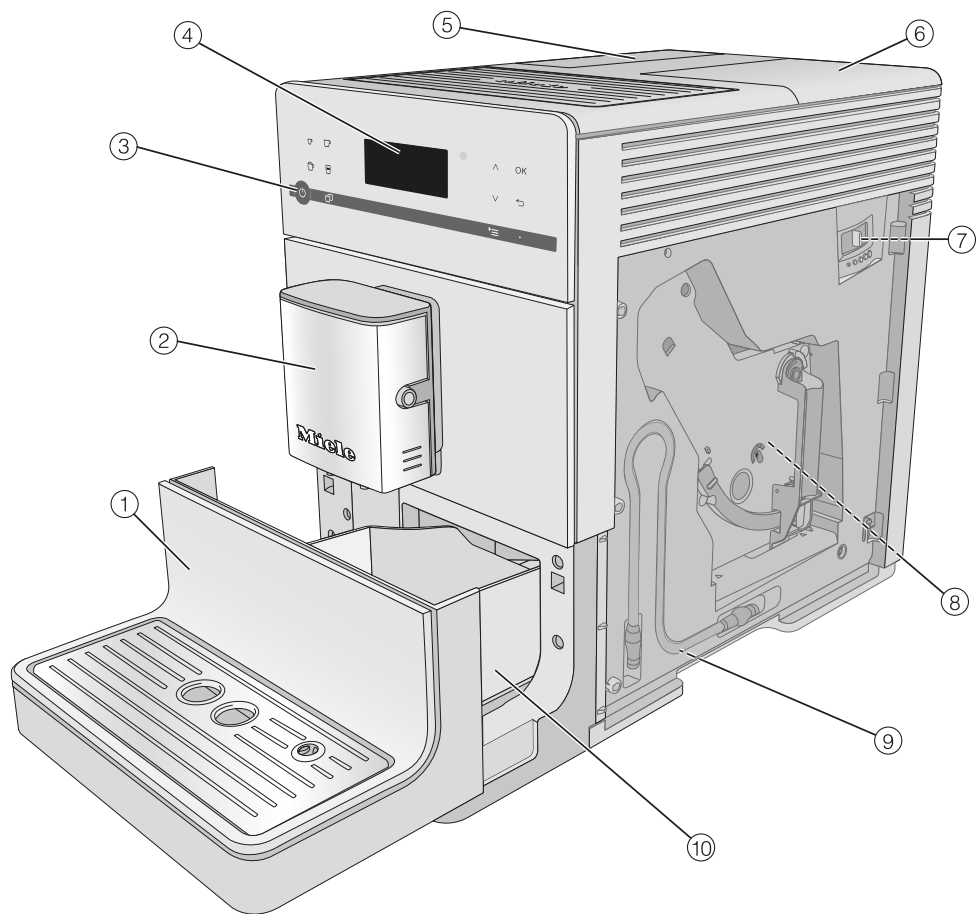

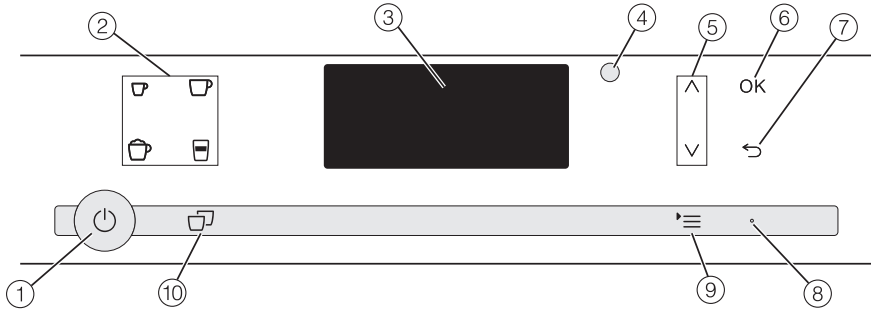

- ▶ Do not adhere stickers, adhesive tape or any other adhesive materials to the stainless steel surfaces.
- ▶ Stainless steel scratches very easily and even magnets can cause damage to the surface.

Guide to the appliance



- ① Lower panel with drip tray cover
- ② Central spout with cappuccinatore and hot water spout
- ③ On/Off  sensor
- ④ Control panel
- ⑤ Water container
- ⑥ Bean container and ground coffee chute
- ⑦ Grinder setting (behind the appliance door)
- ⑧ Brew unit (behind the appliance door)
- ⑨ Park position for milk tube (behind the appliance door)
- ⑩ Drip tray with lid and waste container



- ① **On/Off**  **sensor**
For switching the coffee machine on and off
- ② **Drink sensors**
For making drinks
 -  Espresso
 -  Coffee
 -  Cappuccino
 -  Latte macchiato
- ③ **Display**
For showing information about the current action or status
- ④ **Optical interface**
(for Miele service technicians only)
- ⑤ **^v sensor controls**
For scrolling through lists of options, highlighting a selection or changing values
- ⑥ **OK sensor**
For confirming display messages and saving settings
- ⑦ **“Back”**  **sensor**
For going back a menu level and cancelling unwanted actions
- ⑧ **LED**
Flashes when the appliance is switched on and the display is in energy saving mode
- ⑨ **☰ sensor**
Other drinks
User profiles (CM 5410, CM 5510, CM 5710)
Maintenance
Parameters
Settings 
- ⑩ **“2 portions”**  **sensor**
For dispensing two portions of a drink at the same time

Accessories

These products and other useful accessories can be ordered via the Miele webshop or directly from Miele (see back cover for contact details).

Accessories supplied

- **Starter set “Miele appliance care”**
Various cleaning products are supplied depending on model.
- **Cleaning brush**
For cleaning the milk pipework

Optional accessories

Miele accessories and cleaning and conditioning products are available for your coffee machine.

- **Original Miele all purpose microfibre cloth**
For removing finger marks and light soiling
- **Cleaning agent for milk pipework**
For cleaning the milk system
- **Cleaning tablets**
For degreasing the brew unit
- **Descaling tablets**
For descaling the water pipework
- **Milk flask with lid**
For storing and preparing milk

Sensor controls

To operate the coffee machine, touch the sensors with your finger.

An audible signal is generated each time a sensor is touched. You can adjust the volume of the signal tones or switch the tones off (see “Settings – Volume”).

Drinks menu

When **Select drink** appears in the display, you are in the drinks menu:

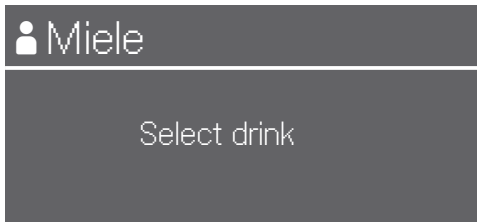

You can find more drinks in the **Other drinks** (☰ sensor) menu.

Selecting a menu and navigating within a menu

To select a menu, touch the ☰ sensor control.



You will then be able to start an action or change settings in the menu. A bar on the right-hand side indicates that further options or text are available.

To select an option, touch the ^ or v arrow sensor until the option you want is highlighted.

Touch *OK* to confirm your selection.

The setting in a list which is currently selected will have a tick ✓ beside it.

Exiting a menu or cancelling an action

Touch the ↶ sensor to exit the current menu.

Before using for the first time

Before using for the first time

- Remove any protective foil and stickers from the machine. Exception: Please do not remove any labels (e.g. the data plate) which are visible when you pull out the lower panel.

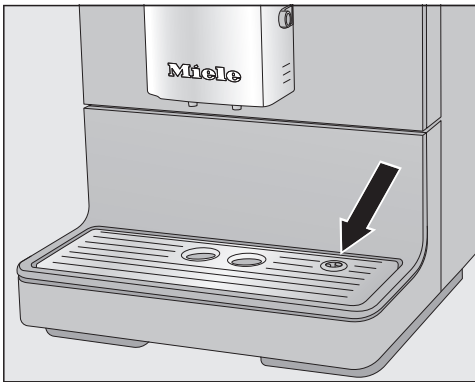

- Remove the protective foil from the drip tray cover and place the drip tray cover into the lower panel.
- Place the coffee machine on a level, flat surface that is not sensitive to water (see "Installation").

Clean the appliance thoroughly before filling it with water and coffee beans (see "Cleaning and care").

- Insert the plug of the coffee machine into the socket (see "Electrical connection").
- Remove the water container and fill it with fresh, cold tap water. Only fill the water container up to the "max." marker and then refit it in the machine (see "Filling the water container").
- Take the lid off the coffee bean container, fill it with roasted coffee beans and replace the lid (see "Filling the coffee bean container").

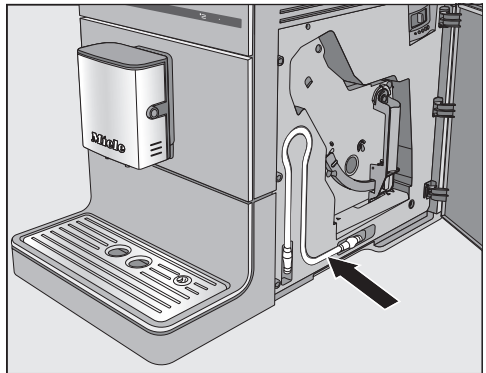

Useful tip: The milk tube can be stored behind the appliance door when not in use.

Switching on for the first time

- Touch the On/Off  sensor.

"Miele - Willkommen" appears briefly in the display.

- Use the \wedge / \vee arrow sensors to highlight the required language. Touch *OK*.
- Select the country if necessary and touch *OK*.

The setting is now saved.

The coffee machine is now successfully set up for use.

- Confirm with *OK*.

The coffee machine heats up and rinses the pipework. The water used for rinsing will run out of the central spout.

- Before making drinks with milk for the first time, rinse the milk pipework (see "Cleaning and care – Rinsing the milk pipework").

Before using for the first time

Please note that the full aroma of the coffee and typical crema will not develop fully until several coffees have been made.

To ensure that any coffee residues from the factory testing process are removed from the brewing system, please pour away the first two cups of coffee when using the coffee machine for the first time.

For the first coffee drinks, a larger quantity of coffee beans is ground. This means that powder from the coffee grounds may adhere to the lid of the drip tray.

Water hardness

Water hardness is an indication of the amount of minerals dissolved in water. The more minerals in the water, the higher the water hardness. The harder the water is, the more frequently the coffee machine needs to be descaled.

The coffee machine measures the amount of water used and steam made. Depending on the level of water hardness set, more or fewer drinks can be dispensed before the appliance needs to be descaled.

Set the water hardness level on the coffee machine to the water hardness level for the local area to ensure that the appliance functions correctly and is not damaged. A prompt to descale the machine will then appear in the display at the correct time.

Contact your local water supplier to find out your local water hardness range if necessary.

The machine is programmed ex-works to hardness level 3.

The appliance has 4 programmable hardness levels:

°dH	mmol/l	ppm (mg/l CaCO ₃)	Set- tings*
0–8.4	0–1.5	0–150	Soft 1
8.4–14	1.5–2.5	150– 250	Medium 2
14–21	2.5–3.8	250–375	Hard 3
> 21	> 3.8	> 375	Very hard 4

* The hardness level shown in the display may differ from the hardness level in your area. You **must** follow the values in the chart to set your machine to your local hardness level.

Setting the water hardness

- Touch the '☰ sensor.
- Select Settings  | Water hardness and confirm with OK.
- Select the hardness level and confirm with OK.

The setting is now saved.

Filling the water container

⚠ Risk to health due to contaminated water.

Bacteria can develop in water which has been sitting in the water container for too long and is a risk to your health.

Change the water in the water container **every day**.

Pour out the water from the water container if a drink has not been prepared for a long time.

- Fill the water container with fresh, cold tap water up to the “max.” mark.
- Replace the water container and close the lid.

Make sure that the water container handle is on the right so that the lid can close properly.

⚠ Risk of damage due to incorrect operation.

Unsuitable liquids such as hot or warm water or other liquids can damage the coffee machine.

Carbonated water leaves too much limescale in the coffee machine.

Only use cold, fresh tap water to fill the water container.

If the water container sits a little too high or at an angle, check that it is fitted correctly or whether the surface that it sits on is soiled. Water could leak. If necessary clean the surface that the water container sits on.



- Open the lid on the left-hand side of the coffee machine.
- Pull the water container upwards and out.

Filling the coffee bean container

Coffee or Espresso can be made from whole roasted coffee beans which are freshly ground for each portion. This requires the coffee bean container to be filled with coffee beans.

Alternatively, you can make coffee drinks with ready ground coffee (see "Making drinks with ready ground coffee").



Risk of damage to the grinder due to incorrect operation.

The coffee machine will be damaged if the bean container is filled with unsuitable substances such as liquids, ground coffee or coffee beans treated with sugar, caramel or similar.

In addition, green (unroasted) coffee beans or mixtures of coffee beans which contain green coffee beans can damage the grinder. Green coffee beans are very hard and still contain residual moisture. These can damage the coffee machine grinder as soon as grinding begins.

Only put roasted coffee beans in the bean container.

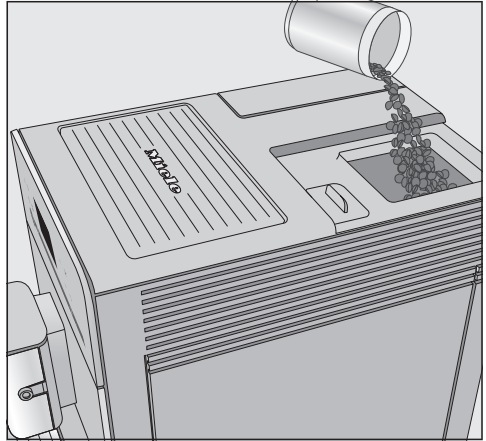

- Take the lid off the coffee bean container.
- Fill the container with roasted coffee beans.
- Refit the lid.

Useful tip: You can use a nut or seed grinder to grind green coffee beans. These types of grinder generally have a rotating stainless steel blade. You can then add the ground green coffee **one portion at a time** to the ground coffee chute and make the desired coffee drink.

Switching the coffee machine on

- Touch the On/Off  sensor.

The appliance will begin rinsing after the heating-up phase. Hot water will run out of the central spout.

When *Select drink* appears in the display, you can prepare drinks.

If the coffee machine is already at operating temperature, rinsing will not take place.

If you do not touch any sensors or run any maintenance programmes, the display will switch itself off after approx. 7 minutes to save energy.

The right-hand LED will flash on and off as long as the appliance is switched on.

- Touch any one of the sensors to wake the appliance up again to make a drink.

Switching the coffee machine off

- Touch the On/Off  sensor.

If the coffee machine has been used for making a drink it will rinse itself before switching off.

If you have made a drink using milk, Place milk pipe in drip tray will appear in the display.

- Insert the end of the milk pipe into the aperture in the drip tray, then touch *OK*.

Switching off for longer periods of time

If the coffee machine is not going to be used for a longer period of time, e.g. if you are going on holiday, please do the following:

- Empty the drip tray, the waste container and the water container.
- Clean all parts thoroughly, including the brew unit.
- Switch the machine off and, if necessary, withdraw the plug to disconnect it from the power supply.

Adjusting the central spout to the correct cup height

You can adjust the central spout to suit the height of the cup you are using so that the coffee or espresso will not cool down as quickly and the crema will have a better consistency.

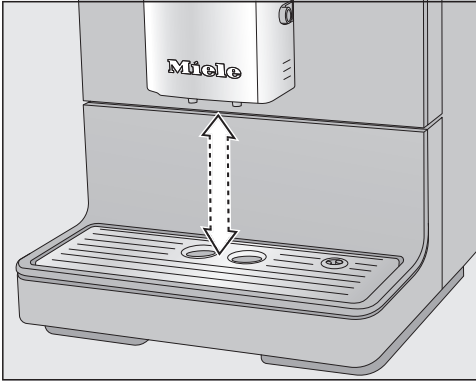

- Pull the central spout down until it is at the same level as the rim of the cup.
Alternatively, push the central spout up until there is enough room to fit a larger cup or mug underneath.

 Danger of burning and scalding on the dispensing spouts.

The liquids and steam dispensed are very hot and can cause scalding.

Keep well away from the area underneath the spouts when hot liquids and steam are being dispensed.

Do not touch hot components.

Making coffee drinks with and without milk

The following drinks can be made:

- **Ristretto** is a strong, concentrated espresso. It is prepared with the same amount of coffee as for an espresso but with much less water.
- **Espresso** is a strong aromatic coffee with a thick hazelnut brown coloured froth - known as the crema - on top. We recommend using espresso roasted coffee beans to make an espresso.
- **Coffee** differs from espresso by the increased amount of water and the roast of the beans. We recommend using coffee beans with the appropriate roast to make the coffee.
- **Long coffee** is a coffee with considerably more water.
- **Capuccino** consists of approx. 2/3 milk froth and 1/3 espresso.
- **Latte macchiato** consists of 1/3 each of hot milk, milk froth and espresso.
- **Caffè latte** consists of hot milk and espresso.

Hot milk or **milk froth** can also be made separately.

Preparing hot milk

Additives containing sugar or milk alternatives, e.g. soy milk, can clog the milk pipework and milk carrying parts. Residues from unsuitable liquids may adversely affect correct preparation.

Do not use milk with additives.

Use only pasteurised cow's milk.

If you have not made any milk drinks for a while, rinse the milk system thoroughly before making the first drink.

Useful tip: Using cold cow's milk (< 10 °C) with a protein content of at least 3% will produce the perfect milk froth.

You can select milk with a fat content according to preference. With full cream milk (at least 3.5% fat), the milk froth will be slightly creamier than with low-fat milk.

Making drinks

Using milk cartons or bottles

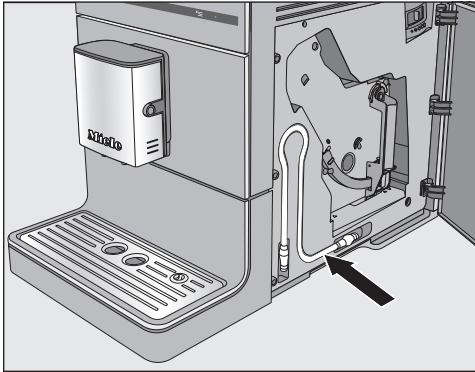

The milk tube for cartons and other suitable containers is located behind the appliance door.



- Connect the milk tube to the aperture in the central spout.
- Place a container with sufficient milk in it beside the coffee machine.
- Place the end of the milk tube in the container. Make sure that it is sufficiently immersed in the milk.

Useful tip: The Miele milk flask is the perfect addition to Miele coffee machines if you make a lot of coffees with milk. The milk flask is dishwasher-safe and easy to store in the fridge after preparing. Good milk froth can only be made with cold milk ($< 10\text{ }^{\circ}\text{C}$). The milk flask is available to order via the Miele webshop or directly from Miele (see the end of this booklet for contact details).

Making a coffee drink



- Place a cup or glass under the central spout.
- Select a drink: touch the sensor control for the drink you want. Alternatively, select a drink in the Other drinks menu (*≡ sensor).

Dispensing will start.

Cancelling preparation

- To cancel making a drink, touch the drinks sensor control or the *≡ sensor control for drinks from Other drinks again.

Preparation will be cancelled.

Useful tip: As soon as **Stop** appears in the display, you can cancel making a drink by touching the **OK** sensor control.

When making **coffee with milk** or **2 portions of a drink** you can cancel each stage individually by touching the **OK** sensor control.

2 portions (☐ sensor control)

You can also dispense two portions of a drink into one large cup or dispense two portions into two cups at the same time.



- To prepare two cups at the same time, place one cup under each of the coffee spouts.
- Touch the ☐ sensor immediately before or after you have started making a drink.

The dispensing starts and 2 portions of the desired drink will be dispensed.

If, after a while, you have not touched any of the drink sensor controls, the “2 portions” ☐ option will revert back to single portions.

Coffee pot

You can make several cups of coffee one after the other automatically with the **Coffee pot** function (max. 0.75 litre), e.g. to fill a coffee pot. Up to 6 cups can be made in this way.

You can use the **Coffee pot** function twice in a row. After this, the coffee machine needs to cool down for one hour in order to avoid it being damaged.

Make sure that the bean container and water container have enough beans and water inside them before starting the **Coffee pot** function.

- Place a sufficiently large container under the central spout.
- Touch the *☐ sensor.
- Select **Other drinks | Coffee pot** and confirm with **OK**.
- Select the number of cups you want (3 to 6) and confirm with **OK**.
- Follow the instructions in the display.

Each cup of coffee will be brewed and dispensed individually. The display will inform you about the progress.

Cancelling Coffee pot

- Touch the *☐ sensor.

Coffee pot dispensing will stop.

Making drinks with ready ground coffee

To make drinks using ready ground coffee, add a portion of ground coffee to the ground coffee chute.

This allows you to prepare a

Making drinks

decaffeinated coffee, for example, even if the bean container is filled with regular coffee beans.

Only **1** portion of coffee or espresso can be made at a time when using ready ground coffee.

Place a **maximum of 12 g** in the ground coffee chute.
If too much ground coffee is added, the brew unit will not be able to process the coffee.

- Replace the cover to the ground coffee chute after adding the ground coffee.
- Replace the lid on the coffee bean container.
- Place a cup or glass under the central spout.
- Select a drink.

The coffee machine will prepare the desired drink.

Adding ready ground coffee

The coffee machine will use all the ground coffee which has been added to the chute to make the next coffee.

- Touch the '≡ sensor.
- Select Other drinks | Ground coffee and confirm with *OK*.

Add ground coffee and select drink **appears** in the display.

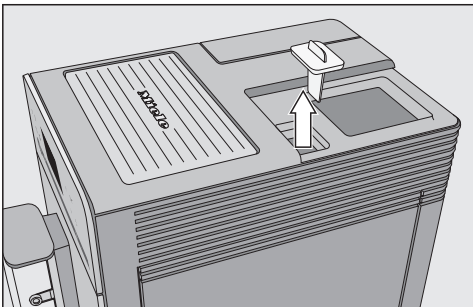

- First take the lid off of the coffee bean container and then take the cover off the ground coffee chute.

Place a **maximum of 12 g** in the ground coffee chute.

Dispensing hot water (CM 5410, CM 5510, CM 5710)

Please note that the water dispensed is not hot enough for making black tea.

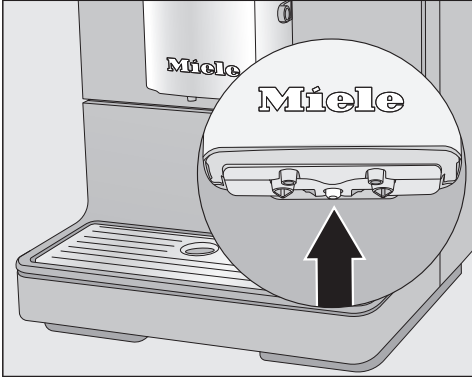

- Place a suitable cup or glass centrally underneath the central spout.
- Touch the '☰' sensor.
- Select Other drinks | Hot water and confirm with OK.

Hot water will run into the cup under the hot water spout.

Useful tip: To stop dispensing early, touch OK.

Grinder setting

When the beans are ground correctly, the coffee or espresso will flow evenly into the cup with a good crema. The crema should have an even hazelnut brown colour.

The grinder setting you select will be used for all coffee drinks.

There are various ways to tell whether the coffee grinder is set correctly.

The coffee has been **too coarsely** ground if:

- espresso or coffee flows into the cup too quickly,
- the crema is very pale and uneven.

Set a finer grinder setting.

The coffee has been **too finely** ground if:

- espresso or coffee flows into the cup very slowly,
- the crema is dark brown.

Set a coarser grinder setting.

Only adjust the grinder one setting at a time.

Start making a drink to grind beans again. Adjust the grinder setting one setting at a time again.

- Open the appliance door.

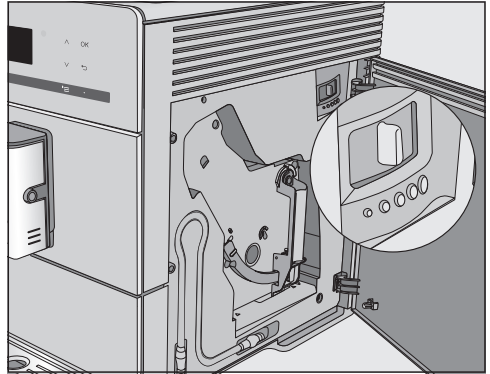

- Push the slide control a maximum of one setting to the left (for finer grinding) or to the right (for coarser grinding).
- Then close the appliance door.
- Make one cup of coffee.

Then you can adjust the grinder setting again.

The altered grinder setting will not be used until after the second coffee has been dispensed.

Amount of coffee, brew temperature and pre-brewing

You can set the amount of coffee, the brewing temperature and pre-brewing for each coffee drink individually. To do this, first select the drink from the Parameters menu and then adjust the drink parameters.

- Touch the '≡ sensor control and select Parameters.
- Select the drink and confirm with *OK*.

The current settings for the amount of coffee, brewing temperature and pre-brewing will be displayed for this drink.

- Select Amount of coffee, Brew temperature or Pre-brewing.
- Select the setting you want and confirm with *OK*.

The setting is now saved.

CM 5410, CM 5510, CM 5710: The changed parameter is always saved in the current profile. The name of the current profile is shown in the top left of the display.

Amount of coffee

The coffee machine can grind and brew 6–14 g of coffee beans per cup. The greater the quantity, the stronger the coffee.

There are various ways to tell whether the amount of coffee is set correctly:

The amount of coffee is **too low** if:

- espresso or coffee flows into the cup too quickly,
- the crema is very pale and uneven,
- the espresso or coffee lacks body.

Increase the amount of coffee so that more ground coffee is brewed.

The amount of coffee is **too high** if:

- espresso or coffee flows into the cup very slowly,
- the crema is dark brown,
- the espresso or coffee tastes bitter.

Decrease the amount of coffee so that less ground coffee is brewed.

Useful tip: If the coffee is too strong for you or it tastes bitter, try a different type of bean.

Brewing temperature

The ideal brewing temperature will depend on

- the type of coffee being used
- whether an espresso or a coffee is being made, and
- the altitude of the region.

Useful tip: Not all types of coffee tolerate high temperatures. Several types are sensitive to high temperatures, resulting in an impaired crema and taste.

Pre-brewing ground coffee

When you select pre-brewing, the coffee is moistened with a little hot water initially after it is ground. The remaining amount of water is then pressed through the moistened coffee grounds shortly after. This releases the aromas of the coffee better.

You can set a short or long duration for pre-brewing or turn the “Pre-brewing” function off completely.

Portion size

The flavour of the coffee produced depends not only on the type of coffee, but also on the amount of water used. You can programme the amount of water for all coffee drinks and hot water to suit the size of your cups and the type of coffee you are using. This does not alter the amount of coffee used.

For coffee drinks that use milk, you can not only set the amount of espresso or coffee, but also the amount of milk or milk froth to be dispensed with these drinks. Additionally, you can set the portion sizes for hot milk and milk froth alone.

A maximum portion size can be programmed for each type of drink. The coffee machine halts preparation of the coffee once this portion size has been reached. The maximum possible portion size is then saved by the appliance for this type of drink.

If the water container becomes empty during the preparation of a drink, the programming of the portion size will be cancelled. The portion size will **not** be saved.

There are two ways of initiating the programming of the portion size:

- by touching the drink sensor when you are preparing a coffee, or
- by selecting **Portion size** in the **Parameters** menu.

CM 5410, CM 5510, CM 5710: The changed portion size is always saved in the current profile. The name of the current profile is shown in the top left of the display.

labelling Cancellling portion size programming

- Touch the drinks sensor which is lit up or the '≡ sensor for drinks from Other drinks.

labelling Changing the portion size while making a drink

You can change and save the portion size for Espresso ☐, Coffee ☐, Cappuccino ☐ and Latte macchiato ☐ while making these drinks.

- Place a cup or glass under the central spout.
- Touch the sensor for the drink you want until **Change** appears in the display.

A signal tone will sound as soon as portion programming starts. (Provided that the volume has been set for the signal tones - see "Volume").

The desired drink will be made and **Save** will appear in the display.

- When the cup is filled up to the level you want, confirm with **OK**.

If you want to change the portion size for coffee specialities made with milk, the ingredients which make up the drink will be saved one after the other while the drink is being made.

- When the quantity for each ingredient reaches the level you want, confirm with **OK**.

The programmed combination of ingredients and portion sizes will now be dispensed every time that particular drink is selected.

Changing the portion sizes in the Parameters menu

You can only change the portion sizes for **Long coffee**, **Caffè Latte**, **Hot milk** and **Milk froth** via the Parameters menu.

- Place a suitable cup or glass underneath the central spout.
- Touch the '☰ sensor control and select Parameters.
- Select the drink you want.
- Select Portion size and confirm with *OK*.

Now proceed as for changing the portion size while making a drink.

User profiles

(CM 5410, CM 5510, CM 5710)

In addition to the Miele drinks menu (Miele profile), you can create individual profiles to cater for different tastes and preferences.

The portion quantities and parameters for all drinks can be adjusted in each profile.

The name of the current profile is shown in the top left of the display.

Creating profiles

- Touch the '≡ sensor control and select *User profiles*. Confirm with *OK*.

The *User profiles* menu opens.

- Select *Create profile*.

The editor will open in the display.

- Enter the profile name:
 - To enter a character, highlight a character and confirm the selection with *OK*.
 - To delete a character, touch the ↵ sensor.
 - A name is saved by selecting the tick ✓ and confirming with *OK*.

The profile is created.

Changing drinks in a profile

When you change the parameters within a profile, these settings only apply to the active profile. The settings for drinks in other profiles are not affected.

- Select the profile you want.

The name of the profile selected will be shown in the top left-hand corner of the display.

You can now change the drinks individually.

Preparing User profile drinks

- Place a suitable cup or glass underneath the central spout.
- Touch the '≡ sensor control and select *User profiles*.
- Select the profile you want and confirm with *OK*.
- Select the drink you want.

Drink preparation starts.

Changing a User profile name

This selection is only possible if a profile has been allocated in addition to the Miele standard profile.

- Select *Change name* with the arrow sensors ^ v and touch *OK*.
- Proceed the same as with “*Create profile*”:
 - Select ↵ to delete a character.
 - To enter new characters, select the relevant character and confirm with *OK*.
 - Save the new name by selecting ✓ in the display and touching *OK*.

Deleting a profile

This selection is only possible if a profile has been allocated in addition to the Miele standard profile.

- Select **Delete profile** and confirm with *OK*.
- Select the profile you wish to delete.
- Select **Yes** and confirm with *OK*.

The profile is deleted.

Setting when the profile should change (Change profile)

You can choose between the following options:

- **Manually:** The selected profile remains active until you select another profile.
 - **After each use:** The Miele profile is displayed after every drink.
 - **When switched on:** Every time the coffee machine is switched on, the Miele profile is displayed, regardless of which profile had been selected before switching off.
- Select **Change profile** and confirm with *OK*.
 - Select the option you want and confirm this with *OK*.

Settings

Displaying and changing Settings

The drinks menu is displayed.

- Touch the '☰' sensor.
- Select **Settings** and confirm with *OK*.
- Select the option you want to display or change.
- Confirm with *OK*.
- Change the setting as required and confirm with *OK*.

Language

You can select a language and country variant for all display texts.

Useful tip: If you select the wrong language by mistake, you can find the “Language” option again via the  symbol.

Timer: switch off after

If none of the sensors have been touched or no drink has been made, the coffee machine will switch itself off after 30 minutes to save energy.

You can change this default setting using the ∇/Δ arrow sensors to a time of between 15 minutes and 9 hours.

Eco mode

Eco mode is an energy-saving mode. The system heats up only once drink preparation has started.

Eco mode is activated by default.

Info (display information)

You can display the number of drink portions or the number of possible portions before maintenance programmes are necessary.

System lock

You can lock the coffee machine to prevent it being used without your knowledge, for example by children.

Overriding the system lock

- Touch *OK* for 6 seconds.

The system lock is activated the next time the machine is switched off.

Water hardness

Information regarding water hardness is given in the “Water hardness” section of this booklet.

Display brightness

Change the display brightness using the Δ/∇ arrow sensors.

Volume

You can set the volume of buzzer and keypad tones using the Δ/∇ arrow sensors.

Useful tip: To switch off the tones, touch the ∇ arrow sensor until all of the segments are empty and **Switched off** appears in the display.

Factory default settings

You can reset the settings back to the ones which were set when the coffee machine was delivered - the factory default settings.

The following will **not** be reset:

- The number of drinks dispensed and the appliance status (No. of portions until appliance needs descaling, ... brew unit needs degreasing)
- Language
- Profiles and the associated drinks (CM 5410, CM 5510, CM 5710)

Demo mode (showroom programme)

Do not activate this setting for domestic use.

The Showroom programme function enables the coffee machine to be demonstrated in stores or showrooms. Although the sensor controls and display seem to be working, the thermo block is not being heated. The appliance does not dispense any drinks, run the maintenance programmes or save any settings.

You can activate demo mode without commissioning the appliance for the first time. The water container is empty or not inserted. Switch the coffee machine on. As soon as the Fill and replace the water container message appears, touch the ↩ sensor for 5 seconds. Demo mode is active.

Cleaning and care



Risk to health due to inadequate cleaning.

Heat and moisture inside the coffee machine can cause coffee residues to become mouldy and/or milk residues to go off and pose a risk to health.

Carefully clean the coffee machine regularly.

Cleaning intervals - Quick guide

Recommended frequency	What do I have to clean / maintain?
Daily (at the end of the day)	Water container
	Waste container
	Drip tray and drip tray cover
Once a week (more often if heavily soiled)	Central spout with cappuccinatore
	Brew unit
	Area underneath the brew unit and the drip tray
	Housing of the machine (especially important immediately after descaling)
Once a month	Milk pipework
	Bean container and ground coffee chute
When prompted	Water container filter
	Degrease the brew unit (with 1 cleaning tablet)
	Descal the machine (with 1 descaling tablet)

Cleaning by hand or in the dishwasher

The brew unit is **not** dishwasher-safe.

Clean the brew unit by hand only under warm running water. **Do not use washing-up liquid or any other cleaning agent.**

The following must be cleaned **by hand only**:

- Central spout stainless steel cover
- Brew unit
- Bean container lid
- Lower panel

 Risk of damage as a result of excessively high dishwasher temperatures.

Components may be rendered unusable (e.g. deformed) if washed in a dishwasher at a temperature of more than 55 °C.

For dishwasher-safe parts, the maximum temperature of the dishwashing programme selected must not exceed 55 °C.

Contact with natural dyes such as those found in carrots, tomatoes and ketchup may discolour the plastic parts in the dishwasher. This discolouration does not affect the stability of the parts.

The following components are **dishwasher safe**:

- Drip tray and lid
- Drip tray cover
- Waste container
- Water container
- Central spout (without stainless steel cover)
- Ground coffee chute cover

Cleaning and care

 Danger of burning and scalding on hot components or by hot liquids. Components can become very hot during operation. Touching hot components can cause burning. The liquids and steam dispensed are very hot and can cause scalding. Keep well away from the area underneath the spouts when hot liquids and steam are being dispensed. Always allow the coffee machine to cool down before cleaning it. Please be aware that water in the drip tray can also be very hot.

 Risk of damage due to moisture ingress. The steam from a steam cleaner could reach electrical components and cause a short circuit. Do not use a steam cleaner to clean the coffee machine.

It is important to clean the machine regularly, as the used coffee grounds will soon go mouldy. Milk residues can go off and can block the milk pipework.

Unsuitable cleaning agents

Contact with unsuitable cleaning agents can alter or discolour all surfaces. All surfaces of this appliance are susceptible to scratching. Scratches on glass surfaces could cause a breakage in certain circumstances.

Remove any residual cleaning agent immediately. To protect the machine and surrounding surfaces from damage, make sure you remove any spillages or splashes of descaling agent immediately.

To avoid damaging the surfaces of your appliance, do not use:

- cleaning agents containing soda, ammonia, acids or chlorides
- solvent-based cleaning agents
- cleaning agents containing descaling agents (unsuitable for cleaning the housing)
- stainless steel cleaning agents
- dishwasher cleaners (unsuitable for cleaning the housing)
- glass cleaning agents
- cleaning agents for ceramic cooktops
- oven cleaner
- abrasive cleaning agents, e.g. powder cleaners and cream cleaners
- hard, abrasive brushes or sponges, e.g. pot scourers, brushes or sponges which have been previously used with abrasive cleaning agents
- dirt erasers

- sharp metal scrapers
- steel wool or stainless steel wire scourers

Waste container, drip tray and drip tray cover

Clean the drip tray and waste container **every day** to avoid unpleasant smells and mildew.

The waste container is located in the drip tray. Water from rinsing also collects in the waste container.

A prompt will appear in the display when the drip tray and/or the waste container is full and needs to be emptied. Empty the drip tray **and** the waste container.

 **Danger of burning and scalding!**
If the rinsing process has just finished, wait a while before removing the drip tray from the machine. The water used for rinsing will continue to run out of the coffee spouts for a while.

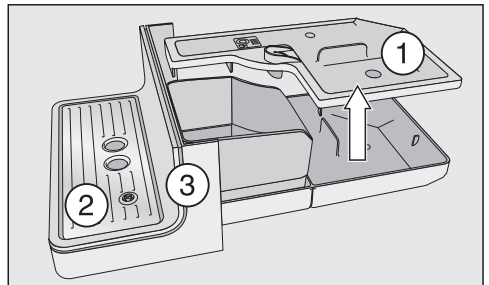

- Pull the drip tray carefully out of the machine. Take the lid ① off.
- Empty the drip tray **and** the waste container.
- Remove the drip tray cover ② and the lower panel ③.
- Clean all parts thoroughly.

Cleaning and care

Clean the lower panel by hand only using hot water, a little washing up liquid and a soft cloth. All other parts are dishwasher-safe.

- Clean the inside of the machine underneath the drip tray.
- Reassemble all parts and place the drip tray back in the coffee machine.

Make sure that the drip tray is pushed right into the coffee machine as far as it will go.

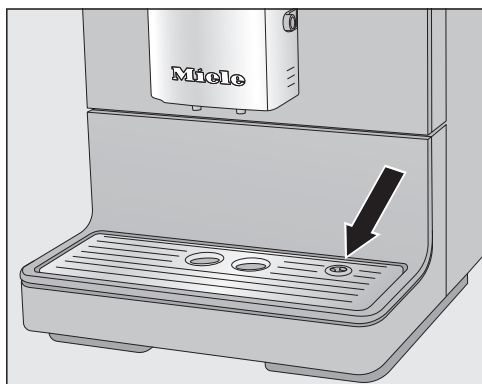

- Make sure that the drip tray cover is correctly fitted (see picture).
- Clean the area under the coffee machine. Water can get under the machine when the drip tray is removed.

Cleaning the water container

Clean the water container by hand every day. You can clean the water container in the dishwasher once a week.

Make sure that the valve, the underside of the water container and the surface the water container sits on are clean. Otherwise, the water container will not sit correctly.

- Remove the water container.
- Clean the water container in the dishwasher, or by hand using warm water and a little washing-up liquid applied with a soft cloth. After cleaning, dry the water container.
- Carefully clean and dry the surface the water container sits on, particularly the recesses.
- Push the water container back into the machine.

Removing and cleaning the water container filter

Clean the water container filter once a month.

The water container filter is located underneath the water container.

- Remove the water container.

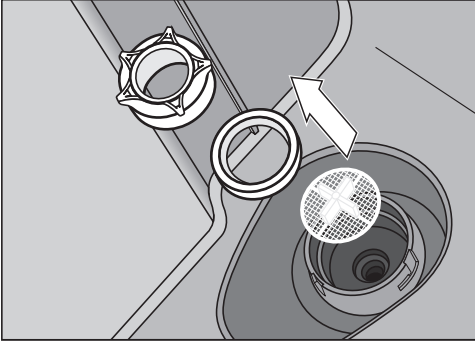

- Unscrew the cap. Remove the seal and the filter.
- Clean all parts thoroughly. Rinse all parts carefully under running water.
- Then replace the filter (with the cross facing upwards) and then the seal. The opening of the seal should face downwards. Finally screw the cap back on tightly.
- Push the water container back into the machine.

Central spout

Clean the central spout's stainless steel cover **by hand only**, using warm water and a little washing-up liquid.

All other parts are dishwasher-safe.

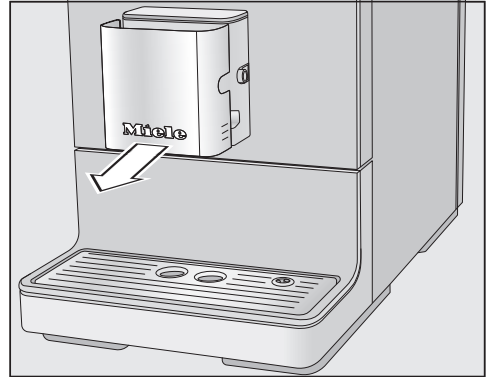

- Carefully pull the stainless steel cover off.

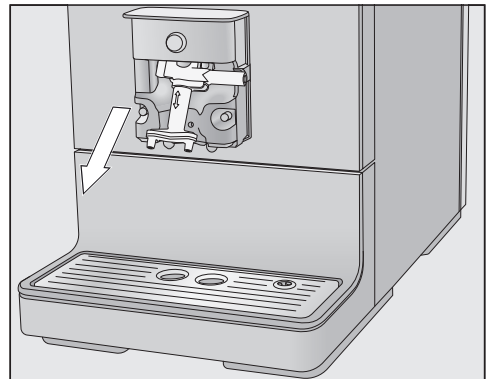

- Pull the dispensing unit down to remove it.

Cleaning and care

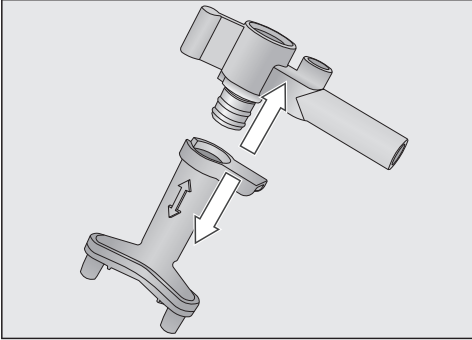

- Release the upper section with the holder for the milk pipework from the dispensing spouts.
- Clean all parts thoroughly.

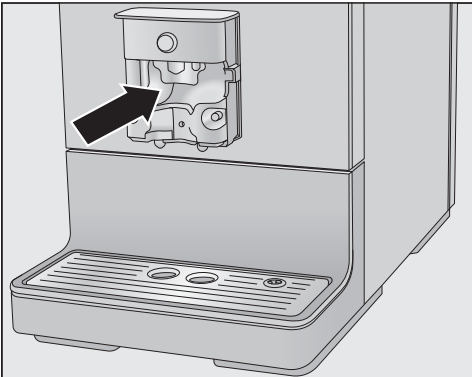

- Clean the surfaces of the central spout and the dispensing spouts with a damp cloth.

If the milk pipework connecting pieces are blocked, clean them under running water with the brush supplied:

- Insert the brush into the connecting piece. Move it back and forth until all milk residue has been removed.

Reassembling the central spout

The dispensing unit is easier to reassemble if the individual parts are dampened with water beforehand.

- Reassemble the dispensing unit.
- Refit the dispensing unit onto the central spout. Press firmly to ensure the dispensing unit is securely fitted without any gaps.
- Replace the stainless steel cover and connect the milk pipework if required.

Milk pipework

 Risk to health due to inadequate cleaning.

Milk naturally contains bacteria. Heat and moisture inside the coffee machine can cause these bacteria to multiply, e.g. milk residues can go off and pose a risk to health.

Clean all components in which milk is transported on a regular basis.

The milk pipework must be cleaned at least every 5 days.

There are two options for cleaning the milk pipework:

- You can remove and dismantle the central spout with its integrated cappuccinatore and either wash it in the dishwasher or by hand with warm water and a little washing-up liquid (see “Central spout with integrated cappuccinatore”).
- Or you can clean the milk pipework using the [Clean milk pipework maintenance programme](#) together with the Miele cleaning agent for milk pipework (see “Maintenance programmes - Rinsing the milk pipework”).

Useful tip: In addition to your weekly cleaning routine we recommend carrying out the alternative cleaning procedure once a month. For example if you manually clean the machine once a week, then you should run the [Clean milk pipework maintenance programme](#) once a month. This combination will ensure that the milk pipework is cleaned optimally.

Bean container and ground coffee chute

 Danger of injury on the grinder!
Switch off the machine and disconnect it from the power supply before cleaning the bean container.

Coffee beans contain oils which can deposit on the walls of the bean container and hinder the flow of the beans. Therefore, clean the bean container regularly with a soft cloth.

- Open the bean container.
- Remove any coffee beans.
- Clean the bean container with a dry, soft cloth.

The bean container can now be refilled.

If necessary, clean the ground coffee chute:

- Open the coffee chute and remove any ground coffee residue.

Useful tip: Use a vacuum cleaner to remove any coffee residues from the bean container and the ground coffee chute.

Cleaning and care

Cleaning the housing

If soiling is allowed to stay on for a long time or there is contact with unsuitable cleaning agents, surfaces can alter or discolour.

Remove any soiling immediately.

The surfaces of the coffee machine are susceptible to scratching.

Contact with unsuitable cleaning agents can alter or discolour the surfaces.

To protect the machine and surrounding surfaces from damage, make sure you wipe up any spillages or splashes of descaling agent immediately.

- Switch the coffee machine off.
- Clean the front with a soft sponge and a solution of warm water and a little washing-up liquid. Dry all parts with a soft cloth.

Useful tip: You can also clean the appliance front with the Miele all purpose microfibre cloth.

Opening the Maintenance menu

You can find the maintenance programmes in the Maintenance menu. Carry out the relevant maintenance programme when the prompt to do so appears in the display.

- Touch the '≡ sensor.
- Select Maintenance and confirm with **OK**.

You can now select a maintenance programme.

Rinsing the appliance

If coffee has been dispensed, the coffee machine will rinse the coffee pipework automatically before switching off. You can also start Rinse appliance manually.

Rinsing the milk pipework

Milk residues can block the milk pipework. The milk pipework should therefore be rinsed regularly. If a drink has been made using milk, the prompt to insert the end of the milk tube into the drip tray will appear at the latest when you switch the machine off.

You can also rinse the milk pipework manually.

- Touch the '≡ sensor.
- Select Maintenance | Rinse milk pipework and confirm with **OK**.

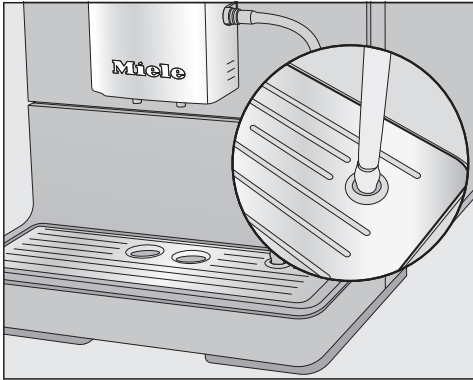

- When prompted, place the end of the milk tube into the right-hand aperture in the drip tray.
- Confirm with *OK*.

The milk pipework will now be rinsed.

Cleaning the milk pipework using the maintenance programme

For optimal cleaning results, we recommend the Miele Cleaning agent for milk pipework. The Cleaning agent for milk pipework has been specially developed for use with Miele coffee machines and prevents subsequent damage.

It is available to order from the Miele online shop or directly from Miele (see the end of this booklet for contact details).

To clean the milk pipework, 1 sachet of the Miele Cleaning agent for milk pipework is required.

The Clean milk pipework maintenance programme lasts for approx. 5 minutes.

- Touch the \equiv sensor.

- Select Maintenance | Clean milk pipework.

The cleaning process cannot be cancelled. It must be completed through to the end.

- Confirm with *OK*.

The process will start.

- Follow the instructions in the display.

Place milk pipe in cleaning agent appears in the display.

Making a cleaning solution:

- Dissolve the cleaning agent in a container with 200 ml of lukewarm water. Stir the solution with a spoon until the powder has fully dissolved.

Carrying out the cleaning process:



- Place the container next to the machine and hang the milk tube in the solution. Make sure it is placed sufficiently far into the cleaning solution.
- Confirm with *OK*.

Cleaning and care

- Follow the further instructions given in the display.

The cleaning process is finished at the end of the rinsing cycle.

Useful tip: Flush any residual cleaning agent out of the milk pipework with running water.

Degreasing the brew unit and cleaning the interior

Depending on the natural oil content of the coffee used, the brew unit can become blocked quite quickly. It must be degreased regularly in order to ensure aromatic coffee and trouble-free operation of the coffee machine.

We recommend using Miele Cleaning Tablets to clean the brew unit. These have been specially developed for use with Miele coffee machines and prevent subsequent damage.

Miele Cleaning Tablets can be ordered via the Miele webshop or directly from Miele (see the end of this booklet for contact details).

The maintenance programme for degreasing the brew unit lasts for approx. 15 minutes.

After 200 portions have been dispensed, a message prompting you to degrease the brew unit will appear in the display.

- Confirm the message with *OK*.

The message will appear at regular intervals. Once the maximum possible number of portions has been reached, the coffee machine will lock out. You can switch the coffee machine off if you do not want to carry out the maintenance programme at this point in time. You will only be able to make coffee drinks again once the the brew unit has been degreased.

Degreasing the brew unit

No drinks can be made and Degrease the brew unit and clean inside the machine appears in the display.

The cleaning process cannot be cancelled. It must be completed through to the end.

- Confirm with **OK**.

The maintenance programme will start.

- Follow the instructions in the display.

Cleaning the brew unit and the interior

Clean the brew unit **by hand** only under warm running water. **Do not use washing-up liquid or any other cleaning agent.** The moving parts of the brew unit are lubricated. Cleaning agents will damage the brew unit.

To ensure good tasting coffee and to prevent the formation of microbes in the machine, remove and clean the brew unit under running water once a week.

Rinse the brew unit by hand and clean inside the machine **appears in the display**.

- Open the appliance door.

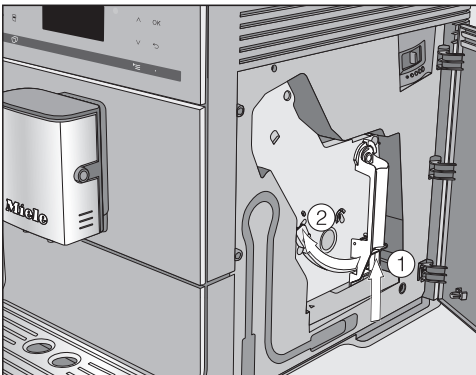

- Press and hold the button under the brew unit handle ① and, whilst doing so, turn the handle to the left ②.

- Carefully pull the brew unit out of the coffee machine.

When you have removed the brew unit, do **not** change the position of the handle on the brew unit.

- Clean the brew unit **by hand under warm running water** without using washing-up liquid or any other cleaning agent.

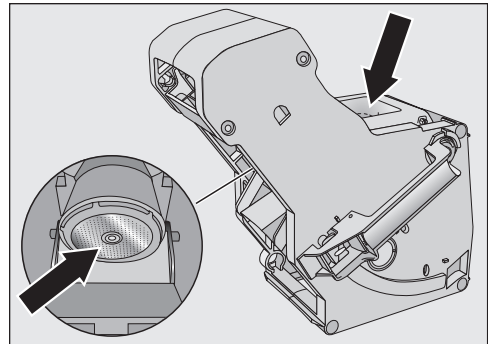

- Wipe any remaining coffee off the two filters (see arrows).
- Dry the funnel to prevent ground coffee sticking to it the next time a coffee is prepared.

⚠ Risk to health due to inadequate cleaning.

Damp coffee residues in the interior of the machine can go mouldy and pose a risk to health.

Remove coffee residues regularly and clean the interior of the machine.

Cleaning and care

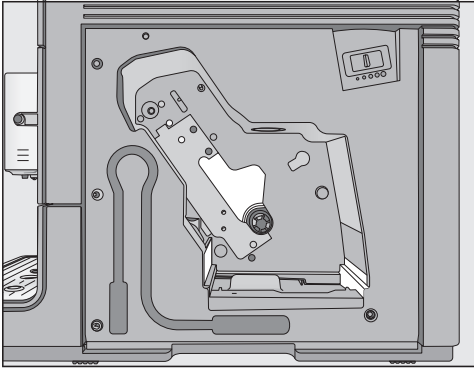

- Clean the interior of the coffee machine. Make sure that the areas highlighted (in white) in the illustration are cleaned especially well.

Useful tip: Use your vacuum cleaner to remove dry ground coffee residues.

Adding a cleaning tablet to the brew unit

Place the brew unit containing a cleaning tablet in the machine and close the machine door appears in the display.

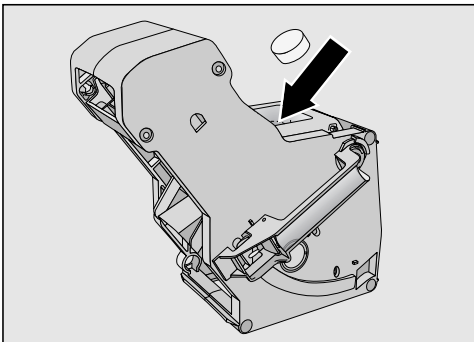

- Drop a cleaning tablet into the top of the brew unit (arrow).
- Push the brew unit with cleaning tablet back into the coffee machine, making sure it goes in straight.

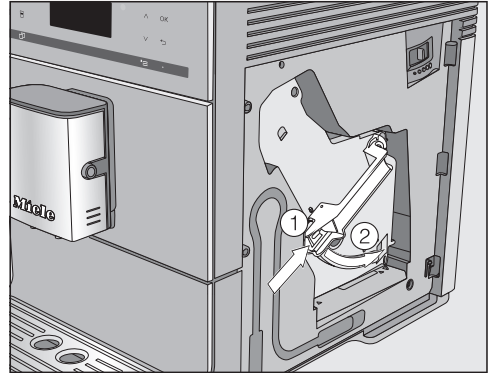

- Press the button under the handle of the brew unit ① and, whilst doing so, turn the handle to the right ②.
- Close the appliance door.
- Follow the further instructions given in the display.

The cleaning process is finished when the drinks menu appears in the display.

Descaling the appliance

Risk of damage from spilt descaling solution.

Sensitive surfaces and/or natural floors can suffer damage.

Wipe up any spillages of descaling agent immediately.

Limescale builds up in the coffee machine through use. How often the appliance needs to be descaled will depend on the water hardness level in your area. Limescale must be removed regularly.

The appliance will guide you through the descaling process. Various messages will appear in the display, e.g. you will be prompted to empty the drip tray or fill the water container.

The descaling process is **essential** and takes approx. 15 minutes.

The coffee machine prompts you when it needs to be descaled. No. of portions until appliance needs descaling: 50 will appear in the display. The remaining number of drinks that can be made before descaling will appear in the display after each drink.

■ Confirm the message with *OK*.

When the number of remaining portions reaches 0, the appliance will lock out.

You can switch the coffee machine off if you do not want to carry out the descaling programme at this point in time. You cannot make any drinks until the machine has been descaled.

Descaling after prompt appears in the display

Descale appliance appears in the display.

Descaling cannot be cancelled once it has started. It must be completed through to the end.

■ Confirm with *OK*.

The process will start.

■ Follow the instructions in the display.

When Fill the water container with descaling agent and lukewarm water up to the symbol  and replace **appears in the display**, proceed as follows.

Preparing the descaling solution

For optimum descaling results, we recommend using the Miele descaling tablets provided.

The descaling tablets have been specially developed for Miele coffee machines.

Other descaling agents, which contain other acids besides citric acid and/or other undesirable substances, such as chlorides, may cause damage to the product. Moreover, the descaling result required cannot be guaranteed if the descaling solution was not of the appropriate concentration.

Miele descaling tablets are available to order via the Miele webshop or directly from Miele (see the end of this booklet for contact details).

You will need **1** descaling tablet to descale the machine.

Cleaning and care

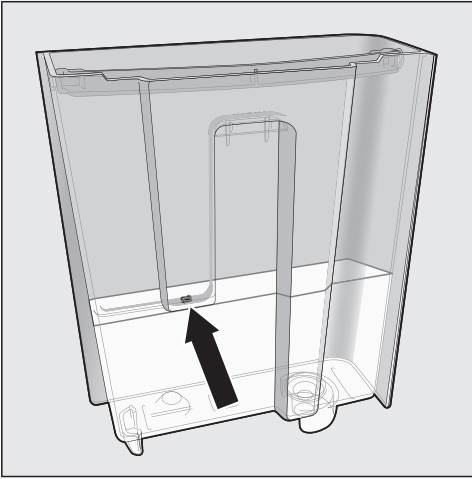

The descaling process has finished when the drinks menu appears in the display.

- Place 1 descaling tablet in the water container.
- Fill the water container to the marker S with lukewarm water.

Follow the instructions for the mixing ratio carefully. Fill the water container with the correct amount of water. Descaling will otherwise not be completed.

Carrying out descaling

- Push the water container back into the machine.
- Follow the further instructions given in the display.

When Rinse the water container and fill with fresh tap water up to the descaling symbol S appears in the display:

- Remove the water container and rinse it thoroughly with clean water. Ensure that **no** descaling solution residue remains in the water container. Fill the water container to the S symbol with fresh tap water.

Transporting the machine



If you are not going to use the coffee machine for an extended period of time and you intend to transport it, e.g. when moving house, a number of procedures will need to be carried out:

- Empty and clean the coffee bean container
- Empty and clean the water container
- Evaporate the coffee machine
- Clean the interior of the machine
- Pack the machine securely

Evaporating the coffee machine

The coffee machine should be evaporated before it is stored for a long period of time or transported any distance – particularly at temperatures below freezing.

Evaporating the appliance involves removing all traces of water from the system to prevent the risk of water and frost damage.

- Switch the coffee machine on with the On/Off  sensor.
- Touch the  sensor.
- Touch the  sensor control twice.

Empty the system? appears in the display.

- Select Yes and confirm with OK.
- Follow the instructions in the display.

 Danger of burning and scalding on the dispensing spouts.

Hot steam can cause scalding. Keep well away from the area underneath the spouts when hot liquids or steam are being dispensed.

Do not touch hot components.

The evaporation process is finished when Process finished appears in the display and the display then goes out.

- Switch off the machine and unplug it to disconnect it from the power supply.
- Clean the drip tray and waste container.

Packing

The coffee machine should only be packed when it is clean and dry. Residues of coffee grounds can cause scratches on surfaces. Coffee and milk residues or water can cause a build-up of bacteria.

Use the original packaging including polystyrene blocks to pack the coffee machine.

Also pack the operating instructions so that they are available when the coffee machine is next used.

Problem solving guide

With the help of the following guide, minor faults in the performance of the appliance, some of which may result from incorrect operation, can be remedied without contacting Miele. This will save you time and money because you won't need a service call.



Please note that a call-out charge will be applied to unnecessary service visits where the problem could have been rectified as described in these operating instructions.

Messages in the display



Error messages must be confirmed with **OK**. Otherwise the message may reappear in the display even though the problem has been remedied.

Follow the instructions which appear in the display to remedy the problem.

If the fault message appears again in the display, contact Miele.

Problem	Possible cause and remedy
F1, F2, F80, F82	There is an internal fault. <ul style="list-style-type: none">■ Switch the coffee machine off with the On/Off  sensor. Wait for approximately one hour before switching the appliance back on again.
F41, F42, F74, F77, F235, F236	There is an internal fault. <ul style="list-style-type: none">■ Switch the coffee machine off with the On/Off  sensor. Wait for approximately 2 minutes before switching the machine back on again.
F10, F17	No water or very little water is being drawn in. <ul style="list-style-type: none">■ Remove the water container. Fill the water container with fresh tap water and refit the water container.■ Remove and clean the water container filter (see “Cleaning and care – Removing and cleaning the water container filter”).

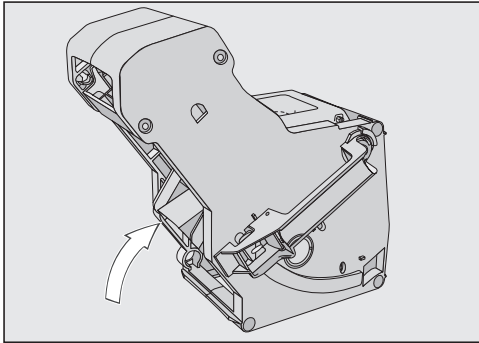

Problem solving guide

Problem	Possible cause and remedy
<p>F73 or Check the brew unit</p>	<p>The brew unit cannot be positioned correctly.</p> <ul style="list-style-type: none">■ Switch the coffee machine off with the On/Off  sensor.■ Switch off at the wall socket and remove the plug. Wait for two minutes before inserting the plug back in the socket and switching back on.■ Remove the brew unit and rinse under warm running water.  <ul style="list-style-type: none">■ Push the coffee ejector of the brew unit into the correct position (see diagram).■ Do not fit the brew unit. Close the appliance door and switch the coffee machine on with the On/Off  sensor. <p>This will initialise the brew unit motor and put it back into the start position.</p> <ul style="list-style-type: none">■ When Insert the brew unit appears in the display, open the appliance door and put the brew unit back in the machine. Close the appliance door.





Problem solving guide

Problem	Possible cause and remedy
Too much ground coffee	<p>There is too much ground coffee in the coffee chute. The brew unit cannot compact coffee powder if more than two level spoonfuls of ground coffee are added to the coffee chute. The ground coffee will be emptied into the waste container and the fault message will appear in the display.</p> <ul style="list-style-type: none">■ Switch the coffee machine off with the On/Off  sensor.■ Remove and clean the brew unit by hand (see "Cleaning and care - Degreasing the brew unit and cleaning the interior").■ Remove the ground coffee inside the coffee machine, e.g. with a vacuum cleaner.■ Place a maximum of 12 g of coffee in the ground coffee chute.

Unusual performance of the coffee machine

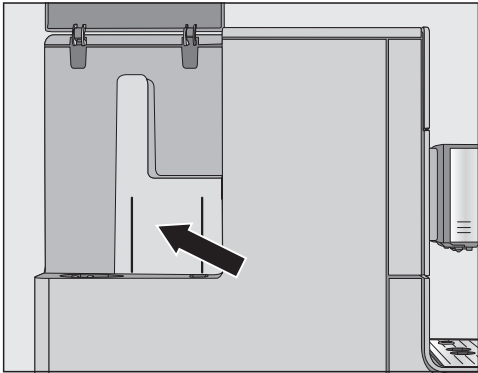
Problem	Possible cause and remedy
<p>The display remains dark when the coffee system is switched on with the On/Off  sensor.</p>	<p>The On/Off  sensor was not touched for long enough.</p> <ul style="list-style-type: none"> ■ Touch and hold the On/Off  sensor for at least 3 seconds.
	<p>The plug is not properly inserted into the socket or the socket is not switched on.</p> <ul style="list-style-type: none"> ■ Insert the plug into the socket correctly and switch on.
	<p>The mains fuse has tripped because the coffee machine, mains voltage or another appliance is defective.</p> <ul style="list-style-type: none"> ■ Switch off at the wall socket and remove the plug. ■ Contact a qualified electrician or Miele.
<p>The coffee machine switches off suddenly.</p>	<p>The switch-off time programmed using the timer has been reached.</p> <ul style="list-style-type: none"> ■ If required, you can select a new switch-off time (see “Settings - Timer”).
	<p>The plug is not correctly inserted into the socket or the socket is not switched on.</p> <ul style="list-style-type: none"> ■ Insert the plug into the socket correctly and switch on.
<p>The sensors do not respond to touch. The appliance cannot be operated.</p>	<p>There is an internal fault.</p> <ul style="list-style-type: none"> ■ Disconnect the appliance from the electricity supply by switching off at the wall socket and withdrawing the power plug, or switching off the mains circuit breaker.
<p>The display is hard to see or not able to be read.</p>	<p>The display brightness is set too low.</p> <ul style="list-style-type: none"> ■ Change this setting.

Problem solving guide

Problem	Possible cause and remedy
<p>The water container is empty. Fill and replace the water container has not appeared in the display.</p>	<p>Droplets of water have settled between the water container and the side walls of the housing, or this area is damp (see illustration).</p>  <ul style="list-style-type: none"> ■ Dry these surfaces thoroughly. Take the water container out to refill it with water. <p>There is too much residual water on the inside walls of the water container, e.g. a biofilm has developed. Alternatively, the water container has a build-up of limescale.</p> <ul style="list-style-type: none"> ■ Clean the water container every day.
<p>Fill and replace the water container appears in the display even though the water container is full and in the machine.</p>	<p>The water container is not in the correct position.</p> <ul style="list-style-type: none"> ■ Remove the water container and push it back in again. <p>The water container was not correctly filled and refitted for descaling.</p> <ul style="list-style-type: none"> ■ Fill the water container to the descaling symbol  and restart the descaling programme.
<p>Fill and replace the water container appears after switching on even though the container is filled and fitted in the machine. The appliance does not rinse.</p>	<p>The coffee machine needs descaling.</p> <ul style="list-style-type: none"> ■ Switch the coffee machine off with the On/Off  sensor. Wait approx. one hour. ■ Switch the appliance back on again. As soon as Heating-up phase appears, touch the  sensor control and then select Descale appliance. ■ Descal the coffee machine.

Problem solving guide

Problem	Possible cause and remedy
<p>After switching on the machine the message Empty the drip tray and the waste container appears even though they are both empty.</p>	<p>This is not a fault. When the drip tray and waste container are emptied after the coffee machine has been switched off, the internal counter is not reset. Empty the drip tray and the waste container appears in the display even though the drip tray and the waste container are not filled to the maximum. Remove the drip tray and waste container from the machine, empty them if necessary, and then refit them.</p>
<p>Neither milk nor milk froth comes out of the central spout.</p>	<p>The milk pipework is blocked.</p> <ul style="list-style-type: none"> ■ Clean the central spout, taking particular care to clean the cappuccinatore and milk pipework connections carefully with the cleaning brush.
<p>Empty the drip tray and the waste container appears in the display, even though the drip tray has been emptied.</p>	<p>The drip tray is not positioned correctly in the appliance.</p> <ul style="list-style-type: none"> ■ Push the drip tray in as far as it will go. ■ Make sure that the lower panel is sitting on the drip tray correctly. <p>When the drip tray and waste container are emptied after the coffee machine has been switched off, the internal counter is not reset. Empty the drip tray and the waste container appears in the display even though the drip tray and the waste container are not filled to the maximum.</p>
<p>Insert the drip tray and the waste container appears in the display even though both are fitted.</p>	<p>The drip tray is not in the correct position and is therefore not detected.</p> <ul style="list-style-type: none"> ■ Empty the drip tray and the waste container. Reassemble all parts and push the drip tray back as far as it will go in the coffee machine.
<p>The drip tray or waste container is full or overflowing, although they have been emptied following each reminder.</p>	<p>This is not a fault. The drip tray and waster container were probably removed or the appliance door was opened without the drip tray and waste container being emptied. When the drip tray is removed or the appliance door opened, the internal counter for emptying the drip tray and waste container is automatically reset.</p> <ul style="list-style-type: none"> ■ Remove the drip tray and waste container from the machine and empty them.

Problem solving guide

Problem	Possible cause and remedy
<p>Fill the bean container appears in the display even though the bean container has just been filled.</p>	<p>This is not a fault.</p> <ul style="list-style-type: none"> ■ Confirm the message with <i>OK</i>. <p>Insufficient coffee beans are getting into the grinder. Have you used a dark roast? This type of coffee bean is often oily. These oils can cling to the inside of the coffee bean container and hinder the flow of beans.</p> <ul style="list-style-type: none"> ■ Make a coffee and observe whether the coffee beans drop into the coffee bean container. ■ Clean the coffee bean container more often if you are using darker, oilier coffee beans. <p>Try other types of coffee beans which are less oily.</p>
<p>The coffee machine does not rinse itself when turned on.</p>	<p>This is not a fault.</p> <p>If the coffee machine is already at operating temperature, rinsing will not take place.</p>
<p>Coffee dispensing is repeatedly interrupted and the message Fill the bean container appears in the display.</p>	<p>This is not a fault.</p> <p>The brew unit has not detected the ground coffee. The coffee may be too finely ground or there may not be enough of it. Usually this is because the grinder is set too fine and the amount set is insufficient.</p> <ul style="list-style-type: none"> ■ Confirm the message with <i>OK</i>. <p>If the coffee is too strong for you or tastes bitter, try a different type of coffee beans.</p> <p>If the display appears with all types of coffee:</p> <ul style="list-style-type: none"> ■ Set the grinder to a coarser setting. ■ Check the amounts of coffee set for all coffee drinks. Select a larger amount of coffee if necessary. <p>Don't forget to check any drinks changed in "User Profiles".</p> <p>If the message only appears when dispensing certain drinks:</p> <ul style="list-style-type: none"> ■ Check the amount of coffee set for this drink. Select a larger amount of coffee. ■ You may also need to set a coarser grinder setting.

Problem solving guide

Problem	Possible cause and remedy
<p>The descaling programme was started by mistake.</p>	<p>The descaling programme cannot be stopped once the OK sensor has been touched. Descaling must be continued through to completion. This is a safety precaution to make sure the machine is descaled correctly. This is important for the longevity and functional efficiency of your coffee machine.</p> <ul style="list-style-type: none"> ■ Descalcify the coffee machine.
<p>The milk sputters when it is dispensed. Hissing noises can be heard when milk is being heated up or frothed. Although the milk should be frothed, only hot milk comes out of the main dispenser.</p>	<p>The milk temperature is too high. Good milk froth can only be achieved with cold milk (below 10°C).</p> <ul style="list-style-type: none"> ■ Check the temperature of the milk.
	<p>The main dispenser with integrated cappuccinatore is not correctly fitted and is taking in air. Or the spouts are blocked.</p> <ul style="list-style-type: none"> ■ Check whether the central spout has been assembled correctly. Make sure that all parts are tightly connected to one another. ■ If necessary, clean the central spout.
	<p>The milk pipework, connections or the intake tube on the milk flask are blocked.</p> <ul style="list-style-type: none"> ■ Clean all parts thoroughly.
	<p>The steam jet on the central spout has a blockage.</p> <div data-bbox="400 975 878 1318" data-label="Image"> </div> <div data-bbox="404 1326 1042 1414" data-label="Text" style="border: 1px solid gray; padding: 5px;"> <p>Push the cleaning brush a max. of 1 cm into the steam jet.</p> </div> <ul style="list-style-type: none"> ■ Clean the steam jet with the cleaning brush.

Problem solving guide

Problem	Possible cause and remedy
Coffee grounds have settled on the lid of the drip tray and in the interior around the brew unit.	This is not a fault. The movement of the brew unit during the brewing process can cause some ground coffee to fall around it. The type of beans used, the fineness of the ground coffee and the amount of coffee ground also affect the amount. Important: Clean the interior of the coffee machine regularly to prevent mould etc.
The underside of the coffee bean container cover is very damp. Drops of water are visible.	A large number of drinks have been made one after the other and the ground coffee chute is not closed or not properly closed. Steam has risen up from the brew unit via the ground coffee chute and condensed under the cover. ■ Replace the lid on the ground coffee chute making sure it is properly sealed.
Water from making coffee has collected on the benchtop underneath the coffee machine.	This is not a fault. Water can get under the machine when the drip tray is removed. Clean the surface underneath the coffee machine regularly.
The display lights up but the coffee machine does not heat up and no drinks are made. The coffee machine cannot be switched off.	The Demo mode of the coffee machine for Miele Experience Centres and Chartered Agents has been activated. ■ Deactivate Demo mode.

Unsatisfactory results

Problem	Possible cause and remedy
<p>The coffee is not hot enough.</p>	<p>The cup has not been pre-heated. The smaller the cup and the thicker its walls, the more important it is to pre-heat it.</p> <ul style="list-style-type: none"> ■ Pre-heat the cup, for example with hot water.
	<p>The brewing temperature has been set too low.</p> <ul style="list-style-type: none"> ■ Set a higher brewing temperature.
	<p>The filters in the brew unit are blocked.</p> <ul style="list-style-type: none"> ■ Remove the brew unit and clean it by hand. ■ Degrease the brew unit.
<p>The heating-up time is getting longer, the amount of water being dispensed is incorrect and the coffee machine is not performing properly. Coffee drinks are being dispensed very slowly from the central spout.</p>	<p>The coffee machine needs descaling.</p> <ul style="list-style-type: none"> ■ Descale the coffee machine.
<p>Coffee is not flowing out of the central spout. Or coffee is only being dispensed via one spout.</p>	<p>The central spout has a blockage.</p> <ul style="list-style-type: none"> ■ Rinse the coffee pipework. ■ If there is still no coffee coming out, or coffee is only coming out of one side, clean the dispensing spouts with the cleaning brush.
<p>The consistency of the milk froth is unsatisfactory.</p>	<p>The milk temperature is too high. Good milk froth can only be achieved with cold milk (below 10°C).</p> <ul style="list-style-type: none"> ■ Check the temperature of the milk in the milk flask.
	<p>The milk pipework is blocked.</p> <ul style="list-style-type: none"> ■ Clean the central spout with integrated cappuccinatore and the milk pipework with the cleaning brush supplied.

Problem solving guide

Problem	Possible cause and remedy
The coffee grinder makes a louder noise than usual.	The coffee bean container has become empty during the grinding process. ■ Fill the coffee bean container with fresh beans.
	There may be foreign objects such as plastic or stones in amongst the coffee beans. ■ Switch the coffee machine off immediately. Call Miele.
The coffee flows too quickly into the cup.	The coffee is too coarsely ground. ■ Set the grinder to a finer setting.
The coffee trickles too slowly into the cup.	The coffee is too finely ground. ■ Set the grinder to a coarser setting.
The crema on the coffee or espresso is not as it should be.	The grinder setting is not correct. ■ Set the grinder to a finer or coarser setting.
	The brewing temperature is too high for the type of coffee being used. ■ Set a lower brewing temperature.
	The coffee beans are no longer fresh. ■ Add fresh coffee beans to the coffee bean container.

Contact in case of fault

In the event of any faults which you cannot remedy yourself, please contact Miele.

You can book a Miele customer service call-out online at www.miele.com/service.

Contact information for Miele can be found at the end of this booklet.

Please quote the model and serial number of your appliance when contacting Miele. This information can be found on the data plate.

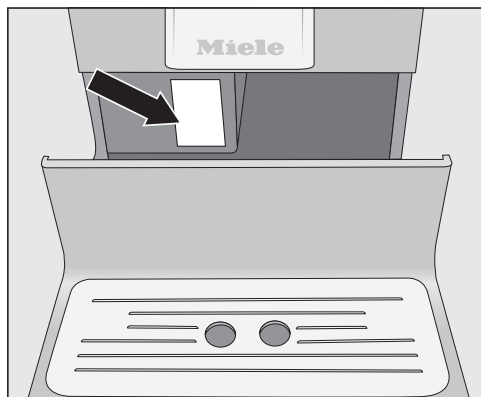

Warranty

The manufacturer's warranty for this appliance is 2 years.

For further information, please refer to your warranty booklet.

Saving energy

The following tips can help you save energy and money as well as care for the environment:

- Operate the coffee machine in "Eco mode" (default setting).
- Energy consumption may increase if you change the settings for the "Timer".

This setting uses more energy **appears in the display.**

- Switch the coffee machine off with the On/Off  sensor when it is not in use.
- Change the setting for the "Switch off after" timer to 15 minutes. The coffee machine will then switch itself off 15 minutes after the last drink was made or a sensor was touched.

Before connecting the appliance, make sure that the connection data on the data plate (voltage and frequency) match the mains electricity supply. This data must correspond in order to avoid the risk of damage to the appliance. If in any doubt, consult a qualified electrician.

The connection data is quoted on the data plate. The data plate can be seen on the left-hand side when the drip tray is pulled out.

The machine is supplied with a mains cable with moulded plug for connection to a 50 Hz 220-240 V supply.

The coffee machine must be connected to the mains supply via a suitable switched socket with earthing contact. Connection must comply with national and local safety regulations.

The fuse rating must be at least 10 A.

The socket should be next to the appliance and be easily accessible.

Do not connect the machine to the mains electricity supply by a multi-socket adapter or an extension lead. These do not guarantee the safety of the appliance (e.g. danger of overheating).

Do not connect the machine to an **inverter** such as those used with an autonomous energy source, e.g. solar power. When switched on, peak loads in the system can cause the safety switch-off mechanism to be triggered. This may damage the electronic unit.

The machine must not be used with so-called **energy saving plugs**. These reduce the amount of energy supplied to the machine, causing it to overheat.

If the mains connection cable is faulty, it must only be replaced by a qualified electrician in order to avoid a hazard.

Installation

 Danger of overheating due to insufficient ventilation.

If the coffee machine is not sufficiently ventilated, the appliance can overheat.

Ensure that there is sufficient ventilation around the coffee machine.

Do not cover the coffee machine with tea towels etc. while it is in use.

If the coffee machine is installed behind a closed furniture front, heat and moisture can build up behind the furniture front when closed. This can result in damage to the coffee machine and/or furniture unit.

Do not close the furniture front while the coffee machine is in use.

Please observe the following installation instructions:

- The location of the machine must be dry and well ventilated.
- The ambient temperature of the room in which the machine is used must be between +10 °C and +38 °C.
- The machine must be set up on a level, flat surface. The surface must be water resistant.

If the machine is installed in a niche, the niche must provide the following minimum dimensions:

Height	510 mm
Width	450 mm
Depth	575 mm

When setting up the machine: make sure that the appliance door of the machine can be fully opened so that the brew unit can be removed with ease when required.

- The machine must be set up in the niche such that it sits flush with the front edge of the niche.

Appliance dimensions

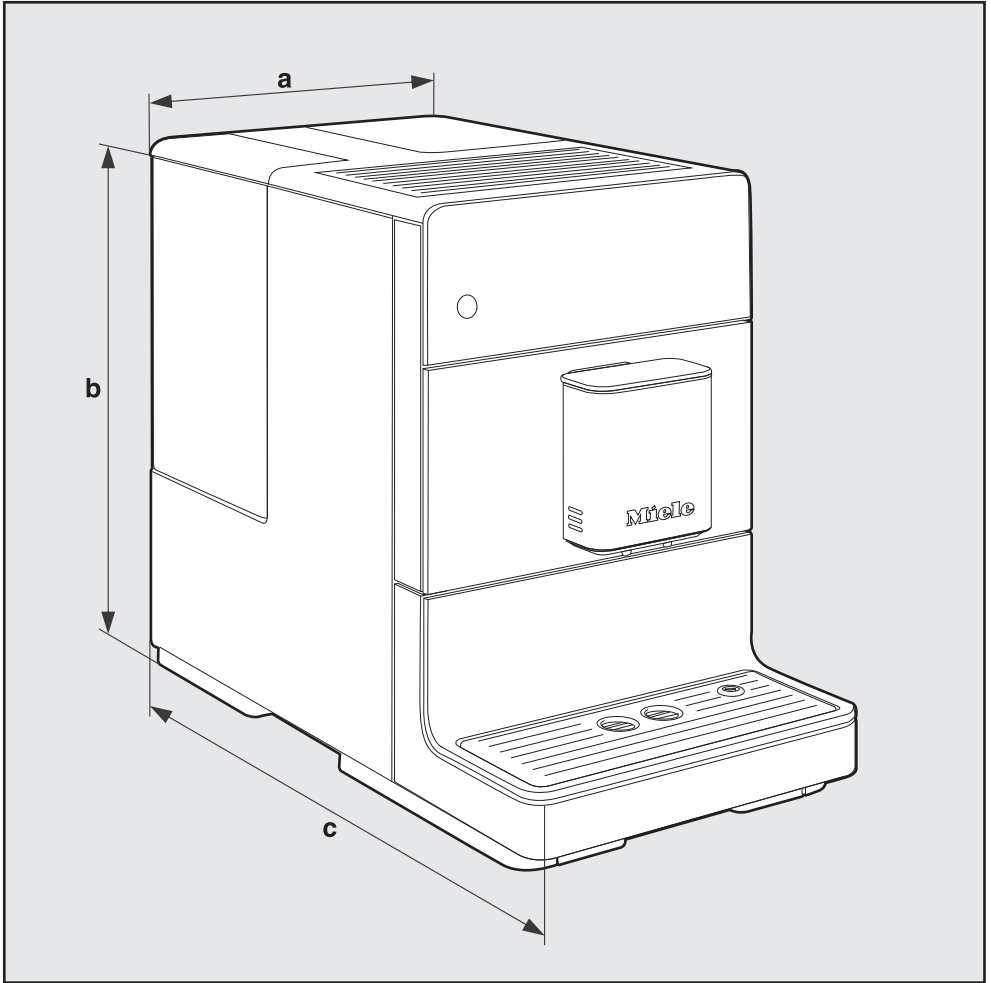

a = 241 mm

b = 360 mm

c = 460 mm

Technical data

Current draw in standby mode (default setting):	< 0.5 Watt
Pump pressure:	max. 15 bar
Through-flow heater:	1 stainless steel thermo block
Appliance dimensions (W x H x D):	241 x 360 x 460 mm
Net weight:	9.48 kg
Connection cable length:	120 cm
Water container capacity:	1.3 l
Bean container capacity:	200 g
Waste container capacity:	max. 6 portions of coffee grounds
Central spout:	Height-adjustable between 80–135 mm
Grinder:	Conical steel grinder
Grinder setting:	5 settings
Ground coffee amount:	max. 12 g



Miele Australia Pty. Ltd.

ACN 005 635 398
ABN 96 005 635 398

**Miele Experience Centre and
Head Office Melbourne:**

1 Gilbert Park Drive
Knoxfield, VIC 3180

Miele Experience Centre South Melbourne:

206-210 Coventry Street
South Melbourne, VIC 3205

Miele Experience Centre and Office Sydney:

3 Skyline Place
Frenchs Forest, NSW 2086

Miele Experience Centre and Office Brisbane:

Tenancy 4C, 63 Skyring Terrace
Newstead, QLD 4006

Miele Experience Centre Gold Coast:

131 Ferry Road
Southport, QLD 4215

Miele Experience Centre and Office Adelaide:

83-85 Sir Donald Bradman Drive
Hilton, SA 5033

Miele Experience Centre and Office Perth:

205-207 Stirling Highway
Claremont, WA 6010

1300 464 353 (1300 4 MIELE)

www.miele.com.au

Miele New Zealand Limited

IRD 98 463 631

Head Office:

Level 2, 10 College Hill
Freemans Bay, Auckland 1011

**Miele Experience Centre
Auckland:**

8 College Hill
Freemans Bay, Auckland 1011

**Miele Experience Centre
Wellington:**

183 Featherston Street
Wellington 6011

0800 464 353 (0800 4 MIELE)

www.miele.co.nz

Miele Global Headquarters

Germany

Miele & Cie. KG

Carl-Miele-Straße 29
33332 Gütersloh
Federal Republic of Germany

CM 5310, CM 5410, CM 5510, CM 5710

en – AU, NZ

M.-Nr. 11 557 710 / 00