



User's Manual

Chest Freezer

AERC05M3CWW

AERC05M3CBB

AERC07M3CWW

AERC07M3CBB

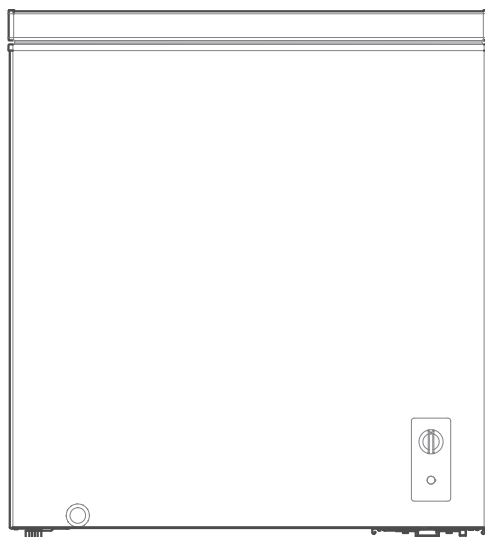

Please read the Manual carefully before use.
The Manual shall be kept in good custody for
later reference

CONTENTS

1 Safety warnings	
1.1 Warning	1
1.2 Meaning of safety warning symbols	3
1.3 Electricity-related matters	3
1.4 Matters related to use	4
1.5 Matters relating to the placement of items	5
1.6 Warnings for energy	5
1.7 Matters related to disposal	5
2 The correct usage of freezer	
2.1 Names of each component	6
2.2 Temperature control panel	7
2.3 Placement	7
2.4 Changing the light (optional)	8
2.5 Start	8
2.6 Energy saving tips	8
3 Maintenance and service of freezer	
3.1 Cleaning	9
3.2 Defrost	9
3.3 When out of use	9
4 Trouble shooting	10

1 Safety warnings

1.1 Warning



WARNING: risk of fire/flammable materials

THIS appliance is intended to be used in household and similar applications such as staff kitchen areas in shops, offices and other working environments; farm houses and by clients in hotels, motels and other residential type environments; bed and breakfast type environments; catering and similar non-retail applications.

THIS appliance is not intended for use by persons (including children) with reduced physical, sensory or mental capabilities, or lack of experience and knowledge, unless they have been given supervision or instruction concerning use of the appliance by a person responsible for their safety.

CHILDREN should be supervised to ensure that they do not play with the appliance.

IF the supply cord is damaged, it must be replaced by the manufacturer, its service agent or similarly qualified persons in order to avoid a hazard.

DO not store explosive substances such as aerosol cans with a flammable propellant in this appliance.

THE appliance has to be unplugged after use and before carrying out user maintenance on the appliance.

WARNING: Keep ventilation openings, in the appliance enclosure or in the built-in structure, clear of obstruction.

WARNING: Do not use mechanical devices or other means to accelerate the defrosting process, other than those recommended by the manufacturer.

WARNING: Do not damage the refrigerant circuit.

WARNING: Do not use electrical appliances inside the food storage compartments of the appliance, unless they are of the type recommended by the manufacturer.

WARNING: Please abandon the refrigerator according to local regulators for its use of flammable blowing gas and refrigerant.

WARNING: When positioning the appliance, ensure the supply cord is not trapped or damaged.

WARNING: Do not locate multiple portable socket-outlets or portable power supplies at the rear of the appliance.

DO not use extension cords or ungrounded (two prong) adapters.

WARNING: Risk of child entrapment. Before you throw away your old refrigerator or freezer:

-Take off the doors.

-Leave the shelves in place so that children may not easily climb inside.

THE refrigerator must be disconnected from the source of electrical supply before attempting the installation of accessory.

REFRIGERANT and cyclopentane foaming material used for the appliance are flammable. Therefore, when the appliance is scrapped, it shall be kept away from any fire source and be recovered by a special recovering company with corresponding qualification other than be disposed by combustion, so as to prevent damage to the environment or any other harm.

THE necessity that, for doors or lids fitted with locks and keys, the keys be kept out of the reach of children and not in the vicinity of the refrigerating appliance, in order to prevent children from being locked inside.

WARNING: To avoid a hazard due to instability of the appliance, it must be fixed in accordance

WARNING: Connect to potable water supply only. (Suitable for ice making machine)

TO Prevent A Child From Being Entrapped, Keep Out Of Reach Of Children And Not In The Vicinity Of Freezer (Or Refrigerator). (Suitable for products with locks)

1.2 Meaning of safety warning symbols



Prohibition symbol

This symbol indicates prohibited matters which the behaviors related to must be prohibited. Failure to follow instructions may result in damage to the product or endanger the user's personal safety.



Warning symbol

This symbol indicates matters that must be complied with and which the behaviors related to must be carried out in strict accordance with the required operation.

Failure to follow instructions may result in damage to the product or endanger the user's personal safety.



Note symbol

This symbol indicates matters requiring attention, which the behaviors related to require special attention. If left unguarded, this could result in minor or moderate injuries or product damage.

This Manual contains a lot of important safety information, please be sure to follow all of it.

1.3 Electricity-related matters

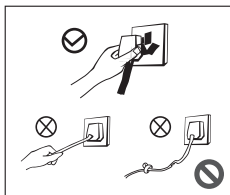

- Do not pull on the power line when unplugging the freezer. Be sure to hold the plug firmly and pull it straight out of the socket.
- For safe use, do not damage the power line at any time, and do not use the power line when it is broken or the plug is worn.
- If the power line is worn or damaged, it must be replaced at the manufacturer's designated service point.

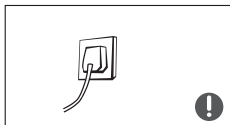

- The power line plug should be kept in firm contact with the socket, otherwise it may cause a fire. Please ensure that the grounding electrode of the socket should have a reliable ground wire.



- When flammable gases, such as coal gas, leak, you should first close the valve that causes the gas leak, and then open the doors and windows. At this time, do not pull out the plugs of electrical appliances, such as freezer, so as to avoid electric sparks causing a fire.

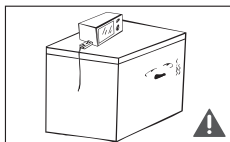

- For safety, it is recommended that electrical sockets, voltage stabilizers, rice cookers, microwave ovens, and other appliances are not placed on top of the freezer; and that appliances are not used in the food storage room of the appliance, except for the type recommended for use by the manufacturer.

1.4 Matters related to use

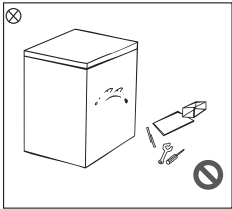

- It is strictly prohibited to privately disassemble and remodel the freezer, and to damage the refrigeration pipeline, and the maintenance of the freezer must be carried out by professional personnel.
- To avoid danger, if the supply cord is damaged, it must be replaced by the manufacturer, its maintenance department, and relevant professionals.

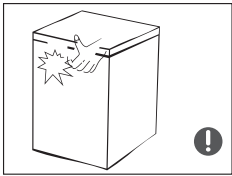

- There are small gaps between the doors and between the door and the freezer case, so be careful not to put your hand in these areas to prevent squeezing your fingers. When opening and closing the freezer door, do not use excessive force to prevent items from falling.
- After the freezer starts running, do not reach for food or containers in the freezer with wet hands, especially metal containers, to avoid frostbite on your hands.

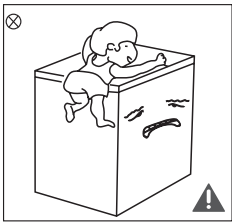

- Do not allow children to enter or climb on the freezer to avoid sealing children into the freezer or the freezer falling down, which may cause injury to children.
- Do not spray or rinse the freezer with water, and do not place the freezer in a damp, easily splashed place, and do not fill or load the freezer with water to avoid affecting the electrical insulation of the freezer, which may even lead to electric shock, fire and other accidents.

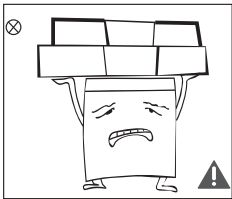

Please do not place heavy objects on the top of the freezer, as it is easy to cause the objects to fall down when closing the door, resulting in accidental damage.

1.5 Matters relating to the placement of items

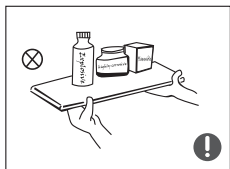

- Please do not place flammable, explosive, volatile and highly corrosive items into the freezer, so as not to cause product damage or fire and other accidents.
- Do not place or use combustible items near the freezer to avoid a fire.

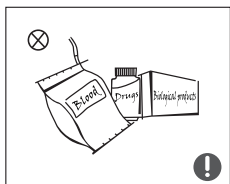

- This product is a household refrigeration appliance, and according to national standards, it is only suitable for storing food, and cannot be used for other purposes, such as storing blood, medicines and biological products.

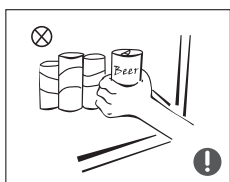



- Please do not put bottled or closed containers of fluid items such as bottled beer, drinks, etc. into the freezer to avoid freezing and cracking, which may cause other losses.

1.6 Warnings for energy

- Freezer might not operate consistently when sited for an extended period of time below the cold end of the range of temperatures for which the freezer appliance is designed.
- The fact that effervescent drinks should not be stored in food freezer compartments or cabinets or in low-temperature compartments or cabinets, and that some products such as water ices should not be consumed too cold;
- The need to not exceed the storage time recommended by the food manufacturers for any kind of food and particularly for commercially quick-frozen food in food-freezer and frozen-food storage compartments or cabinets;
- The precautions necessary to prevent an undue rise in the temperature of the frozen food while defrosting the refrigerating appliance, such as wrapping the frozen food in several layers of newspaper.
- The fact that a rise in temperature of the frozen food during manual defrosting, maintenance or cleaning could shorten the storage life.
- The necessity that, for doors or lids fitted with locks and keys, the keys be kept out of the reach of children and not in the vicinity of the freezer appliance, in order to prevent children from being locked inside.

1.7 Matters related to disposal

 The refrigerant and cyclopentane foaming material used in this freezer are flammable materials, and the used freezer should be isolated from sources of ignition and cannot be burned for disposal. Please hand over to qualified professional recycling company for disposal to avoid harming the environment or causing other dangers.

 When the freezer is abandoned and not in use, please remove the door of the freezer, and remove the door seal and shelf basket, and place the door and shelf basket in a suitable position, so as to avoid children from entering and playing, which may cause accidents.



Properly dispose of the product:

This symbol means that throughout the European Union, this product is not suitable to be disposed of with other household waste. To avoid causing potential danger to environment or human health because of uncontrolled waste treatment, recycle the waste to promote the sustainable reuse of material. In order to recycle the used devices, please use the recycle system or collecting system, or contact the product retailers. They can guarantee that the recycling process is environmental friendly and safe.

2 The correct usage of freezer

2.1 Names of each component

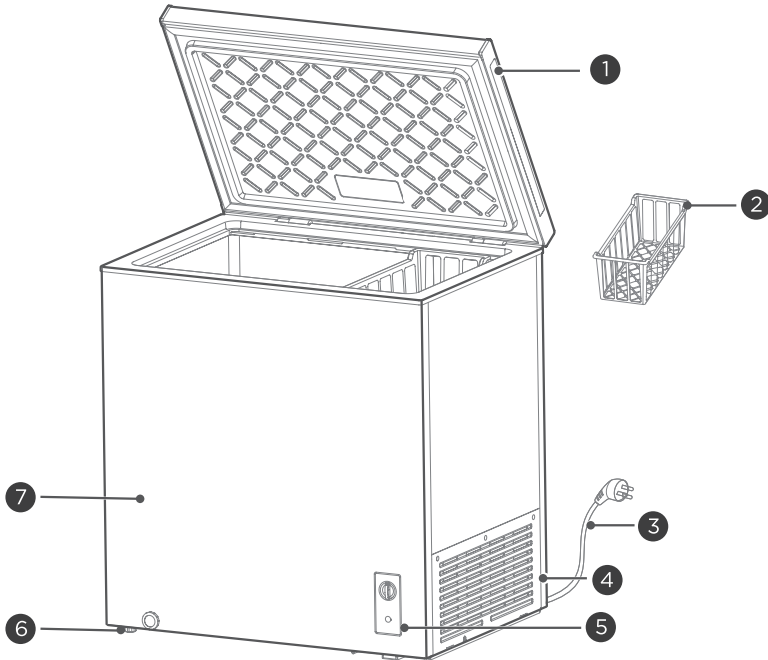

1	Door handle	5	Temperature control panel
2	Shelving basket	6	Leveling foot
3	Power cord	7	Cabinet
4	Shutter		

(The above pictures are for reference only, and the actual configuration shall be subject to the actual purchase or the seller's statement)

- The freezer can maintain the freshness of food for a long time at low temperatures. It is mainly used for storing frozen food and making ice cubes.
- The freezer is suitable for storing meat, fish, shrimp, and pastries that are not to be consumed in the short term. It is not suitable for storing fluids in bottled or sealed containers, such as bottled beer or beverages.
- Please note that the food should be consumed by its expiration date.
- The freezing speed of the product depends on the amount of food stored and the ambient temperature. If too much food at room temperature is placed at once, it is recommended to set the temperature controller to the maximum level and operate it for 24 hours in advance or use ice cubes for cooling. Moreover, large pieces of food should be divided into small pieces and stored separately to ensure proper freezing. Otherwise, certain parts of large or excessive food may not freeze properly, leading to potential spoilage.

Reminder:

Due to the wear and tear of the hinge during long-term opening and closing, the hinge's service life could be affected and noise may occur. It is recommended that users regularly apply lubricating oil to the hinges for maintenance, which can effectively eliminate noise and extend the service life of the hinges.

2.2 Temperature control panel

control panel without indicator light :

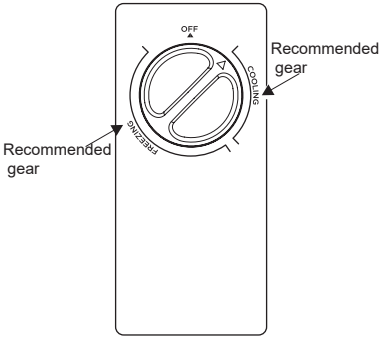

- The area where the temperature controller knob points to "COOLING" is the refrigeration area, and "FREEZING" is the frozen area;
- When the temperature controller knob is turned clockwise, the temperature inside the freezer decreases;
- When the temperature controller knob is turned counterclockwise, the temperature inside the freezer increases;
- At the OFF position: turn off the freezer;
- Please refer to the schematic diagram to identify the "recommended gear".

control panel with indicator light (optional):

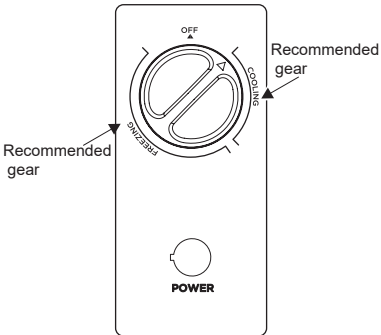

- After power on the "POWER" indicator light will be light(green).
- The area where the temperature controller knob points to "COOLING" is the refrigeration area, and "FREEZING" is the frozen area;
- When the temperature controller knob is turned clockwise, the temperature inside the freezer decreases;
- When the temperature controller knob is turned counterclockwise, the temperature inside the freezer increases;
- At the OFF position: turn off the freezer;
- Please refer to the schematic diagram to identify the "recommended gear".

(The above pictures are for reference only, and the actual configuration shall be subject to the actual purchase or the seller's statement)

2.3 Placement

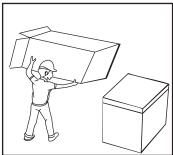

- Before using the freezer, please remove all the package, which includes the base pad, the foam cushion block in the freezer and adhesive tape, etc. And tear off the protective film on the door body and case.

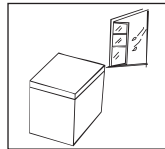

- Place the freezer in a well-ventilated indoor area with a flat and sturdy ground.

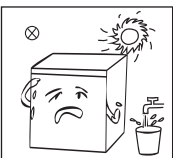

- Select the place that is far away from the heat source and direct sunlight Do not place it in damp or watery areas to prevent rusting or weakening the insulation effect.

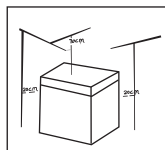

- The top space of the freezer should be greater than 70cm and the distance between the sides and back of the freezer and the wall should be greater than 20cm, so as to facilitate the opening and closing of the freezer door and heat dissipation.

2.4 Changing the light (optional)

The LED light must be replaced by a professional from the manufacturer, its maintenance department or other similar departments.

(The above are for reference only, and the actual configuration shall be subject to the actual purchase or the seller's statement)

2.5 Start

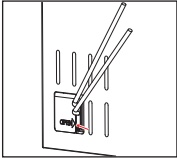

- Taking a tool (flat screwdriver or cone), insert it into the gap at the arrow position in the figure and gently pry it outward to open the flip.

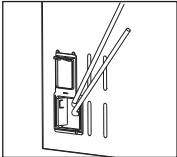

- After opening, the freezer is as shown in the figure. Next, take out the power line from the hole;

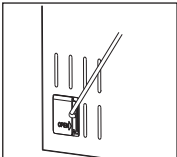

- After removing the power line, cover the cover plate again.

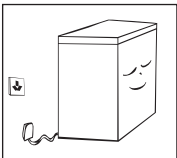

- After transportation, please let the freezer stand for at least 2 hours before connecting to the power supply, otherwise it may cause performance degradation or damage to the freezer. Before storing fresh or frozen food in the freezer, run the freezer for 2 to 3 hours; in hot summer days, users should run the freezer for 4 hours in advance. During the power cut or cleaning, users should pull the plug off and plug in again after a 5-minute interval in case the continuous start damage the compressor.

(The above are for reference only, and the actual configuration shall be subject to the actual purchase or the seller's statement)

2.6 Energy saving tips

- The appliance should be located in the coolest area of the room, away from heat producing appliances or heating ducts, and out of the direct sunlight. Let hot foods cool to room temperature before placing in the appliance. Overloading the appliance forces the compressor to run longer. Foods that freeze too slowly may lose quality, or spoil. Be sure to wrap foods properly, and wipe containers dry before placing them in the appliance. This cuts down on frost build-up inside the appliance. Appliance storage bin should not be lined with aluminum foil, wax paper, or paper toweling. Liners interfere with cold air circulation, making the appliance less efficient. Organize and label food to reduce door openings and extended searches. Remove as many items as needed at one time, and close the door as soon as possible.

3 Maintenance and service of freezer

3.1 Cleaning

- Please clean the dust behind and around the freezer on time to improve heat dissipation and save energy.
- Regularly inspect the door seal to ensure it is clean and free of debris. Clean the door seal with a soft cloth dipped in soapy water or diluted cleaning agent.
- The interior of the freezer should be regularly cleaned to avoid odor.
- Before cleaning the interior of the freezer, please turn the power off, take out all the food, hanging baskets and containers.
- Please use a soft cloth or sponge to clean the inner liner of the freezer. You can use two tablespoons of baking soda and one quart of warm water solution to clean it first, then clean it with clean water and wipe it clean. After cleaning, open the door and let it dry naturally before connecting to the power supply.
- For areas inside the freezer that are not easy to clean (e.g. gaps or corners), it is recommended to use soft cloths, soft brushes, etc. and some necessary aids (e.g. thin sticks, etc.) to carry out regular cleaning to ensure that there are no accumulation of pollutants or bacteria.
- Do not use soaps, detergents, spray cleaners, etc. to clean the liner as these may create odors or contamination.
- Clean the hanging basket with a soft cloth dipped in soapy water or diluted cleaning agent, and then dry it with a soft cloth or air dry naturally.
- Wipe the outside surface of the freezer with a soft cloth moistened with soapy water, detergent, etc., and then dry with a soft cloth.
- Do not use hard hairbrush, steel wire ball, steel wire brush, abrasive (such as toothpaste), organic solvent (such as alcohol, acetone, isoamyl acetate, etc.), boiling water, or acidic or alkaline substances during cleaning, as it may damage the surface and inner liner of the freezer. Organic solvents such as boiling water and benzene may deform or damage plastic parts.
- Do not rinse directly with water or other liquids during cleaning to avoid short circuit or affecting electrical insulation performance after soaking.



! When defrosting and cleaning the freezer, unplug the power supply first.

3.2 Defrost

- Freezers need to be manually defrosted:
When defrosting, please unplug the power plug first, open the freezer door, and take out indoor food, hanging baskets, etc.; Open the drain hole and outlet hole (and place a water container at the outlet hole) to allow the indoor ice and frost to naturally melt, and dry the defrosting water with a dry soft cloth. Once the frost softens, you can use an ice shovel to speed up deicing.
- When defrosting, please keep the removed food in a cool place before removing the accessories.

! Do not use mechanical devices or other means of acceleration other than those recommended by the manufacturer. The refrigeration circuit must not be damaged.

3.3 When out of use

- In case of power failure: Even in the summer, food can still be stored for several hours; During this period, the number of opening door should be reduced, and fresh food should not be put in.
- When not in use for a long period of time: unplug the power supply, then clean the freezer and keep the freezer door open to prevent the freezer from generating odors.
- When moving the freezer: Do not invert, transport horizontally, or vibrate the freezer during transportation. The inclination angle during transportation should not exceed 45°. Do not grab the door or hinge while moving.

! Once the freezer is activated, it is best to use it continuously, and under normal circumstances, do not stop using the freezer, so as not to affect the service life.

4 Trouble shooting

For some of the following simple problems, you can try to solve them by yourself. If there is no improvement, please call the after-sales service department.

The freezer does not work	<p>Whether the power supply is connected and the plug is firmly inserted</p> <p>Whether the voltage is too low</p> <p>Whether the temperature control knob is in the work area</p> <p>Is there a power outage or partial circuit tripping</p>
The freezer smells bad	<p>Odorous food should be tightly packed</p> <p>Check for rotten food</p> <p>The interior of the freezer needs to be cleaned</p>
Long term operation of the compressor	<p>It is normal for freezers to work for a long time due to high temperatures in summer</p> <p>Do not put too much food into the freezer at one time.</p> <p>Put the food into the freezer after it has cooled down</p> <p>Open the freezer door too often</p> <p>The frost layer of the freezer is too thick (defrosting is required at this time)</p>
The freezer light does not light up	<p>Whether the freezer is powered on and whether the indicator light is damaged</p>
The freezer door cannot be closed correctly	<p>The food package is jammed so the door cannot be closed</p> <p>Too much food has been put in</p> <p>Freezer tilts</p>
Loud noise	<p>Whether the ground is flat and the freezer is placed stably</p> <p>Whether the accessories of the freezer are placed in the normal position</p>
It is difficult to open the freezer for a short time	<p>After the refrigeration of the freezer, there is a pressure difference between the inside and outside of the case, which can cause a temporary difficulty in opening the door. This is a normal physical phenomenon.</p>
Case emits heat External condensation	<p>When the freezer is running, the outer shell of the case will generate heat, even generating more heat in the early stages of operation and summer. This is caused by the heat dissipation of the condenser and is a normal phenomenon.</p> <p>When the environmental humidity is high, there may be condensation on the surface of the case and the door seal, which is a normal phenomenon. Wipe dry with a dry towel.</p>
Airflow sound Buzzing sound Clattering sound	<p>The refrigerant circulating in the refrigeration pipeline will produce an eruption sound and a grunt sound, which is a normal sound and will not affect the cooling effect.</p> <p>The compressor produces a buzzing sound during operation, and the sound is loud when starting or stopping.</p> <p>The electromagnetic valve or electric switching valve will make a clattering sound, which is a normal phenomenon and will not affect its use.</p>