

Weceleleh

GAS COOKTOP

Instruction Manual

Please read this manual before the operation, and keep this manual for future use.

TO RECEIVE ANY SERVICE PLEASE CONTACT WITH:support@weceleleh.com;



Thank you for choosing our gas cooktop.

To use this appliance correctly and prevent any potential risk, **it is important to read this instruction carefully**. It provides information for a safe installation, use and maintenance. Keep this instruction in a safe place for future reference.

The manufacturer reserves the right to make all the modifications to its products that it deems necessary or useful, also in your interests, without prejudicing its essential functional and safety characteristics.

The manufacturer cannot be held responsible for any inaccuracies due to printing or transcription errors that may be found in this instruction.

N.B.: the pictures shown in the figures in this instruction are purely indicative.

- The installation, adjustments, conversions and maintenance jobs must only be carried out by authorized personnel.
- The installation of all-gas and combi appliances must comply with the standards in force.
- The appliance must only be used for what it has been made for, that is, cooking for home use. Any other use is considered improper and, as such, dangerous.
- The manufacturer cannot be held responsible for any harm to people or damage to things deriving from an incorrect installation or maintenance or from an erroneous use of the appliance.
- Once the outer wrapping and the inner wrappings of the various parts have been removed, check and make sure that the appliance is in perfect condition. If you have any doubts do not use the appliance and call in a qualified person.
- The packaging materials used (cardboard, bags, polystyrene foam, nails, etc.) must not be left anywhere in easy reach of children because they are a potential hazard source. To safeguard the environment all packaging materials are environment friendly and recyclable.
- The electrical safety of this appliance is only guaranteed if it is correctly connected to a good earth system, as prescribed by the electrical safety standards. The manufacturer declines all responsibility if these instructions are not followed. Should you have any doubts ask for an accurate control of the system by qualified personnel.
- Prior to connecting the appliance ensure that the rating plate data correspond to those of the gas and electricity mains.

If an appliance is out of order or is not going to be used any more, it must be rendered useless by eliminating those parts that could be a hazard source for children when they are playing, for example:

⇒ The power cables.

DO NOT SPRAY AEROSOLS NEAR THIS APPLIANCE WHILE IT IS IN OPERATION.

DO NOT STORE OR USE FLAMMABLE LIQUIDS OR ITEMS NEAR THIS APPLIANCE.

NOT FOR USE IN MARINE CRAFT, CARAVANS OR MOBILE HOMES UNLESS EACH BURNER IS FITTED WITH A FLAME SAFEGUARD.

WHERE THIS APPLIANCE IS INSTALLED IN MARINE CRAFT OR IN CARAVANS, IT SHALL NOT BE USED AS A SPACE HEATER

DO NOT MODIFY THIS APPLIANCE.

This appliance is not intended for use by persons (including children) with reduced physical, sensory or mental capabilities, or lack of experience and knowledge, unless they have been given supervision or instruction concerning use of the appliance by a person responsible for their safety.

Children should be supervised to ensure that they do not play with the appliance.

If the supply cord is damaged, it must be replaced by the manufacturer, its service agent or similarly qualified persons to avoid a hazard.

Contents

1. IMPORTANT SAFETY INSTRUCTIONS.....	04
2. DESCRIPTION OF THE GAS COOKTOP.....	07
3. DIMENSIONS AND CLEARANCE.....	08
4. INSTALLATION OPTIONS.....	09
5. USE GAS COOKTOP.....	11
6. KEEP GAS COOKTOP IN SHAPE.....	11
7. PRACTICAL ADVICE	13
8. TROUBLE SHOOTING.....	14
9. BURNERS AND NOZZLE SPECIFICATIONS	15
10. VALVE & FLAME ADJUSTMENT.....	16

IMPORTANT SAFETY INSTRUCTIONS

Please Read all instructions completely and carefully.

! CAUTION !

IMPORTANT: Save these instructions for local inspector's use.

IMPORTANT: Observe all governing codes and ordinances

Note to Installer: Be sure to leave these instructions with the Consumer

Note to Consumer: Keep these instructions for future reference.

IMPORTANT: Check the leakage according to the installation instruction.

Product failure due to improper installation is not covered under the Warranty

Disconnect all electrical power at the main circuit breaker or fuse box before installing. Installation of this cooktop must conform with local codes or, with the National Fuel Gas Code.

- Be sure your cooktop is installed properly by a qualified installer or service technician.
- To eliminate reaching over surface burners, cabinet storage above burner should be avoided
- Do not install the unit near an outside door or where a draft may affect its use.

! WARNING !

FOR YOUR SAFETY: If the information in this manual is not followed exactly, a fire, explosion or gas leak may result, causing property damage, personal injury or death.

Do not store or use gasoline or other flammable vapors and liquids in the vicinity of this or any other appliance.

! CAUTION !

WHAT TO DO IF YOU SMELL GAS

- Do not try to light any appliance. Do not touch any electrical switch; do not use any phone in your building.
- Immediately call your gas supplier from a neighbor's phone. Follow the gas supplier's instructions.
- If you cannot reach your gas supplier, call the fire department.
- Installation and service must be performed by a qualified installer, service agency or the gas supplier.

! WARNING !

- A statement that the installation must conform with local codes or, with the National Fuel Gas Code.

A statement that the installation of appliances designed for manufactured (mobile) home installation must conform with the Manufactured Home Construction and Safety Standard, or with local codes where applicable.

- If an external electrical source is utilized, a statement that the appliance, when installed, must be electrically grounded in accordance with local codes or, in the absence of local codes, with the National Electrical Code.

- A statement that:

The appliance and its individual shutoff valve must be disconnected from the gas supply piping system during any pressure testing of that system at test pressures in excess of 1/2 psi (3.5kpa).

The appliance must be isolated from the gas supply piping system by closing its individual manual shutoff valve during any pressure testing of the gas supply piping system at test pressures equal to or less than 1/2 psi (3.5kPa).

- A statement of the maximum gas supply pressure in accordance with the inlet pressure rating of the gas appliance pressure regulator supplied.

- A description of proper vent installation, if applicable, and the specific type of gas vent to be used, including a statement that the vent pipe must be mechanically fastened to the flue collar and instructions for accomplishing this attachment.

- The cooktop, as shipped from the factory, is set for use with its intended gas. If you wish to use your cooktop with the alternate gas, you must first replace the orifices and convert the pressure regulator.

- This conversion must be performed by a qualified installer or gas supplier in accordance with the manufacturer's instructions and all codes and requirements of the authority having jurisdiction. Failure to follow instructions could result in serious injury or property damage. The qualified agency performing this work assumes responsibility for the conversion.

•

ELECTRICAL REQUIREMENTS

This appliance must be supplied with the proper voltage and frequency and connected to an individual, properly grounded branch circuit, protected by a circuit breaker or fuse having amperage as noted on the rating plate.

We recommend you have the electrical wiring and hookup of your cooktop connected by a qualified electrician. After installation, have the electrician show you where your main cooktop disconnect is located.

Check with your local utilities for electrical codes which apply in your area. Failure to wire your cooktop according to governing codes could result in a hazardous condition. If there are no codes, your cooktop must be wired and fused to meet the requirements of the **National Electrical Code**.

Electrical supply:

This cooktop features pilotless electric ignition for energy savings and reliability. It operates on a 120-volt, 60 Hz power supply. A separate circuit, protected by a 15-amp time delay fuse or circuit breaker is required.

A properly-grounded 3-prong receptacle should be located within reach of the cooktop's four-foot power cord.

! IMPORTANT !

FOR PERSON SAFETY, THIS APPLIANCE MUST BE PROPERLY GROUNDED.

The power cord of this appliance is equipped with a three-prong (grounding) plug which mates with a standard three-prong grounding wall receptacle to minimize the possibility of electric shock hazard from this appliance.

The customer should have the wall receptacle and circuit checked by a qualified electrician to make sure the receptacle is properly grounded and has correct polarity.

Where a standard two-prong wall receptacle is encountered, it is the personal responsibility and obligation of the customer to have it replaced with a properly grounded three-prong wall receptacle.

Do Not, Under Any Circumstances, Cut or Remove the Third (Ground) Prong from The Power Cord. Do not use an extension cord.

Grounding type
wall receptacle

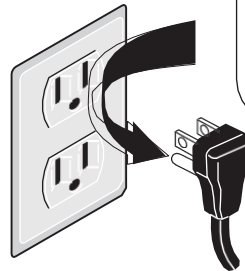

Do not, under any
circumstances, cut,
remove, or bypass

the grounding prong.
Power supply cord with
3-prong grounding plug

DESCRIPTION OF THE GAS COOKTOP

MODEL:WE-APG3021BS





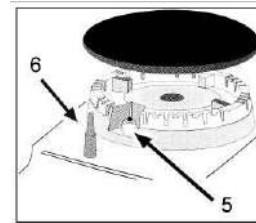

MODEL:WE-APG8051S

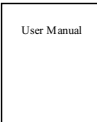

1. Triple ring wok burner: (12000btu)
2. Rapid burner: (8500btu)
3. Semi-rapid burner: (6000btu)
4. Auxiliary Burners:(3400btu)
5. Ignitor for Gas Burners (only on certain models)
6. Safety Device (only on certain models) - Activates if the flame accidentally goes out (spills, drafts, etc.), interrupting the delivery of gas to the burner.
7. Control Knobs for Gas Burners

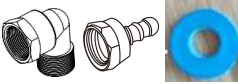
PARTS MAY INCLUDED

Part Name	Picture	Quantity (pcs/set)
User manual		1 pcs
Bracket		4 pcs
Screw		4 pcs
Gas-pipe bend		1 set
LPG Nozzle		1 set
Sponge		1 set

MATERIALS YOU MAY NEED

Joint Sealant Pipe Fittings Shut-Off Valve, Approved Flexible Gas Line

PRESSURE REGULATOR

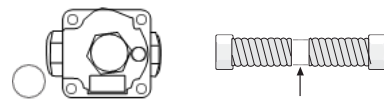

Note: Purchase new line, do not use previously used flexible gas line.

DIMENSIONS AND CLEARANCE

To ensure accuracy, it is best to make a template for the opening.

Make sure the sides of the opening are parallel and the rear and front cuts are exactly perpendicular to the sides.

Make sure the wall coverings, countertop and cabinets around the cooktop can withstand heat (up to 200°F) generated by the cooktop.

MODEL: WE-APG3021BS



PRODUCT DIMENSIONS: 11.4x19.7 in (29x50cm)

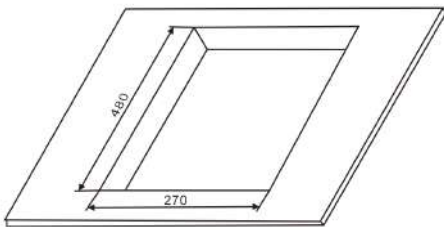

CUT OUT DIMENSIONS: 10.6x18.9 in (27x48cm)

MODEL: WE-APG8051S



PRODUCT DIMENSIONS: 30x19.7 in (76x50cm)

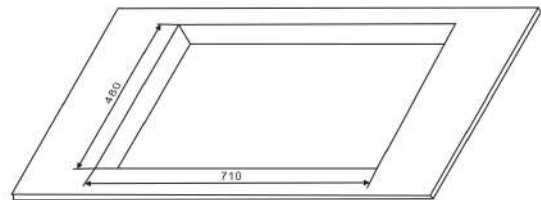

CUT OUT DIMENSIONS: 28x18.9 in (71x48cm)

CLEARANCES REQUIRED WHEN FITTING THE COOKTOP WITH A COOKER HOOD ABOVE

bracket position

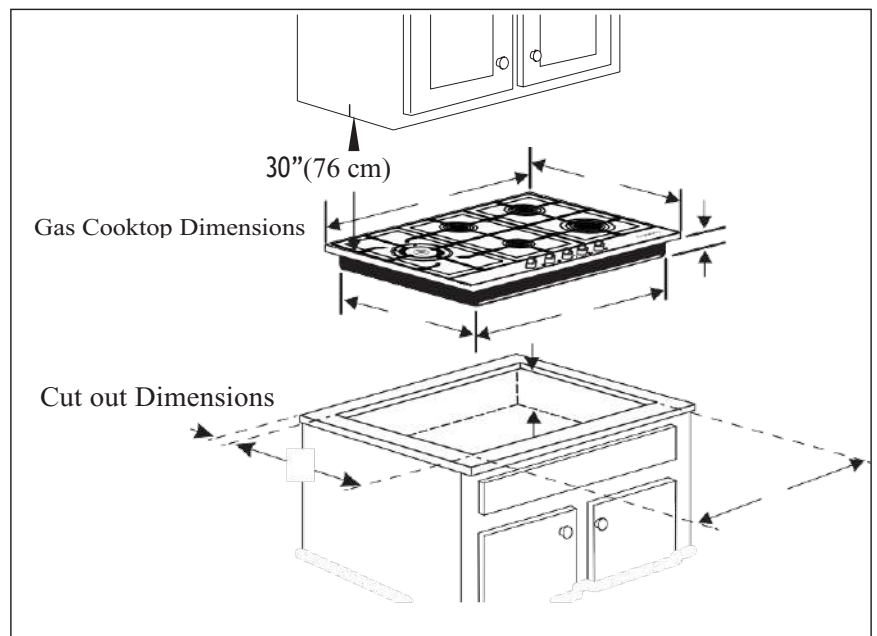
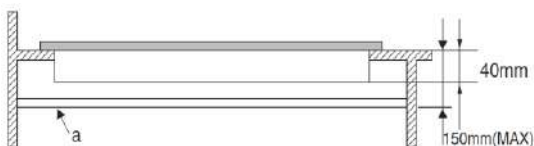
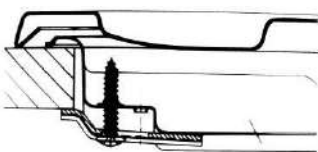

INSTALLATION OPTIONS

INSTALLING THE COOKTOP

- A. Remove the screws on the sides of the cooktop burner box. Use those screws to attach the side mounting brackets.
- B. Insert the cooktop centered into the cutout opening. Make sure the front edge of the countertop is parallel to the cooktop. Check clearances at the front, back and sides. Secure the hold-down bracket to the cabinet sides with screws.

INSTALL PRESSURE REGULATOR

- A. Screw the regulator onto the burner box bottom pipe connection. Make sure the top of the regulator is facing toward the cabinet front and the arrow on the back of the regulator points to the cooktop.
- B. Complete the connection between the regulator and the shut-off valve.
- C. Before testing for leaks, make sure all burner knobs are in the OFF position. After connecting the cooktop to gas, check system for leaks with a manometer. If a manometer is not available, turn the gas supply on to the cooktop and use a liquid leak detector at all joints and connections to check for leaks. Tighten all connections if necessary to prevent gas leakage in the cooktop or supply line.

The pressure regulator has two female threads 1/2" NPT. The regulator shall be installed properly in order to be accessible when the appliance is installed in its final position.

Manifold pressure should be checked with a manometer and comply with the values indicated below.

Natural Gas->5.0" W.c.P

L P/Propane-> 10.0" W.c.P

STEP 1: PRESSURE REGULATOR

The pressure regulator is a convertible type pressure regulator for use with Natural Gas at a nominal outlet pressure of 5" w.c. or LP gas at a nominal outlet pressure of 10" w.c. and it is pre-assembled from the factory to operate with one of these gas pressure as indicated in the labels affixed on the appliance, package, and instruction booklet.

To convert the regulator for use with other liquid propane LP gas:

1. Unscrew the front cap of the regulator (as seen below.) Inside the cap is a screw. By hand, remove the screw to reveal a spring. Reapply the screw to the cap with the spring revealed.
2. With the spring sticking out of the cap, reapply back to the regulator.
3. Using a manometer, double check pressure is at 10w.c. If you need to adjust the pressure, screw or unscrew the black spacer where the spring is located.

HOW TO SET LP AND NG MODE

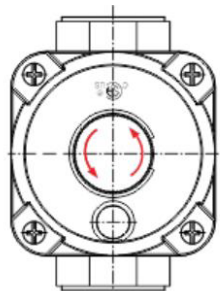

Take out the screw to check it is LP mode or NG mode

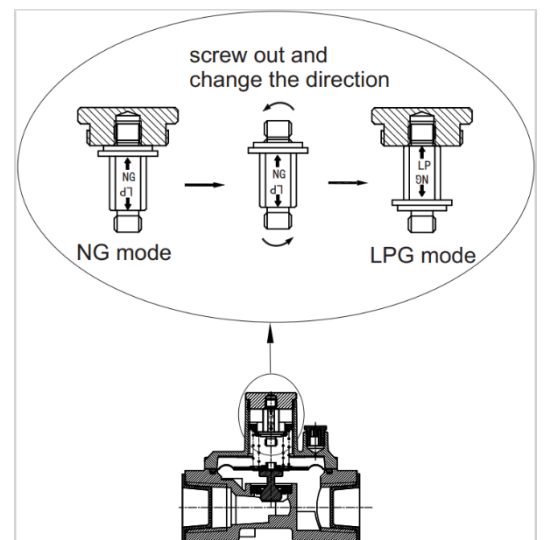

POWER SUPPLY LOCATIONS

Gas supply: These cooktops are shipped from the factory set for either natural gas or LP gas. Check to be sure you have the correct cooktop for the type of gas being used.

- The pressure regulator must be connected in series with the manifold of the cooktop and must remain in series with the supply line regardless of type of gas being used.
- The natural gas model is designed to operate at 5” water column pressure. A regulator is required at the natural gas source to provide a minimum of 5” water column to the cooktop regulator
- The liquid propane model is designed to operate at 10” water column pressure. A regulator is required at the LP source to provide a minimum of 10” water column to the cooktop regulator. For easy of installation, and if local codes permit, the gas supply line into the cooktop should be 1/2” or 3/4” ID flexible metal appliance connector, three to five feet long.

NOTE: Purchase new flexible line. DO NOT USE OLD, PREVIOUSLY USED FLEXIBLE LINE

The gas inlet is located on the bottom of the bottom box;.

Pressure Regulator Installation

- A: Cooktop gas pipe bend
- B: Pressure Regulator
- C: Gas fitting

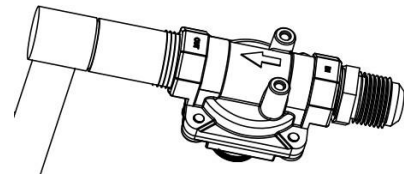
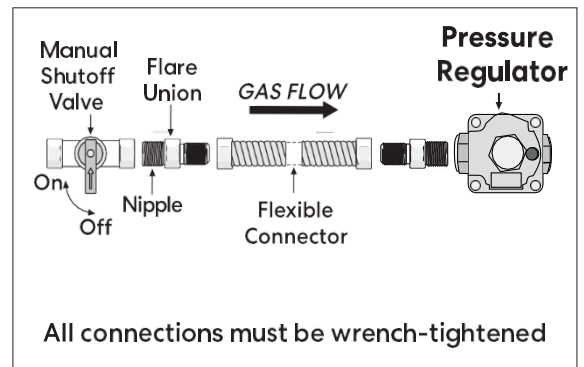
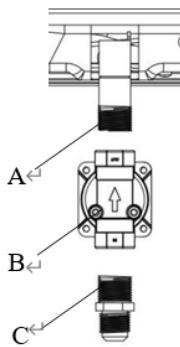

First, make sure that the pressure regulator arrow points toward the cooktop air pipe joint, and then fasten the pressure regulator to the cooktop air pipe.

Then install the gas fitting on the other side of the pressure regulator.

The cooktop valve is in the closed state, open the air supply valve, coated the connector with moderate amounts of soapy water, if there is air bubbles that it means there is leakage, tighten the connector and test again. If repeat 3 to 4 times and there is still air bubbles, notify professionals to deal with it.





How to Use Your Gas hob

The position of the corresponding gas burner is indicated on each control knob.

Gas Burners

The burners are different in size and power. Choose the most appropriate one for the diameter of the cookware being used.

The burner can be regulated with the corresponding control knob by using one of the following settings:

- OFF
-   High
-  Low

On those models fitted with a safety device

The knob must be pressed for about 6 seconds until the flame is lighted and warmed up.

On those models fitted with an igniter

The electric ignition button, identified by the  symbol, must be pressed first, then the corresponding knob is pushed and turned in the counter-clockwise direction to the "High" setting.

To light a burner: Simply press the corresponding knob and turn it in the counter-clockwise direction to the High setting, keep press until the burner is lighted.

Caution: If the flame goes out accidentally, turn off the gas with the control knob and try to light it again at least 1 minute later.

To turn off a burner: Turn the knob in the clockwise direction until it is stopped (it should be on the "•" setting).

How to Keep Your Gas hob in Shape

Before cleaning or performing maintenance on your gas hob, disconnect it from the electrical power supply (included battery power).

To extend the lifespan of the gas hob, it is absolutely indispensable that it is cleaned carefully, thoroughly and usually, please keep in mind to the following:

- The enameled parts and the glass top, must be washed with warm water without using abrasive powders or corrosive substances which could ruin them;
- The removable parts of the burners should be washed usually with warm water and soap, make sure to remove caked-on substances;
- Automatic igniter pin, the end must be cleaned carefully and usually, make sure ignition keep working normally.
- Stainless steel top plate and other steel parts can be stained if keep touch with high concentration calcareous water or corrosive detergents (containing phosphorus). To extend the lifespan, we advise

these parts be rinsed thoroughly with water and dry them by blowing, It is a good idea to clean up any spills too.

- After glass hob working, the surface must be cleaned by a damp cloth to remove dust or food residues. Glass surface should be cleaned regularly with warm water and non-corrosive detergent.

First, to remove all food residues or greases with a cleaning scraper, e.g.

Cleaning scraper (not supplied).

While the cooking surface is warm, clean it with a suitable cleaning product and paper towels, then rub with a damp cloth and dry surface. Such as aluminum foil, plastic items, objects made of synthetic material, sugar or foods with a high sugar content that have been melted onto the surface, it must be removed immediately.

While the cooking surface is still hot, clean it with a scraper and a transparent protective film which prevent to make more dirt. This also protect the surface from damage caused by food with a high sugar content.

Do not use abrasive sponges or cleaning products, these holds true for chemically aggressive cleaners, like oven sprays and stain removers;

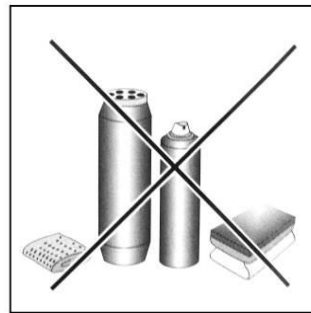
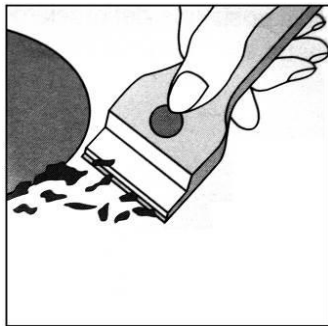

- Cleaning the grill/pan support, it is recommended to clean it while it is still hot. To move grill away from the hob and put it in sink, remove the food residues or grease first, after grill has cooled, rinse it with water.

Greasing the Gas Valves

Over time, the gas valves may be stuck, and it is difficult to turn on/off. For this case, stop to use the gas cooktop and call a technician authorized by the manufacturer to repair.

Circuit Diagram

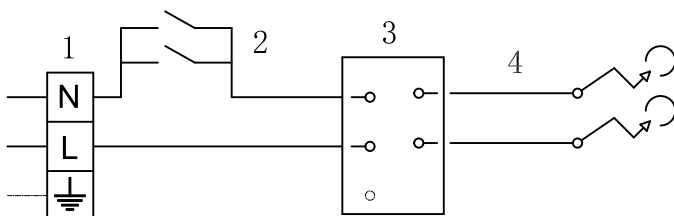

1. TERMINAL BLOCK
2. VALVE
3. IGNITER
4. IGNITION NEEDLE

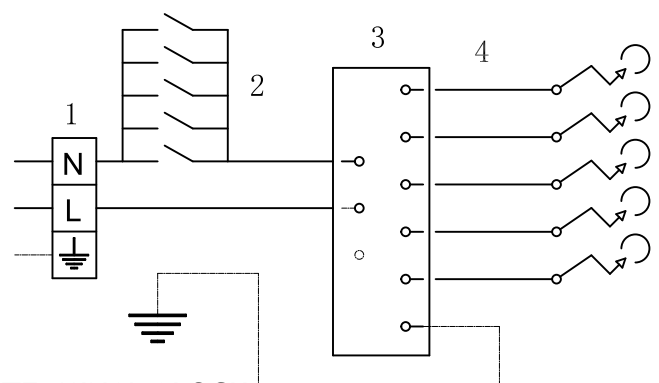

1. TERMINAL BLOCK
2. VALVE
3. IGNITER
4. IGNITION NEEDLE

Practical Advice

Practical Advice on Using the Burners

For best performance, follow these general guidelines:

- Use the appropriate cookware for each burner (see table) in order to prevent the flame to reach the side of the pot or pan;
- Always use cookware with a flat bottom and keep the lid on;
- When the contents come to a boil, turn the knob to "Low".

Burners	Wok	Rapid	Semi-Rapid	Auxiliary
Ø pans in cm	24-26	22-24	16-20	10-14

Ø Cookware bottom diameter (cm)

To identify the type of burner, refer to the designs in the section entitled, "Burner and Nozzle Specifications".

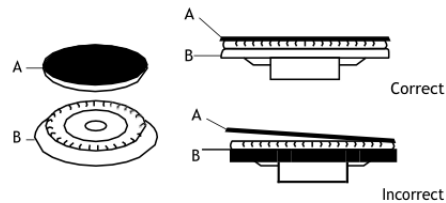
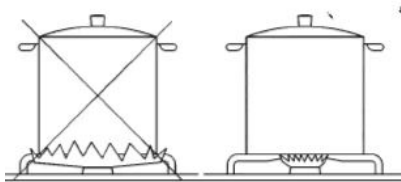

Always check that the burner caps are properly installed before operation

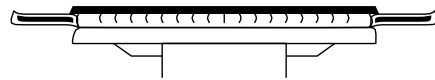

Verify that the flame of the worktop burners is completely blue and with a regular aspect as shown below:



Do not place anything, e.g., flame tamer, asbestos mat, between pan and pan support as serious damage to the appliance may result.



Do not remove the pan support and enclose the burner with a wok stand as this will concentrate and deflect heat onto the hotplate.



Do not use large pots or heavy weights which can bend the pan support or deflect flame onto the hotplate.



Locate pan centrally over the burner so that it is stable and does not overhang the appliance.



Use only a wok support supplied or recommended by the manufacturer of the appliance.

TROUBLE SHOOTING

If you find the gas hob cannot work suddenly or cannot work properly. Before calling customer service for assistance, let us check what we can do.

First of all, check and confirm there have no interruptions to the gas and electrical supplies, particularly, if the gas valves keeping turn on.

Servicing of the hotplates must only be done by an authorized service representative (see back of this booklet) and the hotplate must not be modified. Power must be disconnected before any servicing or maintenance is conducted.

Problem	Probable cause	Solution
Not ignited	No Spark	Check the electricity supply
	The burner lid is badly assembled	Assemble the lid correctly
	The gas supply is closed	Open the gas supply completely
Badly ignited	The gas supply is not completely open.	Open the gas supply completely
	The burner lid is badly assembled	Assemble the lid correctly
	The ignition plug is contaminated With alien substance	Wipe alien substance with a dry cloth
	The burners are wet	Dry the burners lids carefully
	The holes in the flame spreader are clogged	Clean the flame spreader
Noise made when combusted and ignited	The burner lid is badly assembled	Assemble the lid correctly
Flame goes out when in use.	The flame supervision device is contaminated with alien	Clean the supervision device
	Product being cooked has boiled over and extinguished	Turn off burner knob. Wait one minute and reignite zone
	A strong draught may have blown the flame out	Turn off zone and check cooking area for draught Such as open windows. Wait one minute and reignite zone
Yellow Flame	The holes in the flame spreader are clogged	Clean the flame spreader
	Different gas is used	Check the gas used
Unstable Flame	The burner lid is badly assembled	Assemble the lid correctly
Gas Smell	Gas leakage	Stop using the product and close the middle valve. Open the window to ventilate. Contact our service centre by using a phone outside.

Burners and Nozzle Specifications

Adapting the Gas hob for Different Types of Gas

Burner	NG		LPG	
	Power (btu/hr.)	Nozzle (mm)	Power (btu/hr.)	Nozzle (mm)
Auxiliary (Small) (A)	3400	0.81	3400	0.57
Semi rapid (Medium)	6000	1.13	6000	0.75
Rapid (R)	8500	1.30	8500	0.89
Triple Ring (TR)	12000	1.55	12000	1.06
Supply pressures	5.0" W.c.P		10.0" W.c.P	

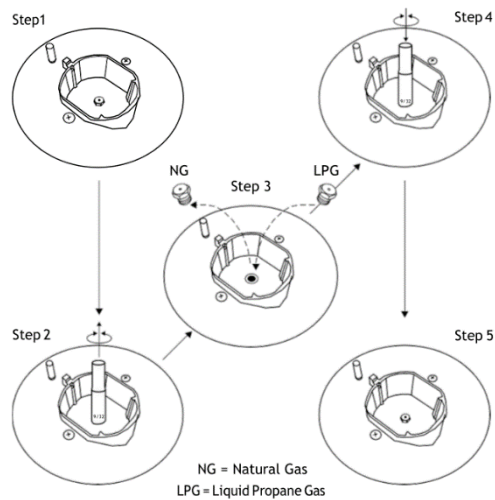
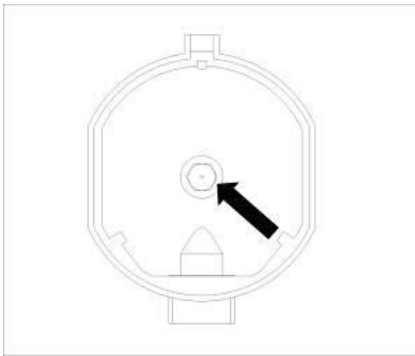

SURFACE BURNERS

1. To replace the nozzles of the surface burners, lift up the burners and unscrew the nozzles shipped with the range using a 7 mm (socket wrench).
2. Replace nozzles using the conversion set supplied with the range. Each nozzle has a number indicating its flow diameter printed on the body.

After you have converted the gas hob to another gas type, make sure you have placed a label containing that information on the appliance.

Valve & Flame adjustment

Valve adjustment

Valve adjustment should be done with the control knob set at Burner ON saving flame position. Remove the knob, and adjust the flame with a tiny screwdriver (see below).

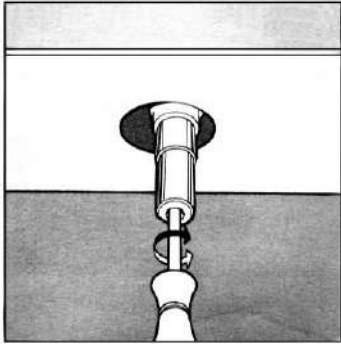

To remove the knob to adjust the flame

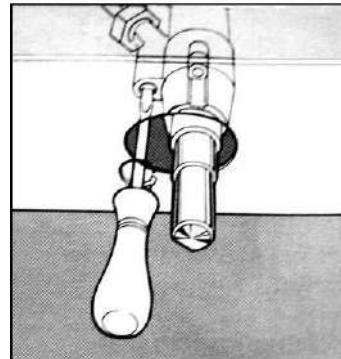

To remove the knob and panel to adjust the flame

To check the adjusted flame: heat the burner at full open position for 10 minutes. Then turn the knob into the saving setting. The flame should not extinguish nor move to the nozzle. If it extinguishes or moves to the nozzle, readjust the valves.

Flame selection

As the burners are adjusted correctly, the flame should be light blue, and the inner flame should be clear. The size of flame depends on the position of the related control knob.

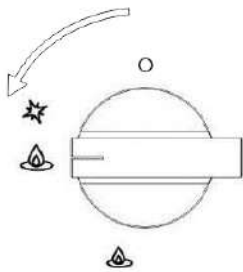

-Burner ON, large flame

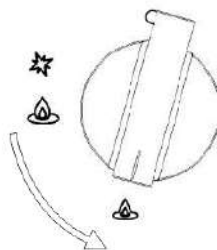

-Burner ON, small flame (saving mode)

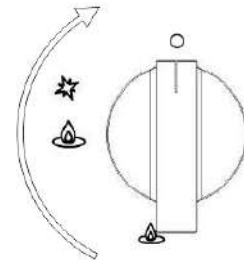

-Burner OFF

See above for various operating options (flame size selection); the burner should be set at a large flame during the initial phase of cooking, it makes food boil quickly. Then should turn knob to the saving flame position to maintain the cooking. It is possible to adjust the flame size stepless.

It is prohibited to adjust the flame between the Burner OFF and Burner ON large flame positions.

High quantity of energy can be conserved if the hob is used correctly, parameters are designed correctly, and appropriate cookware is used.

It is a prerequisite for efficient and energy-saving operation of hob that the burners are kept clean at all times (in particular the flame slots and nozzles).