

EN

BM341M3DBGH/744400

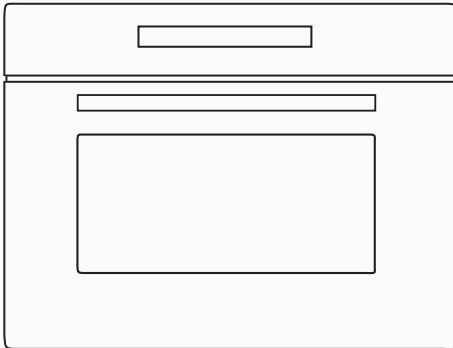

MICROWAVE OVEN

DEAR CUSTOMER

We sincerely thank you for your purchase. We believe you will soon find ample evidence that you can really rely on our products. To make the use of the appliance easier, we attach these comprehensive instruction manual.

The instructions should aid you in getting familiar with your new appliance. Please, read them carefully before using the appliance for the first time.

In any case, please make sure the appliance was supplied to you undamaged. Should you identify and transport damage, contact your sales representative or the regional warehouse from where the product was delivered. You will find the telephone number on the receipt or delivery report.



We wish you a lot of pleasure with your new household appliance.

The appliance for household use for heating food and beverages using electromagnetic energy, for indoor use only.

INSTRUCTIONS FOR USE

Carefully read the instructions and save them for future reference.

These instructions are intended for the user. They describe the cooker and how to use it. They also apply to different types of appliances, therefore you may find some descriptions of functions that may not apply to your appliance.

PRECAUTIONS TO AVOID POSSIBLE EXPOSURE TO EXCESSIVE MICROWAVE ENERGY

1. Do not attempt to operate this oven with the door open since this can result in harmful exposure to microwave energy. It is important not to break or tamper with the safety interlocks.
2. Do not place any object between the oven front face and the door or allow soil or cleaner residue to accumulate on sealing surfaces.
3. **WARNING:** If the door or door seals are damaged, the oven must not be operated until it has been repaired by a competent person.

ADDENDUM

If the apparatus is not maintained in a good state of cleanliness, its surface could be degraded and affect the lifespan of the apparatus and lead to a dangerous situation.

IMPORTANT SAFETY INSTRUCTIONS

WARNING

To reduce the risk of fire, electric shock, injury to persons or exposure to excessive microwave oven energy when using your appliance, follow basic precautions, including the following:

- **Warning:** Liquids and other foods must not be heated in sealed containers since they are liable to explode.
- **Warning:** It is hazardous for anyone other than a competent person to carry out any service or repair operation that involves the removal of a cover which gives protection against exposure to microwave energy.
- This appliance can be used by children aged from 8 years and above and persons with reduced physical, sensory or mental capabilities or lack of experience and knowledge if they have been given supervision or instruction concerning use of the appliance in a safe way and understand the hazards involved. Children shall not play with the appliance. Cleaning and user maintenance shall not be made by children unless they are older than 8 and supervised.
- Keep the appliance and its cord out of reach of children less than 8 years.
- Only use utensils that are suitable for use in microwave ovens.
- The oven should be cleaned regularly and any food deposits should be removed.

- Read and follow the specific: "PRECAUTIONS TO AVOID POSSIBLE EXPOSURE TO EXCESSIVE MICROWAVE ENERGY".
- When heating food in plastic or paper containers, keep an eye on the oven due to the possibility of ignition.
- If smoke is emitted, switch off or unplug the appliance and keep the door closed in order to stifle any flames.
- Do not overcook food.
- Do not use the oven cavity for storage purposes. Do not store items, such as bread, cookies, etc. inside the oven.
- Remove wire twist-ties and metal handles from paper or plastic containers/bags before placing them in the oven.
- Install or locate this oven only in accordance with the installation instructions provided.
- Eggs in the shell and whole hard-boiled eggs should not be heated in microwave ovens since they may explode, even after microwave heating has ended.
- This appliance is intended to be used in household and similar applications such as:
 - staff kitchen areas in shops, offices and other working environments;
 - by clients in hotels, motels and other residential type environments;
 - farm houses;

-bed and breakfast type environments.

- If the supply cord is damaged, it must be replaced by the manufacturer, its service agent or similarly qualified persons in order to avoid a hazard.
- Do not store or use this appliance outdoors.
- Do not use this oven near water, in a wet basement or near a swimming pool.
- The temperature of accessible surfaces may be high when the appliance is operating. The surfaces are liable to get hot during use. Keep cord away from heated surface, and do not cover any vents on the oven.
- Do not let cord hang over edge of table or counter.
- Failure to maintain the oven in a clean condition could lead to deterioration of the surface that could adversely affect the life of the appliance and possibly result in a hazardous situation.
- The contents of feeding bottles and baby food jars shall be stirred or shaken and the temperature checked before consumption, in order to avoid burns.
- Microwave heating of beverages can result in delayed eruptive boiling, therefore care must be taken when handling the container.
- The appliance is not intended for use by persons (including children) with reduced physical, sensory or mental capabilities, or lack of experience and knowledge, unless they have been given supervision or instruction concerning use of the

appliance by a person responsible for their safety.

- Children should be supervised to ensure that they do not play with the appliance.
- The appliances are not intended to be operated by means of an external timer or separate remote-control system.
- Accessible parts may become hot during use. Young children should be kept away.
- Steam cleaner is not to be used.
- During use the appliance becomes hot. Care should be taken to avoid touching heating elements inside the oven.
- Only use the temperature probe recommended for this oven.(for ovens provided with a facility to use a temperature-sensing probe.)
- **WARNING:** The appliance and its accessible parts become hot during use. Care should be taken to avoid touching heating elements. Children less than 8 years of age shall be kept away unless continuously supervised.
- The microwave oven must be operated with the decorative door open.(for ovens with a decorative door.)
- Surface of a storage drawer can get hot.
- The microwave oven is intended for heating food and beverages.Drying of food or clothing and heating of warming pads,slippers,sponges,damp cloth and similar may lead to risk of injury,ignition or fire.

- The appliance shall not be cleaned with a steam cleaner.
- Care should be taken not to displace the turntable when removing containers from the appliance.
- The appliance must not be installed behind a decorative door in order to avoid overheating.
- **WARNING:** When the appliance is operated in the combination mode, children should only use the oven under adult supervision due to the temperatures generated.

READ CAREFULLY AND KEEP FOR FUTURE REFERENCE

TO REDUCE THE RISK OF INJURY TO PERSONS GROUNDING INSTALLATION

DANGER

Electric Shock Hazard

Touching some of the internal components can cause serious personal injury or death. Do not disassemble this appliance.

WARNING

Electric Shock Hazard Improper

use of the grounding can result in electric shock.

Do not plug into an outlet until appliance is properly installed and grounded.

This appliance must be grounded. In the event of an electrical short circuit, grounding reduces the risk of electric shock by providing an escape wire for the electric current.

This appliance is equipped with a cord having a grounding wire with a grounding plug. The plug must be plugged into an outlet that is properly installed and grounded.

Consult a qualified electrician or serviceman if the grounding instructions are not completely understood or if doubt exists as to whether the appliance is properly grounded. If it is necessary to use an extension cord, use only a 3-wire extension cord.

1. A short power-supply cord is provided to reduce the risks resulting from becoming entangled in or tripping over a longer cord.

2. If a long cord set or extension cord is used:
 - 1)The marked electrical rating of the cord set or extension cord should be at least as great as the electrical rating of the appliance.
 - 2)The extension cord must be a grounding-type 3-wire cord.
 - 3)The long cord should be arranged so that it will not drape over the counter top or tabletop where it can be pulled on by children or tripped over unintentionally.

CLEANING

Be sure to unplug the appliance from the power supply.

- Clean the cavity of the oven after using with a slightly damp cloth.
- Clean the accessories in the usual way in soapy water.
- The door frame and seal and neighbouring parts must be cleaned carefully with a damp cloth when they are dirty.
- Do not use harsh abrasive cleaners or sharp metal scrapers to clean the oven door glass since they can scratch the surface, which may result in shattering of the glass.
- Cleaning Tip---For easier cleaning of the cavity walls that the food cooked can touch: Place half a lemon in a bowl, add 300ml (1/2 pint) water and heat on 100% microwave power for 10 minutes. Wipe the oven clean using a soft, dry cloth.

CAUTION

Personal Injury Hazard

It is hazardous for anyone other than a competent person to carry out any service or repair operation that involves the removal of a cover which gives protection against exposure to microwave energy.

See the instructions on "Materials you can use in microwave oven or to be avoided in microwave oven."

There may be certain non-metallic utensils that are not safe to use for microwaving. If in doubt, you can test the utensil in question following the procedure below.

Utensil Test:

- Fill a microwave-safe container with 1 cup of cold water (250ml) along with the utensil in question.
- Cook on maximum power for 1 minute.
- Carefully feel the utensil. If the empty utensil is warm, do not use it for microwave cooking.
- Do not exceed 1 minute cooking time.

Materials you can use in microwave oven

Utensils	Remarks
Browning dish	Follow manufacturer's instructions. The bottom of browning dish must be at least 3/16 inch (5mm) above the turntable. Incorrect usage may cause the turntable to break.
Dinnerware	Microwave-safe only. Follow manufacturer's instructions. Do not use cracked or chipped dishes.
Glass jars	Always remove lid. Use only to heat food until just warm. Most glass jars are not heat resistant and may break.
Glassware	Heat-resistant oven glassware only. Make sure there is no metallic trim. Do not use cracked or chipped dishes.
Oven cooking bags	Follow manufacturer's instructions. Do not close with metal tie. Make slits to allow steam to escape.
Paper plates and cups	Use for short-term cooking/warming only. Do not leave oven unattended while cooking.
Paper towels	Use to cover food for reheating and absorbing fat. Use with supervision for a short-term cooking only.
Parchment paper	Use as a cover to prevent splattering or a wrap for steaming.
Plastic	Microwave-safe only. Follow the manufacturer's instructions. Should be labeled "Microwave Safe". Some plastic containers soften, as the food inside gets hot. "Boiling bags" and tightly closed plastic bags should be slit, pierced or vented as directed by package.
Plastic wrap	Microwave-safe only. Use to cover food during cooking to retain moisture. Do not allow plastic wrap to touch food.
Thermometers	Microwave-safe only (meat and candy thermometers).
Wax paper	Use as a cover to prevent splattering and retain moisture.

Materials to be avoided in microwave oven

Utensils	Remarks
Aluminum tray	May cause arcing. Transfer food into microwave-safe dish.
Food carton with metal handle	May cause arcing. Transfer food into microwave-safe dish.
Metal or metal-trimmed utensils	Metal shields the food from microwave energy. Metal trim may cause arcing.
Metal twist ties	May cause arcing and could cause a fire in the oven.
Paper bags	May cause a fire in the oven.
Plastic foam	Plastic foam may melt or contaminate the liquid inside when exposed to high temperature.
Wood	Wood will dry out when used in the microwave oven and may split or crack.

NAMES OF OVEN PARTS AND ACCESSORIES

(In case of any differences between the appliance and the pictures in this manual, the product shall prevail.)

Remove the oven and all materials from the carton and oven cavity. Your oven comes with the following accessories:



Glass Tray



Turntable Ring Assembly



Instruction Manual



Turntable Shaft

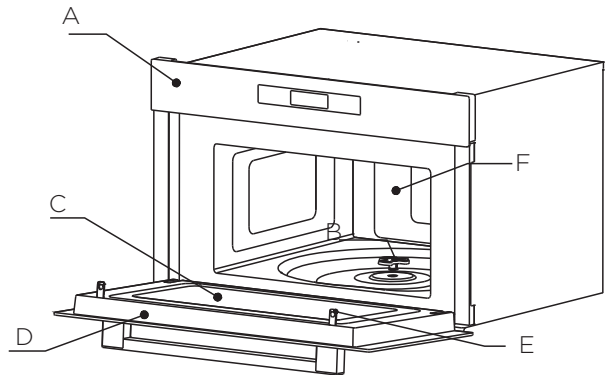

- | | |
|-----------------------|----------------------------|
| A) Control pane | D) Door assembly |
| B) Turntable shaft | E) Safety interlock system |
| C) Observation window | F) Oven cavity |

TURNTABLE INSTALLATION

Cleaning the cooking compartment and putting the turntable in place. For new installations, make sure all packaging and shipping tape has been removed from the turntable shaft. Before using the appliance to prepare food for the first time, you will need to put the turntable in place correctly. You must clean the cooking compartment and accessories.

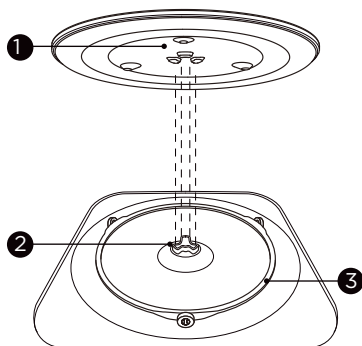

How to put the turntable in place:

1. Place the turntable ring assembly ③ into the recess in the cooking compartment.
2. Place the glass tray ① on the turntable ring assembly ③. Fit the raised, curved lines in the center of the glass tray bottom between the three spokes of the shaft. Make sure that the glass tray ① engages in the turntable shaft ② in the centre of the cooking compartment floor. The rollers on the shaft should fit inside the turntable bottom ridge.

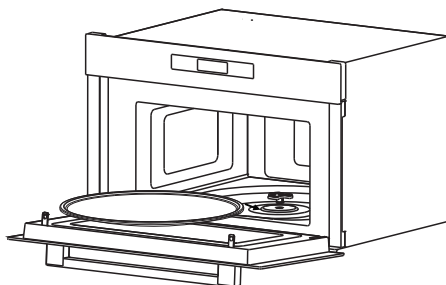

Note:

1. Never use the appliance without the turntable. Make sure that it is properly engaged. The turntable can turn clockwise or anti-clockwise.
2. Never place the glass tray upside down. The glass tray should never be restricted.
3. Both glass tray and turntable ring assembly must always be used during cooking.
4. All food and containers of food are always placed on the glass tray for cooking.
5. Never restrict the movement of the turntable.
6. If glass tray or turntable ring assembly cracks or breaks, contact your nearest authorized service center.



Microwave

microwave



Function

auto defrost



Clock/Kitchen Timer

multi time



Auto Menu

auto bake



Lock/Cancel

pause | stop





Start/+30Sec./Confirm



quick | start

OPERATION INSTRUCTION

1. Setting the Clock



- 1) Press “” once and then “00:00” will display.
- 2) Move the slider or press “+” or “-” to set the hour figures.
The time should be within 0-23.
- 3) Press “” to confirm.
- 4) Move the slider or press “+” or “-” to set the minute figures.
The time should be within 0-59.
- 5) Press “” to confirm.

2. Kitchen Timer



- 1) Press “” twice and then “00:00” will display.
- 2) Move the slider or press “+” or “-” to set the time.
The time should be within 0:05~95:00
- 3) Press “” to confirm.

3. Microwave cooking



Power Level	100%	80%	50%	30%	10%
Display	P10	P8	P5	P3	P1

- 1) In waiting state, Press “” and then “P10” will display.
- 2) Press “” repeatedly to adjust the power level, 5 power levels are available.
- 3) Move the slider or press “+” or “-” to set the cook time.
- 4) Press “” to start cooking.

4. Defrost by Weight

- 1) Press “” once and then the screen will display “0.1kg”.
- 2) Move the slider or press “+” or “-” to set the weight.
- 3) Press “” to start defrosting.



5. Defrost by Time

- 1) Press “” twice and then the screen will display “1:00”.
- 2) Move the slider or press “+” or “-” to set the time.
- 3) Press “” to start defrosting.

NOTE:

when buzzer sounds, turn the food over.If no operation, the oven will continue working.

6. Speed cooking

- 1) In waiting state, press “  ” to cook food with 100% power level for 30 seconds. Each press on the same key can increase 30 seconds and the maximum time value is 95 minutes.
- 2) In standby mode, touch “ - ” once, and then Move the slider or press “ - ” or “ + ” to set a cooking time at 100% power.
Then touch “  ” to start cooking.

NOTE:

Speedy cooking cannot be set in defrost by weight, multi-stage and auto menu.

7. Lock Function for Children

You can use this function to prevent children from accidentally turning the oven on.

To activate the lock:

In waiting state, press and hold “  ” for three seconds. A long beep sounds and the locked icon will display.



To deactivate the lock:

In locked state, press and hold “  ” for three seconds. A long beep sounds.

8. Inquire function

- 1) If the clock has been set, the current time will display for three seconds by pressing “  ” in the cooking state.

9. Auto Menu

- 1) In waiting state, press “  ” or “ + ”, the screen will display “A-1”.
- 2) Press “  ” repeatedly to choose the menu you need. 8 auto menus are available.
- 3) Move the slider or press “ + ” or “ - ” to set the weight of the food.
- 4) Press “  ” to start cooking.

Note: For the menu “A-7”, please skip the step 4.

Auto menu Chart

Menu	Weight(g)	Display	Power
A-1 POTATO	1 (about 230g)	1	P10
	2 (about 460g)	2	
	3 (about 690g)	3	
A-2 MEAT	150g	150g	P8
	300g	300g	
	450g	450g	
	600g	600g	
A-3 FISH	150g	150g	P8
	250g	250g	
	350g	350g	
	450g	450g	
	650g	650g	
A-4 VEGETABLE	150g	150g	P10
	350g	350g	
	500g	500g	
A-5 BEVERAGE	1 cup(240g)	1	P10
	2 cup(480g)	2	
	3 cup(720g)	3	
A-6 PASTA	50g(cold water 450g)	50g	P8
	100g(cold water 800g)	100g	
	150g(cold water 1200g)	150g	
A-7 POPCORN	100g	100g	P10
A-8 PIZZA	200g	200g	P10
	400g	400g	

Installation and connection

Installation and connection

- This appliance is only intended for domestic use.
- This oven is intended for built-in use only. It is not intended for counter-top use or for use inside a cupboard.
- Please observe the special installation instructions.
- The appliance can be installed in a 60cm wide wallmounted cupboard.
- The appliance is fitted with a plug and must only be connected to a properly installed earthed socket.
- The mains voltage must correspond to the voltage specified on the rating plate.
- The socket must be installed and connecting cable must only be replaced by a qualified electrician. If the plug is no longer to accessible following installation, an all-pole disconnecting device must be present on the installation side with a contact gap of at least 3mm.
- Adapters, multi-way strips and extension leads must not be used. Overloading can result in a risk of fire.

The accessible surface may be hot during operation.



Built-in Oven Installation

The dimensions attached are in mm.
The units into which the appliance is fitted must be heatresistant up 95°C.
the minimum installation height is 850mm.

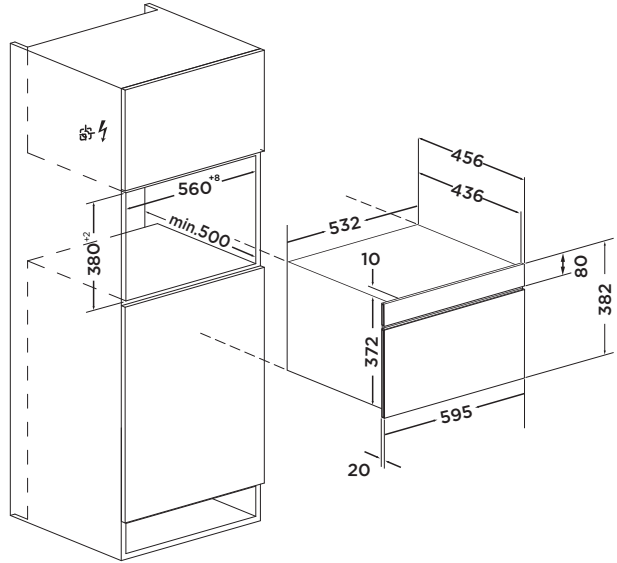

Building in

- Do not hold or carry the appliance by the door handle. The door handle cannot hold the weight of the appliance and may break off.
1. Carefully push the microwave into the box, making sure that it is in the centre.
 2. Open the door and fasten the microwave with the screws that were supplied.

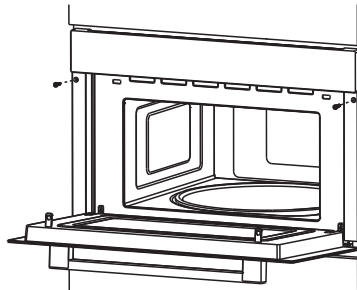

- Fully insert the appliance and centre it.
- Do not kink the connecting cable.
- Screw the appliance into place.

Important information with plug

Electrical connection

The appliance is fitted with a plug and must only be connected to a properly installed earthed socket. Only a qualified electrician who takes the appropriate regulations into account may install the socket or replace the connecting cable. If the plug is no longer accessible following installation, an all-pole isolating switch must be present on the installation side with a contact gap of at least 3 mm. Contact protection must be ensured by the installation.

Fuse protection: see instructions for use-technical data.

Important information without plug

The appliance is designed to be permanently installed with a three-pin power cord and may only be connected by a licensed expert in accordance with the connection diagram. Only a qualified electrician who takes the relevant regulations into account may replace the power cord. Do not use multiple plugs, power strips or extensions. Overloading causes a risk of fire.

If the connection is no longer accessible following installation, an all-pin isolating switch with a contact gap of at least 3 mm must be provided.

Connect the wires of the mains power cord in accordance with the following colour coding:

Green and yellow	Earth wire (E)
Blue	Neutral wire (N)
Brown	Live (L)

Great Britain and Australia:

Do not connect the appliance using a 13 A plug or protect it with a 13 A fuse. The appliance must be protected using a fuse that is rated 16 A or higher. The appliance must be disconnected from the power supply during all installation work. When the appliance is installed, protection must be provided against accidental contact in the future.

Specifications

Model: BM341M3DBGH/744400
Rated Voltage:220-240V- 50Hz
Rated Input Power (Microwave):.....1450W
Rated Output Power (Microwave):.....900W
Operating Frequency:2450MHz
Outside Dimensions:595mm(W)x382mm(H)x456mm(D)
Oven Capacity:34 litres
Weight:Approx. 22kg
Noise level:Lc < 63 dB (A)
Turntable diameter:345 mm

Energy Consumption

Product information for power consumption and maximum time to reach applicable low power mode.

Standby mode	0.8 W
--------------	-------

The maximum time needed for the microwave oven to automatically reach the applicable low power mode or condition. 20 minutes

Trouble shooting

Normal	
Microwave oven interfering TV reception	Radio and TV reception may be interfered when microwave oven operating. It is similar to the interference of small electrical appliances, like mixer, vacuum cleaner, and electric fan. It is normal.
Dim oven light	In low power microwave cooking, oven light may become dim. It is normal.
Steam accumulating on door, hot air out of vents	In cooking, steam may come out of food. Most will get out from vents. But some may accumulate on cool place like oven door. It is normal.
Oven started accidentally with no food in.	It is forbidden to run the unit without any food inside. It is very dangerous.

Trouble	Possible Cause	Remedy
Oven cannot be started.	(1). Power cord is not plugged in tightly.	Unplug. Then plug again after 10 seconds.
	(2). Fuse blowing or circuit breaker works.	Replace fuse or reset circuit breaker (repaired by professional personnel of our company)
	(3). Trouble with outlet.	Test outlet with other electrical appliances.
Oven does not heat.	(4). Door is not closed well.	Close door well.



According to Waste of Electrical and Electronic Equipment (WEEE) directive, WEEE should be separately collected and treated. If at any time in future you need to dispose of this product please do NOT dispose of this product with household waste. Please send this product to WEEE collecting points where available.

GUARANTEE & SERVICE

If you need information or if you have a problem, please contact the Gorenje Customer Care Centre in your country (you find its phone number in the worldwide guarantee leaflet). If there is no Customer Care Centre in your country, go to your local Gorenje dealer or contact the Service department of Gorenje domestic appliances.

Eventual mismatches in colour shades between different appliances or components within a single design line may occur due to various factors, such as different angles under which the appliances are observed, different coloured backgrounds, materials, and room illumination.

For personal use only!

Additional recommendations for cooking with microwave and useful advices can be found on web side:

<http://www.gorenje.com>

**WISHES YOU A LOT OF PLEASURE WHILE USING
YOUR APPLIANCE**

gorenje

We reserve the right to any changes and errors in the instructions for use.

www.gorenje.com