

DUAL HEAD FLOOD LIGHT INSTALLATION INSTRUCTIONS

WARNING: These products may represent a possible shock or fire hazard if improperly installed or attached in any way. Products should be installed in accordance with the owners manual, current electrical codes and/or the current National Electric Code (NEC).

PARTS INCLUDED

- (1) Flood light
- (1) Crossbar
- (2) J-Box mounting screws
- (2) Fixture mounting screws
- (2) Rubber washers
- (2) Canopy mounting nuts
- (2) Wire nuts
- (1) Round plate

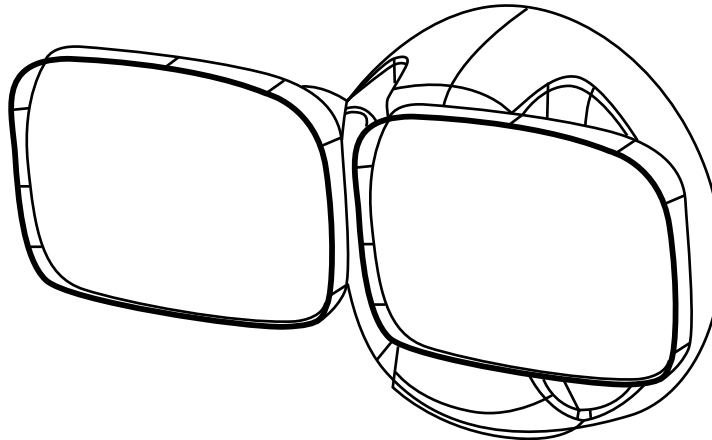

CAUTION, IMPORTANT SAFETY INSTRUCTIONS - Make sure the supply voltage is the same as the rated luminaire voltage. Do not install where marked operating temperatures exceed the ignition temperature of the hazardous atmosphere. Do not operate in ambient temperatures above those indicated on the luminaire nameplate. To avoid the risk of fire, explosion, or electric shock, this product should be installed, inspected and maintained by a qualified electrician only, in accordance with all applicable electrical codes. Be certain electrical power is OFF before and during installation and maintenance.

Note: Save these instructions for future reference.

For supply connections use wire rated for at least 90°C

CAUTION: Input 120VAC

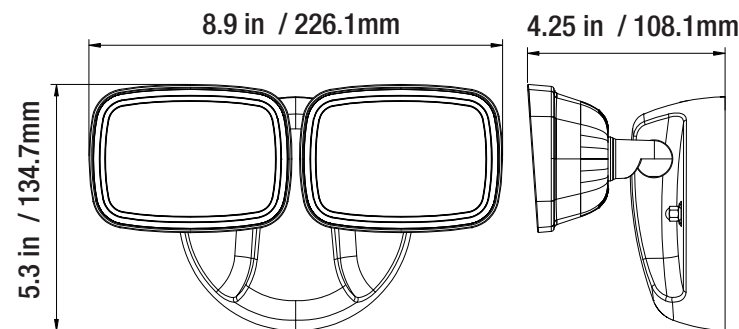

This device complies with part 15 of the FCC Rules. Operation is subject to the following two conditions: (1) This device may not cause harmful interference, and (2) this device must accept any interference received, including interference that may cause undesired operation. Note: This equipment has been tested and found to comply with the limits for a Class B digital device, pursuant to part 15 of the FCC Rules. These limits are designed to provide reasonable protection against harmful interference in a residential installation. This equipment generates, uses and can radiate radio frequency energy and, if not installed and used in accordance with the

instructions, may cause harmful interference to radio communications. However, there is no guarantee that interference will not occur in a particular installation. If this equipment does cause harmful interference to radio or television reception, which can be determined by turning the equipment off and on, the user is encouraged to try to correct the interference by one or more of the following measures: Reorient or relocate the receiving antenna. Increase the separation between the equipment and receiver. Connect the equipment into an outlet on a circuit different from that to which the receiver is connected. Consult the dealer or an experienced radio/TV technician for help.

LIMITED WARRANTY

This product is warranted to be free from defects in workmanship and materials for up to 5 years from date of purchase. If it fails to do so, please contact Feit Electric at info@feit.com or call 1-866 326-BULB (2852) for instructions on replacement. Do not return the product to the store.

For comments please write to:
 Feit Electric
 Customer Service Department
 4901 Gregg Road, Pico Rivera, CA 90660



WARNING: TURN OFF THE MAIN POWER AT THE CIRCUIT BREAKER BEFORE INSTALLING THE FIXTURE IN ORDER TO PREVENT POSSIBLE ELECTRIC SHOCK.

WARNING: This luminaire should be installed by qualified electrician. To avoid the risk of fire, explosion or electric shock, this product should be installed, inspected and maintained by a qualified electrician only, in accordance with all applicable electrical codes.

To avoid electric shock: Be certain electrical power is OFF before and during installation and maintenance.

Make sure the supply voltage is the same as the rated luminaire voltage. Do not operate in ambient temperatures above those indicated on the luminaire nameplate. Keep lens tightly closed when in operation.

Wall Mount Installation

1. Unscrew the canopy mounting nuts and remove the fixture crossbar (Fig A).

Fig A.

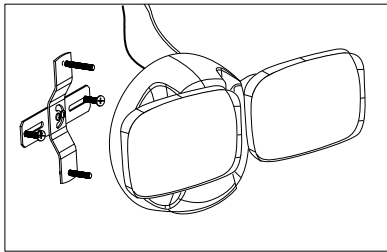

2. Pull the power supply wires to the side and install the fixture crossbar onto the J-box with the screws provided. Connect the ground wire to the ground screw on the crossbar (Fig B).

Fig B.

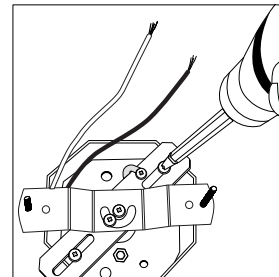

3. Using the wire nuts provided, connect the white fixture wire to the neutral house wire. Connect the black fixture wire to the power supply wire (Fig C).

Fig C.

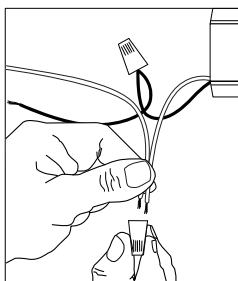

4. Adjust the crossbar fixture screws and tighten the center swivel screws. Insert the canopy holes through fixture mounting screws (Fig D).

Fig D.

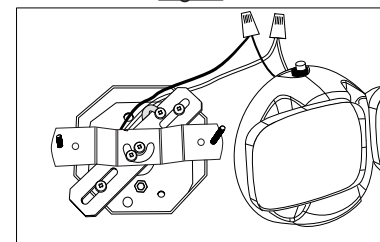

5. Position into place and secure fixture by installing the rubber washers and the canopy mounting nuts, then tighten the nuts (Fig E).

Fig E.

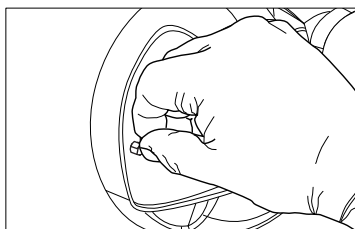

6. Caulk between the light fixture and the wall surface with a silicone sealant (not included).

4" Round External J-box Installation

1. Unscrew the canopy mounting nuts and remove the fixture crossbar (Fig A).

Fig A.

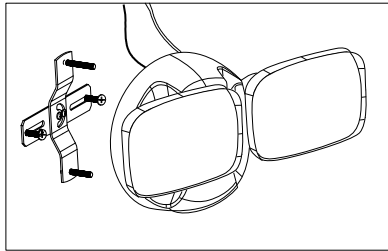

2. Before installing the round plate, add silicone sealant between the rear of the round plate and the J-box. Pull the power supply wires through the round plate and install the round plate along with crossbar, onto the J-box with the screws provided. Connect the ground wire to the ground screw on the crossbar (Fig B).

Fig B.

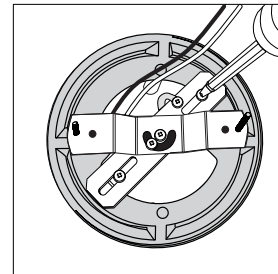

3. Using the wire nuts provided, connect the white fixture wire to the neutral house wire. Connect the black fixture wire to the power supply wire (Fig C).

Fig C.

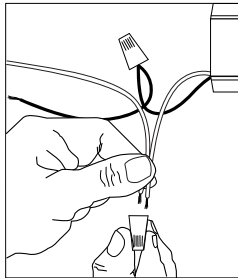

4. Adjust the crossbar fixture screws and tighten the center swivel screws. Before installing the fixture canopy, add silicone sealant between the front of the round plate and fixture canopy. Insert the fixture canopy holes through fixture mounting screws (Fig D).

Fig D.

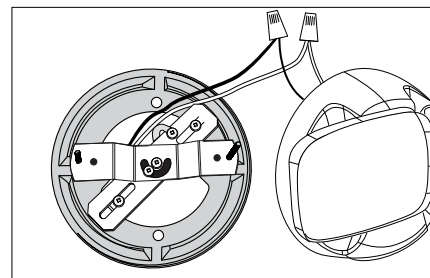

5. Position into place and secure fixture by installing the rubber washers and the canopy mounting nuts, then tighten the nuts (Fig E).

Fig E.

