



INSTALLATION MANUAL
FOR 24inch Single Zone Beverage Wine Cooler

MODEL NO.

EBS24BES

Thanks for buying our beverage center, Hope our advanced product will give your wine a different joyful taste. Before use, please read and follow all safety rules and operating instructions

WARNING

- This beverage center contains a flammable refrigerant (R600a). Keep away from open flames, sparks, cigarettes, or other ignition sources. Do not damage the refrigerant tubing.
 - Do not store or use gasoline or other flammable vapors and liquids near this or any other appliance.
 - Do not use electrical devices inside the beverage center unless they are recommended by the manufacturer.
 - Do not use an extension cord, adapter, or power strip. Connect the appliance to a properly grounded outlet.
 - Children should not play with or inside the beverage center. Keep packaging materials out of the reach of children.
 - If the supply cord is damaged, it must be replaced by the manufacturer, its service agent, or qualified personnel.
 - Do not touch the compressor or rear metal components; some surfaces may be hot.
 - Ensure that the power plug remains accessible after installation.
- **WARNING:** Keep ventilation openings, in the appliance enclosure or in the built-in structure, clear of obstruction.
- **WARNING:** Do not use mechanical devices or other means to accelerate the defrosting process, other than those recommended by the manufacturer.
- **WARNING:** Do not damage the refrigerant circuit.
- **WARNING:** Do not use electrical appliances inside the food storage compartments of the appliance, unless they are of the type recommended by the manufacturer.
- Do not store explosive substances such as aerosol cans with a flammable propellant in this appliance.
- **WARNING:** This refrigerating appliance is not suitable for freezing food.
- This appliance is intended to be used in household and similar applications such as
- staff kitchen areas in shops, offices and other working environments;
 - farm houses and by clients in hotels, motels and other residential type environments;
 - bed and breakfast type environments;

– catering and similar non-retail applications.

–**WARNING:** To avoid a hazard due to instability of the appliance, it must be fixed in accordance with the instructions.

PLEASE DON'T TRY TO PLUG INTO OR EXTENSION THE CABLE IN ANY CASE.

IMPORTANT SAFETY INSTRUCTIONS



To reduce the risk of fire, electrical shock, or injury when using your appliance, follow these basic precautions:

- Read all instructions before using the beverage center.

DANGER — ELECTRICAL SHOCK HAZARD

- Disconnect the beverage center from the power supply before servicing, cleaning, or replacing any components.
- Never remove the grounding prong from the plug.

WARNING — RISK OF FIRE / FLAMMABLE REFRIGERANT (R600a)

- This appliance uses a flammable refrigerant. Avoid ignition sources. If a leak is suspected, disconnect power, ventilate the room, and contact qualified service personnel.
- Do not damage the sealed system.

WARNING — INSTALLATION AND USE

- This appliance must be properly installed and grounded.
- Do not use an extension cord or multi-plug adapter.
- Do not store explosive materials (such as aerosol cans) inside or near the beverage center.
- This appliance is intended for indoor household use only.

CAUTION — HANDLING AND OPERATION

- Do not overload shelves and do not block internal air vents.
- Open the door slowly to prevent tipping or shelf movement.

NOTICE — CLEANING AND MAINTENANCE

- Disconnect power before cleaning. Do not use steam cleaners or flammable cleaning fluids.



CYCLOPENTANE

DANGER — Risk of fire or explosion. Flammable refrigerant used. To be repaired only by trained service personnel. Use only manufacturer-authorized service parts. Any repair equipment used must be designed for flammable refrigerants. Follow all manufacturer repair instructions. Do not puncture refrigerant tubing.

CAUTION — Risk of fire or explosion. Dispose of refrigerator properly in accordance with the applicable federal or local regulations. Flammable refrigerant used.

CAUTION — Risk of fire or explosion due to puncture of refrigerant tubing; follow handling instructions carefully. Flammable refrigerant used.

DANGER - Risque d'incendie ou d'explosion. Frigorigène inflammable utilisé. La réparation sera faite seulement par un personnel qualifié. Utiliser seulement des pièces de rechange autorisées par le fabricant. Tout équipement de réparation utilisé doit être conçu pour les frigorigènes inflammables. Suivre toutes les instructions de réparation du fabricant. Ne pas perforez la conduite de frigorigène.

ATTENTION - Risque d'incendie ou d'explosion. Éliminer convenablement conformément à la réglementation fédérale ou locale. Frigorigène inflammable utilisé.

ATTENTION - Risque d'incendie ou d'explosion dû à la perforation de la conduite de frigorigène. Suivre avec soin les instructions de manipulation. Frigorigène inflammable utilisé.

INSTALLATION INSTRUCTIONS

➤ **Before Using Your beverage center**

- Remove the exterior and interior packing.
- Before connecting the beverage center to the power source, let it stand upright for approximately 2 hours. This will reduce the possibility of a malfunction in the cooling system from handling during transportation.
- Clean the interior surface with lukewarm water using a soft cloth.
- This appliance is intended to be used in household and similar applications such as
 - staff kitchen areas in shops, offices and other working environments;
 - farm houses and by clients in hotels, motels and other residential type environments;
 - bed and breakfast type environments;
 - catering and similar non-retail applications.
- When disposing your appliance, please choose an authorized disposal site.

➤ **Installation of Your beverage center**

- This appliance is designed to be for freestanding installation or built-in (fully recessed) (Refer to sticker location the back of this appliance).
- **This appliance is intended to be used exclusively for the storage of wine and beverages.**
- Place your beverage center on a floor that is strong enough to support it when it is fully loaded. To level your beverage center, adjust the front leveling leg at the bottom of the beverage center.
- This beverage center uses a flammable refrigerant (R600a). Do not damage refrigerant tubing during transportation or installation. Keep the area free of ignition sources.
- Avoid locating the unit in moist areas.
- Connect the appliance to a properly grounded 120V~, 60Hz outlet. Do not use an extension cord, adapter, or power strip. Do not remove or bypass the grounding prong.

➤ **Attention**

- Store wine in sealed bottles;
- Do not overload the cabinet;
- Do not open the door unless necessary;
- Do not cover shelves with aluminum foil or any other shelf material which may prevent air circulation;
- Should the beverage center be stored without use for long periods it is suggested, after a careful cleaning, to leave the door ajar to allow air to circulate inside the cabinet in order to avoid possible formations of condensation, mold or odors.

➤ **Ambient Room Temperature Limits**

This appliance is designed to operate in ambient temperatures specified by its temperature class marked on the rating plate.

Class	Symbol	Ambient Temperatures range (°F)
Extended Temperate	SN	+ 50 to + 99
Temperate	N	+ 61 to + 99
Subtropical	ST	+ 61 to + 100
Tropical	T	+ 61 to + 109

OPERATING YOUR BEVERAGE CENTER AND SETTING THE TEMPERATURE CONTROL

□ OPERATING THE APPLIANCE

EBS24BES



1. Child Lock

When connected to the power, the default setting is unlocked. Press and hold the  button for 3 seconds to lock it. Press again and hold this button for 3 seconds to unlock.



2. Changing the Running Modes

Press to cycle through and select the desired operating mode (STD, ECO or DEMO).

When the appliance is switched on, the default mode is STD (Standard mode, no indicator light). The selected mode is shown on the display.

ECO Mode: This is an energy-saving mode where the interior light does not illuminate, and the display shows "Eco." After closing the door, the display and buttons will remain active for 5 seconds before turning off.

Demo Mode: This mode is for showroom display only and not for normal operation. The LED lighting works, but the appliance does not cool. The alarm symbol activates when the temperature has varied too high or low (HI or LO will also show in display to confirm this).

Sab Mode: To enter Sabbath mode, press and hold  for 3 seconds. The internal light will be turned off and opening the door will not cause the alarm to sound. 'Sb' is displayed and the control panel is locked except for the mode and power button. Press and hold  for 3 seconds to exit Sabbath and return to the standard mode.

3. Changing the LED light color

The LED light and button backlight default setting is Cold color when the appliance connects to power.

Press the  button. The LED light and button backlight alternate three colors: cold, blue and warm.

4. Changing the LED light mode







Touch this key to cycle through and select the desired light mode. The default mode is activated on power-on. The modes available are listed below. When selected, the relevant symbol will illuminate:

Default — Door opening and closing controls the internal lights.

24Hr — After closing the door, the light will remain on for 24 hours.

30Min — After closing the door, the light will remain on for 30 minutes.

1Min — After closing the door, the light will remain on for 1 minute

5.  Adjusting the LED light brightness.
In 24hr/30min/1min light mode, the brightness of opening the door is 100%, and the default brightness after closing the door is 50%.
Each time the  button is pressed, the brightness will alternate between 50%, 75% and 100%.
6.  Power button
Press and hold this button for 3 seconds to turn off the appliance. With a slight press again to turn it on.
7.  temperature setting (up button)
Press this button to increase the temperature by one degree increments. When the setting reaches the temperature upper limit value 50°F. The set temperature will not change again.
8.  temperature setting (down button)
Press this button to lower the temperature by one degree increments. When the setting reach the temperature lower limit value 34°F. The set temperature will not change again.
9. To switch between Celsius or Fahrenheit.
Press and hold  and  for 3 seconds to switch between °C and °F. The indicator light will illuminate on the desired temperature setting.

Temperature control range:34-50°F.

The temperature preset at the factory is 43°F.

The product have power off memory function.

➤ **Temperature Alarm**

If inner temperature is higher than 73°F, The “HI” is shown in display panel, and the buzzer alarm after one hour continuously. It informs that the inner temperature is too high, please check the reason.

If inner temperature is too low, the “LO” is shown in display panel, and the alarm sounded at the same time.

When the set temperature is $\geq 39^{\circ}\text{F}$, the low-temperature alarm triggers at 32°F .

When the set temperature is between 36°F and 39°F ($36^{\circ}\text{F} \leq T < 39^{\circ}\text{F}$), the low-temperature alarm triggers at -36°F .

No low-temperature alarm is activated when the set temperature is below 36°F .

➤ **Temperature Recollection Function**

In the event of a power interruption, beverage center can remember the previous temperature settings, and when the power is recovery, the cooler temperature will go back to the same setting temperature as power off.

➤ **Door Ajar Alarm Function**

If the door is not closed completely the alarm will sound after 1 minute. Please close the door completely to avoid the loss of cold energy.

NOTE

If the unit is unplugged, power lost, or turned off, you must wait 3 to 5 minutes before restarting the unit. If you attempt to restart before this time delay, the beverage center will not start.

When you use the beverage center for the first time or restart the beverage center after having been shut off for a long time, there could be a few degrees variance between the temperature you select, and the one indicated on the LED readout. This is normal and it is due to the length of the activation time. Once the beverage center is running for a few hours everything will be back to normal.

WINE CHART

The maximum number of bottles that can be loaded into the cabinet are for information only. This information is not contractual as it provides a means for rapidly estimating the size of the device.

Loading proposal#1

Total: 116 bottles (Beverage Cans 109 + Bordeaux / Burgundy / Champagne 7 bottles)

Bottle loading proposal#1

Shelf: Wood Shelf(1)+Glass Shelf (2)

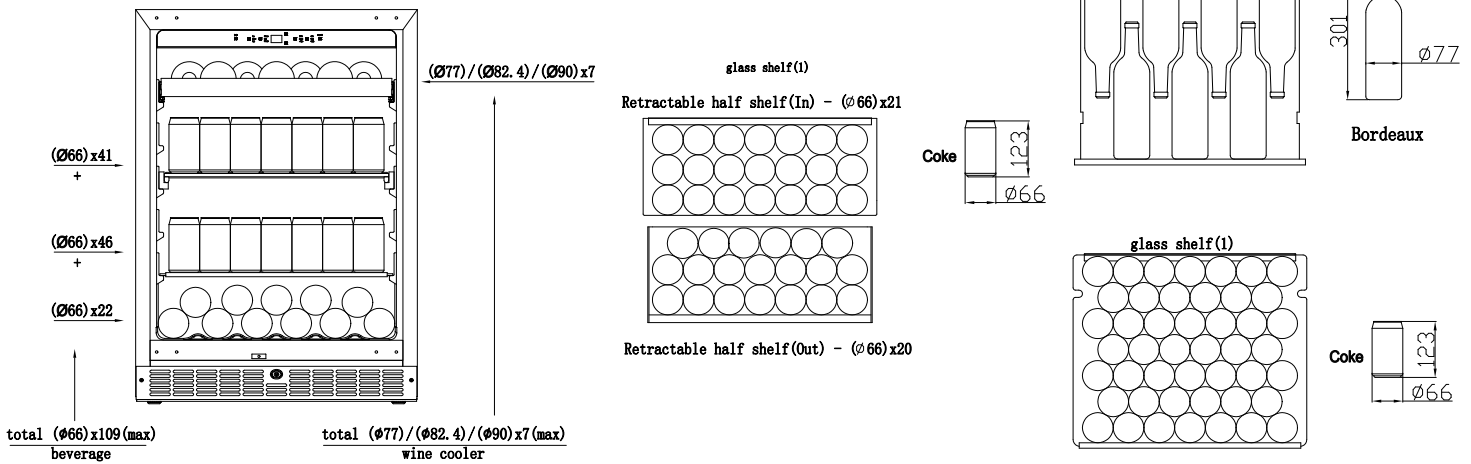

Loading proposal#2

Total: 96 bottles (Beverage Cans 89 + Bordeaux / Burgundy / Champagne 7 bottles)

Bottle loading proposal#2

The shelf design is the same as proposal#1

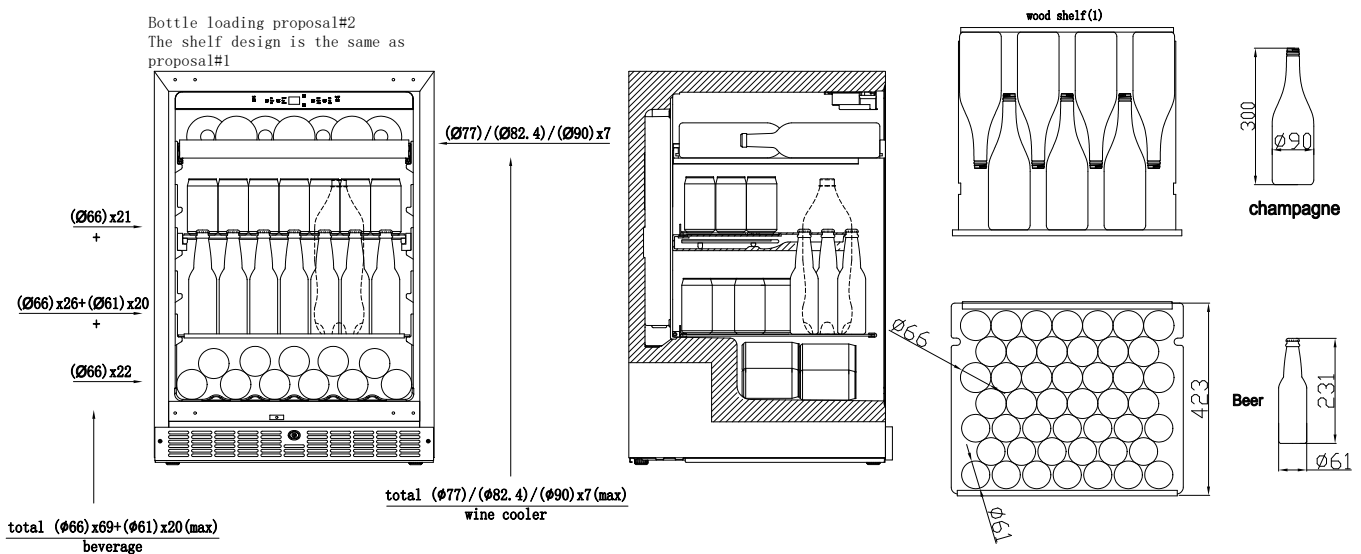

Loading proposal#3

Total:101 bottles (Beverage Cans 87 Cans +Bordeaux 14+ Burgundy / Champagne 7 bottles)

Bottle loading proposal#1
Shelf: Wood Shelf(1)+Glass Shelf (2)

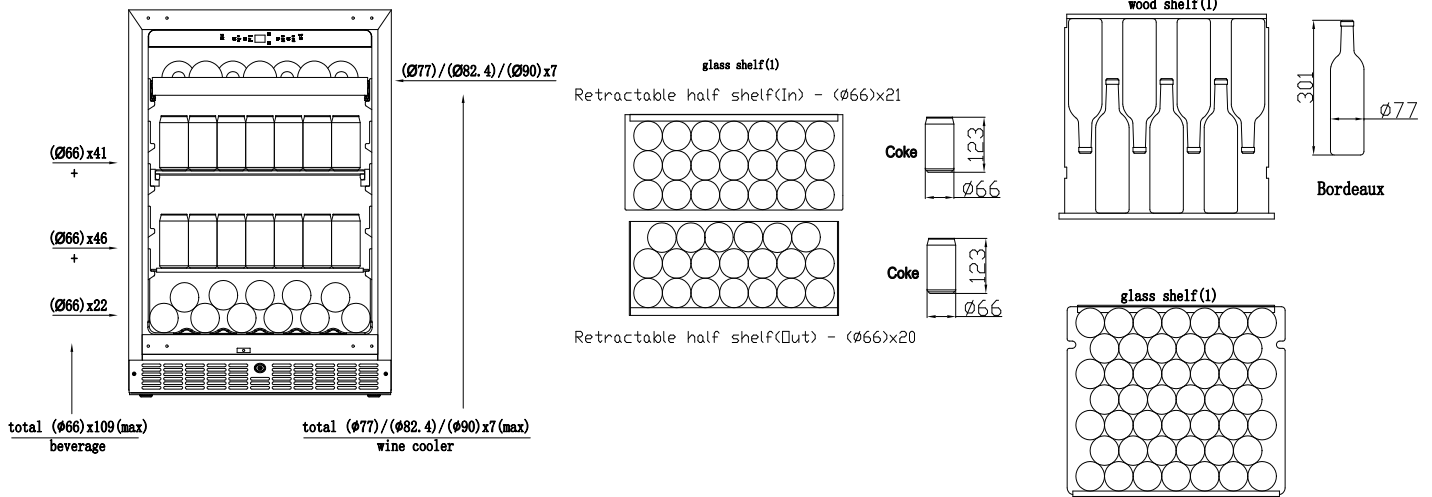

Loading proposal#4

Total:80 bottles (Beverage Cans 67 +Bordeaux / Champagne 7 bottles+Burgundy 13 bottles)

Bottle loading proposal#2
The shelf design is the same as proposal#1

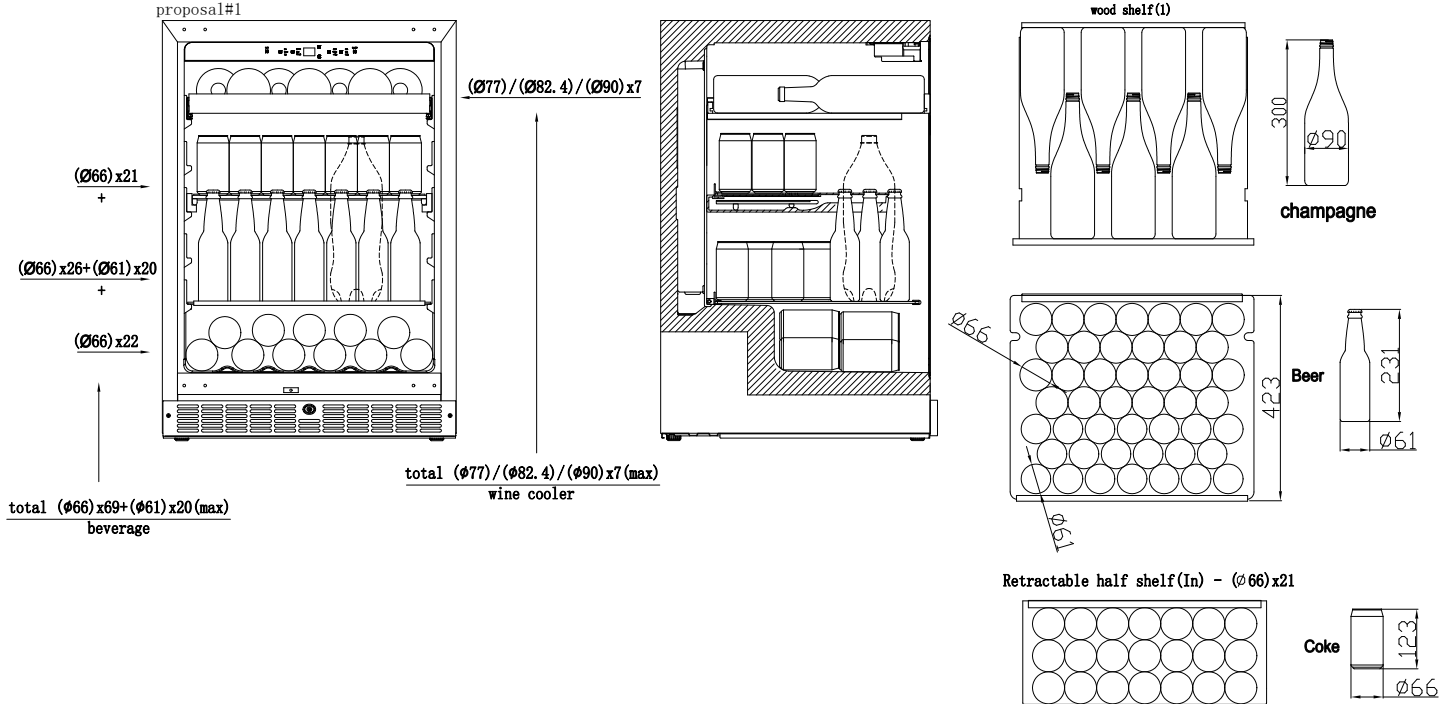

ADJUSTABLE SHELVES

- To prevent damaging the door gasket, make sure to have the door fully opened when pulling shelves out of the rail compartment.
- When removing any of these shelves out of the rail compartment, move the shelf towards the gap on both sides and alignment with shelf support.
- Then tilt the shelf upwards and pull it out from the cabinet once the shelf support is disengaged from the gap.

Note: Do not cover shelves with aluminum foil or any other material that will prevent air circulation within the appliance as this can adversely affect the internal temperature.

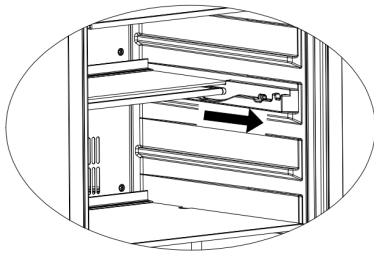
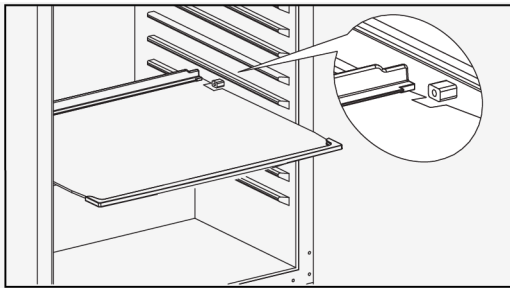

Before

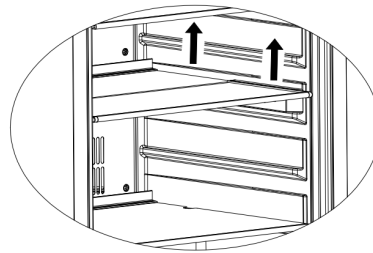

After

- To prevent damaging the door gasket, make sure to have the door fully opened when pulling shelves out of the rail compartment.
- For easy access to the storage content, you can pull the shelves approximately 1/3 out of the rail compartment.
- Do not cover the gaps on the racks with aluminum foil or any other material that will prevent adequate air circulation within the cabinet.
- According to the actual configuration of your product, please check the relative Remove or Replace Racks.

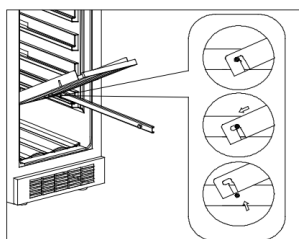
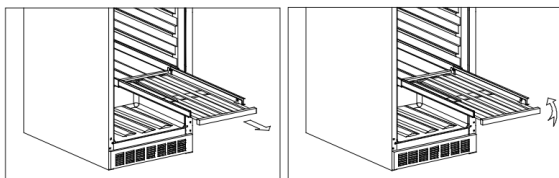

1. Fully extend the shelf you wish to remove.
2. Lift the front of the shelf up.
3. Holding the shelf track, push the shelf in, then up to release from the rear dampers.

REVERSIBILITY OF THE DOOR

Warning: To avoid accidents during the process of changing the door, we recommend that you get assistance.

The glass door is heavy and may cause injury if dropped.

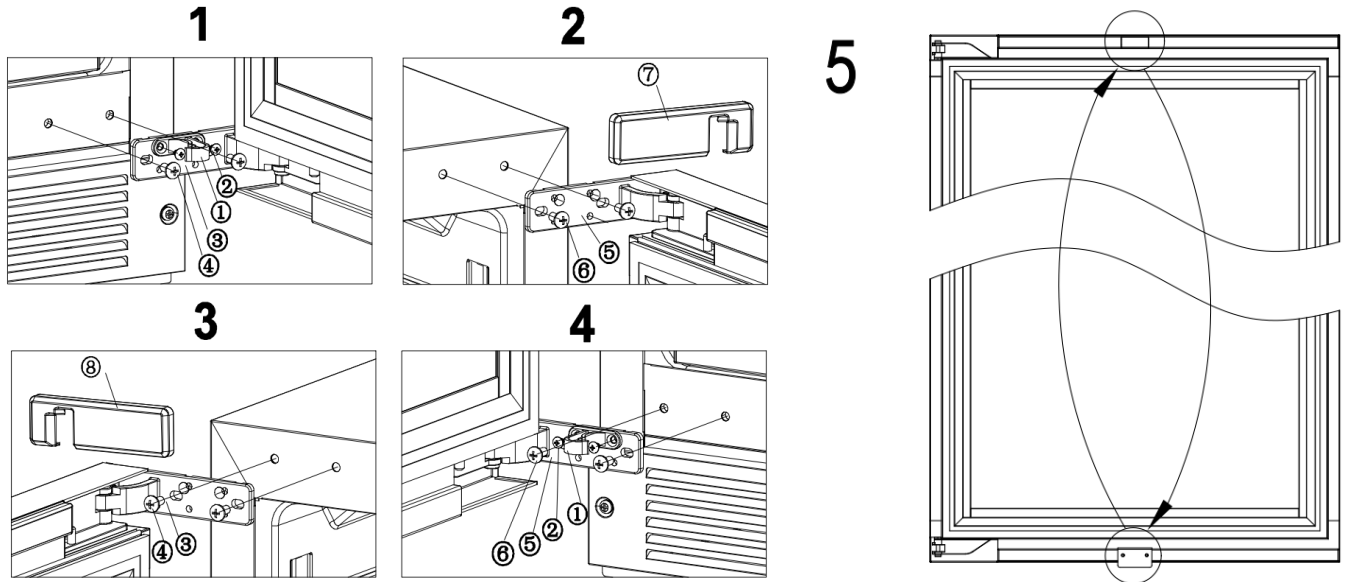

1. DOOR HINGER BUFFER
3. HINGE
5. HINGE
7. HINGE COVER

2. DOOR HINGE BUFFER SCREW
4. HINGE SCREW
6. HINGE SCREW
8. HINGE COVER

1. Remove the door hinge buffer screw first, and then remove the door hinge buffer (Standby) (Fig1)
2. Then remove the door hinge cover and right upper and lower hinge (Fig1.2)
3. Rotate the door 180 degrees, install the hinge screw, take the lower hinge cover from the kit and install it (Fig 3);
4. The install the door hinge buffer (Fig 4)
5. Remove the door light switch spacer from the lower door frame and the decorative cover from the upper door frame, then swap the positions of these two components 180° for reinstalation (Fig 5)

Standard-Depth Beverage Center

Standard-depth beverage center typically measure 25 to 29 inches in depth, as opposed to counter-depth beverage center that sit flush with cabinetry.

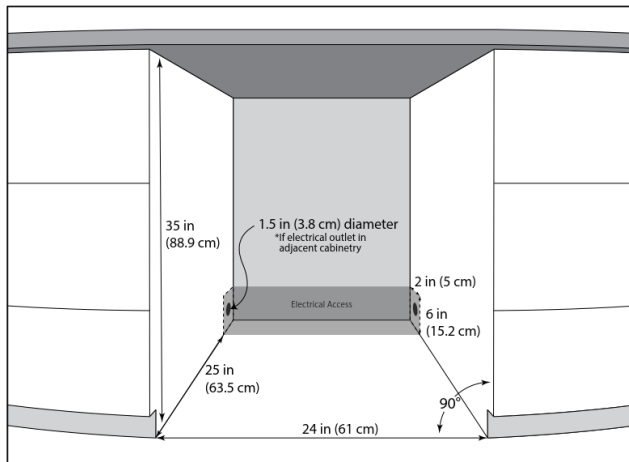

Installation clearances

- √ Ensure adequate ventilation around the beverage center. Do not block ventilation openings. Install in a well-ventilated area away from ignition sources. Proper airflow is required to prevent overheating and to reduce the risk of fire in appliances using flammable refrigerant (R600a).
- √ The cabinet opening must be at least 24 inches (61 cm) wide by 35 inches (88.9 cm) high by 25 inches (63.5 cm) deep.
- √ If the electrical outlet is located inside adjacent cabinetry, cut a 1.5 inch (3.8 cm) diameter hole to admit the power cord. If the cabinet wall is metal, the hole edge must be covered with a bushing or grommet.

For optimal usage and ability to open refrigerator doors completely, do not install next to a wall.

Please note: The above dimensions and cutout information is for planning purposes only.

Walk the delivery route

- √ Identify the narrowest opening that the appliance will travel through, from outside the home to the location where it will be installed.
- √ Appliance depth or width must be smaller than the width of the narrowest opening.

➤ Recommended DRINKING temperature

The following (approximate) temperatures are recommended for wine drinking:

○ For storing ALL TYPES OF WINES	54 – 57°F
○ Champagne NV, Sparkling	43°F
○ Champagne Vintage	50°F
○ Dry White Semillon, Sauvignon Blanc	46°F
○ Dry White Gewürztraminer, Riesling	50°F
○ Dry White Chardonnay	50°F
○ Vintage Chardonnay	57°F
○ Sweet White Sauternes Monbazillac, Late Harvest ice wine	50°F
○ Sweet whites vintage Sauternes	57°F
○ Beaujolais	55°F
○ Red Pinot Noir	61°F
○ Vintage Pinot Noir red	64°F
○ Red Grenache, Syrah	61°F
○ Red Cabernet, Merlot, French, Australian, New Zealand, Chilean, Argentinean, Italian, Spanish, Californian	64°F

REQUIRED TOOLS

- Safety goggles
- Gloves
- Tape measure
- Carpenter square
- Level
- Flashlight
- Electric drill with hole bit

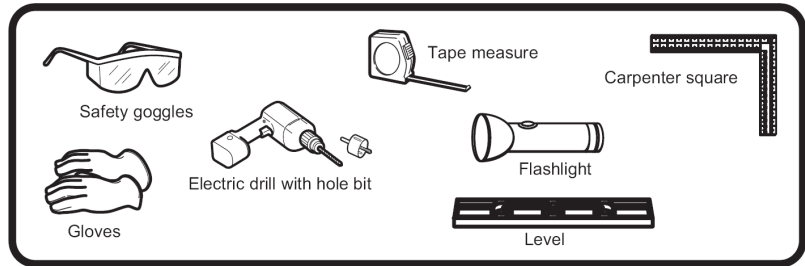

INSTALLING THE ANTI-TIP BRACKET FOR FREE STANDING

WARNING:

This appliance may tip when shelves are extended, causing damage or injury. If this appliance is used in a free standing application, the anti-tip bracket must be installed following these instructions!

Anti-tip bracket parts list:

- A: Anti-tip bracket (1pc)
 - B: Hexagon bolt (1pc) size (6mm x 20mm) (1/4"x4/5")
 - C: Lock washer (1pc) size (6)
 - D: Flat washer (1pc) size (6)
 - E: Screw (2pcs) size (ST4x35)
 - F: Expansion screw (1 pc) size (6mmX60mm) (1/4"x2.4")
- Secure the bracket with the screws provided.

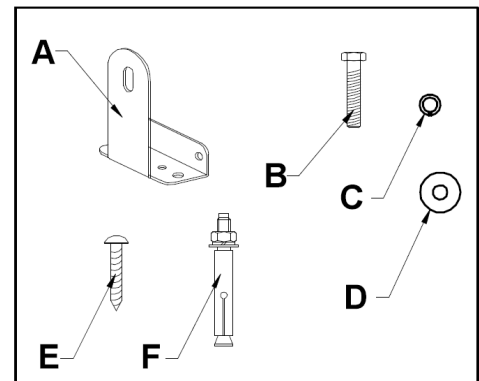

Anti-tip bracket installation

The bracket can be installed at the left bottom OR right bottom of the back of the unit. You can choose which side is convenient for you.

Anti-tip bracket mounting hole instruction:

- Location a: Fixed mounting hole for unit
- Location b: Fixed mounting holes for Drywall
- Location c: Fixed mounting holes for Wood floor
- Location d: Fixed mounting holes for Concrete floor
- Location e: Mounting hole on the back unit

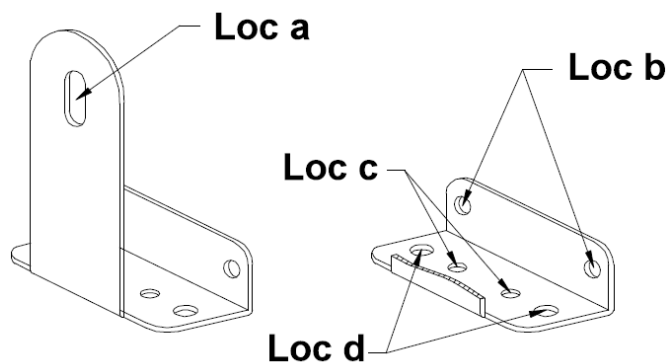
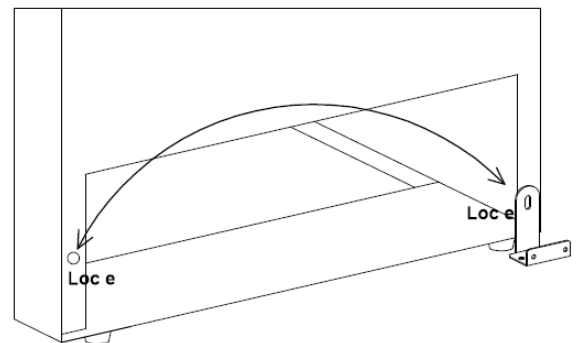

IMPORTANT:

Determine the final location of the appliance before attempting to install the bracket. You will need to choose one of the three installation methods below.

DRYWALL installation:

1. After you have chosen the installation location, place the bracket on the floor with Loc b against the wall, use Screw (E) (2pcs) to secure the bracket to the wall. Ensure at least one screw is secured into a stud.

2. Move the unit to align Loc e to bracket Loc a, secure with the bolt (B), lock washer (C) and flat washer (D).

NOTE: The screws MUST enter into a wood stud. If the wall contains metal studs or similar materials, then the floor installation must be used

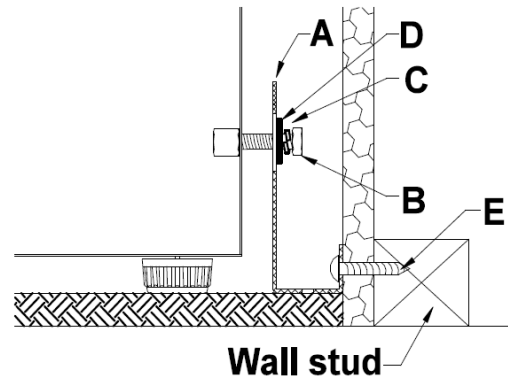

WOOD FLOOR installation:

1. After you have chosen the installation location, place the bracket on the wood floor, use: Screw (E) (2pcs) align Loc C and secure the bracket into wood floor.

2. Move the unit to align Loc e to bracket Loc a, secure with the bolt (B), lock washer (C) and flat washer (D).

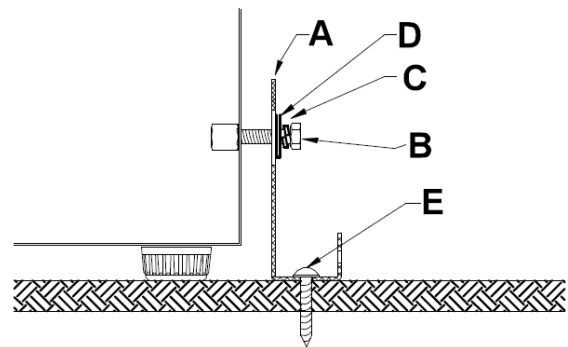

CONCRETE FLOOR installation:

1. After you have chosen the installation location, choose any hole of Loc d to secure the bracket into the concrete floor.
2. Using a concrete bit, drill 8mm (3/8") pilot hole 45~55mm (1.7"~2") deep.
3. Remove the nut, spring washer and washer of the expansion screw.
4. Carefully tap the expansion screw into the concrete, using a hammer or mallet.
5. Align Loc d and secure the nut, spring washer, washer tightly back on the expansion screw and fix on the concrete floor.
6. Move the unit to align Loc e to bracket Loc a, secure with the bolt (B), lock washer (C) and flat washer (D).

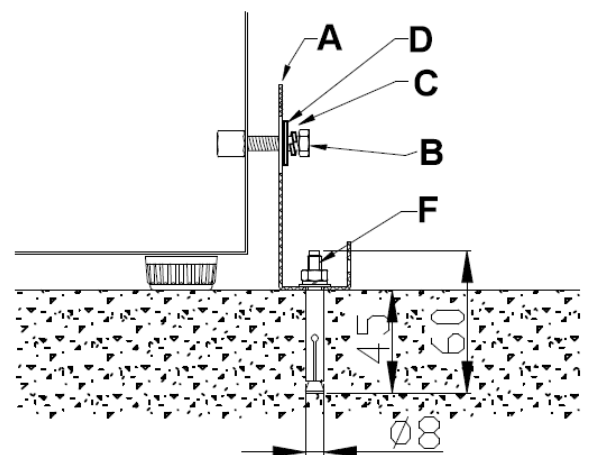

ATTENTI ON:

Check the bracket: After installing the bracket, try using light force to tip the unit. If the unit does not tip then the bracket mounted securely. If the unit does tip, the bracket MUST be reinstalled following these instructions.

CARE AND MAINTENANCE

➤ **Cleaning Your Beverage Center**

- Turn off the power, unplug the appliance, and remove all items including shelves and rack.
- Wash the inside surfaces with warm water and baking soda solution. The solution should be about 2 tablespoons of baking soda to a quart of water.
- Wash the shelves with a mild detergent solution.
- Wring excess water out of the sponge or cloth when cleaning area of the controls, or any electrical parts.
- Wash the outside cooler with warm water and mild liquid detergent. Rinse well and wipe dry with a clean, soft cloth.

➤ **Power Failure**

- Most power failures are corrected within a few hours and should not affect the temperature of your appliance if you minimize the number of times the door is opened. If the power is going to be off for a longer period of time, you need to take the proper steps to protect your contents.

➤ **Vacation Time**

- Short vacations: Leave the beverage center operating during vacations of less than three weeks.
- Long vacations: If the appliance will not be used for several months, remove all items and turn off the appliance. Clean and dry the interior thoroughly. To prevent odor and mold growth, leave the door open slightly, blocking it open if necessary.

➤ **Moving Your Beverage Center**

- Remove all items.
- Securely tape down all loose items (shelves) inside your appliance.
- Turn the adjustable leg up to the base to avoid damage.
- Tape the door shut.
- Be sure the appliance stays secure in the upright position during transportation. Also protect outside of appliance with a blanket, or similar item.

➤ **Energy Saving Tips**

- The beverage center should be located in the coolest area of the room, away from heat producing appliances, and out of the direct sunlight.

PROBLEMS WITH YOUR BEVERAGE CENTER?

You can solve many common beverage center problems easily, saving you the cost of a possible service call. Try the suggestions below to see if you can solve the problem before calling the service.

TROUBLESHOOTING GUIDE

PROBLEM	POSSIBLE CAUSE
Beverage center does not operate.	Not plugged in. The appliance is turned off. The circuit breaker tripped or a blown fuse.
Beverage center is not cold enough.	Check the temperature control setting. External environment may require a higher setting. The door is opened too often. The door is not closed completely. The door gasket does not seal properly.
Turns on and off frequently.	The room temperature is hotter than normal. A large amount of contents has been added to the beverage center. The door is opened too often. The door is not closed completely. The temperature control is not set correctly. The door gasket does not seal properly.
The light does not work.	Not plugged in. The circuit breaker tripped or a blown fuse. The bulb has burned out. The light button is "OFF".
Vibrations.	Check to assure that the beverage center is level.
The beverage center seems to make too much noise.	The rattling noise may come from the flow of the refrigerant, which is normal. As each cycle ends, you may hear gurgling sounds caused by the flow of refrigerant in your beverage center. Contraction and expansion of the inside walls may cause popping and crackling noises. The beverage center is not level.

<p>The door will not close properly.</p>	<p>The beverage center is not level.</p> <p>The door was reversed and not properly installed.</p> <p>The gasket is dirty.</p> <p>The shelves are out of position.</p>
--	---

Before disposal of the appliance.

Before disposal, disconnect the beverage center from the power supply. This appliance contains a flammable refrigerant (R600a). The refrigerant must be recovered by authorized personnel in accordance with local regulations. Remove the door to prevent child entrapment.

Correct disposal of this product	
	<p>This symbol on the product, or in its packaging, indicates that this product may not be treated as household waste. Instead, it should be taken to the appropriate waste collection point for the recycling of electrical and electronic equipment. By ensuring this product is disposed of correctly, you will help prevent potential negative consequences for the environment and human health, which could otherwise be caused by the inappropriate waste handling of this product. For more detailed information about the recycling of this product, please contact your local council, your household waste disposal service, or the shop where you purchased the product.</p>

Element Appliance Limited Warranty

(the “Products” or “Product” when referencing a singular product herein)

This Product (including any accessories included in the original packaging) as supplied and distributed in new condition, is warranted by Element Appliance Company, LLC (“Element”) to the original customer who purchases the Product from an authorized Element retailer (the “Original Customer” or “you”) against defects in material and workmanship under proper use, maintenance, and care according to the owner’s manual, warnings, and instructions accompanying the Product (“Warranty”) as follows:

* **PLEASE NOTE** – Proof of purchase evidencing the date of purchase by the Original Purchaser from an authorized Element retailer (“Valid Proof of Purchase”) is **required** for all Warranty service. The express Warranty set forth herein is subject to all terms and conditions set forth below.

1.WARRANTY SERVICE:

A.ONE-YEAR WARRANTY: Except as provided in subpart 1.B below, for a period of **one (1) year** from the date of purchase by the Original Customer (the “Warranty Period”), if the parts or components covered by this Warranty are determined by Element or Element’s authorized service provider to be defective in material or workmanship, Element will, at its sole and absolute discretion and option: (i) repair the defective part or component at no charge to the Original Customer, (ii) replace the defective Product with a new Product of similar or better quality, at no charge to the Original Customer, or (iii) refund the documented purchase price paid by the Original Customer (excluding tax) to the Original Customer upon return of the defective Product as directed by Element. After the Warranty Period expires, the Original Customer must pay for all parts, components, shipping and handling, labor, and replacement costs associated with the Product or any part or component thereof, regardless of any defects in the Product or any part or component thereof.

B.LIMITED EXTENDED WARRANTY THROUGH PRODUCT REGISTRATION:

If and only if the Original Customer registers the Product at www.elementelectronics.com within **ninety (90)** days of the date of purchase by the Original Customer, then the Warranty Period discussed in subpart 1.A. above shall be extended an additional one (1) year to a new Warranty Period equaling **two (2) years** from the date of purchase by the Original Customer. If the Product is not registered as provided for in this subpart 1.B, then the standard one-year Warranty Period set forth in subpart 1.A shall apply.

C.TIMING AND PROCEDURE: Before Warranty service can commence, the Original Customer must contact either (i) the retailer from whom the Original Customer purchased the Product, or (ii) Element directly, in either case for problem determination and service procedures. Valid Proof of Purchase evidencing that the Product is within the Warranty Period **MUST** be presented by Original Customer in order to obtain the requested Warranty service. Please have your model and serial number available, along with your date of purchase of the Product. To remain eligible for Warranty service, Original Customer may not return the Product or any part or component thereof to the retailer or Element without Element’s prior written consent.

2.EXCLUSIONS AND LIMITATIONS TO WARRANTY SERVICE

The Warranty covers manufacturing defects in materials and workmanship of the Product encountered in the normal, non-commercial use of the Product, and **does not cover** (a) damages or malfunctions resulting from improper or unreasonable

use or maintenance, abuse, negligence, failure to follow instructions contained in any written materials that accompany the Product, deterioration by reason of excess moisture, corrosive atmosphere, lightning, power surges, connections to improper voltage supply, unauthorized alteration, or other external causes such as extremes in temperature or humidity, modifications, scratches or discoloration; (b) any damage caused by using non-authorized parts or service facilities for repair of Products (however, for avoidance of doubt, using non-authorized parts or service facilities will not, in and of itself, void the Warranty); (c) transportation, shipping, delivery, pickup, insurance, installation, or set-up costs; (d) ordinary wear and tear, cosmetic damage, or damage due to acts of nature, including but not limited to, water, floods, wind, storm, tornado, earthquake, or fire, or due to damage caused by extraordinary impact events, such as dropping, crushing, demolition or other extraordinary damage; (e) commercial use of the Product, or use of the Product for anything other than single-family household or residential use; or (f) modification of the Product or any part of the Product.

This Warranty is made to the Original Customer only and does not cover Products sold AS IS or WITH ALL FAULTS. The Warranty is invalid if the factory-applied serial number has been altered or removed from the Product. This Warranty is valid only in the United States, and only applies to Product if it was purchased and serviced in the United States. The addition of equipment or features to the Product that are not manufactured or recommended by Element could affect the intended function of the Product, and therefore may void the Warranty. Furthermore, the exposure of the Product to chemicals, heat, cold, humidity, or other elements can affect the Product components, and therefore, the Warranty does not cover discoloration, fading, cosmetic changes, rust, or any damages or failure related to any such items. The Warranty is contingent upon the proper use, maintenance, and care of the Product. The Warranty may be void if the Product has been used in a manner contradictory to, or in violation of, the terms of the user's manual, warnings, or instructions accompanying the Product.

THIS WARRANTY IS MADE IN LIEU OF AND SUPERSEDES ALL OTHER WARRANTIES OR CONDITIONS OF MERCHANTABILITY OR FITNESS FOR A PARTICULAR PURPOSE OR GENERAL USE, WHETHER EXPRESS, IMPLIED, COLLATERAL, STATUTORY, OR PROVIDED BY COMMON LAW, THE UNIFORM COMMERCIAL CODE, OR OTHERWISE. ELEMENT FURTHER DISCLAIMS ALL WARRANTIES AFTER THE END OF THE WARRANTY TERM DEFINED ABOVE. NO OTHER EXPRESS WARRANTY OR GUARANTY GIVEN BY ANY OTHER PERSON, FIRM, OR ENTITY WITH RESPECT TO THE PRODUCT SHALL BE BINDING ON ELEMENT. REPAIR, REPLACEMENT, OR REFUND OF THE ORIGINAL PURCHASE PRICE, AT ELEMENT'S SOLE DISCRETION, ARE THE EXCLUSIVE REMEDIES OF THE CUSTOMER.

ELEMENT SHALL NOT BE LIABLE FOR ANY INCIDENTAL OR CONSEQUENTIAL DAMAGES CAUSED BY THE USE, MISUSE, OR INABILITY TO USE THE PRODUCT. THESE INCLUDE, BUT ARE NOT LIMITED TO, ANY DAMAGES IN THE FORM OF LOST PROFITS, LOSS OF USE, LEGAL FEES, ECONOMIC LOSS, PERSONAL INJURIES, OR ANY OTHER DAMAGES CAUSED BY CIRCUMSTANCES BEYOND THE CONTROL OF ELEMENT. NOTWITHSTANDING THE FOREGOING, ELEMENT'S AGGREGATE LIABILITY TO ANY CUSTOMER SHALL NOT EXCEED THE ORIGINAL PURCHASE PRICE OF THE PRODUCT. THIS WARRANTY SHALL NOT EXTEND TO ANYONE OTHER THAN THE ORIGINAL CUSTOMER WHO PURCHASED THE PRODUCT, AND IS NOT TRANSFERRABLE. NO PERSON IS AUTHORIZED TO ALTER, EXTEND, OR WAIVE THIS WARRANTY OR ANY OF ITS TERMS OR CONDITIONS.

Some states do not allow the exclusion or limitation of incidental or consequential damages, or allow limitations on warranties, so the above limitations or exclusions may not apply to you. This Warranty gives you specific rights, and you may have

other rights, which vary from state to state. The exclusions and limitations to the Warranty apply to the maximum extent permitted by law and unless restricted or prohibited by law. Where any term of this Warranty is prohibited by applicable law, it shall be null and void, but the remainder of this Warranty shall remain in effect.

PLEASE DIRECT ALL CORRESPONDENCE TO:

Element Appliance Company, LLC
customerservice@elementelectronics.com
(888) 842-3577
<https://elementelectronics.com>

Element, the Element Logo, and Bring it home are trademarks of Element Brand Holding, LLC. All other trademarks are the property of their respective owner, who has not sponsored, endorsed, or approved this product. ©2025 Element Appliance Company, LLC. All rights reserved.

**Distributed by Element Appliance Company, LLC
Augusta, GA 30909**

**For service, support and warranty information:
Call 888.842.3577, email us at customerservice@elementelectronics.com or visit
www.elementelectronics.com**