

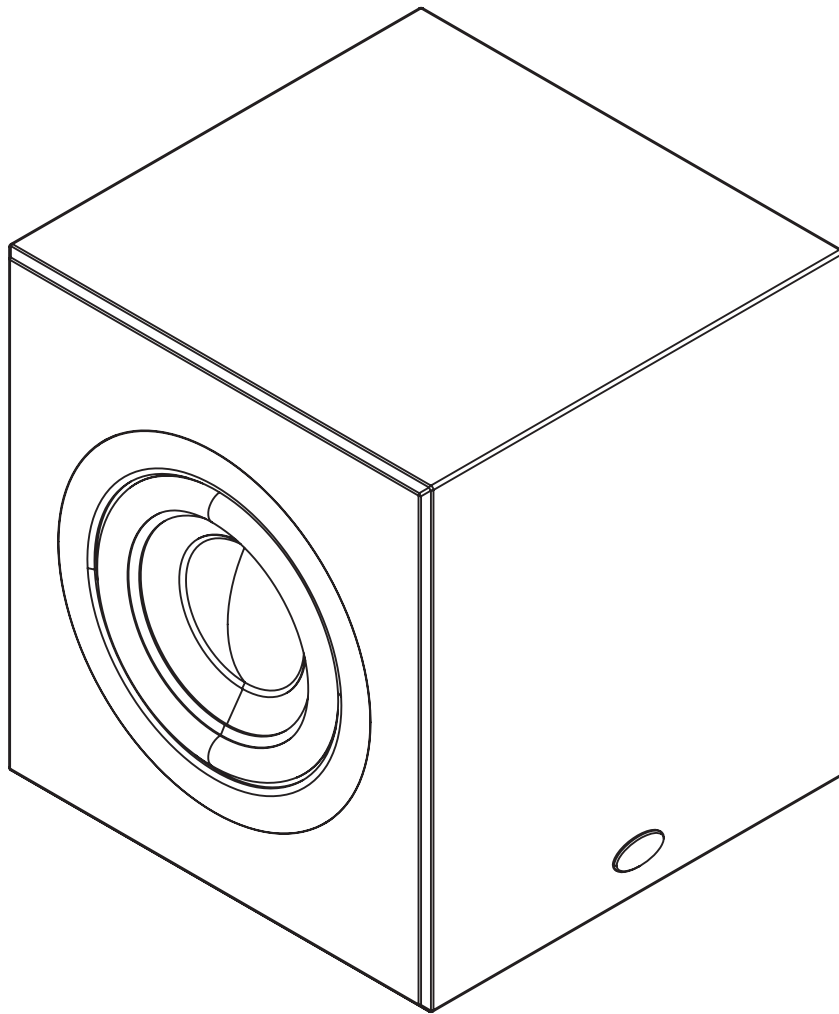

SubSeries BP12

OWNER'S GUIDE



IMPORTANT SAFETY INSTRUCTIONS

1. Read these instructions.
2. Keep these instructions.
3. Heed all warnings.
4. Follow all instructions.
5. Do not use this apparatus near water.
6. Clean only with dry cloth.
7. Do not block any ventilation openings. Install in accordance with the manufacturer's instructions.
8. Do not install near any heat sources such as radiators, heat registers, stoves, or other apparatus (including amplifiers) that produce heat.
9. Do not defeat the safety purpose of the polarized or grounding-type plug. A polarized plug has two blades with one wider than the other. A grounding type plug has two blades and a third grounding prong. The wide blade or the third prong are provided for your safety. If the provided plug does not fit into your outlet, consult an electrician for replacement of the obsolete outlet.
10. Protect the power cord from being walked on or pinched particularly at plugs, convenience receptacles, and the point where they exit from the apparatus.
11. Only use attachments/accessories specified by the manufacturer.
12. Use only with the cart, stand, tripod, bracket, or table specified by the manufacturer, or sold with the apparatus. When a cart is used, use caution when moving the cart/apparatus combination to avoid injury from tip-over. 
13. Unplug this apparatus during lightning storms or when unused for long periods of time.
14. Refer all servicing to qualified service personnel. Servicing is required when the apparatus has been damaged in any way, such as power-supply cord or plug is damaged, liquid has been spilled or objects have fallen into the apparatus, the apparatus has been exposed to rain or moisture, does not operate normally, or has been dropped.
15. The apparatus shall not be exposed to dripping or splashing and that no objects filled with liquids, such as vases, shall be placed on the apparatus.
16. **WARNING:** To reduce the risk of fire or electric shock, this apparatus should not be exposed to rain or moisture.
17. The mains plug or an appliance coupler is used as the disconnect device, the disconnect device shall remain readily operable.



The lightning flash with arrowhead symbol within an equilateral triangle, is intended to alert you to the presence of uninsulated "dangerous voltage" within the product's enclosure that may be of sufficient magnitude to constitute a risk of electric shock to persons.



The exclamation point within an equilateral triangle is intended to alert you to the presence of important operating and maintenance (servicing) instructions in the literature accompanying the product.

FCC WARNINGS

This device complies with part 15 of the FCC Rules. Operation is subject to the following two conditions: (1) This device may not cause harmful interference, and (2) this device must accept any interference received, including interference that may cause undesired operation.

Any changes or modifications not expressly approved by the party responsible for compliance could void the user's authority to operate the equipment.

FCC STATEMENT

This equipment has been tested and found to comply with the limits for a Class B digital device, pursuant to part 15 of the FCC Rules. These limits are designed to provide reasonable protection against harmful interference in a residential installation. This equipment generates uses and can radiate radio frequency energy and, if not installed and used in accordance with the instructions, may cause harmful interference to radio communications. However, there is no guarantee that interference will not occur in a particular installation. If this equipment does cause harmful interference to radio or television reception, which can be determined by turning the equipment off and on, the user is encouraged to try to correct the interference by one or more of the following measures:

- Reorient or relocate the receiving antenna.
- Increase the separation between the equipment and receiver.
- Connect the equipment into an outlet on a circuit different from that to which the receiver is connected.
- Consult the dealer or an experienced radio/TV technician for help.

This equipment complies with FCC radiation exposure limits set forth for an uncontrolled environment. This equipment should be installed and operated with minimum distance 20cm between the radiator & your body.

IC WARNING

This radio transmitter has been approved by Industry Canada.

This Class B digital apparatus complies with Canadian standard ICES-003. This device complies with Industry Canada License exempt RSS standard(s). Operation is subject to the following two conditions.

- (1) This device may not cause interference and
- (2) this device must accept any interference, including interference that may cause undesired operation of the device.

This equipment complies with ISED radiation exposure limits set forth for an uncontrolled environment. This equipment should be installed and operated with minimum distance 20cm between the radiator & your body.

NOTES ON ENVIRONMENTAL PROTECTION



At the end of its useful life, this product must not be disposed of with regular household waste but must be returned to a collection point for the recycling of electrical and electronic equipment. The symbol on the product, user's manual and packaging, point this out.

The materials can be reused in accordance with their markings. Through re-use, recycling of raw materials, or other forms of recycling of old products, you are making an important contribution to the protection of our environment.

Your local administrative office can advise you of the responsible waste disposal point.

Introduction

PSB subwoofers are designed to provide the flattest possible frequency response, full bass extension, low distortion and high output. Beyond these characteristics there are a few other parameters that we feel are very important in the design of a subwoofer. First and foremost, a PSB subwoofer must be musical. A subwoofer should also have the ability to play musically even when overloaded or stressed. For this reason PSB subwoofers incorporate limiting circuitry preventing audible overload while remaining true to the dynamics of the music. This circuitry combines peak limiting circuits that hold amplifier signal swing to the point just short of the amplifier's clipping, with compression circuitry that will reduce the amplifier's gain.

Managing heat dissipation is challenging with today's greater power demands. Where suitable, PSB subwoofers use the latest implementation of direct digital power amplification, that maintains maximum efficiency and low THD under all conditions.

PSB woofers are always designed to reduce mechanical noise and prevent harsh sounds at the excursion extremes. Cabinets and amplifiers are designed to prevent air leaks, which can contribute minute amounts of noise. All of our designs are exhaustively tested to survive 15 continuous hours of being driven to maximum output.

We hope that our attention to detail results in countless hours of pleasant entertainment. Please take the time to read the following sections about the placement of your subwoofer, its connections and adjustments. Enjoy.

Contents

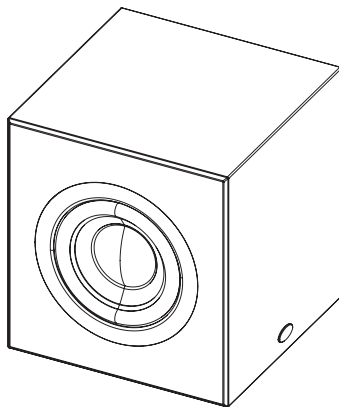

Quick Start Instructions

1

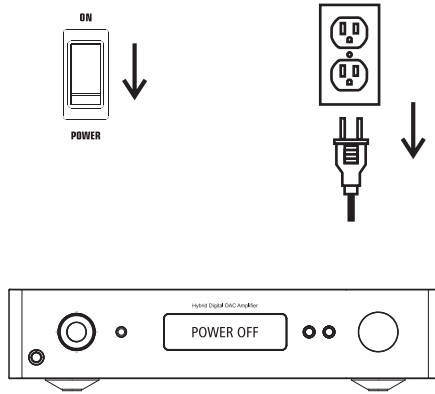

2

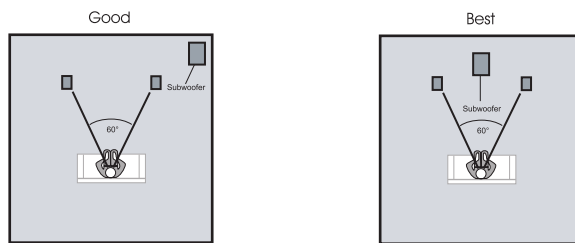

3

SUBWOOFER/LFE INPUT

Unbalanced

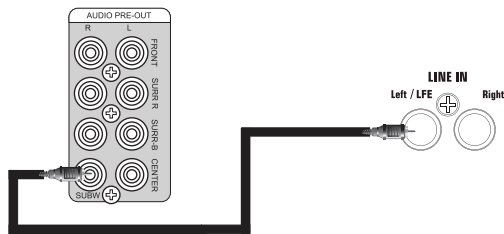

Balanced



If using a **subwoofer/LFE connection**, use the Bass Management Controls in the Receiver or Processor. It will not be necessary to connect the subwoofer to the BP12 APP.

4

LINE INPUT

Unbalanced

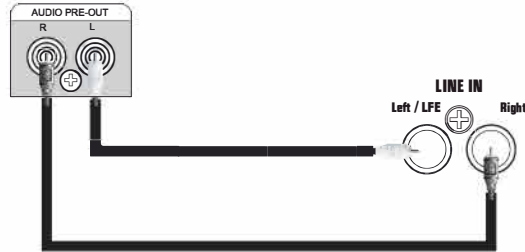

Balanced

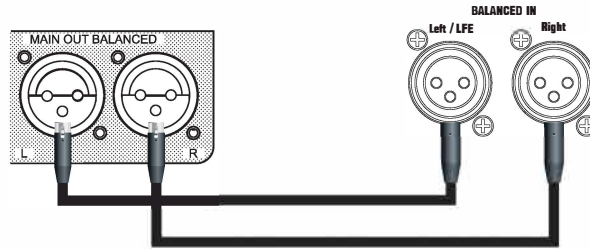

5

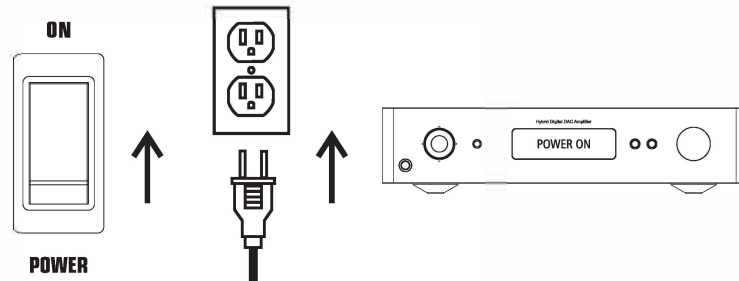
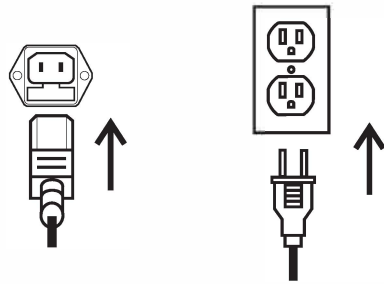
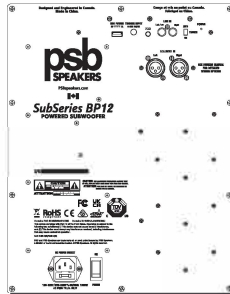

If using a **subwoofer/LFE connection**, use the Bass Management Controls in the Receiver or Processor. It will not be necessary to connect the subwoofer to the BP12 APP.

Connections and Controls

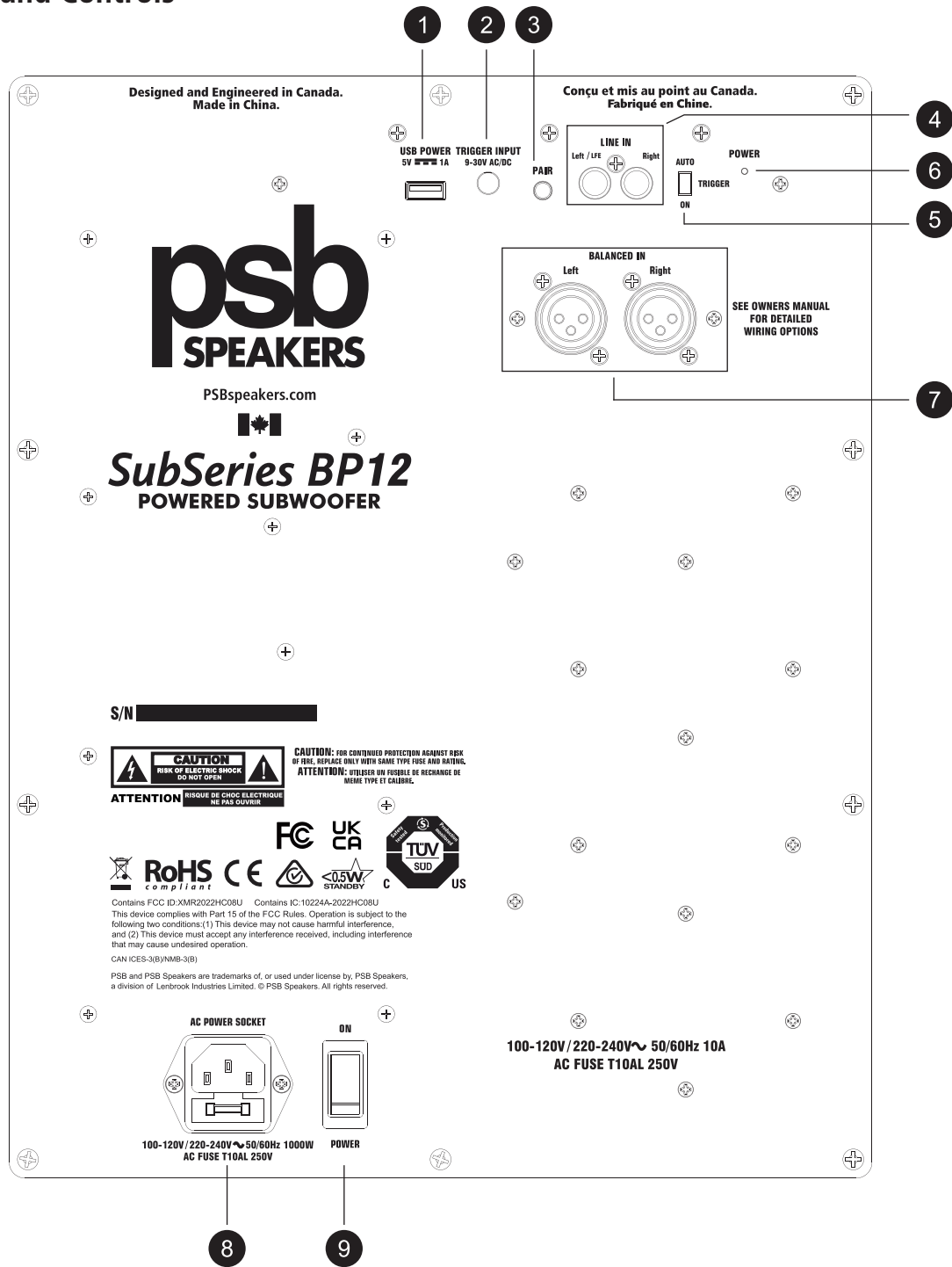

1 USB POWER

To provide power for a wireless subwoofer receiver (not included).

2 TRIGGER INPUT

Triggers the activation or deactivation of the subwoofer by connecting a 12V signal from an electronic component.

3 PAIRING BUTTON

Press to initiate Bluetooth pairing with mobile phone.

4 UNBALANCED/ RCA AUDIO INPUT

Use to connect line level full range left and right output from external preamplifier, integrated amplifier or receiver.

OR

LFE / Subwoofer Input

Connect LFE/Subwoofer output from external preamplifier, integrated amplifier or receiver.

5 SUBWOOFER ACTIVATION SWITCH

Three-way switch setting for activating the subwoofer.

Auto: Subwoofer is activated when an audio signal is detected.

Trigger: Subwoofer is activated when there is 12V Trigger input.

On: Subwoofer is always active.

6 SUBWOOFER STATUS LIGHT

Three color LED power indicator.

Red: Standby mode

Green: Active mode

Blue/Red: Paring

Notes:

- Subwoofer will stay active for approximately 15 minutes with no audio signal. Longer active times can be chosen in the mobile app.
- Verify the electrical integrity of the fuse located within the back panel's AC Power Socket if the subwoofer is powered on but displays no LED light or any sound.

7 BALANCED/ XLR AUDIO INPUT

Use to connect line level full range left and right output from external preamplifier, integrated amplifier or receiver.

OR

LFE / Subwoofer Input

Connect LFE/Subwoofer output from external preamplifier, integrated amplifier or receiver.

8 AC POWER SOCKET

Supplies AC power to the PSB subwoofer. Connect the supplied power cord to the AC Power socket. Plug the other end of the power cord into any standard wall outlet. Utilize the same receptacle as the rest of the system or another on the same electrical circuit to prevent ground hum.

A spare fuse is housed within the fuse holder compartment located behind the engraved text. Use a wide slot screwdriver to pry the fuse holder compartment from the AC power socket. If fuse replacement becomes necessary, utilize a fuse that matches the type and rating of the original fuse supplied with the product. Refer to the specifications page for a detailed description of the fuse required for your specific model of subwoofer.

9 POWER SWITCH

Switch ON/OFF the subwoofer's internal amplifier.

Room Acoustics

If you are critical about low-frequency response, there's quite a bit of useful experimentation you can do, especially in combination with the crossover, level, and phase controls of our subwoofers.

Begin by considering the size of the listening room. The larger the volume of air a speaker must move, the more acoustic output is required to achieve the sound levels you want. In smaller rooms, sound attenuation tends to be offset by reinforcement from wall reflections. In larger spaces, sound has to travel to reach the reflecting surfaces and then to your ears, which means it has to be louder to begin with. With traditional full-range speakers, that involves properly matching amplifier power, speaker sensitivity, impedance and power handling. Most of the power goes to reproducing bass, so using powered subwoofers and separate midrange/treble satellites allows for a conservative draw on power from your main amplifier, while ensuring a good match between the low-frequency amplifier and the woofer.

After size, the most important aspect of a listening room is its shape. In any room, sound reflects off the walls, ceiling, and floor. If the distance between two opposite parallel surfaces is a simple fraction of the wavelength of a particular frequency, notes of that frequency will bounce back and forth in perfect phase - an effect called a standing wave or room mode. At some point in the room, this note will be reinforced substantially; at others it will cancel out almost entirely. If the prime listening seat is placed at either of these locations, the note will be a horrible boom or virtually non-existent. Almost all rooms are susceptible to some standing waves at low frequencies, but careful positioning of the speakers and the listening seat can minimize the effects. The only way to find out what works best is by experimentation.

Speaker positioning may be fairly limited in your room to still get proper imaging, and some of these positions may still result in standing waves. Use of a subwoofer or two makes this more controllable. Positioning of the bass speakers has almost no impact on imaging, so a subwoofer can be positioned with only standing waves in mind.

Subwoofer Placement

The loudest bass output from a subwoofer comes from corner placement. The outward flaring of walls from a corner focuses low frequencies, giving them no place to go but toward the listener. In the case of subwoofers, there is no penalty in overall balance for this maximal bass since your main speakers can be located elsewhere. In most cases, there should be plenty of bass from corner placement.

If you are seated in a null spot where sound from the subwoofer is cancelled or diminished by out-of-phase reflections, you will have to move either the subwoofer or your listening position until you get the desired bass. Flipping the phase control 180 degrees sometimes may make a difference, especially if the null is a product of cancellations caused by interaction with low frequencies from your main speakers. If the opposite is happening, where direct and reflected bass waves converge in phase and produce too strong a peak at your listening position, you can change position or change your sub's level control (or possibly the crossover frequency chosen).

The best method for positioning a subwoofer is to put the subwoofer in your listening chair, then play music with lots of bass through the system (something with steady low frequencies or continuous test tones). Move around the room and note where the bass sounds best; if you place the subwoofer in that location, you should achieve the same bass performance. This test only works if you have your ears at the same height as where the subwoofer will be, so you may have to get down low. A recommended starting point for the placement of this subwoofer would be in either of the front corners of the room, on either side of the main speakers.

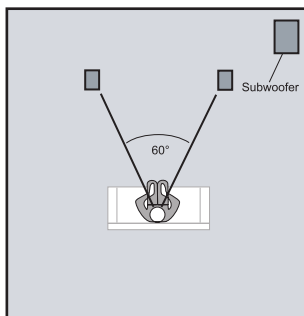

Most bass output;
least even bass response

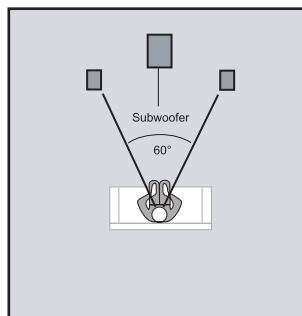

Moderate bass output;
more even bass response

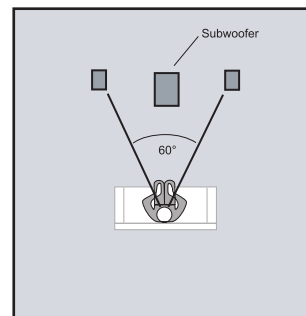

Lowest bass output;
most even bass response

Multiple Subwoofers - Why Two Subs Are Better Than One

Sometimes the listening room is not conducive to achieving satisfying amounts or the quality of bass. There are rooms with troublesome dimensions, especially those that are more cubical. In such a case, two subwoofers placed carefully to work with each other are recommended to handle acoustical anomalies. This can also be applied when the problem is too much, or too uneven, bass. The overall system benefits from each subwoofer correcting the acoustic problems caused by the other. The two subwoofers do not have to be identical.

A very good starting point for positioning two subwoofers is to place one each in the center of opposing walls. Experimenting with positioning as previously described should be used for determining the location of the second subwoofer, except in this instance one is listening for the minimum amount of bass output.

Control Settings

Properly integrating a subwoofer into your audio system requires the adjustment of 3 fundamental settings:

Volume: To balance with the volume of the rest of the speakers in the audio system. The key to the adjustment is to achieve a sense of balance, so neither the volume of the speakers nor the subwoofers stand out above the other. The goal is to have an even representation of the entire frequency range.

Crossover: The frequency range which the subwoofer is expected to play. If the frequency response of your speakers is such that the subwoofer's crossover frequency controls must be set higher than about 80Hz to avoid gaps in the overall system response, then you might be able to localize specific sounds from the subwoofer. These sounds may seem to come from beside or behind you. One solution is to ensure the subwoofer is in the front of the listening area; another is to use multiple subwoofers to diffuse such sounds.

Phase: Ensure the information from speakers and subwoofers arrive at the listening area at the same time.

Note: The Subwoofer Volume Level and Crossover Control are interactive. Raising the latter while lowering the former can have the effect of extending deep-bass response somewhat, with a small sacrifice in overall loudness capability (this will still be well beyond the full-range loudness capability of most systems). In general, for well-recorded acoustic music the lowest Subwoofer Cut-Off Frequency setting that yields a smooth transition between subwoofer and main speakers is often the best choice, and will promote deeper low-bass extension.

Note: The Subwoofer Volume Level is not a bass-boost or volume control. It is a set-and-forget adjustment, not intended for day-to-day adjustment. Use your preamplifier or receiver/integrated amp tone controls to modify program tonal balance.

LFE and Mobile App Set-up

Making the necessary set-up adjustments is dependent on the capabilities of your chosen electronic equipment and how the connection has been made. There are two distinct methods.

Electronics with Subwoofer Pre-Out/LFE

If you have made the connection from the subwoofer pre out of your electronics to the LFE In of your BP 12 subwoofer, the adjustments will be carried out using the settings within the pre-amplifier of receiver. Audio Video receivers often refer to the subwoofer connection as the LFE (Low Frequency Effects) channel. Navigate through the electronics' settings menu to access the subwoofer's **volume**, **crossover**, and **phase** controls to make the necessary adjustments.

If your electronics are equipped with a microphone-based calibration system (e.g. Dirac), the processor will carry out the adjustments once you have done the required microphone measurements. No additional set up is required.

Electronics with Line Level Pre Out (Left & Right) - Mobile App

Line level connections send a full range audio signal to the subwoofer. The subwoofer's **volume**, **crossover**, and **phase** will require adjusting with the BP12 Mobile App. Simply download the PSB BP12 App (iOS or Android) and make the necessary adjustments instantaneously from your listening position. The App will guide you through the process.

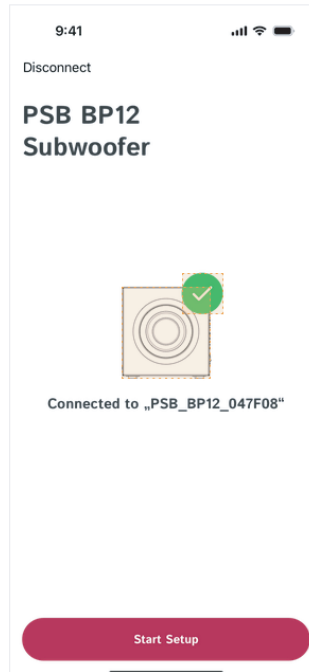

Set-up Calibration

- 1 The following procedure assumes your PSB subwoofer is installed and connected. Sit or stand in the area where most of the listening will take place.
- 2 Set Subwoofer Volume Level to 0, Crossover Control to 50Hz. Set any loudness, bass and treble, and/or equalizer controls on your preamplifier or integrated amplifier or receiver, or other components, to their nominal (midpoint or off) positions.
- 3 Play a familiar audio or video soundtrack that includes substantial deep-bass content over an extended section.
- 4 Gradually increase the Subwoofer Volume Level until you achieve natural balance between the subwoofers deep-bass output and your main left and right loudspeakers.
- 5 Slowly increase the Subwoofer Crossover to reach the best mid-bass blend with your main left and right speakers. This will be the point at which the upper bass retains solid impact and fullness. Boom or muddiness is the result if the control is too high. A thin, "reedy" quality to the mid-bass such as deep male voices (FM announcers; Darth Vader) is the result if the control is too low.

Adjust the Phase control between 0° and 180° several times, leaving it in the position that yields the fullest low to mid bass output. You will now probably want to repeat steps 3 and 4 to double-check the subwoofer blend.

Cycling through steps 3 and 4 several times with slightly different settings of both the Subwoofer Volume Level and Crossover control will help you get the most musical performance from your PSB Subwoofer and your system. The best combination is that which yields the most solid very-low-bass sounds, without mid-bass boom or a gap in response between the subwoofer and the main speakers.

Troubleshooting

Issue	Action
No sound/Status light not lit	<ol style="list-style-type: none">I. Ensure the power cord is connected to the subwoofer and plugged into a live AC outlet.II. Ensure the power cord is connected to the subwoofer and plugged into a live AC outlet.III. Check the main fuse located in the power cord socket and replace as required. If the new fuse also blows, the subwoofer amplifier requires service.
No sound/Status light remains red	<ol style="list-style-type: none">I. All PSB subwoofers utilize signal sensing auto on/off circuitry. If no signal is sent to the subwoofer, it will not power up and the on/standby indicator will remain red. When using the subwoofer output of a receiver or processor, no signal may be immediately present in this output. The subwoofer will only power up when bass signal appears at the subwoofer input.II. If the low level cable or speaker cable connection is poor or has been severed, the subwoofer will not power up. Swap cables to determine if this is the source of the problem.III. To ensure the problem is not associated with the subwoofer, rapidly disconnect and connect the subwoofer low level or high level input. If the subwoofer on/standby indicator then illuminates green, the receiver/processor/amp may not be sending a signal to the subwoofer. When driving the low level inputs from a subwoofer output, ensure the receiver/processor is correctly configured to provide signal at the subwoofer output.
Sounds distorted	<ol style="list-style-type: none">I. Lower Bass Level if the subwoofer begins to sound distorted to determine if playback at a lower level solves the problem. If a slight reduction in level solves the problem, then the subwoofer level was too high. If the distorted sound remains at a low level, driver(s) may be damaged.
Hum	<ol style="list-style-type: none">I. Hum that appears when using the subwoofer's low level input(s) is usually caused by using an inferior, damaged, exceptionally long low level cable or cables routed near high current wiring/appliances. Replace/shorten the low level cable connecting the subwoofer to the source equipment (receiver or processor). Low level cable runs of longer than 20 feet may require the use of a line driver (not available from PSB).II. Hum heard when using the subwoofer's high level input(s) is usually caused by an intermittent or missing positive or negative connection. Ensure there is a good connection between all speaker wires connecting the subwoofer and receiver/amplifier.III. If the subwoofer high level connection is routed through a switch box, ensure the box shorts the positive and negative connections together when the subwoofer should be inactive. Hum will result if the switch box floats the positive or negative connection.IV. Decreasing the volume control of the subwoofer and increasing the volume control of the receiver/processor/amplifier subwoofer output can sometimes reduce hum to an acceptable level.

Protecting your Investment

For long lasting enjoyment of your PSB product, you should respect their limits and avoid excessive volume levels for music or movie playback. Excessive volume levels can damage all types of speakers. If your speakers are pushed to excessive volume levels, they could be driven into "clipping", which may result in severe and/or permanent damage.

If listening to your speakers at loud levels, listen carefully for any signs of harsh, distorted midrange and diminishing precision. If detected, turn the volume down immediately.

NEVER TEST PEAK LISTENING LEVELS OF YOUR SPEAKERS BY TURNING THE VOLUME TO THE MAXIMUM LEVEL.

Care and Cleaning

For safe, sanitary use, it is essential to maintain and clean your speakers periodically. However, excessive cleaning may cause damage and jeopardize the longevity of the product. When not in use, avoid storing in extreme hot or cold temperatures and humidity, and avoid exposure to liquids.

Packaging

We highly recommend retaining all product packaging for any necessary transporting. To transport, carefully place the speakers into their original packaging and close each panel.

Cabinet Care

PSB cabinets have varying materials and finishes, including wood veneers, vinyl, anodized aluminum, and high gloss, and should be treated with the same care you would with similar finishes such as on furniture. Dust lightly with a soft cloth, avoiding abrasive materials that will cause permanent damage to the cabinet. If necessary, wipe carefully with a cloth slightly dampened with water-based cleaner to remove heavy soil.

Drivers and Port Care

During light cleaning, avoid touching speaker diaphragms as it could cause permanent damage to the tweeter and/or drivers. To clean the driver ports, we suggest using a lint-free cloth.

Environmental Protection

At the end of its useful life, this product must be returned to a collection point for the recycling of electrical and electronic equipment. Do not dispose with regular household waste.

See your dealer if you require service. Authorized PSB dealers are equipped to handle almost all problems. You may locate your nearest PSB authorized dealer on-line at www.psbSpeakers.com. If the problem is not resolved, please contact us, providing the model name, serial number, date of purchase, dealer name, and a full description of the problem.

We appreciate your purchase, and hope this owner's guide helps you enjoy the exceptional performance that PSB speaker systems have to offer. We wish you many years of enjoyable listening!

Specifications

FREQUENCY RESPONSE

On Axis @ 0° ± 3dB 25Hz - 150Hz
LF Cutoff -10dB 17Hz

AMPLIFIER POWER (Internal Amplifier)

Continuous Power 2 X 500W
Amplifier Purifi
DSP Analog Devices
LED Indicator Red: Standby
Green: On
Blue/Red: Bluetooth Pairing

ACOUSTIC DESIGN

Woofer (Nominal) 12" (305mm)
Carbon Fibre Cone
High Density Rubber Surround
3 1/2" (89mm) Voice-Coil
150 oz (4252 g) Magnet
Steel Basket

Crossover VARIABLE 30Hz - 150Hz
LFE setting (350Hz)

Design Type Sealed

SIZE (W x H x D)

Net Dimensions 18.9" x 19.3" x 18.9"
(480 x 490 x 480 mm)

Gross Dimensions 26.75" x 26.75" x 25.38"
(680 x 680 x 645 mm)

*Gross dimensions include / knobs / speaker terminals / feet

WEIGHT

Net Weight 132 lbs (60 kg)
Shipping Weight 137 lbs (62.5 kg)

FINISH

Automotive Paint & Clear Coat Basalt Brown, Carbon Grey
Feet Iso Acoustics

FEATURES

IOS/Android Mobile App Control Volume
Crossover
Phase Control 0°-180°

Connections Balanced XLR Inputs: LFE or Left/Right
Unbalanced RCA Inputs: LFE or Left/Right
12V Trigger Input

Other Universal Voltage
(100V-240V, 50/60Hz)
North America and European power cords supplied
Auto On/Standby

Energy Star Compliance 0.5W Standby

PSB Speakers
633 Granite Court Pickering, Ontario. L1W 3K1
CANADA

www.psbSpeakers.com
888-772-0000
(905) 831-6555
Fax: 905-831-6936

psb
SPEAKERS