

# TOWER®

T17013  
Vortx 4L Digital Air Fryer

Safety and Instruction Manual With Recipes

**PLEASE READ CAREFULLY**



\*Subject to registering Your Extended Guarantee online at [www.towerhousewares.co.uk](http://www.towerhousewares.co.uk).

# TOWER

over 100 years of quality

**1912** Midland Metal Spinners was founded by George Cadman, who was then 65 years old, as a metal holloware manufacturing company, in St. Mark's Street, Wolverhampton. They later moved into the Tower and Fort Works in Pelham Street, which ultimately gave rise to the famous Tower brand name.

**1937** Tower exhibited some of their latest holloware designs at the British Industries Fair. As you can see from the original poster, their stand No. A410 must have been a great sight as it promoted their "Beautiful, inexpensive, untarnishable Plate, at prices all can afford to pay".



**1961** Tower became one of the largest manufacturers of aluminium holloware, electric kettles, tea pots and other household articles with over 1,000 employees.

**1974** Russell Hobbs took ownership of the expanding Tower brand.

## What is Vortx?

Vortx Technology is a revolutionary cooking method that is faster and more efficient than traditional cooking methods. Eliminating slow and uneven cooking, Vortx technology uses a circular heating matrix to draw in cold air through the top of the unit, forcing it through a downward fan

to evenly distribute super-heated air in and around the food in the frying basket below. By encircling food with hot air, Vortx ensures evenly cooked, crisp results each and every time with no need for oil.

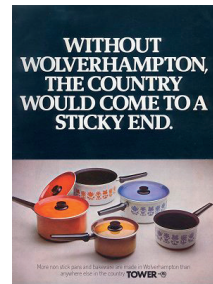

## Towerbrand



# Contents:

Please read this Manual carefully **BEFORE** using the Tower Vortex 4L Digital Air Fryer for your own safety.

Thank you for purchasing this Tower Vortex 4L Digital Air Fryer from the Tower range of products.

It has been designed to provide many years of trouble-free cooking.

There are many benefits to using a Vortex Digital Air Fryer:

- Enjoy healthier versions of traditionally fried family favourites. Requiring little to no oil, this revolutionary cooking system is ideal for baking, frying, roasting and grilling making it extremely versatile, allowing you to create food with up to 80% less fat.
- With a 4 litre frying basket, you can create up to 5 delicious portions if required, making it great for families.
- The easy to use digital display means that there are no complicated settings, allowing you to easily select your desired time and temperature settings, with both temperature and the remaining cooking times displayed on the built-in LED screen.

1. Specifications  
*Components and structure*
2. Technical data
3. Important Safety Information
4. Using your Appliance
5. Weights & Measures
6. Troubleshooting
7. Cleaning & Care
8. Recycling
9. Wiring Safety
10. Warranty Information
11. Your Receipt
12. Recipes  
*Homemade Fries*  
*Homemade Onion Rings*  
*Chicken Wings*  
*Salmon Fish Cakes*  
*Mixed Roasted Vegetables*

*See back page for Customer Service Information.*

# 1 - Specifications:

This box contains:  
Frying Basket  
Grill Shelf  
Instruction Manual

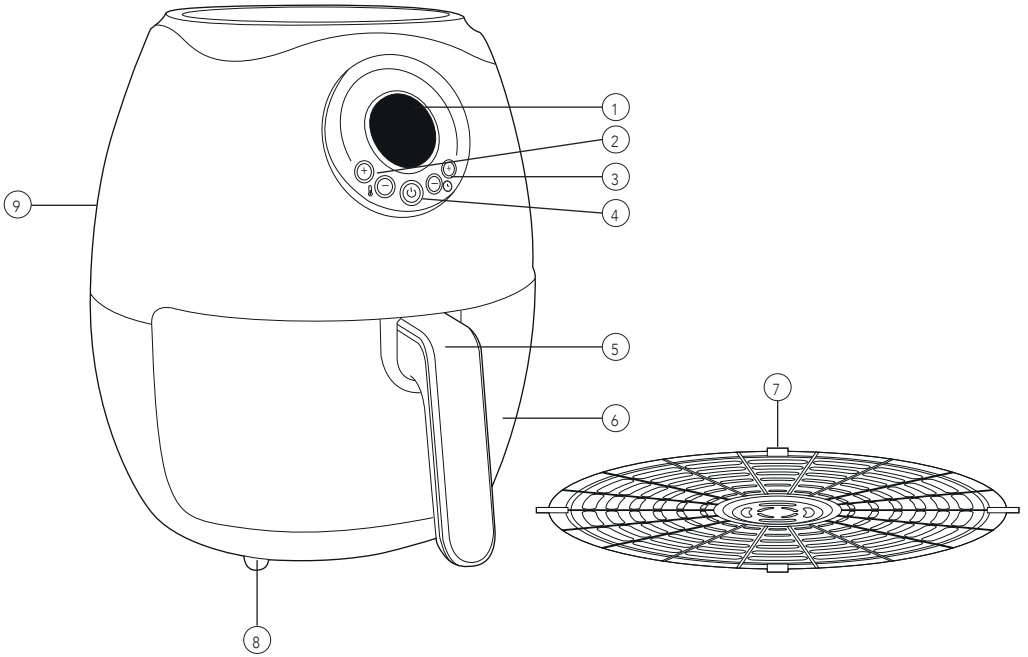

## Structure of your appliance:

- |                                |                              |                                    |
|--------------------------------|------------------------------|------------------------------------|
| 1. LED Display                 | 4. Power Button              | 7. Grill Shelf                     |
| 2. Temperature Control Buttons | 5. Basket Handle             | 8. Non Slip Feet                   |
| 3. Timer Control Buttons       | 6. Frying Basket (not shown) | 9. Air Outlet Openings (not shown) |

## 2 - Technical Data:

Description:	Vortex 4L Digital Air Fryer
Model:	T17013
Rated Voltage:	220-240V
Frequency:	~50Hz
Power Consumption	1700W

### Documentation

We declare that this product conforms to the following product legislation in accordance with the following directive(s):

2014/108/EU	Electromagnetic Compatibility Directive.
2014/95/EU	Low Voltage Directive.
2011/65/EU	Restriction of Hazardous Substances Directive.
1935/2004/EC	Materials & Articles in Contact With Food (LFGB section 30 & 31).
2009/125/EC	Eco-Design of Energy Related Products.

RKW Quality Assurance, United Kingdom.

## Guarantee:

All accessories are covered by the warranty. The main body and housing are guaranteed for the extended free warranty subject to registration. If any defect arises due to faulty materials of workmanship, the faulty products must be returned to the place of purchase. Refund or replacement is at the discretion of the retailer.

Should you encounter problems or require a replacement part, contact The Tower Customer Service Department on: +44 (0) 333 220 6066.

Any necessary spare parts may be ordered from the Tower website. Your warranty becomes void should you decide to use non Tower spare parts. Spare parts can be purchased from [www.towerhousewares.co.uk](http://www.towerhousewares.co.uk)

### 3 - Important Safety Information:

Please read these notes carefully **BEFORE** using your Tower appliance

- Check that the voltage of the main circuit corresponds with the rating of the appliance before operating.
- If the supply cord or appliance is damaged, stop using the appliance immediately and seek advice from the manufacturer, its service agent or a similarly qualified person.
- **WARNING:** Do not allow the power cord to hang over the edge of a table or counter. Serious burns may result from the Vortex being pulled off of a surface where it may be grabbed by children or become entangled with the user.
- Do not carry the appliance by the power cord or remove the plug from the socket using the cord as this may damage the cable.
- Do not use any extension cord with this appliance.
- Switch off at the wall socket then remove the plug from the socket when not in use and before cleaning.
- Switch off at the wall socket and unplug before fitting or removing tools/ attachments, after use and before cleaning.
- Close supervision is necessary when any appliance is used by or near children.
- This appliance should only be used by or under the supervision of a responsible adult.
- Cleaning and user maintenance should not be undertaken by children without supervision.
- Take care when any appliance is used near pets.
- Do not use this product for anything other than its intended use.
- This appliance is for household use only.
- This appliance includes a heating function.
- Please ensure that the appliance is used on a stable, level, and heat resistant surface.
- Do not immerse cords, plugs or any part of the appliance in water or any other liquid.
- Do not use the appliance outdoors.

- Do not place the Vortex on or near combustible materials such as a tablecloths or curtains.
- Do not place the Vortex against a wall or against other appliances. Leave at least 10cm free space on the back and sides and 10cm free space above the appliance.
- Allow the Vortex to cool down for approx. 30 minutes before you handle or clean it.
- Ensure that all burnt remnants are removed.
- During hot air frying, hot steam is released through the air outlet openings, ensure that these air outlets are kept clear at all times.
- Keep your hands and face at a safe distance from the steam and from the air outlet openings.
- Hot steam and air may escape when you remove the frying basket from the Vortex.
- Any baking trays or oven dishes used in the Vortex will become hot. Always use oven gloves when handling or removing anything from the Vortex.
- **WARNING:** Do not fill the Vortex pan with oil as this may cause a fire hazard.
- Always place ingredients to be fried in the basket.
- Do not place anything on top of the Vortex.
- Do not place wet or particularly oily foods into the Vortex.
- In the unlikely event the appliance develops a fault, stop using it immediately and seek advice from the service department:  
**+44 (0) 333 220 6066**

## 4 - Using The Vortx



### Automatic Switch Off:

The Tower Vortx features a built in 30 minute digital timer, which will automatically turn off the Vortx when the timer reaches zero. To manually switch off the Vortx, press the central power button. The centigrade symbol will disappear showing that the Vortx is cooling down. Wait for 30 seconds and the Vortx will switch off

### Removing the Frying Basket:

The frying basket can be removed fully from the Vortx. Firmly pull on the handle to slide the frying basket out of the Vortx.

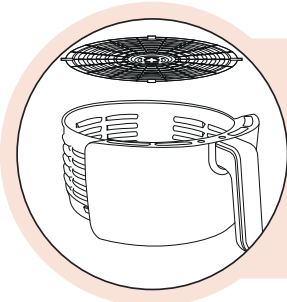

### Fitting the Grill Shelf:

To fit the grill shelf into the frying basket simply lift the grill shelf using the central handle and place inside the frying basket. To remove, carefully lift the grill shelf out from the frying basket using the central handle.

**NOTE:** The grill shelf will become very hot during use and should be allowed to cool fully before handling.

### Using the appliance:

1. Ensure that the Vortx is placed on a stable, even, heat resistant surface.
2. Place the grill shelf into the frying basket with the central handle facing upwards.
3. When using the appliance from cold, allow the Vortx to pre-heat for 2 minutes by using the timer arrow buttons to add 2 minutes to the digital timer and setting the temperature to 150°C using the temperature arrow buttons. Press the power button to commence heating. When the time has elapsed, add your ingredients into the frying basket, ensuring that the basket is not filled beyond the maximum fill line.
4. After placing your food into the fryer basket, place the basket back into the Vortx using the handle to push until it clicks into place.

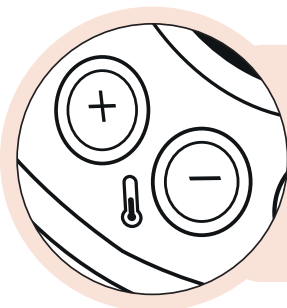

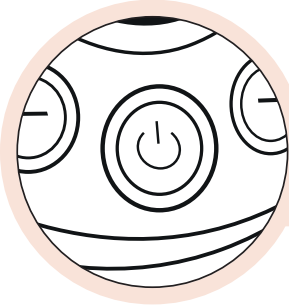

5. To start the Vortex, press the power button, then use the temperature arrow buttons to set the desired temperature. Select the required amount of time using the timer arrow buttons.
6. Press the power button again to begin cooking. The power light and heat indicator light will come on, and the timer will begin counting down the set cooking time.
7. When cooking is finished, the timer will chime. Use the handle to remove the basket and place on a heat-resistant surface.
8. Check to see if your food is cooked. If the food is not quite cooked enough, simply place the fryer basket back into the Vortex and set the timer for the required extra time, press the power button and allow to cook as desired.

**NOTE:**

- During the cooking process the heat indicator light will cycle on and off to show that the Vortex is maintaining the set temperature.
- Some ingredients may require shaking in the pan during cooking. Check the reference table for notes. To shake ingredients, pull the basket out of the Vortex and using the handle, simply shake before sliding it back into the Vortex.



**Timer:**

The Vortex features a 30 minute digital timer with an end cooking chime. To set the timer, use arrow buttons to increase or decrease the selected time in 1 minute increments, the remaining time will be displayed on the LED screen. When the selected cooking time has elapsed, a chime will sound to indicate that cooking has finished.

### Settings:

The below reference table contains our recommended temperature and time settings for a range of basic ingredients. Please note, these settings are indications only and can vary between the size, shape and brand of your ingredients. Always refer to the packet instructions prior to cooking.

Food Type	Min-Max Amount (g)	Time (min)	Temperature (°C)	Shake
Thin frozen fries	450-1000	9-16	200	√
Thick frozen fries	450-1000	15-22	200	√
Homemade fries	450-1000	15-22	200	√
Homemade potato wedges	450-1000	18-22	180	√
Homemade potato cubes	450-1100	12-18	180	√
Potato Rosti	350	10-15	180	√
Onion Rings	200-400	12-15	180	√
Steak	150-750	8-12	180	
Pork Chops	150-750	10-14	180	
Hamburger	150-750	7-14	180	
Sausage Roll	150-750	4-8	200	
Drumsticks	150-750	12-18	180	
Chicken breasts	150-750	10-15	180	
Spring Rolls	150-600	6-10	200	√
Frozen Chicken Nuggets	150-750	6-10	200	√
Frozen Fish Fingers	150-600	6-10	200	√
Frozen Breaded Cheese Snacks	150-600	6-10	180	√
Mixed Vegetables	150-600	8-12	160	√
Cake	450	20-25	160	
Quiche	600	18-20	180	

**NOTE:** The Vortex uses hot air heating technology. Never pour oil or fat directly into the fryer where oil is required, lightly coat the ingredients before adding to the fryer basket.

**TOP TIPS:** For extra crispy homemade fries, first blanch your thinly cut potato and dry thoroughly before lightly coating in oil. Place in the Vortex and cook until 2/3 cooked. Remove and allow the fries to cool down before returning to the Vortex to complete cooking.

Because the revolutionary Vortex technology begins to heat the air inside the appliance instantly, removing the basket briefly barely disturbs the cooking process. Small ingredients usually require a slightly shorter preparation time than larger ingredients.

Shaking smaller ingredients halfway through the cooking time optimizes the end result and can help prevent unevenly fried ingredients.

Any snacks such as garlic mushrooms, chicken nuggets or breaded cheese snacks that can be cooked in a conventional oven can also be cooked in the Vortex.

You can use your Tower Vortex to reheat food easily. Simply set the temperature to 150°C for up to 10 minutes.

To bake cakes or quiches, place a baking tin and oven dish in the Vortex, to protect.

When cooking certain foods like sausages, some excess oil and grease can be released during cooking. Do not tip these ingredients onto the plate straight from the fryer basket, use tongs to remove.

# 5 - Weights & Measures

Check these charts for basic imperial to metric conversions of weights.

Metric	Imperial	US cups
250ml	8 floz	1 cup
180ml	6 fl oz	3/4 cup
150ml	5 floz	2/3 cup
120ml	4 floz	1/2 cup
75ml	2 1/2 floz	1/3 cup
60ml	2 floz	1/4 cup
30ml	1 floz	1/8 cup
15ml	1/2 floz	1 tablespoon

Imperial	Metric
1/2 oz	15g
1 oz	30g
2 oz	60g
3 oz	90g
4 oz	110g
5 oz	140g
6 oz	170g
7 oz	200g
8 oz	225g
9 oz	255g
10 oz	280g
11 oz	310g
12 oz	340g
13 oz	370g
14 oz	400g
15 oz	425g
1 lb	450g

## Food Allergies

Important Note: Some of the recipes contained in this document may contain nuts and/or other allergens. Please be careful when making any of our sample recipes that you ARE NOT allergic to any of the ingredients. For more information on allergies, please visit the Food Standards Agency's website at: [www.food.gov.uk](http://www.food.gov.uk)

## 6 - Trouble Shooting & Faq's

Problem	Possible Cause	Solution
The Vortx does not work.	<p>The appliance is not plugged in.</p> <p>You have not set the timer.</p> <p>The fuse is not working.</p>	<p>Plug the appliance into an earthed wall socket.</p> <p>Set the digital timer using the timer arrow buttons and press the power button to begin cooking.</p> <p>Check the fuse and replace if necessary.</p>
The ingredients in the Vortx are not cooked.	<p>The Vortx is overfilled.</p> <p>The set temperature is too low.</p> <p>The food has not cooked for long enough.</p>	<p>Place smaller amounts of food into the fryer basket. Try cooking food in small batches.</p> <p>Select a higher temperature using the temperature arrow buttons.</p> <p>Add additional time to the digital timer and cook until food is cooked through.</p>
The ingredients in the Vortx are fried unevenly.	<p>Certain types of ingredients need to be shaken halfway through the preparation.</p>	<p>Ingredients that lie on top of or across each other (e.g. fries) need to be shaken halfway through the preparation time.</p>
The fryer basket won't fit into the appliance properly.	<p>The fryer basket has been filled above the maximum fill line.</p> <p>The frying basket is not placed into the Vortx correctly.</p>	<p>Do not fill the fryer basket above the maximum fill line marked inside the fryer basket.</p> <p>Ensure that the fryer basket is not obstructed, slide the frying basket into the Vortex until it clicks into place.</p>
White smoke comes out from the appliance.	<p>You are preparing greasy ingredients.</p> <p>The pan still contains grease residue from the previous use.</p>	<p>When you prepare greasy ingredients in the Vortx, excess oil will leak into the pan and when heated may produce smoke. This will not affect the appliance or the end result.</p> <p>White smoke is caused by grease heating up in the pan. Make sure you clean the pan properly after each use.</p>
Fresh fries are fried unevenly in the Vortx.	<p>You did not use the right potato type.</p> <p>You did not rinse the potato sticks properly before you fried them.</p>	<p>Use fresh potatoes and make sure that they stay firm during frying.</p> <p>Rinse the potato sticks thoroughly to remove excess starch.</p>
Fresh fries are not crispy when they come out of the Vortx.	<p>The crispiness of the fries depends on the water content of the potatoes used.</p>	<p>Make sure you dry the potato sticks properly before you add the oil.</p> <p>Use smaller potato sticks and coat lightly in oil for a crispier result.</p>

## 7 - Cleaning & Care

It is important to clean your Vortex after every use. Prior to cleaning, switch the appliance off at the mains, remove the plug and allow the appliance to cool.

**NOTE:** Removing the frying basket will allow the appliance to cool quicker. Always ensure that the Vortex has cooled fully prior to cleaning.

The removable frying basket is dishwasher safe.

To clean the base unit, simply wipe with a damp cloth. A small amount of detergent can be used if the appliance is heavily soiled. Do not immerse any part of the appliance in water.

To protect the frying basket and grill shelf's non-stick coating, clean using warm soapy water and do not use abrasive scouring pads, steel wool or strong solvents. For particularly stubborn dirt or oil in the frying basket or on the grill shelf, soak in hot soapy water for up to 10 minutes and wipe away with a soft cloth.

### **IMPORTANT!**

Allow the Vortex to dry fully before using or storing. Store on a flat, dry, level surface out of reach of children.

## 8 - Recycling

### DISPOSAL OF THE UNIT

Appliances bearing the symbol shown here may not be disposed of in domestic rubbish. You are required to dispose of old electrical and electronic appliances like this separately.

Please visit [www.recycle-more.co.uk](http://www.recycle-more.co.uk) or [www.recyclenow.co.uk](http://www.recyclenow.co.uk) for access to information about the recycling of electrical items.

Please visit [www.weeeireland.ie](http://www.weeeireland.ie) for access to information about the recycling of electrical items purchased in Ireland.

The WEEE directive, introduced in August 2006, states that all electrical items must be recycled, rather than taken to landfill.

Please arrange to take this appliance to your local Civic Amenity site for recycling, once it has reached the end of its life.



# 9 - Wiring Safety for UK Use Only

## IMPORTANT

As the colours in the mains lead of this appliance may not correspond with the coloured markings identifying the terminals in your plug, please proceed as follows:

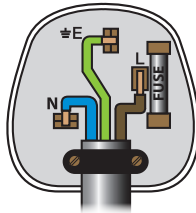

The wires in the mains lead are coloured in accordance with the following code:

Blue neutral [N] Brown live [L]  
Green/Yellow [EARTH] 

Plug Fitting Details (Where Applicable).

The wire coloured blue is the neutral and must be connected to the terminal marked [N] or coloured black.

The wire coloured brown is the live wire and must be connected to the terminal marked [L] or coloured red.

The wire coloured green/yellow must be connected to the terminal marked with the letter [E] or marked .

On no account must either the brown or the blue wire be connected to the [EARTH] terminal .

Always ensure that the cord grip is fastened correctly.

The plug must be fitted with a fuse of the same rating already fitted and conforming to BS 1362 and be ASTA approved.

If in doubt consult a qualified electrician who will be pleased to do this for you.

Non-Rewireable Mains Plug

If your appliance is supplied with a non-rewireable plug fitted to the mains lead and should the fuse need replacing, you must use an ASTA approved one (conforming to BS 1362 of the same rating).

If in doubt, consult a qualified electrician who will be pleased to do this for you.

If you need to remove the plug - disconnect it from the mains - and then cut it off the mains lead and immediately dispose of it safely. Never attempt to reuse the plug or insert it into a socket outlet as there is a danger of an electric shock.

**WARNING:**  
This appliance **MUST** be earthed

# 10 - Warranty



**We hope that you will enjoy your Tower Vortex for many years.**

As a thank you for purchasing one of our fantastic products, we are giving you 3 years peace of mind.

To receive your 3 year guarantee, simply register your appliance online by visiting [www.towerhousewares.co.uk](http://www.towerhousewares.co.uk)



This product is guaranteed for 12 months from the date of original purchase. If any defect arises due to faulty materials of workmanship, the faulty products must be returned to the place of purchase. Refund or replacement is at the discretion of the retailer.

#### The Following Conditions Apply:

- The product must be returned to the retailer with proof of purchase.
- The product must be installed and used in accordance with the instructions contained in this instruction guide.
- It must be used only for domestic purposes.
- It does not cover wear and tear, damage, misuse or consumable parts.
- Tower has limited liability for incidental or consequential loss or damage.

This guarantee is valid in the UK and Ireland only.

The standard one year guarantee is only extended to the maximum available for each particular product upon registration of the product within 28 days of purchase. If you do not register the product with us within the 28 day period, your product is guaranteed for 1 year only.

To validate your extended warranty, please visit [www.towerhousewares.co.uk](http://www.towerhousewares.co.uk) and register with us online. Alternatively, call our customer registration line on **+44 (0) 333 220 6066**.

Please note that length of extended warranty offered is dependent on product type and that each qualifying product needs to be registered individually in order to extend its warranty past the standard 1 year. Extended warranty is only valid with proof of purchase.

# 11 - Your Receipt

Affix your store receipt to  
this page for safe keeping.









# TOWER<sup>®</sup>

Recipes

Recipes for use with the T17013 Vortex 4L Digital Air Fryer.

For more great recipes and inspiration from the  
Tower Kitchen, visit

[www.towerhousewares.co.uk/blog](http://www.towerhousewares.co.uk/blog)

# Homemade Fries

## Ingredients

400g white potatoes  
½ tsp olive oil  
Salt & pepper to taste

## Method

1. Peel the potatoes and cut into sticks (around 8x8mm thick)
2. Soak the potato chips in water for around 30 minutes before removing and drying thoroughly with kitchen towel.
3. Lightly coat the potato sticks in ½ tsp of olive oil and season well with salt and pepper.
4. Add the chips to the Vortex frying basket, set the temperature to 180°C and the digital timer to 18 minutes then press the power button to commence cooking.
5. Cook for 9 minutes, remove the frying basket, gently shake and place the frying basket back into the Vortex. Cook for a further 9 minutes.
6. When the timer bell chimes, remove the frying basket and check that the chips are golden brown and piping hot.

**TOP TIP:** Make sure to check your food regularly as it cooks as cooking times can vary depending on the size and thickness of your ingredients.



# Homemade Onion Rings

## Ingredients

400g white onions  
Milk  
Plain flour seasoned  
with salt & pepper

## Method

1. Slice the onions into rings.
2. Dip the onions in milk.
3. Dip the onions in the seasoned flour.
4. Drizzle the onion rings lightly in olive oil.
5. Add the onion rings to Vortex frying basket, set the temperature to 180°C and the digital timer to 12 minutes, then press the power button to commence cooking.
6. After 6 minutes, remove the frying basket, gently shake, then place the frying basket back into the Vortex to cook for a further 6 minutes.
7. When the timer bell chimes, remove the frying basket and check that the onion rings are golden brown and piping hot.



# Chicken Wings

## Ingredients

750g chicken wings  
240ml hot sauce

## Method

1. Place the chicken wings into the Vortex frying basket, set the temperature to 180°C and the digital timer to 12 minutes, then press the power button to commence cooking.
2. Half way through cooking, remove the cooking basket and shake the chicken wings. Return the frying basket to the air fryer and continue cooking.
3. When the timer chimes, remove the frying basket and check that the chicken wings are cooked through. If not, return to the Vortex and continue cooking until the chicken is cooked to the bone.
4. Remove the chicken wings from the frying basket with tongs, add to a bowl with the hot sauce and toss to coat.



# Salmon Fish Cakes

## Ingredients

½ onion  
2 sprigs fresh parsley  
Pinch of chilli  
1 large salmon fillet  
5-6 tbsp breadcrumbs  
1 egg (lightly beaten)  
Seasoned flour  
Salt & pepper

## Method

1. Blend the onion and parsley for a few seconds, add the salmon, chilli, salt and pepper then blend for 5-10 seconds.
2. Transfer the mixture into a bowl, then fold in 2 tbsp breadcrumbs. Divide the mixture into 4 equal portions.
3. Roll each portion into a ball, coat in egg, then breadcrumbs, flatten the coated balls and add into the Vortex frying basket.
4. Set the temperature to 180°C and the digital timer to 15 minutes.
5. Halfway through cooking, remove the frying basket and turn the fishcakes. Return to the Vortex and continue cooking.
6. When the timer chimes, remove the frying basket and check that the fishcakes are golden brown and piping hot.



# Mixed Roasted Vegetables

## Ingredients

½ courgette  
1 red pepper  
1 small onion  
½ aubergine  
½ tsp olive oil  
Salt & pepper  
½ tsp mixed herbs

## Method

1. Slice the vegetables and add to a bowl.
2. Pour over the olive oil then add the mixed herbs, salt and pepper and toss the vegetables until fully coated.
3. Add the vegetables to the Vortex frying basket, set the temperature to 160°C and the digital timer to 8-12 minutes (depending on the size of your vegetables) then press the power button to commence cooking.
4. When the timer chimes, remove the frying basket and check that the vegetables are cooked through and piping hot.





# TOWER®

*thank you!*

We hope you enjoy your appliance for many years. As a thank you for purchasing one of our fantastic products, we are giving you an extra 2 years peace of mind.

\*To receive your extra 2 years guarantee, register your appliance online by visiting:

[www.towerhousewares.co.uk](http://www.towerhousewares.co.uk)

Should you have a problem with your appliance, or need any spare parts, please call our Service Department on:

**+44 (0) 333 220 6066**

Your warranty becomes void should you decide to use non Tower spare parts. Spare parts can be purchased from [www.towerhousewares.co.uk](http://www.towerhousewares.co.uk)

♥ *great british design, innovation and excellence since 1912*