

说明书尺寸

宽: 10.5CM

高: 14.5CM

时间:	24.06.14	产品型号:	H11英
尺寸:	105*145mm		
材质:	105g铜版纸		
工艺:	骑马订		

INSTRUCTION MANUAL

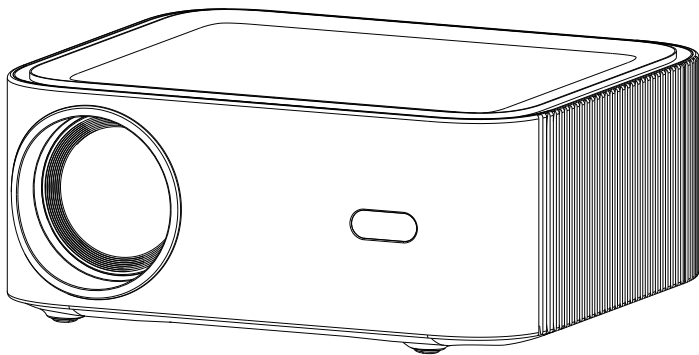

Model: H11

Please read this manual carefully
before using the projector.

Important Safety Considerations

Attentions:

Thank you for purchasing this series of video projectors.

Please read through this User's manual for proper use of this product.

Friendly Reminder:

- 1 Do not look directly into the lens while the projector is running, as strong light may damage your eyes.
- 2 Do not block the air outlet to prevent the projector from cooling down because internal electronics are damaged.
- 3 Keep the projector and accessories out of the reach of children.
- 4 Please make sure that the working environment of the projector is dry and ventilated.
- 5 To prevent electric shock, please keep the projector out of the rain and away from moisture, It is recommended to switch off the projector after it has run for 6 hours non-stop.
- 6 Do not press hard on the projector, as it may damage the product.
- 7 Do not throw, hit, or shake the projector to avoid damaging the circuit board.
- 8 Any questions after receiving the projector, please contact us, we will quickly and correctly solve your problem within 24 hours and give you a satisfactory answer.

Package contents

HDMI cable * 1

Power cord * 1

Remote control * 1

User Manual * 1

Projector description

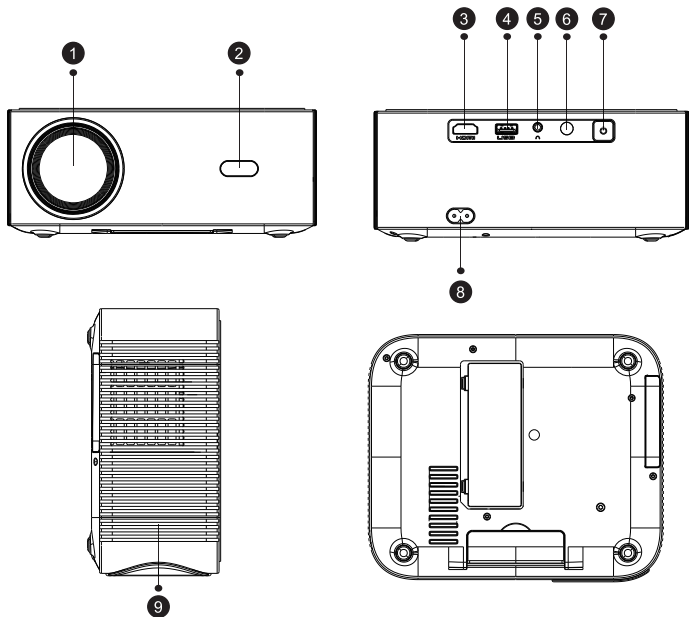

1. Lens
2. IR Receiver
3. HDMI Port
4. USB Port
5. Headphone Jack
6. IR Receiver
7. Power Switch
8. Power Jack
9. Cooling Window

Remote Control Button Function



Power button:
Turn on/off



Mute button:
Mute



Focus button:
Adjust focal distance



Input button:
Choose to enter the Application Center, HDMI



Back button:
return to last step



Quick Menu Key:
Enter the setting pop-up window interface



Home button:
short press and return to the homepage



Direction Buttons:
● Up ● Down
● Left ● Right
● OK



Volume button:
Volume-, Volume+



NETFLIX:
Direct enter NETFLIX



YouTube:
Direct enter YouTube



Prime video:
Direct enter PrimeVideo

● To avoid power shortage, please do not mix up the old and new batteries. To avoid battery leakage and corrosion, please take the battery out if do not use remote control for a long time.

Specification

Imaging technology	TFT LCD
Native resolution	1920*1080
Light source	LED
Focus mode	Electronic Focusing
Power input	100V-240V~50/60HZ
Output	Earphone
Speaker	4Ω3W
Unit size	200*167*80mm
Net weight	1.11KG
Throw ratio	1.35:1

Multimedia Supported Formats

Image Format	JPG / PNG / BMP / JPEG
Video Format	MP4 / MKV / WMV / RMVB / RM / AVI / FLV / TRP / VOB / 3GP / DIVX / TP / TS / MPG / M2TS / F4V / DAT
Audio Format	MP3 / AAC / WAV / FLAC / WMA / M4A

Power/Focus/KeystoneCorrection

1: Plug the power cord into a power outlet.

2: Press the button "⏻" on the remote control.

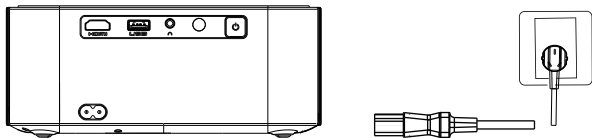

Electronic Focusing

Press the "⊖" and "⊕" buttons on remote control to adjust the clarity.

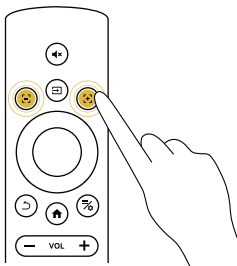

Keystone Correction

When the projector is placed at different angles, the projection will produce trapezoidal distortion, please use keystone correction to project correctly.

Connection

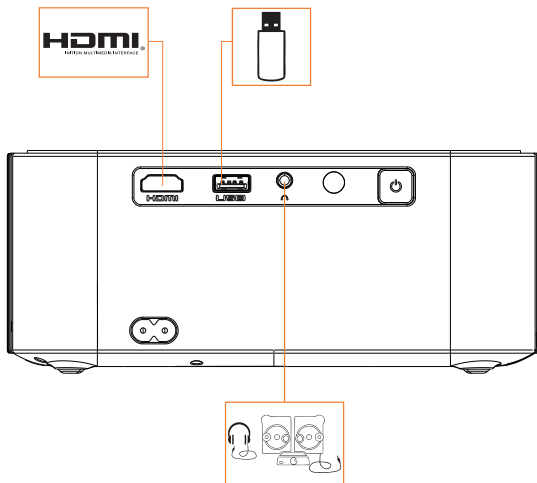

Add: Different brand laptop output keys are as follows:

Lenovo	Fn+F3
Dell	Fn+F8
HP	Fn+F4
ThinkPad	Fn+F7
Asus	Fn+F8
Acer	Fn+F5
Samsung	Fn+F4
Sony	Fn+F7

Fujitsu	Fn+F10
Haier	Fn+F3
NEC	Fn+F3
Panasonic	Fn+F3
Sharp	Fn+F5
Hitachi	Fn+F7
TOSHIBA	Fn+F5

The user of windows 7 or over windows 7. Simply press the  +P, select “copy” to connect. If the operation above is invalid, Please update the computer graphics driver.

Connecting

1. Connect a USB drive

Insert the USB flash drive, then click on the USB icon located at the top right corner. This will allow you to access the contents stored in the USB drive, just like the icon's position shown in the image below.

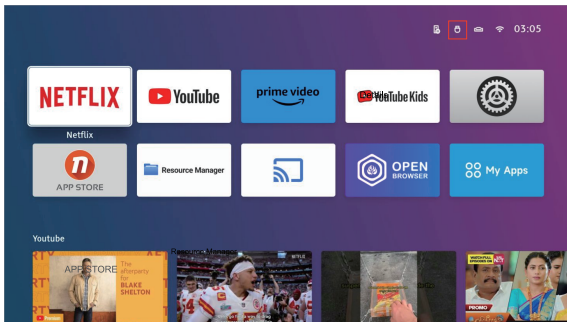

2. Connect 3.5mm audio devices

Support 3.5mm earphones and other cable sound devices.

Bluetooth Settings

Please note: The Bluetooth function is only compatible with audio output devices such as soundbars and Bluetooth speakers.

1. Tap on the "Setting" icon on the screen to access the settings options.

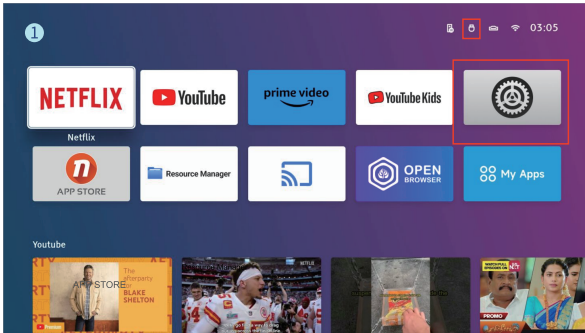

2. select "Bluetooth" and then click "OK", Choose "Scan Bluetooth Devices" and click "OK".

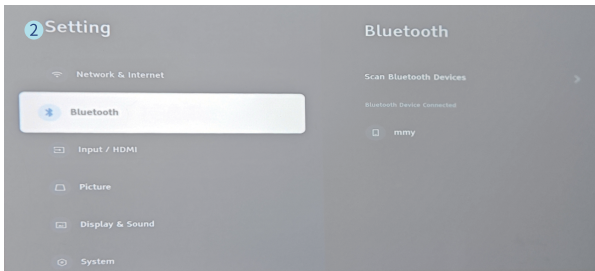

3.Now, it will search for Bluetooth speakers.

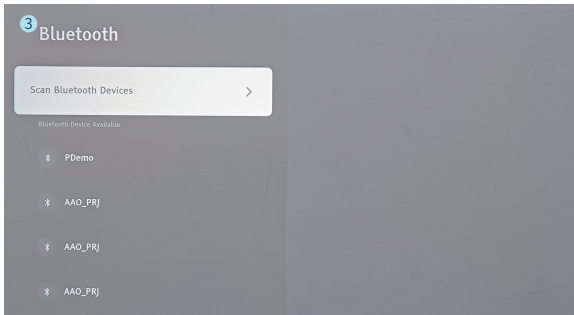

Projector Settings

Please set the option related to "Picture" on this screen
Zoom settings

1.From the home page, choose "Settings" and then click to enter the settings page.

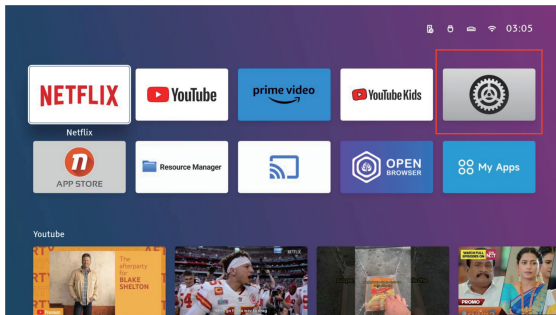

Projector Settings

2. Navigate to "Picture" in the settings menu, then select "Image Zoom"

To make adjustments, use the left and right buttons on the remote control.

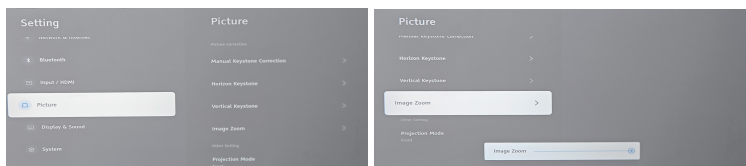

WIFI Setting

Click on "Settings" on the screen to enter the settings page. Search for your home network, and then enter the corresponding password to establish the connection, just like shown in the image below.



Keystone Correction

During the use of the projector, the position of the projector should be as perpendicular to the projection screen as possible to ensure the projection effect. If the verticality between the two cannot be guaranteed, the picture will appear trapezoidal. In this case, you need to use the keystone correction function to ensure that the screen is a standard rectangle.

1. Manual keystone correction: We need to manually adjust the settings step by step through the remote control. Click "Manual Keystone Correction" and use the remote control buttons to manually adjust the screen according to the fixed points provided on the projector screen.

2. Vertical keystone(up and down): The projector is not placed vertically, resulting in an up and down trapezoidal image. Vertical keystone correction can be used to standardize the picture.

3. Horizontal keystone(left and right): The angle of the projector is offset, causing the picture to appear left and right trapezoidal. The projected image can be adjusted to a standard image through horizontal keystone correction.

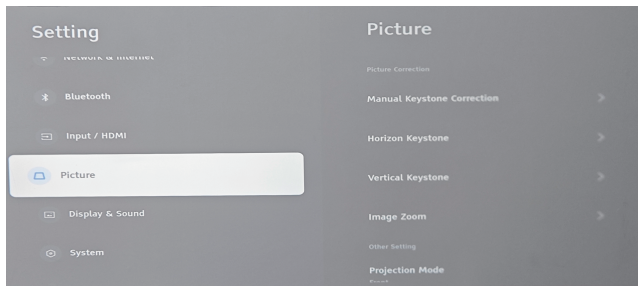

Projector Settings

Please set options related to "Settings" on this screen

1. Click "Menu" on the remote control to move to the settings menu.
2. Use Left and Right on the remote control to move to Settings.

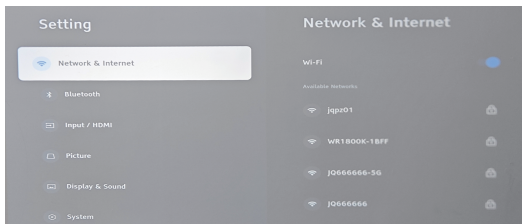

Language Settings

1. Set the language on your system (there are 23 languages). The initial setting is English.
2. Use " \wedge / \vee / \lt / \gt " on the projector or remote control to search for the language.

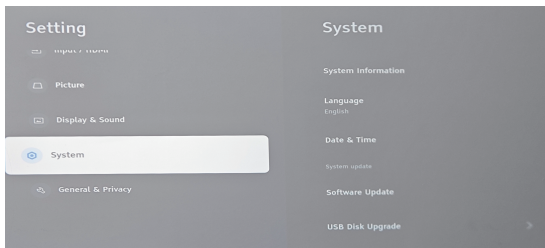

Projector Settings

Projection Mode Settings

Adjust the image upside down. You can get the desired image by clicking the "OK" key.

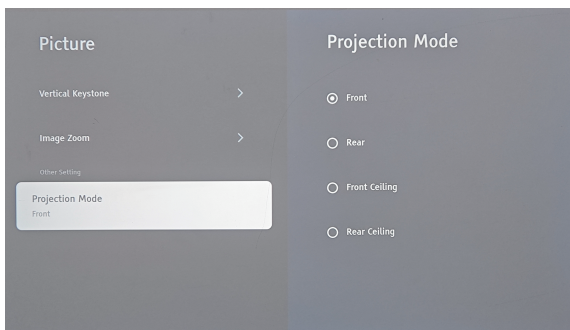

Restore Factory

Access the settings page, then choose and click on "System." Afterward, select "Restore Factory Settings" to reset to the original factory settings.

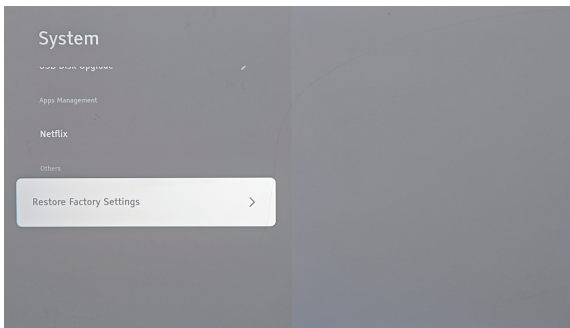

TOP SERVICE:

Any questions about this item, please

 US: 1-888-986-2646

 US: service@happrunlife.com



