

yuwell



YE655A Electronic Blood Pressure Monitor

User's Manual

JIANGSU YUYUE MEDICAL EQUIPMENT & SUPPLY CO.,LTD.
Sales Center Address: Huanyuan East Road No.1,Xuzhuang
Software Park, Nanjing, Jiangsu Province, P.R. China, 210000
Manufacturing Address: YunYang Industrial Park
DanYang, Jiangsu Province, P.R. China, 212300
<http://www.yuwell.com>

730161-0A 

Please read the user's manual closely before using!

Please follow the steps as shown below

Power-on

Connect the power source

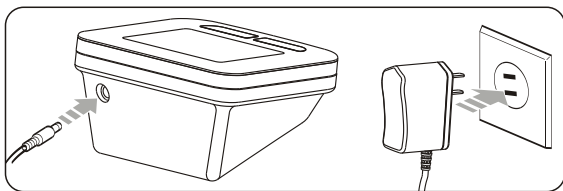

Or install four AA batteries

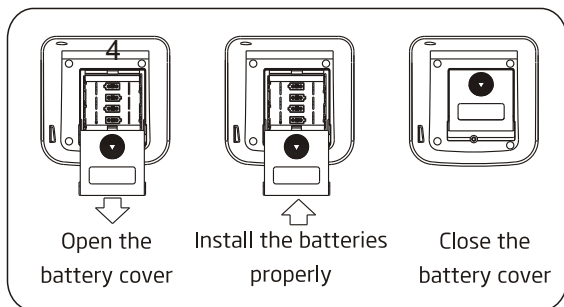

(Please turn to page 12 for details)

Measurement

1. Using method of cuff

Wearing the cuff and make the lower edge 2~3cm above the elbow, keep the air tube inside of the arm.

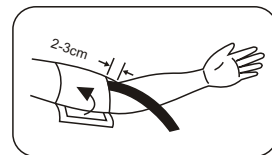
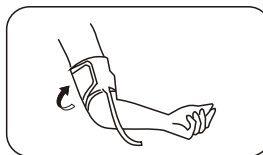

2. Measuring posture

Sit straightly, keep the center of cuff and heart at the same level.

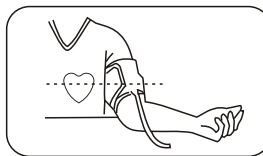

3. Start measuring

Sit still for 5 minutes and then Press the "  " Button to measure (Please turn to page 19 for details)

Check the records

Press the button of "  " to check the measuring records.

This monitor can display the average measurement and store 74 records. (Please turn to page 23 for details)

1. Main part

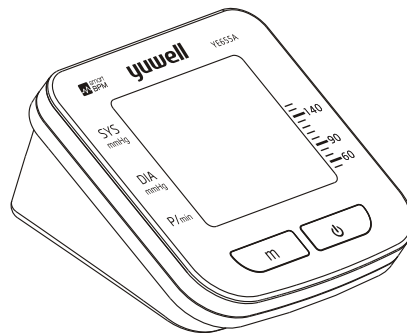

2. Cuff

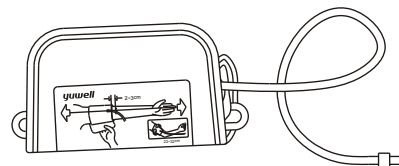

3. Accessories

User's manual, Warranty card, 4 AA batteries

1. Main part

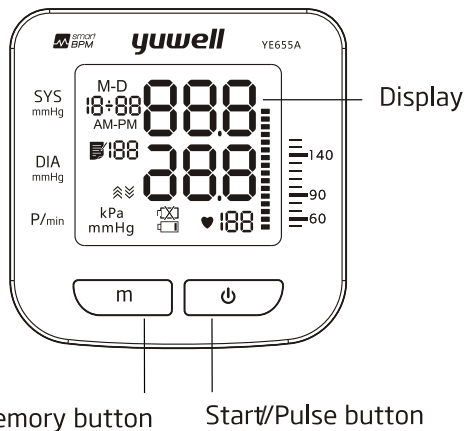

2. Cuff

The suitable upper-arm circumference of the cuff is 22cm 32cm

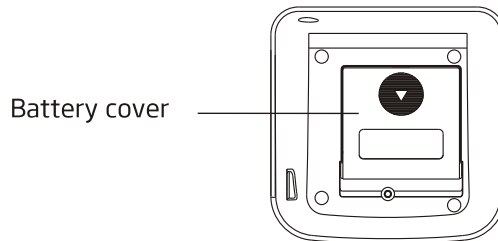
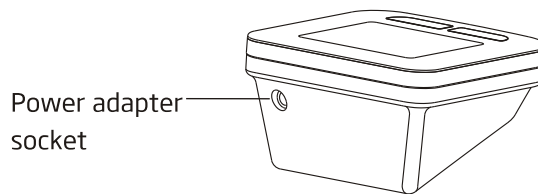
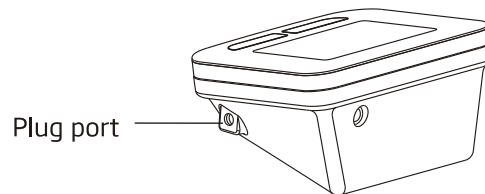
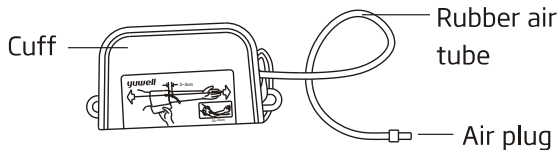

3. Display

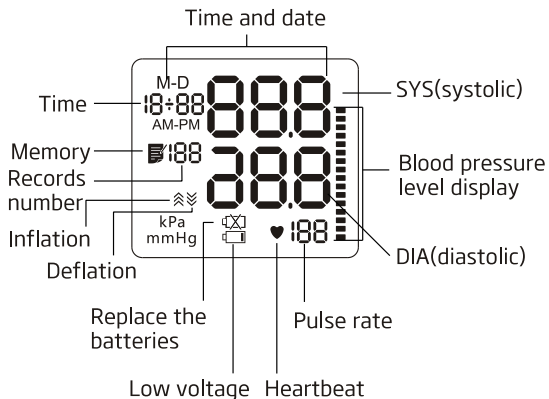

Pay attention with the symbols shown here to prevent harm or damage to the user.

Symbol	Description
	Attention! It might cause damage
	Prohibited
	Obligatory
	Pollution control symbol of electric products. The product can be safely and environmentally used in 10 years excluding batteries and cuff.
	Type BF application part
	Class II device
	Consult the manual
	Keep Upright
	Fragile
	Keep Dry







Application scope and attention items

1. Range of application









The monitor is used for measuring blood pressure of human body (adult older than 12, not suitable for new born baby)!

2. Attention items

 **Caution:** Pay attention to the following points when measuring or it may cause the incorrect results.

-  Sit still for 5 minutes before measuring to ensure quiet and stable mode.
-  Do not take the measurement while standing, walking or having body pressed.
-  Do not take the measurement after smoking, drinking wine or coffee (black tea).
-  Do not take the measurement after sport or bath.
-  Do not speak or move while measuring.
-  Do not move, shake arm or bend fingers while measuring.
-  Do not take the measurement at extreme temperature condition or the varied severely environment.

Application scope and attention items



-  Do not take the measurement in a moving vehicle.
-  Do not measure continuously. (2~3 minutes or more should be spared between two measurements).
-  Do not measure within 1 hour after meal.
-  Do not use mobile phone near the monitor.
-  **!** Please reinstall the batteries and start again if cannot measure.
-  **!** For patient of arrhythmia, measuring results may not be accurate.
-  Do not keep the cuff in the aerated state for a long time.
-  **Note:** Do not diagnose with the measurement, Please follow doctor's instruction.

Statement: If the monitor has not been stored in the required temperature and humidity range, it may not conformance to specification.

Battery installation

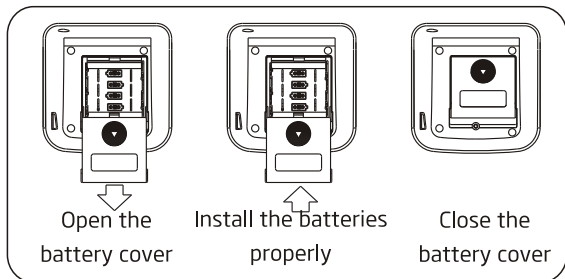
- ▶ Open the battery cover and install four AA batteries properly. Then close the cover with a click sound.







- ▶ The "  " icon appearing means the battery is low.
- ▶ The "  " icon appearing means the battery is running out. Please replace all the batteries.
- ▶ Please take out the batteries if the monitor will not be used for a long time (over three months).

⚠ **Note:** 6V/600mA DC external power can be connected to the monitor. (Please use the power adapter supplied by us.)



- ▶ Please take out the batteries if use the DC external power for a long time.

Time and date setting

The monitor will store the measuring results automatically by the management system. It is necessary to reset time and date after installing new batteries or connecting to DC power. Please operate as following steps. (For example: setting the date as 2015-1-15 and time as 08:28)

1. Year setting: Press both the "  " and "  " button for more than 3 seconds till the number starts flashing.
2. The year increases once press the "  " button.
3. Press the "  " button to switch to the month setting.
4. Using the same way for other settings.

MmHg/kPa setting

After finishing the date and time setting, pressing the "  " button to enter the mmHg/ kPa unit setting. Press the "  " button to switch between these two units. Finish by pressing the "  " button.

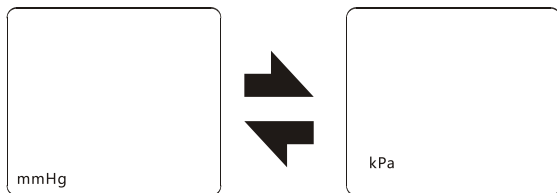

After unit setting, press the "  " button to shut down.

Using method of cuff

Tip!

Both arms can be measured.

Cuff connecting

Connect the air connector of the cuff to the socket which on the left side of the monitor.

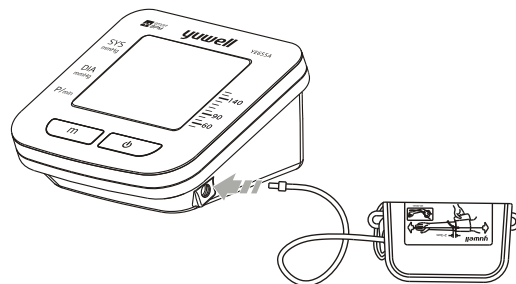

Using method of cuff

Place the cuff on table with the stick down. Make the cuff pass through the metal ring, the stick should be showing towards outside.

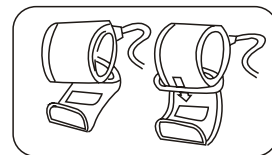

Using method of cuff

- ▶ Wind the cuff around the upper arm. (as shown

In the picture) Keep the lower edge of the cuff at the position above 2-3cm to the elbow joint and keep the air inlet which insert to the cuff at the inner side of arm.

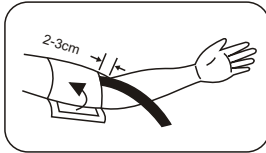
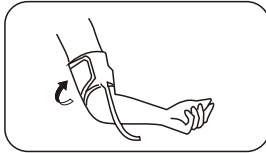

- ▶ Stick the cuff tightly.

⚠ Note: The cuff should be wearing comfortably, avoiding too tight or loose.

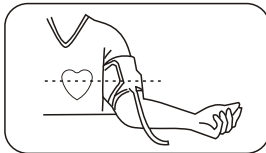

- ▶ Sit straight and flat the arm on table with palm up, also keep the center of cuff and heart at the same level. Also please ensure the air tube not twisted.

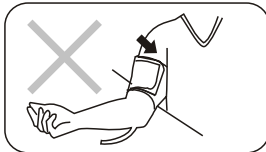

Measuring posture

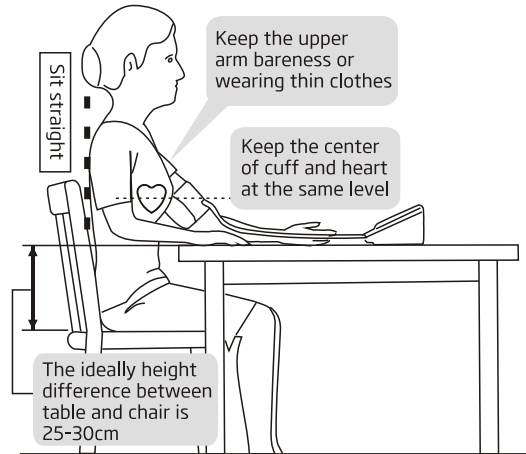

Wrong measurement postures

- ▶ Do not bend down or body bend forward.
- ▶ Do not sit with legs crossed.
- ▶ Do not sit on a sofa.(Belly pressure may increase the blood pressure)
- ▶ Do not put the arm on the low table.(May increase the blood pressure)



Start measuring

Don't eat, smoke, drink, take bath or do any high impact sport within half an hour before measuring. Measurements shall be taken at the same time every day.

Sit still for 5 minutes before the measurement

All icons on screen appear for 1 sec after pressing the "  "button, then disappear. After that the deflation icon flickers which means the system is in zero testing. Several seconds later the inflation icon flashes which means the zero testing is finished. Then inflation starts.

Full screen display state

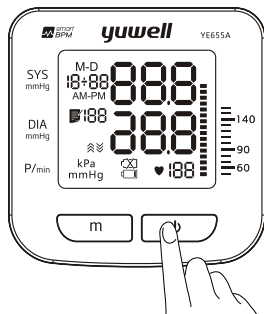

Start measuring

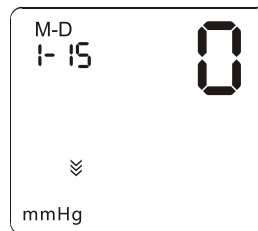

The zeroing state

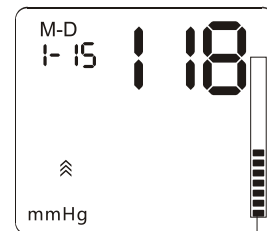

Increase with the pressure
The inflation state

- ▶ The monitor starts measuring automatically after inflation finished, and the measuring icon "  " starts to flicker, pressure release value starts to decrease gradually. Please maintain the position during the measurement and don't speak or move body or hand.

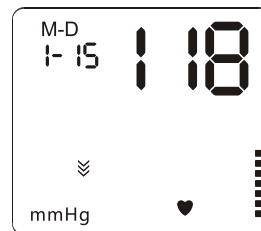

The measuring state

Start measuring

2. Measurement finished

After measurement, the monitor will show the SYS, DIA and pulse rate, then inflate the air automatically.

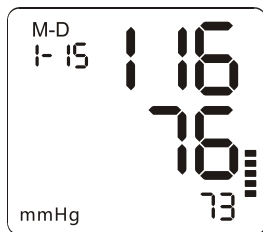

mmHg display

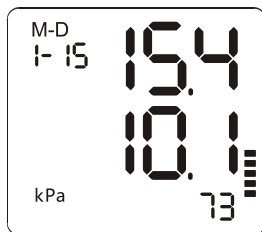

kPa display

3. Take off the cuff

4. Shut down

Press the "  "button to shut down. Also it will power off automatically in 30 seconds without any operation.

Blood pressure range indicator

- ▶ If the SYS is higher than 140mmHg or DIA higher than 90mmHg means having high blood pressure. Please contact with doctor for advice.
- ▶ Also the Blood pressure range indicator can show the blood pressure intuitively.

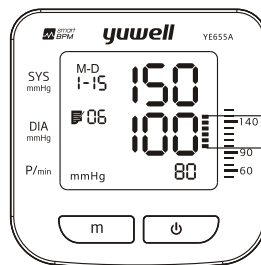

Higher than 140mmHg
Higher than 90mmHg



Tips!

- ▶ The time interval between two measurements should be at least 2~3 minutes or longer.
- ▶ Estimate the blood pressure condition according to the BP classification table, and consult the doctor.

Tips!



The monitor will store the measurement data automatically (including time, date, blood pressure and pulse), and the upper limit of records is 74. Press the "  " button to check the records.

Emergency stop during measurement

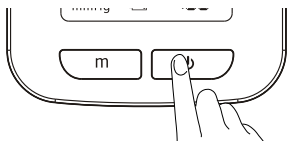
If the measurement need stoping for uncomfartableness or other reasons, please press the "  " button, the measurement will stop immediatly and air releases fast. Take off the cuff manually if the "  "button is not working.



⚠ Warning: Upper limit pressure of air inflation is 290mmHg/38.7kPa. Don't keep the inflated state for a long time to avoid damage.

1. Press the "  " button for the records.
 - A. Press the "  " button to show the average value of the latest 3 times measurement.
 - B. Reprress the "  "button to display the 1st group of memory, the serial number is displayed as "1" to "74". "1" is the latest group and the "74" is the earliest one.

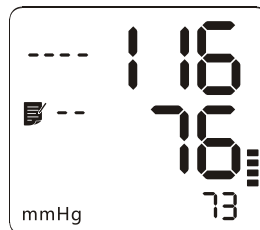

The average value

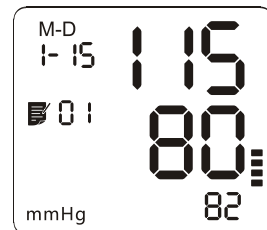



The 1st group of memory

Tips!

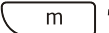

The 74th data may be replaced by the 73th when the memory capacity is full.

C. Read the recorded data by pressing the "  " button as the sequence: "1", "2" "74"(max). Then return to the 1st.

Holding the "  " button to search the data quickly.

D. Press the "  " button to shut off the monitor.

2. Delete the recorded data

Press the both "  " and "  " button until the display shown as the following picture, which means the recorded data is cleared.





Press the "  " button to turn off the monitor after deleting.

 **Note:** This operation will delete all the recorded data.

This function is mainly for professional personnel to enter the static mode to test the monitor through standard pressure gauge.

 **Warning:** Normal users don't need to know this function and also do not operate. The company will not take any responsibility for damage caused by this operation.



System restores

Press the "  " button after battery installation, then the screen will show the "  " icon, which means the system is in restore testing. Several seconds later, the "  " icon disappears and the air pump starts inflating at the same time, which indicates the test ended. Then press the "  " button to stop inflating and take out the batteries to enter the next step.

 **Note:** It must restore the system before entering the static mode, otherwise it may cause inaccurate results.

Static mode

Entering the static mode

Press the "  " button and hold, meanwhile install the batteries. Hold on for about 3 seconds then release the "  " button. Then screen will show the pressure value "  ", the date and time. Now the system has restored and entered the static mode. Now can take the static test.

Tips!

- ▶ After entering the static mode, if the screen still doesn't show "  ", please operate again as the System restore. Please contact with the local distributor if it still does not work.
- ▶ The monitor will automatically power off if there is no operation in 4 minutes.

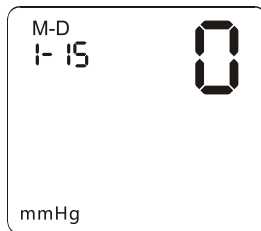

The static mode

Common questions of blood pressure measurement

1. What is blood pressure?

Blood pressure is the force exerted by blood against the walls of the arteries. Systolic pressure occurs when the heart contracts. Diastolic pressure occurs when the heart expands. Blood pressure is measured in millimetres of mercury (mmHg). One's natural blood pressure is represented by the fundamental pressure, which is measured first thing in the morning while one is still at rest and before eating.

2. What is Hypertension and how is it controlled?

Hypertension, an abnormally high arterial blood pressure, if left unattended can cause many health problems including stroke and heart attack. Hypertension can be controlled by altering lifestyle, avoiding stress, and with medication under a doctor's supervision.

To prevent Hypertension or keep it under control: Do not smoke, exercise regularly, reduce salt and fat intake, have regular physical checkups, maintain proper weight.

Common questions of blood pressure measurement

3. Why measure Blood Pressure at home?

Blood pressure measured at a clinic or doctor's office may cause apprehension and can produce an elevated reading, 25~30 mmHg higher than that measured at home. Home measurement reduces the effects of outside influences on blood pressure readings, supplements the doctor's readings and provides a more accurate, complete blood pressure history.

4. WHO Blood Pressure Classification?

Standards to assess high blood pressure, without regard to age, have been established by the world Health Organization (WHO), as shown below:

Range	Systolic pressure	Diastolic pressure	Counter-measures
Hypotension	$\leq 13.3/100$	$\leq 8.0/60$	Consult dr.
Ortho-arteriotony	13.3/100~18.7/140	8.0/60~12.0/90	Self check
Mild hypertension	18.7/140~21.3/160	12.0/90~13.3/100	Consult dr.
Medium hypertension	21.3/160~24.0/180	13.3/100~14.7/110	Consult dr.
Severe hypertension	$\geq 24.0/180$	$\geq 14.7/110$	Danger! Go to hospital as soon as possible

Common questions of blood pressure measurement

 **Note:** There is no definition about hypopiesia, and generally SYS(systolic pressure) less than 100mmHg is called hypopiesia.

5. Blood pressure variations?

An individual's blood pressure varies greatly on a daily and seasonal basis. It may vary by 30 to 50 mmHg due to various conditions during the day. In hypertensive individuals variations are even more pronounced. Normally, the blood pressure rises while at work or play and falls to its lowest levels during sleep. So do not be overly concerned by the results of one measurement.

Take measurements at the same time every day using the procedure described in this manual to get to know your normal blood pressure. Regular readings give a more comprehensive blood pressure history. Be sure to note date and time when recording your blood pressure. Consult doctor to interpret the blood pressure data.

Common questions of blood pressure measurement



6. When is the best time to measure blood pressure?

- ▶ After urination, before breakfast in the morning.
- ▶ Before sleeping at night.
- ▶ Before taking medicine.
- ▶ Please keep a stable body state and mind every time measuring. We suggest taking measurements at a same time every day.

Common fault and trouble shooting

Common fault	Solutions
It doesn't work after pressing the " "button with batteries installation	Check the batteries are installed correctly
	Replace new batteries
Multiple occurrences of measuring failure, or measured value is low (or high)	Check the connection and winding of cuff
	Check if the cuff winded too tight or too loose. Take off your clothes if rolled too tight
	Please ensure a quiet, relaxed body state o. Deep breathing to relax yourself before measurement
The monitor is in good condition, but the each measuring result are different	Please read the "blood pressure variations"carefully
The value is different from that measured at a clinic or doctor's office	Write down the value every day, and consult a doctor
Pump works, but the pressure doesn't rise	Check whether the cuff has connected well

The table below shows the possible fault displaying icon, possible reason, and solutions.

Wrong indication	Fault cause	Solution
Err4	Unable to measure pressure	Fasten cuff correctly before measurement
Err5	Pressurizing error	Check if there is air leakage from the cuff
Err6	Pressurizing error caused by arm or body motion	Keep arm and body still and measure again
Err7	Cuff is too loose or fall off	Fasten cuff tightly
Err8	Pressure exceeds the maximum value (290mmHg)	Measure again please
Showing low voltage icon "  "	Battery is low	Replace new batteries
Showing the "  "icon	Battery is running out	Replace new batteries

 **Warning:** If the situations cannot be solved or unexpected problem happens, please consult the local distributor.

Please observe the following items to protect the device and ensure the accuracy of measurement.

- ❗ Please store the monitor and accessories properly after use.
 - ⊘ Do not place the monitor and accessories in high temperature, moisture, dust, or exposure to sunshine.
 - ❗ The cuff contains an airbag inside, please care in applications, do not fold, pull or twist it.
 - ⊘ Do not disassemble or repair the device without authorization.
 - ⊘ Do not replace the parts without authorization.
 - ❗ Please clean the monitor with soft dry cloth. If it's necessary, please use wiped soft cloth with water or neutral detergent before cleaning by soft dry cloth.
- Using absorbent cotton to wipe gently with rubbing alcohol, disinfection of the machine when it necessary. Do not use detergent to clean.
- ⊘ Do not let water seep into the device.

Tips!

We advice to calibrate the monitor according to local laws and regulations.

1. Features

- ▶ Large-scale backlight LCD
- ▶ 74 groups of memory
- ▶ Average value display of three times measurement

▶ Intelligent pressurized

▶ Time and date display

2. Technical parameters

▶ Displaying: LCD digital display

▶ Measuring method: oscillation mensuration

▶ Measuring range:

Systolic pressure: 60-230mmHg (8.0-30.7kPa)

Diastolic pressure: 40-130mmHg (5.3-17.3kPa)

▶ Pulse rate: 40-200 time/min

▶ Precision:

Pressure: within 3mmHg(0.4kPa)

Pulse rate: within 5% of reading value

▶ Working system: Intermittent

▶ Electric classification: Class II, type BF application part

▶ Pressure sensor: Semiconductor pressure sensor

▶ Pressurization: Automatic pressurize

Features and technical parameters

- ▶ Depressurization: Automatic air releasing
- ▶ Power supply: 4 AA batteries or 6V/ 600mA DC power
- ▶ Maximum battery life: 300 times
- ▶ Suitable upper-arm circumference: 22-32cm
- ▶ Dimension: 107x106x63(mm)
- ▶ Operation and storage conditions:
 - Working temperature: +5°C~+40°C
 - Relative humidity: 15%~80%
 - Working atmosphere pressure: 80kPa~105kPa
 - Transport and storage temperature: -20°C~+55°C
 - Transport and storage relative humidity:15%~80%, no condensation
 - Transportation and storage atmosphere pressure: 80kPa ~ 105kPa
 - Operation environment:
 - Avoid electromagnetic interference, violent shock and noise environment.
 - Radio frequency interference

Features and technical parameters

There is the potential risk of radio frequency interference between the device and other devices. If there is, please find out the problems and take the following measures:

- (1) Turn off the device, and turn on again,
- (2) Change the direction of the device,
- (3) Keep the product away from the interferential devices.