

## Operating and Installation Instructions Microwave Oven



To prevent accidents and machine damage, read these instructions **before** installation or use.

## **PRECAUTIONS TO AVOID POSSIBLE EXPOSURE TO EXCESSIVE MICROWAVE ENERGY**

---

### **PRECAUTIONS TO AVOID POSSIBLE EXPOSURE TO EXCESSIVE MICROWAVE ENERGY**

- (a) Do not attempt to operate this oven with the door open since open-door operation can result in harmful exposure to microwave energy. It is important not to defeat or tamper with the safety interlocks.
- (b) Do not place any object between the oven front face and the door or allow soil or cleaner residue to accumulate on sealing surfaces.
- (c) Do not operate the oven if it is damaged. It is particularly important that the oven door close properly and that there is no damage to the: (1) Door (bent), (2) hinges and latches (broken or loosened), (3) door seals and sealing surfaces.
- (d) The oven should not be adjusted or repaired by anyone except properly qualified service personnel.

<b>PRECAUTIONS TO AVOID POSSIBLE EXPOSURE TO EXCESSIVE MICROWAVE ENERGY</b> .....	2
<b>IMPORTANT SAFETY INSTRUCTIONS</b> .....	6
<b>Before using for the first time</b> .....	18
<b>Installation</b> .....	19
Installation dimensions .....	19
Installation in a tall or base cabinet .....	19
Side view .....	20
Connections and ventilation .....	21
Installing the microwave oven .....	22
Electrical connection .....	23
<b>Caring for the environment</b> .....	25
<b>Overview</b> .....	26
<b>Control panel</b> .....	27
On/Off button .....	28
Display .....	28
Sensor buttons .....	28
Symbols .....	30
<b>Using the appliance</b> .....	31
Selecting a menu option .....	31
Changing a setting in a list .....	31
Changing the setting with a segment bar .....	31
Selecting an operating mode or function .....	31
Entering numbers .....	32
<b>Microwave operation</b> .....	33
How it works .....	33
Suitable dishware .....	33
Suitable dishware .....	34
Unsuitable dishware .....	35
Testing dishware .....	36
Cover .....	36
<b>Before first use</b> .....	37
Basic settings .....	37

# Contents

---

<b>Settings</b> .....	38
Settings overview .....	38
Accessing the “Settings” menu.....	39
Language  .....	39
Time.....	39
Volume.....	39
Units .....	40
Keeping Warm.....	40
Quick MW.....	40
Popcorn.....	40
Oven compartment query .....	40
Safety .....	41
Showroom program.....	41
Factory default.....	41
<b>Operation</b> .....	42
Tips for cooking with the microwave .....	42
Using the turntable.....	42
Changing values and settings for a cooking process .....	43
Changing the microwave power level .....	43
Setting additional durations .....	43
Changing set cooking durations .....	44
Deleting the set cooking durations.....	44
Interrupting and resuming a cooking process.....	45
Canceling a cooking process.....	45
<b>Timer</b> .....	46
<b>Quick MW and Popcorn</b> .....	47
<b>Automatic Programs</b> .....	49
Overview of automatic programs .....	49
Using automatic programs .....	49
Using the Bacon automatic program .....	49
Using the Potatoes automatic program.....	50
Using the Fish Fillet automatic program.....	50
Using the Vegetables automatic program .....	50
Using the Rice automatic program.....	51

---

Recipes.....	51
Potatoes in a curry sauce.....	52
Chicken breast in mustard sauce.....	52
Salmon in white wine sauce.....	53
Minestrone.....	53
Carrots in a chervil cream sauce.....	54
Red berry fruit compote.....	54
Meatballs.....	55
White cabbage stew.....	55
<b>Additional applications</b> .....	56
Defrost.....	56
Reheat.....	58
Cooking.....	61
Canning.....	62
<b>Cleaning and care</b> .....	64
Unsuitable cleaning agents.....	65
Removing soiling.....	65
<b>Frequently Asked Questions</b> .....	67
<b>Customer Service</b> .....	70
Contact in the event of a fault.....	70
Appliance warranty and product registration.....	70

# IMPORTANT SAFETY INSTRUCTIONS

---

When using the appliance, follow basic safety precautions, including the following:

Read all instructions before installation and use of the oven to prevent accidents and machine damage.

**WARNING - To reduce the risk of burns, electric shock, fire, injury to persons, or exposure to excessive microwave energy:**

This appliance complies with current safety requirements. Improper use of the appliance can lead to personal injury and material damage.

Read all instructions before installing or using the oven for the first time. Only use the appliance for its intended purpose.

Keep these operating instructions in a safe place and pass them on to any future user.

Read and follow the specific “PRECAUTIONS TO AVOID POSSIBLE EXPOSURE TO EXCESSIVE MICROWAVE ENERGY” found at the beginning of this manual.

Only use the appliance for its intended purpose. Install or locate this appliance only in accordance with the provided installation instructions and all local codes.

## Appropriate use

- ▶ This microwave oven is intended for domestic use and use in other similar environments.
  - ▶ This microwave oven must not be used at altitudes exceeding 6562 ft. (2000 m).
  - ▶ The microwave oven is not intended for outdoor use.
  - ▶ The microwave oven is intended to cook, defrost, reheat and can food in domestic settings only.
- All other types of use are not permitted.

# IMPORTANT SAFETY INSTRUCTIONS

---

- ▶ Risk of fire due to flammable materials.

If flammable items are dried in the microwave oven, the moisture in the items will evaporate. This could cause the materials to dry out and possibly self-ignite.

Never use the microwave oven to store or dry items which could ignite easily.

- ▶ This microwave oven can only be used by people with reduced physical, sensory, or mental capabilities or lack of experience and knowledge if they are supervised while using it.

They may only use it unsupervised if they have been shown how to do so in a safe manner. They must be able to understand and recognize the possible dangers caused by incorrect operation.

- ▶ The oven compartment is equipped with special bulbs to cope with particular conditions (e.g., temperature, moisture, chemical resistance, abrasion resistance, and vibration). These special bulbs must only be used for the purpose for which they are intended. They are not suitable for room lighting. Replacement bulbs should only be installed by a Miele authorized technician or by Miele Customer Service.

## **Safety with children**

- ▶ Children should be supervised in the vicinity of the microwave oven. Never allow children to play with the microwave oven.

- ▶ Burn Hazard - Do not allow children to use the microwave oven.

- ▶ Risk of suffocation from packaging material. While playing, children may become entangled in packaging material (such as plastic wrapping) or pull it over their head, presenting the risk of suffocation.

Keep packaging material away from children.

## IMPORTANT SAFETY INSTRUCTIONS

---

▶ Risk of injury caused by hot surfaces. Children's skin is far more sensitive to high temperatures than that of adults. External parts of the microwave oven such as the control panel and the vent become quite hot.

Do not let children touch the microwave oven when it is in operation.

▶ Risk of injury from the open door. The oven door can support a maximum weight of 17.5 lbs (8 kg). Children could injure themselves on an open door.

Do not let children sit on the door, lean against it, or swing on it.

### Technical safety

▶ This appliance must be installed and connected in compliance with the installation instructions.

▶ Unauthorized installation, maintenance, and repairs can cause considerable danger for the user. Installation, maintenance, and repairs should only be carried out by a Miele authorized technician.

▶ Maintenance by the user: Never repair or replace any part of the appliance unless the instructions specifically recommend doing so. Service work should only be performed by a qualified technician.

▶ Damage to the microwave oven can compromise your safety. Check the microwave oven for visible signs of damage. Do not use a damaged microwave oven.

## IMPORTANT SAFETY INSTRUCTIONS

---

▶ Temporary or permanent operation on an autonomous power supply system or a power supply system that is not synchronized with the grid power supply (e.g., island networks, back-up systems) is possible. A prerequisite for operation is that the power supply system complies with the specifications of EN 50160 or an equivalent standard.

The function and operation of the protective measures provided in the domestic electrical installation and in this Miele product must also be maintained in isolated operation or in operation that is not synchronized with the grid power supply, or these measures must be replaced by equivalent measures in the installation. As described, for example, in the current version of VDE-AR-E 2510-2.

▶ Operating a damaged microwave oven can result in microwave leakage and present a hazard to the user. Do not use the microwave oven if:

- The door is warped.
- The door hinges are loose.
- Holes or cracks are visible in the casing, the door, or the oven compartment walls.

▶ The electrical safety of this appliance can only be guaranteed when correctly grounded. It is essential that this basic safety requirement is fulfilled. If in doubt, the electrical installation should be checked by a qualified electrician.

▶ Proper installation: Make sure that your appliance has been installed correctly and that it has been grounded by a qualified technician.

▶ The connection data (voltage and frequency) on the data plate of the microwave oven must match the domestic electrical supply in order to avoid the risk of damage to the microwave oven. Compare this before connecting the appliance to the domestic electrical supply. If in any doubt, consult a qualified electrician.

## IMPORTANT SAFETY INSTRUCTIONS

---

- ▶ Power bars and extension cords do not guarantee the required safety of the appliance. Do not use these to connect the microwave oven to the power supply.
- ▶ For safety reasons, only use the microwave oven when it has been fully installed.
- ▶ This appliance must not be used in a non-stationary location (e.g., on a ship).
- ▶ Risk of injury due to electric shock. Any contact with live connections or tampering with the electrical or mechanical components of the microwave oven will endanger your safety and may lead to appliance malfunctions.  
Do not open the microwave oven housing under any circumstances.
- ▶ While the appliance is under warranty, repairs should only be undertaken by a service technician authorized by Miele Customer Service. Otherwise the warranty will be invalidated.
- ▶ Miele can only guarantee the safety of the appliance when original Miele parts are used. Faulty components must only be replaced with genuine Miele parts.
- ▶ If the power cord is damaged, it must be replaced with a special power cord by a Miele authorized technician (see “Installation – Electrical connection”).
- ▶ During installation, maintenance, and repair work, the microwave oven must be completely disconnected from the power supply. To ensure this:
  - The circuit breakers have been switched off, or
  - the fuses of the electrical installation have been completely removed, or
  - the plug (if present) is removed from the outlet. To do this, pull the plug not the cord.

## IMPORTANT SAFETY INSTRUCTIONS

---

- ▶ The microwave oven requires a sufficient supply of cool air for efficient operation. Make sure that the supply of cool air is not hindered in any way (e.g., by installing heat insulation strips in the cabinet niche). In addition, the required supply of cool air must not be excessively heated by other heat sources.
- ▶ If the microwave oven is built in behind a cabinet door front, do not close the cabinet door while the microwave oven is in use. Heat and moisture can build up behind the cabinet door when closed. This can result in damage to the microwave oven, cabinet niche, and floor. Leave the cabinet door front open until the microwave oven has cooled down completely.

### **Correct use**

- ▶ Do not let food sit in the oven for an extended period of time before or after cooking. Doing so can result in food poisoning or sickness.
- ▶ Smother the fire or flames, or use a dry chemical extinguishing agent or foam fire extinguisher.
- ▶ Never store flammable liquids and materials in, above or under the microwave oven.
- ▶ Do not obstruct the flow of combustion and ventilation air.
- ▶ This microwave oven must only be used for cooking food. Corrosive chemicals and vapors as well as fumes, vapors or heat given off by glues, plastics or flammable liquids and materials could be hazardous. Do not use it as a dryer, kiln, dehumidifier, etc.
- ▶ To avoid fueling any flames, do not open the microwave oven door if smoke occurs inside the appliance. Interrupt the process by turning the appliance off and disconnecting it from the power. Do not open the door until the smoke has dissipated.
- ▶ Due to the high temperatures radiated, objects left near the microwave oven could catch fire. Do not use the microwave oven to heat up the room.

## IMPORTANT SAFETY INSTRUCTIONS

---

▶ Oils and fats are a fire hazard if allowed to overheat. Never leave the microwave oven unattended when cooking with oil or fats. Never attempt to put out oil or fat fires with water. Turn the microwave oven off and extinguish the flames by leaving the door closed.

▶ Fire hazard. If using alcohol in your recipes, please be aware that high temperatures can cause the alcohol to evaporate. The vapor can catch fire on hot surfaces.

Do not heat undiluted alcohol in the appliance.

▶ Food which is stored in the oven interior or left there to be kept warm can dry out, and the moisture released can lead to corrosion damage in the microwave oven. The control panel, countertop and surrounding cabinetry can also be damaged.

Always cover food that is left in the appliance.

▶ The microwave oven is not suitable for cleaning or disinfecting items. Items can get extremely hot. There is a risk of burning when items are removed from the microwave oven.

▶ Always ensure that food is sufficiently heated.

Many factors will affect the overall cooking time, including the type, amount and nature of the food, its initial temperature, and changes to the recipe. Some foods may contain microorganisms which are only destroyed by thorough cooking. Therefore, when cooking or reheating food, it is particularly important that food is heated at adequate temperatures for a sufficient amount of time. When in doubt, select a longer cooking or reheating time.

▶ It is important that the temperature in the food being cooked is evenly distributed and sufficiently high.

You can ensure this by stirring or turning the food, and observing a sufficiently long standing time (see charts), which should be added to the time needed for reheating, defrosting, or cooking.

During the standing time, the temperature is distributed evenly in the food.

## IMPORTANT SAFETY INSTRUCTIONS

---

▶ Always remember that times for cooking, reheating and defrosting in a microwave oven are usually considerably shorter than in the case of traditional methods of food preparation. Excessively long cooking times can lead to food drying out and burning, or may even cause it to catch fire.

Do not dry bread, rolls, flowers, herbs, etc., in the microwave oven as these could also catch fire.

▶ When heating food, and in particular liquids, using microwave power, the boiling point may be reached without the typical bubbles being produced. The liquid does not boil evenly throughout. This boiling delay can result in the liquid boiling over explosively. Take care when taking the container out of the microwave oven, as the hot liquid can cause severe scalding. Under certain circumstances, the pressure can be so high that the door opens automatically. Stir liquids well before heating or cooking. After heating, wait at least 20 seconds before removing the container from the microwave oven. In addition, you can place a glass rod or similar item, if available, in the container during the heating process.

▶ Risk of injury caused by hot food. When you heat food up, the heat is created directly in the food itself. For this reason, the dishware will remain cooler than the food (except when you use ovenproof stoneware). The dishware is only warmed by the heat of the food.

Before serving, always check the temperature of the actual food itself after taking it out of the oven. The temperature of the container is not an indication of the temperature of the food or liquid in it. **This is particularly important when preparing food for babies, children, and the elderly or infirm.** After heating food, especially food for babies and small children, stir the food or shake the container and check that the temperature does not pose any danger of burning. Double check after it has been left to stand.

## IMPORTANT SAFETY INSTRUCTIONS

---

- ▶ Risk of injury from increased pressure in sealed containers or bottles. Pressure can build up when reheating food or drinks in sealed containers or bottles, which can cause them to explode. Never cook or reheat food or liquids in sealed containers or bottles. Open containers beforehand and with baby bottles, the screw top and nipple must be removed.
- ▶ If you cook eggs without their shells, the yolks could explode due to the resulting pressure. Prick the yolk several times before cooking to avoid this.
- ▶ Eggs heated in their shell can burst, even after they have been removed from the microwave oven. Eggs can only be cooked in their shells in a specially designed egg-boiling device. Do not reheat hard-boiled eggs in the microwave oven.
- ▶ Food with a thick skin or peel, such as tomatoes, sausage, potatoes, and eggplant can burst when heated or cooked. Pierce or score the skin of these foods several times to allow steam to escape.
- ▶ Do not use a thermometer containing mercury or liquid as these are not suitable for use with very high temperatures and break very easily. To check food temperature, first interrupt the cooking process. Only use a thermometer specifically approved for food use to measure the temperature of the food.
- ▶ Cushions or pads filled with cherry kernels, gel, etc., such as those used in aromatherapy, can ignite when heated, even after they have been removed from the microwave oven. Do not heat these up in the microwave oven.

## IMPORTANT SAFETY INSTRUCTIONS

---

▶ Moisture can collect in the hollow spaces on dishware and lids with hollow handles or knobs. When the moisture evaporates, pressure can build up and the item can explode. If the hollow recess is sufficiently ventilated, the item can be used.

Do not use dishware with hollow knobs or handles.

▶ Non-microwave-safe plastic dishes can suffer damage or damage the microwave oven.

Do not use any containers or cutlery made from or containing metal, aluminum foil, lead crystal glassware, temperature-sensitive plastics, wooden utensils or cutlery, metal clips, or plastic or paper-covered wire ties. Do not use bowls with milled rims, or plastic pots with the foil lid only partially removed (see the requirements specified for dishware in the section on microwave operation).

▶ Fire hazard due to containers made of flammable materials.

Plastic disposable containers must meet the requirements specified for dishware in the section on microwave operation.

Do not leave the microwave oven unattended when heating or cooking food in disposable containers made of plastic, paper, or other flammable materials.

▶ Heat-retaining bags usually contain a thin layer of aluminum foil that reflects microwave radiation. As a result, the paper surrounding the aluminum foil can become so hot that it combusts.

Do not use heat-retaining packaging, such as bags for roasted chicken, for warming food.

▶ If the microwave oven is used without food or the food is loaded incorrectly, the appliance can become damaged.

Do not use the microwave oven to preheat dishware or to dry herbs.

▶ Risk of injury from the open door. You could bang into the open door. Do not leave the door open unnecessarily.

## IMPORTANT SAFETY INSTRUCTIONS

---

▶ The door can support a maximum load of 17.5 lbs (8 kg). Do not lean or sit on an open door, or place heavy items on it. Make sure that nothing gets trapped between the door and the oven compartment. This could damage the microwave oven.

**The following applies to stainless steel surfaces:**

▶ Adhesives will damage the coated stainless steel surface and cause it to lose its dirt-repellent protective coating. Do not use sticky notes, adhesive tape, or other types of adhesive on the stainless steel surface.

▶ Magnets can cause scratches. Do not use the stainless steel surface as a magnetic notice board.

# IMPORTANT SAFETY INSTRUCTIONS

---

## Cleaning and care

- ▶ Risk of injury due to electric shock. The steam from a steam cleaning appliance could reach live electrical components and cause a short circuit. Never use a steam cleaner for cleaning.
- ▶ Risk of burns. The appliance interior can get hot during use. Clean the appliance interior and accessories as soon as they have cooled down. Waiting too long can make cleaning unnecessarily difficult and, in extreme cases, impossible.  
Risk of fire. Under certain conditions, strong grease and gunk buildup can damage the appliance and even be dangerous. Follow the instructions on cleaning in "Cleaning and care".
- ▶ Only clean parts listed in these operating and installation instructions.
- ▶ Scratches on the door glass can cause the glass to break. Do not use abrasive cleaners, hard sponges, brushes, or sharp metal tools to clean the door glass.
- ▶ Try to prevent the interior walls being splashed with food containing salt. If this does happen, wipe it away thoroughly to avoid corrosion to stainless steel surfaces inside the oven compartment.
- ▶ In warm, moist environments, there is a higher probability of pest infestations. Ensure the microwave oven and the area surrounding it are always kept clean.  
Damage caused by pests is not covered by the warranty.

## Accessories

- ▶ Only use original Miele accessories. Using parts or accessories from other manufacturers will invalidate the warranty, and Miele cannot accept liability.

**KEEP THE OPERATING AND INSTALLATION INSTRUCTIONS IN A SAFE PLACE AND REVIEW THEM PERIODICALLY.**

## Before using for the first time

It is important to allow the temperatures of the microwave oven and the room to equalize. Otherwise, the appliance electronics may not function correctly.

After transportation, let the unpacked microwave oven stand for approx. 2 hours at room temperature before using it.

 Risk of suffocation from packaging material

While playing, children may become entangled in packaging material (such as plastic wrapping) or pull it over their head, presenting the risk of suffocation.

Keep packaging material away from children.

- Remove all packaging material when unpacking the microwave oven.

There is a cover protecting the microwave outlet on the ceiling of the oven, which is susceptible to damage.

**Never** remove the cover from the microwave outlet.

- Check the microwave oven for any damage.

 Health risk posed by a faulty microwave oven

Operating a damaged microwave oven can result in microwave leakage and present a hazard to the user.

Do not use the microwave oven if:

- The door is warped.
- The door hinges are loose.
- Holes or cracks are visible in the casing, the door, or the oven compartment walls.

- Clean the oven compartment and all accessories with a soft sponge and warm water.

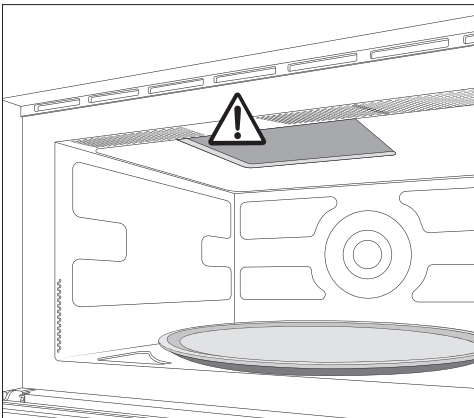

When installing the microwave oven, ensure that there is unhindered ventilation at the front of the appliance.

Do not block the ventilation slots with any objects.

## Installation dimensions

### Installation in a tall or base cabinet

Miele microwave ovens can be installed flush or proud. Discuss your requirements with your architect, kitchen designer, and installer.

More installation drawings are available on the Miele website.

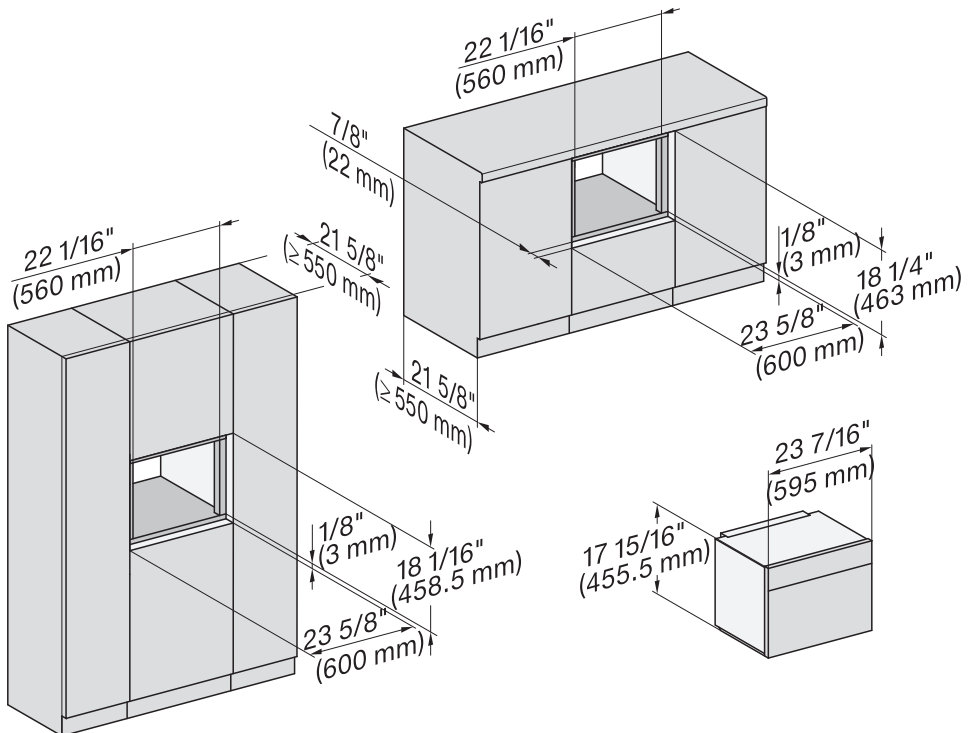

# Installation

## Side view

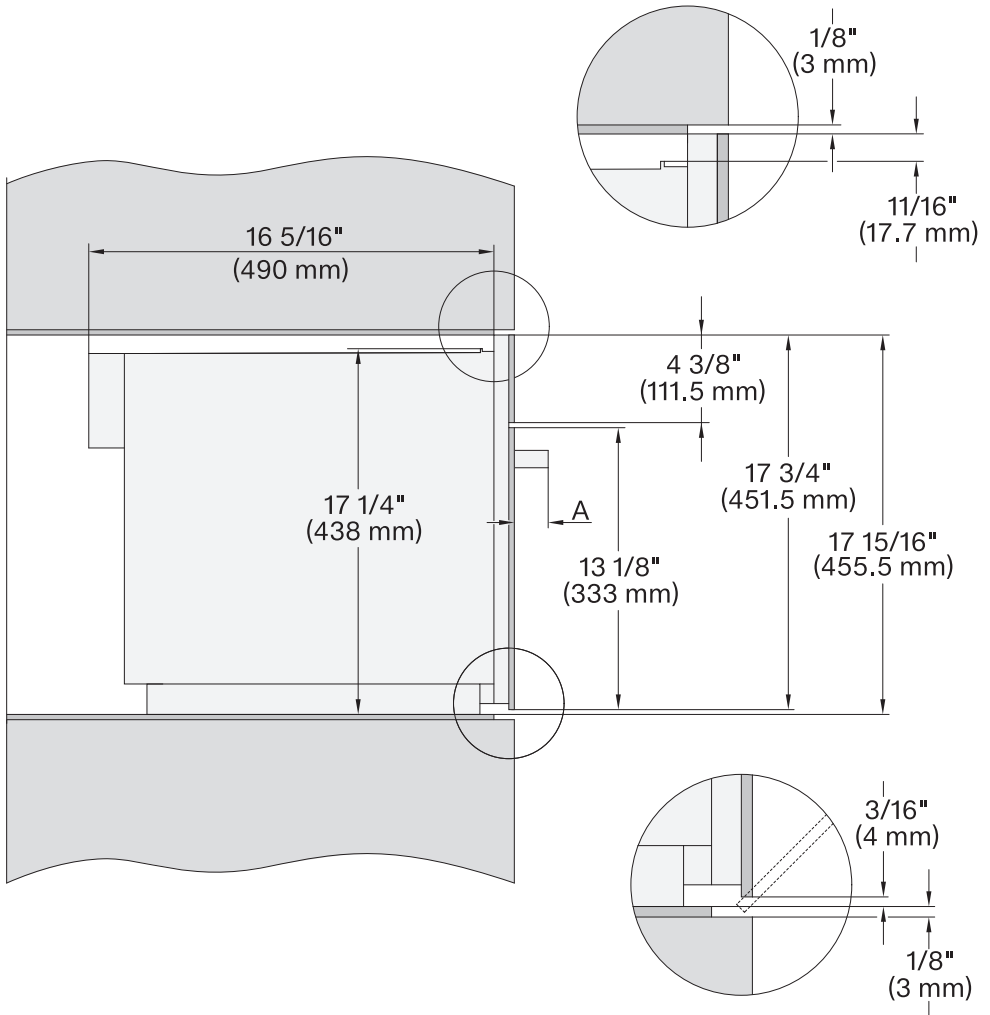

**A** M 72xx:  $1 \frac{7}{8}$ " (47 mm)

## Connections and ventilation

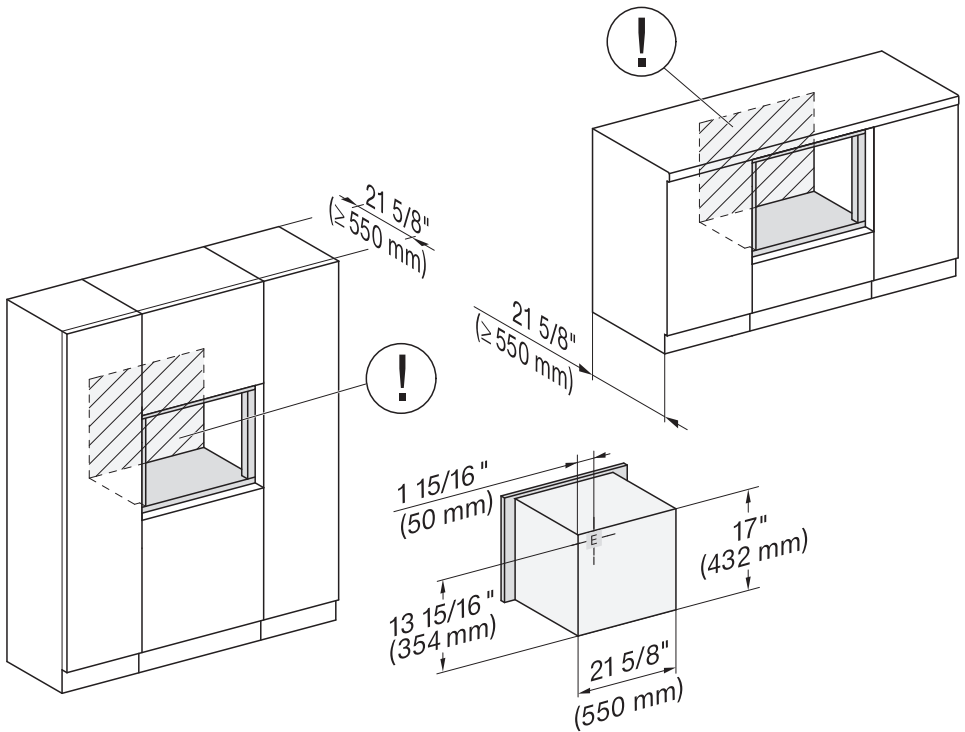

- ⓘ The outlet for the electrical connection should be accessible, e.g., in an adjacent kitchen cabinet. If the electrical connection is behind the microwave oven, the kitchen cabinet needs to be deeper than specified.

### E Electrical connection

# Installation

---

## Installing the microwave oven

For safety reasons, only use the microwave oven when it has been fully installed.

### Securing the microwave oven in the cabinet niche

- Connect the microwave oven to the power supply.

Do not carry the microwave oven by the door handle. This could damage the door.

Use the handles on each side of the housing to carry the appliance.

- Push the microwave oven into the cabinet niche and align it in the center of the cabinet niche. Pull the cable with the plug through the rear wall of the cabinet.
- Open the door.

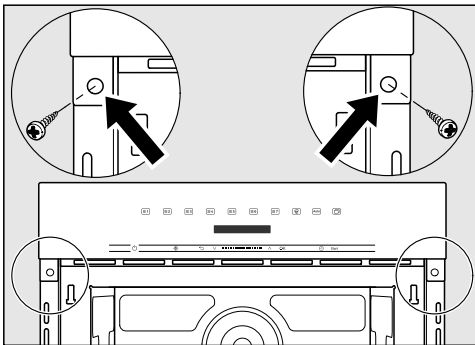

- Use the screws supplied to secure the microwave oven to the side walls of the cabinetry through the holes in the oven trim.

## Electrical connection

 Risk of injury due to electric shock.

During installation, maintenance, and repair work, the microwave oven must be completely disconnected from the power supply:

Disconnect the microwave oven from the power supply by tripping the breakers, or unplugging the power cord from the outlet. To do this, pull the plug not the cord.

 Risk of injury.

Installation, repairs, and other work by unqualified persons could be dangerous. Miele cannot be held liable for unauthorized work.

Installation, maintenance, and repairs must only be carried out by a Miele authorized technician.

The connection data (voltage, frequency and max. rated load) on the data plate of the microwave oven must match the power supply in order to avoid the risk of damage to the microwave oven.

The connection data can be found on the data plate, which is visible on the front frame or at the back of the microwave oven. Compare this before connecting the appliance to the power supply. If in any doubt, consult a qualified electrician.

For safety reasons, the microwave oven may only be used when it has been fully installed.

The power cord plug must be inserted into a suitable outlet that has been installed and grounded in compliance with all applicable local codes.

**WARNING: THIS APPLIANCE MUST BE GROUNDED**

**Installer: Please pass these instructions on to the customer.**

# Installation

 Risk of injury caused by a damaged microwave oven.  
Damage to the microwave oven can compromise your safety.  
Check the microwave oven for visible signs of damage. Do not use a damaged microwave oven.

The microwave oven is supplied with a plug for connection to a dedicated line and junction box.

Install the microwave oven so that the outlet is accessible. If the outlet is not accessible, make sure that a suitable means of disconnection is provided on site for each pole.

 Risk of fire by overheating.  
Installing the appliance with a power bar or an extension cord can overload the cords.  
Do not use power bars and extension cords to connect the microwave oven to the power supply.

If the power cord is damaged, it must be replaced with a special power cord of the same type (available from Miele). For safety reasons, the power cord must only be replaced by a Miele authorized technician.

The max. rated load and the fuse protection can be found in these operating and installation instructions or on the data plate. Compare this with the data of the domestic electrical supply. If in any doubt, consult a qualified electrician.

Temporary or permanent operation on an autonomous power supply system or a power supply system that is not synchronized with the grid power supply (e.g., island networks, back-up systems) is possible. A prerequisite for operation is that the power supply system complies with the specifications of EN 50160 or an equivalent standard. The function and operation of the protective measures provided in the domestic electrical installation and in this Miele product must also be maintained in isolated operation or in operation that is not synchronized with the grid power supply, or these measures must be replaced by equivalent measures in the installation. As described, for example, in the current version of VDE-AR-E 2510-2.

Do not connect the appliance to energy saving plugs or outlets. The reduction of power to the appliance caused by these devices will cause the appliance to run hot and may damage it and/or shorten its usable life.

## Electrical connection

The microwave oven is equipped with a 7 ft. (2.1 m) long power cord with a NEMA 5-15P molded plug for connection to a 120 V, 15 A, 60 Hz power supply.

**KEEP THE OPERATING AND INSTALLATION INSTRUCTIONS IN A SAFE PLACE.**

### Disposal of the packing material

The cardboard box and packing materials protect the appliance during shipping. They have been designed to be biodegradable and recyclable.

Ensure that any plastic wrappings, bags, etc. are disposed of safely and kept out of the reach of children.  
Danger of suffocation!

### Disposal of your old appliance

Electrical and electronic appliances contain valuable materials. They also contain certain substances, compounds and components which were essential for the proper functioning and safe use of the equipment. Handling these materials improperly by disposing of them in your household waste can be harmful to your health and the environment. Therefore, please do not dispose of your old appliance with regular household waste and follow local regulations on proper disposal.



Consult with local authorities, dealers or Miele in order to dispose of and recycle electrical and electronic appliances. Miele assumes no responsibility for deleting any personal data left on the appliance being disposed. Please ensure that your old appliance is kept away from children until removal. Observe safety requirements for appliances that may tip over or pose an entrapment hazard.

# Overview





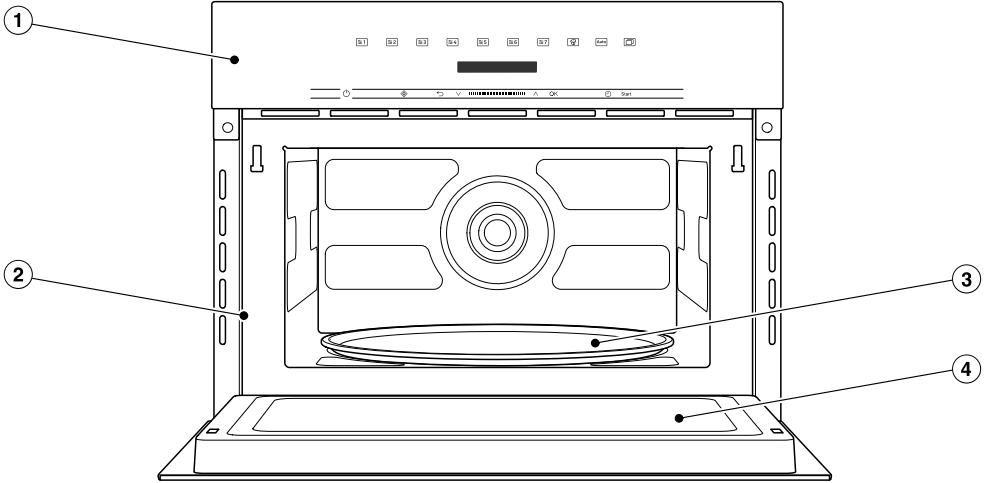

---

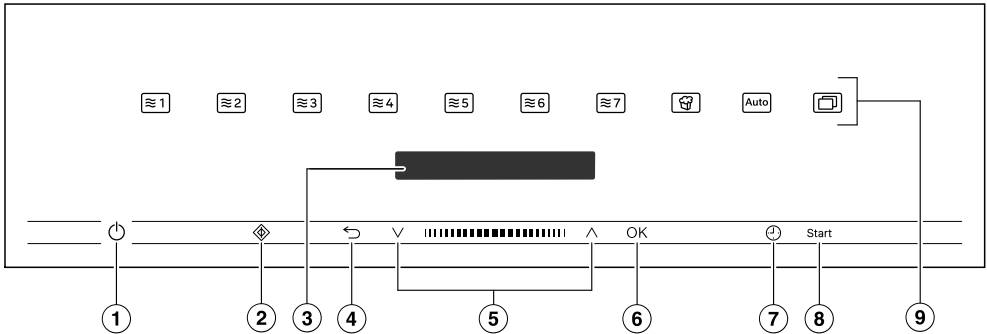
## Microwave oven



- ① Controls
- ② Front frame and data plate with model identifier and serial number  
Connection data (voltage/frequency/max. rated load): see back of the appliance
- ③ Turntable
- ④ Door



- ① Recessed  On/Off button  
For turning the microwave oven on and off
- ②  sensor button  
For starting the Quick MW function
- ③ Display  
For displaying the time of day and information on operation
- ④  sensor button  
For going back a step and for canceling a cooking program
- ⑤ Navigation area with  and  arrow buttons  
For scrolling through lists and for changing values
- ⑥ *OK* sensor button  
For accessing functions and saving settings
- ⑦  sensor button  
For setting a timer, the cooking duration, or the start or finish time for the cooking program
- ⑧ start sensor button  
For starting a cooking process
- ⑨ Sensor buttons  
For selecting operating modes, settings, and further applications

# Control panel

---

## On/Off button

The  On/Off button is recessed and reacts to touch.



Use this button to turn the microwave oven on and off.

## Display

The display is used for showing the time of day or information about operating modes, cooking durations, automatic programs, and settings.

After turning the microwave oven on with the  On/Off button, **Select Operating Mode** will appear in the main menu.

## Sensor buttons







The sensor buttons react to touch. Every tap of a sensor button is confirmed with an audible keypad tone. You can turn this keypad tone off using **More**  | **Settings**  | **Volume** | **Keypad tone**.

If the display is dark, you have to switch on the microwave oven before the sensor buttons react.





## Sensor controls above the display

Information on the functions and operating modes can be found under “Operation”, “Settings”, “Automatic programs”, and “Additional modes”.





## Operating mode/microwave power level

-  80 W
-  150 W
-  300 W
-  450 W
-  600 W
-  750 W
-  900 W

## Automatic program/mode/function

-  Popcorn  
For starting the Popcorn function
-  Automatic Programs  
For accessing various automatic programs
-  More  
For accessing further modes and settings
  - Defrost  
For selecting various food defrosting categories
  - Reheat  
For selecting various food reheating categories
  - Settings   
For customizing the settings by altering the defaults

## Sensor buttons under the display





Sensor button	Function
	<p>Use this sensor button to start the Quick MW function. The cooking process runs with maximum power level <math>\approx 7</math> (900 W) and a cooking duration of 1 minute (see section “Quick MW”). Touching the sensor button repeatedly increases the cooking duration in increments.</p> <p>This function can only be used when no other cooking processes are in use.</p>
	<p>Depending on which menu you are in, this sensor button will take you back a level or back to the main menu.</p> <p>If a cooking program is in progress at the same time, use this sensor button to cancel the program.</p>
	<p>In the navigation area, use the arrow buttons or the area between them to scroll up or down in the lists. The display shows the menu option that you want to select.</p> <p>You can change the values and settings using the arrow buttons or the area between them.</p>
OK	<p>As soon as you reach a confirmable value, message, or setting, the OK sensor button will light up orange.</p> <p>By selecting this sensor button you can access functions such as the timer, save changes to values or settings, or confirm instructions.</p>
	<p>You can use this sensor button to set a timer (e.g., when boiling eggs) at any point, even if a cooking program is in progress at the same time.</p> <p>You can also use this sensor button to set cooking durations.</p>
Start	<p>As soon as the microwave is ready for you to start a cooking process, this sensor control lights up green.</p>

# Control panel

---

## Symbols

The following symbols may appear on the display:

Symbol	Meaning
	This symbol indicates that there is additional information and advice about using the appliance. Select <i>OK</i> to confirm the information.
	Timer
	A check indicates the option which is currently selected.
	Some settings, e.g., display brightness and signal tone volume, are selected using a segment bar.
	The system lock prevents the microwave oven being switched on by mistake (see “Settings” – “Safety”).

Use the  $\wedge$  and  $\vee$  arrow buttons or the  area between them in the navigation area to use the microwave oven.

As soon as you reach a confirmable value, message, or setting, the *OK* sensor button will light up orange.

## Selecting a menu option

- Touch the  $\wedge$  or  $\vee$  arrow buttons or swipe to the right or left in the  area until you reach the desired menu option.

**Tip:** If you press and hold an arrow button, the list continues scrolling automatically until you release the arrow button.

- Confirm your selection with *OK*.

## Changing a setting in a list

A  $\checkmark$  check will appear beside the current setting.

- Touch the  $\wedge$  or  $\vee$  arrow buttons or swipe to the right or left in the  area until you reach the desired value or setting.
- Confirm with *OK*.

The setting is now saved. This will take you back to the previous menu.

## Changing the setting with a segment bar

Some settings are represented by a  bar made up of segments. If all of the segments are illuminated, the maximum value is selected.

If none of the segments are illuminated or if only one is, the minimum value is selected or the setting is turned off altogether (e.g., volume).

- Touch the  $\wedge$  or  $\vee$  arrow buttons or swipe to the right or left in the  area until you reach the desired setting.
- Confirm your selection with *OK*.

The setting is now saved. This will take you back to the previous menu.

## Selecting an operating mode or function

The sensor controls for the operating modes and functions (e.g., *More* ) are located above the display (see “Operation” and “Settings”).

- Touch the sensor control for the desired operating mode or function.

The sensor control on the control panel lights up orange.

- For operating modes and functions: set values such as the cooking duration or weight.
- Under *More* : scroll through the lists until you reach the desired menu option.
- Confirm with *OK*.

# Using the appliance

---

## Changing the operating mode

You can change to another operating mode or function during a cooking process.

The sensor control for the previously selected operating mode or function lights up orange.

- Touch the sensor control of the new operating mode or function.

The new operating mode will appear on the display with its corresponding recommended values.

The sensor control for the new operating mode lights up orange.

Under More , scroll through the lists until you reach the desired menu option.

## Entering numbers

Numbers that can be changed are highlighted.

- Touch the  $\wedge$  or  $\vee$  arrow buttons or swipe to the right or left in the  area until the desired number is highlighted.

**Tip:** If you press and hold an arrow button, the numbers continue scrolling automatically until you release the arrow button.

- Confirm with *OK*.

The changed number is now saved. This will take you back to the previous menu.

## How it works

The microwave oven contains a magnetron that converts electrical energy into electromagnetic waves (microwaves). These microwaves are distributed evenly throughout the oven compartment and are also reflected by the metal walls inside the oven.

The microwaves penetrate the food from all sides. Food consists of many molecules. When subjected to microwave energy, these molecules (particularly the water molecules) start to oscillate. This heats the food from the outside to the inside. The more water a food contains, the faster it is reheated or cooked.

## Advantages of the microwave oven

- Food can generally be cooked with little or no liquid or cooking oil.
- The times for defrosting, reheating, or cooking are shorter than with a cooktop or oven.
- Vitamins, minerals, natural color, and taste of the food are generally retained.

## Suitable dishware

In order for microwaves to reach the food, they must be able to penetrate the dishware being used. Microwaves can pass through porcelain, glass, cardboard, and plastics, but not metal. Therefore, do not use metal containers or dishware that contains metal. Metal reflects the microwaves which can create sparks and the microwaves are not absorbed by the metal.

 Danger of injury from increased pressure in sealed containers or bottles

Pressure can build up when reheating food or drinks in sealed containers or bottles, which can cause them to explode.

Never cook or reheat solid or liquid food in sealed containers or bottles.

Open containers beforehand and, with baby bottles, remove the screw top and teat.

 Risk of fire due to unsuitable dishware

Dishware that is not microwave-safe can be destroyed and may damage the microwave oven.

Only use microwave-safe dishware in the microwave oven.

The material and shape of dishware used affect reheating and cooking durations.

Heat distribution is more even in round and oval-shaped flat containers. Food is reheated more evenly in these containers than in square ones.

# Microwave operation

## Suitable dishware

 Fire hazard due to flammable materials

Disposable containers made out of plastic, paper, or other flammable materials can ignite, causing damage to the microwave oven.

Do not leave the microwave oven unattended when reheating or cooking food in disposable containers made of plastic, paper, or other flammable materials.

You can use the following dishware and materials:

- Heat-resistant glass and ceramic glass  
Exception: crystal glass as it contains lead and may crack.
- Porcelain
  - Without metallic decoration  
Metallic decoration (e.g., gold rims or cobalt blue) can cause sparking.
  - Without hollow knobs and handles  
Moisture can gather in hollow knobs and handles. When the moisture evaporates, pressure can build up and the item can explode.
- Unpainted stoneware and stoneware with underglaze paints

 Danger of injury caused by hot dishware.

Stoneware can get hot.  
Use pot holders when using stoneware.

- Plastic dishware and disposable plastic containers

**Tip:** To protect the environment, avoid the use of disposable containers.

Plastic dishware and bags that are not heat-resistant may melt and fuse with the food inside.

Only use plastic dishware or bags that are heat-resistant. Plastic dishware and bags must be heat-resistant to a minimum of 230°F (110°C).

- Microwave-safe plastic dishware  
Special plastic dishware designed for use in microwave ovens is available from retail outlets.
- Styrofoam dishware  
For briefly heating food.
- Plastic boiling bags  
For cooking and reheating. They should be pierced before use. The holes allow the steam to escape. This prevents a build-up of pressure from forming and the bag from bursting. There are also special bags available for steam cooking which do not need to be pierced. Please follow instructions given on the packet.
- Roasting bags and tubes  
Please follow the manufacturer's instructions.

 Risk of fire due to metal parts.

Metal parts such as metal clips or plastic and paper ties that have wire running through them can heat flammable materials until they burn.

Do not use metal clips or plastic and paper ties containing wire.

**Tip:** Metallic dishes are not very suitable for use in the microwave oven. Metal reflects microwaves and obstructs the cooking process.

Using aluminum foil trays and aluminum foil can cause crackling and sparks.

Place aluminum foil trays on the turntable.

Aluminum foil and aluminum foil trays must not touch the oven compartment walls and must remain at least 3/4" (2 cm) from the walls at all times.

- Aluminum foil trays without lids for defrosting and reheating TV dinners  
The food is only heated from the top. If you remove the food from the aluminum foil container and transfer it to dishware suitable for use in a microwave oven, the heat distribution will generally be more even.
- Metal skewers or clips  
The size of the cut of meat must be much larger than the metal skewers and clips.

## Unsuitable dishware

Moisture can collect in the hollow spaces on dishware and lids with hollow handles or knobs. When the moisture evaporates, pressure can build up and the item can explode. If the hollow recess is sufficiently ventilated, the item can be used.

Do not use dishware with hollow knobs or handles for cooking.

Do **not** use the following dishware and material:

- Wire racks are **not** at all suitable for use in the microwave.
- Metal containers
- Aluminum foil  
Exception: in the case of unevenly shaped cuts of meat – e.g., poultry – small pieces of aluminum foil may be used to cover thin parts for the last few minutes of the process to ensure even defrosting, reheating, or cooking.
- Metal clips, or plastic or paper ties containing wire
- Plastic containers where the aluminum lid has not been completely removed
- Crystal glass
- Utensils and dishware with metallic decoration (e.g., gold rims, cobalt blue)
- Dishware with hollow handles
- Plastic dishware made of melamine  
Melamine absorbs microwave energy and gets hot.

# Microwave operation

When purchasing plastic dishware, make sure that it is suitable for use in a microwave oven.

- Wooden dishes  
Water contained in wood evaporates during the cooking process. This causes the wood to dry and crack.

## Testing dishware

Unsuitable dishware can cause sparks or crackling noises during microwave operation. If you are not sure whether glass, porcelain, or stoneware dishware is suitable, test it.

This test cannot be used to check whether items with hollow grips or handles are suitable for use.

- Place the empty dishware on the turntable.
- Close the door.
- Set the microwave power level to  $\approx 7$  (900 W) and the cooking duration to 30 seconds.
- Start the process.
- Observe the dishware during the entire duration.
- Immediately open the door if there are sparks or crackling noises.

If there are sparks or if you can hear crackling noises, the tested dishware is not suitable for microwave use.

## Cover

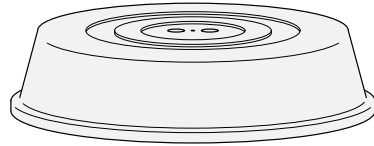

**Tip:** Covers are available from retail outlets.

- A cover prevents too much steam escaping, especially when cooking foods which need longer to cook.
  - It speeds up the process of heating the food.
  - It prevents food from drying out.
  - It helps keep the oven compartment clean.
- When cooking in the microwave, use a microwave-safe cover made of glass or plastic.

**Tip:** Alternatively, use a cling film suitable for use in a microwave oven. Heat can cause normal cling film to melt and fuse with the food.

The cover should not form a seal with the container. If the container has a narrow diameter, the steam may not be able to escape. The cover could get too hot and start to melt.

Use containers with a sufficiently large diameter.

- Do **not** use a cover for heating or reheating the following types of food:
  - Food coated in breadcrumbs
  - Food which requires a crisp finish, e.g., toast

## Basic settings

You must make the following settings before starting up for the first time. You can change these settings again at a later time (see “Settings”).

 Danger of injury caused by hot surfaces

The microwave oven gets hot during operation.

For safety reasons, the microwave oven may only be used when it has been fully installed.

The microwave oven will switch on automatically when it is connected to the electrical supply.

## Setting the language

- Select the desired language.

If you have accidentally selected a language that you don't understand, proceed as described in “Settings – Language ▶”.

## Setting the location

- Select the required location.

## Setting the time

- Set the time of day in hours and minutes.
- Confirm with *OK*.





## Completing the commissioning process

- Follow any further instructions on the display.

The appliance is now ready for use.



# Settings

## Settings overview



Menu option	Available settings
Language 	...   deutsch   english   ... Location
Time	Display Clock display Off*   Clock display On   Night dimming Time 12 h*   24 h Set
Volume	Buzzer tones  Keypad tone 
Display brightness	
Units	Weight g   lb/oz   lb*
Keeping Warm	On* Off
Quick MW	Power Level 80 W   150 W   300 W   450 W   600 W   750 W   900 W* Duration 01:00* min–10:00 min
Popcorn	Duration 2:30 min ... 3:20* min ... 3:50 min
Oven compartment query	On* Off
Safety	Sensor lock On   Off* System lock  On   Off*
Showroom program	Demo mode On   Off*
Factory default	Reset Do not reset

\* Factory default

## Accessing the “Settings” menu

The More  | Settings  menu allows you to personalize your microwave oven by adapting the factory default settings to suit your requirements.

You cannot change settings while a cooking process is in progress.



- Select More .
- Select Settings .
- Select the setting you want.

You can check settings or change them.

## Language

You can set your language and location.

Once you have selected and confirmed your choice, the relevant language will appear on the display.

**Tip:** If you have selected the wrong language by mistake, select the  sensor control. Follow the  symbol to get back to the Language  submenu.

## Time

### Display

Select how you want the time of day to show on the display when the microwave oven is switched off:

- Clock display On  
The time of day is always visible on the display.
- Clock display Off  
The display is darkened to save energy. The microwave oven has to be switched on before you can use it.

- Night dimming  
To save energy, the time of day only shows on the display between 5:00 am and 11:00 pm. The display remains dark at all other times.

### Time

The time of day can be displayed in the 24 or 12-hour format (24 h or 12 h).

### Set



Set the hours and the minutes.

If there is a power failure, the current time of day will reappear once the power has been restored. The time of day is saved for approx. 150 hours.

## Volume



### Buzzer tones

If audible signals are switched on, a signal will sound at the end of a set time.

-   
Maximum volume
-   
Audible signals are switched off

### Keypad tone

The volume of the keypad tone that sounds each time you tap a sensor control is represented by a segment bar.



-   
Maximum volume
-   
Keypad tone is switched off

# Settings

---

## Display brightness

The display brightness is represented by a segment bar.

-  Maximum brightness
-  Minimum brightness

## Units

### Weight

When using automatic programs and other modes, you can set the weight of food in grams (g), pounds/ounces (lb/oz), or pounds (lb).

## Keeping Warm

At the end of a cooking process at microwave power level  (450 W) or higher and a cooking duration of 10 minutes or more, the Keeping Warm function will switch on automatically if the door remains closed and no sensor controls are pressed.

This will happen after approx. 2 minutes and will keep the food warm for up to 15 minutes by using microwave power level  (80 W).

- On  
The Keeping Warm function is switched on. Keeping Warm will appear on the display.  
Opening the door or operating one of the sensor controls cancels the function.
- Off  
The Keeping Warm function is switched off.

## Quick MW

For quick start operation, the default settings are a microwave power level of  (900 W) and a cooking duration of 1 minute.

- Power Level  
The following microwave power levels can be selected: 80 W, 150 W, 300 W, 450 W, 600 W, 750 W, or 900 W.
- Duration  
The maximum cooking duration that can be set depends on the microwave power level selected:  
80–750 W: maximum 10 minutes  
900 W: maximum 5 minutes

## Popcorn

For making popcorn with the microwave, the default settings for quick start operation are a microwave power level of  (900 W) and a cooking duration of 3:20 minutes. You can change the factory default settings by selecting a cooking duration within the range of 2:30–3:50 minutes.

The microwave power level is set and cannot be modified.

## Oven compartment query

Operating the microwave oven while empty can damage it.  
Make sure that some food has actually been placed inside the oven before starting a cooking process.

This prompt reminds you that the microwave oven must not be used without any food inside it.

If you attempt to start a cooking process without opening the door first, the **Place food in oven** prompt will appear on the display.

There may not be any food inside the microwave oven yet, given that you have not opened the door for a long time (approx. 20 minutes). Confirm the prompt with **OK** or by opening and closing the door and selecting the **start sensor control**.

## Safety

### Sensor lock

The sensor lock prevents the cooking process from being switched off by mistake or settings from being changed. When activated, the sensor lock takes effect a few seconds after a cooking process has been started, thereby disabling all sensor controls and fields on the display with the exception of the  **On/Off** button.

- **On**  
The sensor lock is active. Touch the **OK** sensor control for at least 6 seconds to deactivate the sensor lock for a short period of time.
- **Off**  
The sensor lock is not active. All sensor controls react to touch as normal.

### System lock

The system lock prevents the microwave oven from being switched on inadvertently.

The timer can still be used when the system lock is active.

The system lock will remain activated even after a power outage.

- **On**  
The system lock is now active. Before you can use the microwave oven, touch the **OK** sensor control for at least 6 seconds.
- **Off**  
The system lock is now deactivated. You can use the microwave oven as normal.

## Showroom program

This function enables the microwave oven to be demonstrated in showrooms without heating up. Do not activate this setting for domestic use.

### Demo mode

If you have Demo mode activated, **Demo Mode on. Appl. will not heat up. will appear** when you switch on the microwave oven.

- **On**  
To activate Demo mode, touch the **OK** sensor control for at least 4 seconds.
- **Off**  
To deactivate Demo mode, touch the **OK** sensor control for at least 4 seconds. You can use the microwave oven as normal.

## Factory default

- **Reset**  
All changes made will be retained.
- **Do not reset**  
All modified settings will be reset to the factory default settings.

# Operation

---

## Tips for cooking with the microwave

- You can choose from 7 different microwave power levels. The higher the power level, the more microwaves reach the food.
- When heating up foods that cannot be stirred or turned during cooking, or foods with very different consistencies, it is best to use a lower microwave power level. This ensures that the heat is distributed evenly.  
Extend the cooking duration accordingly to cook the food properly.
- Food taken straight from the refrigerator takes longer to defrost, reheat, and cook than food which has been kept at room temperature.
- Fresh vegetables contain more water and cook more quickly than stored vegetables.
- Frequent stirring or turning heats the food more evenly, and it is therefore ready in less time.
- The more food you place inside the oven, the longer it will take to cook (twice the amount = almost twice as long). Reducing the quantity of food shortens the cooking duration.
- The shape of the dishware and material from which it is made may affect the cooking duration (see "Microwave operation – Suitable dishware").

## Using the turntable

Placing food directly on the floor of the oven can cause damage to the microwave oven.

**Always** use the turntable, placing the dishware on top.

The turntable begins turning automatically whenever you start a process. This ensures that the food gets defrosted, reheated, or cooked evenly.

### Tips

- Do not place food directly on the turntable when cooking, reheating, or defrosting.
- Make sure that the dishware is smaller than the turntable.
- Turn or stir food during cooking so that it heats up evenly.
- Switch on the microwave oven.  
Select Operating Mode appears.
- Place the dishware containing the food on the turntable.
- Select the required microwave power level.  
The prompt Duration 00:00 min will appear.
- Set the required cooking duration.
- Confirm with *OK*.

With microwave power level  (900 W), the cooking duration is limited to 15 minutes.

The other microwave power levels allow you to set a cooking duration of up to 90 minutes.

Operating the microwave continuously at full power may result in the power level being reduced by the overheating protection (see “Frequently Asked Questions”).

- Select the Start sensor control.

The cooking process starts.

At the end of the cooking duration, End will appear.



You can also keep the food warm at the end of the cooking process (see “Settings – Keeping Warm”).

- After cooking, select the sensor control for the selected operating mode to end the cooking process.
- Take the food out of the oven.
- Switch off the microwave oven.

## Changing values and settings for a cooking process

Depending on the operating mode, you can change the values or settings for a cooking process as soon as it is running.

### Changing the microwave power level

You can use sensor controls  through  to change the microwave power level during a cooking process.

- Select the required microwave power level.

The cooking process continues running without interruption for the remainder of the cooking duration with the new microwave power level.

### Setting additional durations

Cooking results can be adversely affected if there is a long delay between the food being placed in the oven and the start of cooking. Fresh food can change color and even spoil.

Select as short a time as possible until the start of the cooking process.

You have placed the food in the oven and selected an operating mode.

By entering Duration, Finish at, or Start at via the  sensor control, you can automatically switch the cooking process off or on and off.

# Operation

---

- Duration  
Enter the required cooking duration for the food. The cooking process will stop automatically once this duration has elapsed. The maximum cooking duration that can be set depends on the operating mode that you have selected.
  - Finish at  
Specify when you want the cooking process to finish. The cooking process will stop automatically at this time.
  - Start at  
This function will only appear in the menu if you have set a Duration or Finish at time. With Start at, you have to specify when you want the cooking process to start.
- Select the ⌚ sensor control.
  - Set the required times.
  - Confirm with *OK*.

## Changing set cooking durations

- Select the ⌚ sensor control.
- Select the time you want.
- Confirm with *OK*.
- Select *Change*, if required.

The time will be highlighted.

- Change the set time.
- Confirm with *OK*.
- Press the *Start* sensor control to resume the cooking process.

These settings will be deleted in the event of a power outage.

**Tip:** You can also adjust the cooking duration via the navigation area.

## Deleting the set cooking durations

You can only delete the times set for *Finish at* and *Start at*. The cooking duration must always be set.

- Select the ⌚ sensor control.
- Select the time you want.
- Confirm with *OK*.
- Select *Delete*.
- Confirm with *OK*.

Deleting *Finish at* or *Start at* also deletes the set cooking duration.

## Interrupting and resuming a cooking process

You can interrupt a cooking process (and resume it) at any time.

- Open the door during the cooking process.

The cooking process is interrupted and the cooking duration is paused.

The following message is displayed:

Close the door. If you do not close the door and resume the cooking process, the microwave oven will switch off after a while.

- To resume the cooking process, close the door and select the **Start sensor control**.

The cooking process resumes and the cooking duration continues to count down.

## Canceling a cooking process

- Touch the sensor control for the selected operating mode or the **↶ sensor control**.

Cancel process will appear on the display.

- Confirm with **OK**.

Any cooking durations set will be deleted. The main menu will appear.

# Timer

---

## Using the Timer function

The  timer can be used to time other activities in the kitchen, e.g., boiling eggs.

The timer can also be used at the same time as a cooking process for which automatic start and finish times have been set (e.g., as a reminder to stir the food or add seasoning, etc.).

- The maximum timer duration that can be set is 90 minutes and 00 seconds.

## Setting the timer

Example: you want to boil some eggs and set a timer of 6 minutes and 20 seconds.

- Select the  sensor control.
- Confirm with *OK*.

The prompt **Timer 00:00 min** will appear.

- Using the navigation area, set 06:20.
- Confirm with *OK*.

The timer duration is now saved.

When the microwave oven is switched off,  will be shown together with the running timer instead of the time of day.

If you are in a menu, the timer will count down in the background.

At the end of the timer duration,  will flash, the time will start counting up, and an audible signal will sound.

- Select the  sensor control.
- If required, confirm with *OK*.

The audible signal will stop and the symbols on the display will go out.

## Adjusting the timer during a cooking process

- Select the  sensor control.
- Select **Timer**.
- Confirm with *OK*.

The prompt **Timer 00:00 min** will appear.

- Set the required timer duration.
- Confirm with *OK*.
- Select the  sensor control.

The timer duration is now saved.

The running cooking duration, the  symbol, and the timer countdown are shown on the display side by side.

## Changing the timer duration

- Select the  sensor control.
- Select **Timer** if a cooking process is in progress at the same time.
- Select **Change**.
- Confirm with *OK*.

The timer appears.

- Change the time set for the timer.
- Confirm with *OK*.

The altered timer duration is now saved.

## Deleting the timer

- Select the  sensor control.
- Select **Timer** if a cooking process is in progress at the same time.
- Select **Delete**.
- Confirm with *OK*.

The timer is deleted.

These functions can only be used when no other cooking processes are in use.

## Quick MW

If you select the  sensor control, the microwave starts with a set microwave power level and cooking duration, e.g., to reheat a drink.

The maximum microwave power level of  (900 W) and a cooking duration of 1 minute are set by default.

You can change the microwave power level and the cooking duration. The maximum cooking duration that can be set depends on the microwave power level selected (see “Settings – Quick MW”).

- Select the  sensor control. Touching it repeatedly increases the cooking duration in increments.

The time left will appear on the display.

You can interrupt the cooking process at any time with the  sensor control. Select **Continue process** and start to resume the cooking process, or **Cancel process** to cancel it.

At the end of the cooking process, **Finished** appears on the display and an audible signal sounds.

- Select the  sensor control.

The main menu will appear.

## Popcorn

This function is suitable for making microwave popcorn.

If you select the  sensor control, the microwave starts with a set microwave power level and cooking duration.

Microwave popcorn is commercially available in packs of various sizes. This function is designed for a pack size of approx. 3.5 oz (100 g). A microwave power level of  (900 W) and a cooking duration of 3:20 minutes are set by default.

To accommodate different pack sizes, you can adjust the cooking duration within the range of 2:30–3:50 minutes. The microwave power level is set and cannot be modified (see “Settings – Popcorn”).

This function is not suitable for making popcorn from kernels. Only use this function with products that are specifically labeled as microwave popcorn.



If the pack containing the popcorn comes into contact with the wall of the oven interior and gets stuck there, there is a risk of heat building up. Place the pack **centrally** on the turntable so that it has enough room to expand.

# Quick MW and Popcorn

---

- Place the microwave popcorn on the turntable according to the instructions on the packaging.
- Select the  sensor control.
- Select the start sensor control, if required.

The time left will appear on the display. You will be able to hear the corn popping.



You can interrupt the cooking process at any time by pressing the  or  sensor controls. Select Continue process and start to resume the cooking process, or Cancel process to cancel it.

- Stop the cooking process before the end if the popping noises become infrequent. Follow the instructions on the pack.

 Risk of injury caused by hot popcorn  
The pack containing the microwave popcorn will be very hot at the end of the cooking process.  
Use pot holders to remove the popcorn.

With the wide range of automatic programs, you can achieve excellent results with ease.

The automatic programs are weight-dependent.

The More  | Settings  | Weight menu allows you to set the required unit of weight (g, lb/oz, lb).

## Overview of automatic programs

There are 13  automatic programs to choose from when cooking food.

- Bacon
- Potatoes
- Chicken in sauce
- Fish Fillet
- Fish Fillet in sauce
- Soup
- Vegetables
- Frozen Meals
- Frozen Vegetables
- Fruit Dessert
- Meat in sauce
- Rice
- Casserole

## Using automatic programs

- Select Automatic Programs .

The list of automatic programs will appear.

- Select the automatic program that you want to use.
- Confirm with *OK*.
- Use the arrow keys to choose between the following options: Start now, Start at, and Finish at.
- Follow the instructions on the display, e.g., Turn or Stir the food.

At the end of the cooking process, allow the food to stand at room temperature for approx. 2 minutes. This standing time allows the heat to spread more evenly throughout the food.

## Using the Bacon automatic program

Use this program to make crispy bacon in the microwave oven.

- Select the Bacon automatic program.
- Sandwich the bacon between two sheets of paper towel and place it on a microwave-safe plate.
- Place the food on the turntable.
- Follow the instructions on the display.

# Automatic Programs

---

## Using the Potatoes automatic program

This program can be used to cook peeled, new, and bouillon potatoes.

- Select the Potatoes automatic program.
- Follow the instructions on the display.

About halfway through the cooking duration, an audible signal will sound to prompt you to turn or stir the food.

### Tips

- When cooking peeled potatoes, place them in a bowl with some salt while they are still wet.
- When cooking new potatoes in their skins, add approx. 1 tbsp of water per potato. Pierce the skin of the potatoes with a fork or skewer.
- Enter the weight of the food, including the water.
- Place the food on the turntable, ensuring it is covered. For this, use a cover or microwavable film, for example.

## Using the Fish Fillet automatic program

Use this program to cook ready-prepared fish fillets in the microwave.

- Select the Fish Fillet automatic program.
- Place the ready-prepared, diced fish fillet(s) in a microwave-safe oven dish.
- Enter the weight.

- Place the food on the turntable, ensuring it is covered. For this, use a cover or microwavable film, for example.

- Follow the instructions on the display.

## Using the Vegetables automatic program

- Select the Vegetables automatic program.
- Follow the instructions on the display.

About halfway through the cooking duration, an audible signal will sound to prompt you to turn or stir the food.

### Tips

- Wash the vegetables and prepare them as per the recipe.
- Place the vegetables and other ingredients inside a cooking container and add 3–4 tbsp water.
- Season the vegetables as per the recipe or to taste.
- Enter the weight of the food, including the water. When cooking vegetables in sauce, the weight entered must include the sauce.
- Place the food on the turntable, ensuring it is covered. For this, use a cover or microwavable film, for example.

## Using the Rice automatic program

Use this program to cook rice in the microwave oven.

- Select the Rice automatic program.
- Enter the weight of the dry rice.
- Add boiling water to the rice using a ratio of 1 part rice to 2 parts water.
- Place the food on the turntable, ensuring it is covered. For this, use a cover or microwavable film, for example.
- Follow the instructions on the display.

## Recipes

Here are some recipes for you to try with the automatic programs.

For best results, we recommend using the exact quantities and accessories listed in the recipes.

If the weights given for the relevant programs are exceeded, the food will not be sufficiently cooked, so please observe the guidelines.

## Automatic Programs

---

### Potatoes in a curry sauce

Serves 3

#### Ingredients

1 onion | diced  
1 tbsp butter  
1 lb (500 g) potatoes, waxy | diced  
1–2 tbsp curry powder  
1 cup (250 ml) vegetable stock  
1/4 cup (50 ml) heavy cream  
1/4 lb (125 g) peas, frozen  
Salt  
Pepper

#### Accessories

Bowl, microwave-safe  
Total time required: 35 minutes

#### Method

Mix together all the ingredients in a bowl.

Place the food on the turntable, ensuring it is covered, and cook.

When a signal sounds, stir the vegetables immediately.

#### Setting

Program:  | Potatoes  
Weight: 1 3/4 lb (800 g)

### Chicken breast in mustard sauce

Serves 4

#### Ingredients

1/2 lb (250 g) crème fraîche  
1 clove of garlic | crushed  
4 tbsp mustard, sweet  
1 1/2 tsp salt  
1/2 tsp sage  
4 chicken breast fillets 1/2 lb (200 g) each, ready to cook

#### Accessories

Oven dish, microwave-safe  
Total time required: 30 minutes

#### Method

To make the sauce, mix together the crème fraîche, garlic, mustard, salt, and sage.

Place the chicken breast fillets in the oven dish and spread the sauce over the top.

Place the food on the turntable, ensuring it is covered, and cook.

When a signal sounds, turn the chicken breasts and baste with sauce immediately.

Recover and continue cooking.

#### Setting

Program:  | Chicken in sauce  
Weight: 2 1/2 lb (1,100 g)

#### Tip

Try using wholegrain mustard instead.

## Salmon in white wine sauce

Serves 4

### Ingredients

1.5 lb (700 g) salmon fillet | cut into four fillets and ready to cook  
1 lemon | juiced and sliced  
3 garlic cloves | minced  
2 oz (50 g) butter | cubed  
1 cup (200 ml) white wine  
1 bunch dill | chopped coarsely  
1 bunch parsley | chopped coarsely

### Accessories

Casserole dish, microwave-safe  
Total time required: 25 minutes

### Method

Place all ingredients in the casserole dish.

Place the food on the turntable, ensuring it is covered, and cook.

### Setting

Program:  | Fish Fillet in sauce  
Weight: 2.4 lb (1,100 g)

## Minestrone

Serves 4

### For the minestrone

1/8 lb (50 g) bacon  
1 onion  
1/3 lb (150 g) celery  
2 tomatoes  
1/3 lb (150 g) carrots  
1/4 lb (100 g) beans, green, frozen  
1/4 lb (100 g) peas, frozen  
1/8 lb (50 g) pasta (small shells)  
1 tbsp mixed Italian herbs, frozen  
1/2 cup (100 ml) vegetable stock

### For the garnish

1/4 lb (100 g) hard cheese (Parmesan), whole piece

### Accessories

Glass dish with lid, microwave-safe  
Grater, fine  
Total time required: 40 minutes

### Method

Dice the bacon and onion. Dice the celery and tomatoes, slice the carrots. Put all of these into the glass dish.

Add the beans, peas, pasta, and herbs along with the stock, and stir.

Place the food on the turntable, ensuring it is covered, and cook.

When a signal sounds, stir the soup immediately. Then, recover and continue cooking.

Grate the Parmesan and sprinkle it over the top just before serving.

### Setting

Program:  | Soup  
Weight: 2.2 lb (1,000 g)

# Automatic Programs

---

## Carrots in a chervil cream sauce

Serves 2

### Ingredients

3/4 lb (350 g) carrots | sliced  
1 tsp butter  
1/4 cup (50 ml) vegetable stock  
1/4 lb (75 g) crème fraîche  
1 tbsp white wine  
1/2 tsp sugar  
1/2 tsp salt  
1 tbsp cornstarch  
1/2 tsp mustard  
1–2 tbsp chervil, fresh | chopped  
Pepper

### Accessories

Bowl, microwave-safe  
Total time required: 35 minutes

### Method

Place the carrots in a bowl along with the butter and vegetable stock.

Mix together the crème fraîche, white wine, sugar, salt, cornstarch, mustard, and chervil. Season with pepper to taste. Add the sauce to the vegetables and stir.

Place the food on the turntable, ensuring it is covered, and cook.

When a signal sounds, stir the vegetables immediately.

### Setting

Program:  | Vegetables  
Weight: 1.2 lb (525 g)

## Red berry fruit compote

Serves 4

### Ingredients

3/4 lb (400 g) red berries (e.g., strawberries, raspberries), fresh or frozen  
1/2 cup (100 ml) water  
1/4 cup (50 ml) strawberry syrup  
1–2 tbsp cornstarch  
4 tsp (20 ml) crème de cassis

### Accessories

Bowl, microwave-safe  
Total time required: 20 minutes

### Method

Place the berries in a bowl along with the water and strawberry syrup.

Mix the cornstarch with 2 tbsp water and the crème de cassis, and add to the berries.

Place the food on the turntable, ensuring it is covered, and cook.

### Setting

Program:  | Fruit Dessert  
Weight: 1 lb (500 g)

### Tip

Serve with vanilla ice cream or custard.

## Meatballs

Serves 4

### For the meatballs

1/3 cup (40 g) breadcrumbs  
1/2 cup (110 ml) water  
1 onion | finely diced  
1/2 lb (250 g) ground meat, pork  
1/2 lb (250 g) ground meat, beef  
1 egg, medium  
1 tsp salt  
Pepper

### For the sauce

1.5 oz (40 g) butter | softened  
1.5 oz (40 g) plain white flour  
2 cups (500 ml) meat stock | cold  
2 tbsp heavy cream  
1 tbsp capers  
1 tsp sugar

### Accessories

Oven dish, microwave-safe  
Total time required: 30 minutes

### Method

Mix together the water and breadcrumbs, and leave to soak. Add the onion and ground meat to the breadcrumbs. Add the egg, salt, and pepper, and knead into a meat dough. Shape into 8 meatballs and place in the oven dish. Mix together the butter and flour. Divide this mixture into small portions and place next to the meatballs. Add the meat stock. Place the food on the turntable, ensuring it is covered, and cook. When a signal sounds, immediately stir the sauce gently until smooth. Season with the cream, capers, and sugar to taste. Recover and continue cooking.

### Setting

Program:  | Meat in sauce  
Weight: 3 lb (1,400 g)

## White cabbage stew

Serves 4

### Ingredients

1/2 lb (200 g) ground meat, beef  
1/2 tsp salt  
1/2 tsp paprika, sweet  
Pepper  
1 onion  
1/2 lb (250 g) potatoes  
1/4 lb (100 g) leeks  
1/2 lb (250 g) white cabbage  
1/2 lb (250 g) red beet  
1 cup (250 ml) beef stock  
1 1/2 tsp salt  
1/3 lb (150 g) crème fraîche  
1 tbsp parsley | chopped  
2 tbsp red wine vinegar

### Accessories

Bowl, microwave-safe, Ø 9" (23 cm)  
Grater, coarse  
Total time required: 45 minutes

### Method

Knead together the ground meat, paprika, salt, and pepper. Form into small meatballs and place in the bowl. Dice the onion and potatoes. Cut the leek into rings. Finely slice the white cabbage. Coarsely grate the red beet. Layer the vegetables on top of the meatballs. Add the beef stock and salt. Place the food on the turntable, ensuring it is covered, and cook. Stir in the crème fraîche and parsley. Season with the red wine vinegar to taste.

### Setting

Program:  | Casserole  
Weight: 3 1/2 lb (1,600 g)



# Additional applications

This section provides information on the following applications:

- Defrost
- Reheat
- Cooking
- Canning

## Defrost

Gentle defrosting of frozen food means that the vitamins and minerals are generally retained.

- Use the More  | Defrost mode or the following microwave power levels:
  - Microwave power level  (80 W)  
For defrosting very delicate food, e.g., cream, butter, gateau, buttercream cake, and cheese
  - Microwave power level  (150 W)  
For defrosting everything else
- When using this mode, enter the weight or – if you have selected a microwave power level – the defrosting duration.

Always observe USDA/CFIA food safety guidelines.

 Risk of infection from bacteria. Bacteria such as salmonella can cause life-threatening food poisoning.

It is particularly important to observe food hygiene rules when defrosting fish and meat, and in particular when defrosting poultry.

Do not use the liquid produced during defrosting.

Process the food as required as soon as it has been defrosted.



## Tips for defrosting

- Only use dishware that is microwave safe.
- Remove the frozen food from its packaging and defrost uncovered.
- Place frozen meat on an upturned plate inside a glass or porcelain container. This way the frozen food will not be lying in the defrosted liquid.
- Turn, separate, or stir the food about halfway through the defrosting time.
- Meat, poultry, or fish does not need to be fully defrosted before cooking. Defrost until the food has started to thaw. The surface will then be sufficiently thawed to take herbs and seasoning.

### Tips for combining the Defrost function with subsequent reheating/cooking

Frozen food can be defrosted and then reheated or cooked in the microwave as well.

The time required depends on the nature of the food, its initial temperature, and the amount to be cooked.

- Take the food out of its packaging and place it inside a microwave-safe dish.
- Cover the food.  
Exception: chopped steak should be left uncovered during cooking.
- Select microwave power level  (900 W) first, followed by microwave power level  (450 W).
- If the food has a high water content (e.g., soups and vegetables), stir it several times during cooking.
- Carefully separate and turn slices of meat halfway through.
- Turn pieces of fish at the halfway stage.
- Allow food to stand at room temperature after defrosting and then reheating/cooking it. This standing time allows the heat to spread more evenly throughout the food.

### Using the Defrost mode



There are 13 defrosting categories covering different types of food. The standing time for each one is approx. 10 minutes.

- Select More .
- Select Defrost.

The following list will appear:

- Bread
- Cake
- Chicken Thighs
- Plated Meals
- Fish Fillet
- Fruit
- Meat Pieces
- Ground Meat
- Poultry
- Soup
- Sliced Meat
- Vegetables
- Fish

- Select the desired food category.
- Enter the weight of the food.
- Follow the instructions on the display.

**Tip:** The More  | Settings  | Weight menu allows you to set the required unit of weight (g, lb/oz, lb).

# Additional applications

## Reheat

It is essential that the information in “IMPORTANT SAFETY INSTRUCTIONS – Correct use” is observed.

Always observe USDA/CFIA food safety guidelines.

 Danger of injury caused by hot food.

If food for babies and children is heated at too high a temperature, they can burn themselves.

Only heat food for babies and children for 30–60 seconds at microwave power level  $\approx 4$  (450 W).

After heating food – especially food for babies and small children – stir the food or shake the container, and then taste the food to make sure it will not burn the mouths of the children.

 Danger of injury from increased pressure in sealed containers or bottles

Pressure can build up when reheating food or drinks in sealed containers or bottles, which can cause them to explode.

Never cook or reheat food or liquids in sealed containers or bottles. Open containers beforehand and, with baby bottles, remove the screw top and teat.

Danger of injury caused by hot liquids.

When using the microwave oven to heat food, particularly liquids, the boiling point may be reached without the typical bubbles being produced. The liquid does not boil evenly throughout.

This boiling delay can result in the liquid boiling over explosively. Take care when taking the container out of the oven, as the hot liquid can cause severe scalding. Under certain circumstances, the pressure can be so high that the door bursts open. Stir liquids well before heating or cooking.

After heating, wait at least 20 seconds before removing the container from the oven.

In addition, you can place a glass rod or similar item, if available, in the container during the heating process.

Food with a thick skin or peel, such as tomatoes, sausages, potatoes, and eggplant can burst when heated or cooked.

Pierce or score the skin of these foods several times to allow steam to escape.

Eggs heated in their shell can burst, even after they have been removed from the oven.

Eggs can only be cooked in their shells in a specially designed egg-boiling device. Do not reheat hard-boiled eggs in the microwave oven.

 Danger of burning due to hot surfaces.

The microwave oven gets hot during operation. There is a risk of burning yourself on the hot oven compartment, dishware, or food. Spots of condensation may form on the bottom of the dishware.

Wear oven gloves when reaching into the hot oven compartment and when removing the dishware.

### Tips on reheating

- Only use dishware that is microwave safe.
- Always cover food when reheating it, except when reheating food coated in breadcrumbs.
- The time required depends on the nature of the food, its initial temperature, and the amount to be cooked. For example, food taken straight from the refrigerator takes longer to reheat than food which has been kept at room temperature. Take note of the standing times.
- Turn, separate, or stir the food several times. Stir the food from the outside toward the middle, as food heats up more quickly at the edges.
- The purpose of the standing time is to allow the food to develop a more even temperature.
- After reheating, allow the food to stand at room temperature for a few minutes to enable the heat to spread more evenly throughout the food.



### Using the Reheat mode

There are 8 reheating categories covering different types of food. The standing time for each one is approx. 2 minutes.

- Select More .
- Select Reheat.

The following list will appear:













- Bakes
- Chicken in sauce
- Plated Meals
- Fish Fillet in sauce
- Soup
- Meat in sauce
- Casserole
- Vegetables
- Select the desired food category.
- Enter the weight of the food.
- Follow the instructions on the display.

**Tip:** The More  | Settings  | Weight menu allows you to set the required unit of weight (g, lb/oz, lb).

## Additional applications

### Examples of heating food

The information provided in this chart is intended as a guide only.

Food	Quantity		 [min]	Comment
Melting butter/margarine	1/4 lb (100 g)		1:00–1:10	Do not cover
Melting chocolate	1/4 lb (100 g)		3:00–3:30	Do not cover, stir halfway through melting
Dissolving gelatin	1 packet + 5 tbsp water		0:10–0:30	Do not cover, stir halfway through dissolving
Preparing flan topping/fruit glaze	1 packet + 1 cup (250 ml) liquid		4:00–5:00	Do not cover, stir halfway through heating
Yeast dough	Starter made with 1/2 cup (100 g) flour		3:00–5:00	Cover and leave to proof
Chocolate marshmallows	0.7 oz (20 g)		0:10–0:20	Place on a plate, do not cover
Salad dressings	1/2 cup (125 ml)		1:00–2:00	Heat uncovered at low power to bring out flavor
Tempering citrus fruits	1/3 lb (150 g)		1:00–2:00	Place on a plate, do not cover
Softening ice cream	1 lb (500 g)		1:00–3:00	Place inside oven, uncovered
Skinning tomatoes	3 tomatoes		6:00–7:00	Cut a cross into the top of each tomato, cover, and heat in a little water. The skins will slip off easily. The tomatoes can get very hot.
Making strawberry jam	1 lb (300 g) strawberries, 1½ cups (300 g) gelling sugar		7:00–9:00	Mix the fruit and sugar in a deep bowl, cover and cook.

 microwave power level,  cooking duration

### Cooking

It is essential that the information in “IMPORTANT SAFETY INSTRUCTIONS – Correct use” is observed.

 Risk of infection due to insufficient cooking

Highly perishable foods – e.g., fish – must be cooked thoroughly. Otherwise, they can pose a health risk.

It is essential to cook highly perishable foods for a sufficient length of time.

 Danger of burning due to hot surfaces.

The microwave oven gets hot during operation. There is a risk of burning yourself on the hot oven compartment, dishware, or food. Spots of condensation may form on the bottom of the dishware. Wear oven gloves when reaching into the hot oven compartment and when removing the dishware.

Food with a thick skin or peel, such as tomatoes, sausages, potatoes, and eggplant can burst when heated or cooked.

Pierce or score the skin of these foods several times to allow steam to escape.

Eggs heated in their shell can burst, even after they have been removed from the oven.

Eggs can only be cooked in their shells in a specially designed egg-boiling device. Do not reheat hard-boiled eggs in the microwave oven.

If you cook eggs without their shells, there is a risk of the yolks exploding due to the resulting pressure.

Prick the yolk several times before cooking to avoid this.

### Tips for cooking

- Only use dishware that is microwave safe.
- Always use a cover.
- The time required depends on the nature of the food, its initial temperature, and the amount to be cooked. For example, food taken straight from the refrigerator takes longer to cook than food which has been kept at room temperature. Take note of the standing times.
- Fresh vegetables contain more water than vegetables which have been stored, and usually cook more quickly. Add 3–4 tbsp of water to vegetables which have been stored.
- Turn, separate, or stir the food several times. Stir the food from the outside toward the middle, as food heats up more quickly at the edges.

# Additional applications

- The purpose of the standing time is to allow the food to develop a more even temperature.
- After cooking, allow the food to stand at room temperature for a few minutes to enable the heat to spread more evenly throughout the food.
- If possible, use the automatic programs for cooking.
- Select microwave power level  $\approx 7$  (900 W) to start cooking and then continue cooking at power level  $\approx 4$  (450 W).
- When cooking foods that swell, such as rice pudding or semolina, start with microwave power level  $\approx 7$  (900 W) and then switch to power level  $\approx 2$  (150 W).

## Canning

 Risk of infection from bacteria. The spores of the botulinum bacterium are not sufficiently killed by canning pulses and meat only once. Toxins may form which can lead to serious poisoning. These spores are only destroyed by canning the food again. After they have cooled down, **always** reheat pulses and meat a second time within 2 days.

If unsuitable materials are used, there is a risk of generating sparks and damaging the microwave oven as a result. Use microwave-safe canning jars and seal them with clear adhesive tape or clips suitable for microwave use. Do not use metal clips, jars with screw-top lids, or cans, as these will generate sparks.

Always observe USDA/CFIA food safety guidelines.

### Preparing fruit and vegetables

The instructions are for a maximum of 4 jars with a capacity of 2 cups (0.5 l) each.

Only use special jars from a specialist retailer (microwave-safe canning jars with glass lids, sealed with clear adhesive tape).

- Only use undamaged jars.
- Rinse the jars with hot water before canning and fill them up to a maximum of 3/4" (2 cm) below the rim.
- Seal the jars with clear adhesive tape only.  
Do not use metal clips, jars with screw-top lids, or cans, as these will generate sparks.
- Place the jars on the turntable.

### Canning fruit and vegetables

- Select microwave power level  $\approx 7$  (900 W).
- Wait until bubbles rise evenly in the jars. This takes about 3 minutes per jar. With 4 jars, therefore, it takes 12 minutes.

This is sufficient time for canning fruit and cucumbers.

- When canning other vegetables, reduce the microwave power level to microwave power level  $\approx 4$  (450 W) as soon as bubbles become visible in the jars.
- Continue cooking at microwave power level  $\approx 4$  (450 W) for approx. 15 minutes if canning carrots and for approx. 25 minutes if canning peas.

### Removing the jars after canning

 Danger of injury caused by hot surfaces

The jars will be very hot after canning.

Use oven gloves when removing the jars from the oven.

- Take the jars out of the oven.
- Cover the jars with a towel and leave to stand for approx. 24 hours in a draft-free area.
- After they have cooled down, **always** reheat pulses and meat a second time within 2 days.
- Remove the clips or the adhesive tape and then make sure that all jars are sealed properly.

Either boil open jars again or store them in a cool place and consume the canned fruit or vegetables immediately.

- Check the jars during storage. If jars have opened during storage or if the screw cap is bulging and does not make a popping noise when opened, destroy the contents.

## Cleaning and care

 Danger of injury caused by hot surfaces

The microwave oven gets hot during operation. There is a risk of burning yourself on the hot oven compartment or accessories.

Allow the oven compartment and accessories to cool before manual cleaning.

 Risk of injury due to electric shock

The steam from a steam cleaner could reach live electrical components and cause a short circuit.

Never use a steam cleaner for cleaning.

 Fire hazard due to excessive soiling

Under certain circumstances heavy soiling can catch fire, damaging the the microwave oven.

Clean the oven compartment and inside of the door as soon as they have cooled. Waiting too long to clean the oven will make it much more difficult to clean.

All surfaces could become discolored or damaged if unsuitable cleaning agents are used. The front of the microwave oven is particularly susceptible to damage from oven cleaners.

All surfaces are susceptible to scratching. Scratches on glass can lead to breakage in some circumstances.

Remove all cleaning agent residues immediately.

Operating a damaged microwave oven can result in microwave leakage and present a hazard to the user.

Check the door for damage. If any damage is seen, the microwave oven should **not** be used again until it has been repaired by a service technician. Contact Miele.

## Unsuitable cleaning agents

To avoid damaging the surfaces of your appliance, do not use:

- Cleaning agents containing soda, ammonia, acids, or chlorides
- Cleaning agents containing descaling agents on the front
- Abrasive cleaning agents (e.g., powder cleaners and cream cleaners)
- Solvent-based cleaning agents
- Stainless-steel cleaners
- Dishwasher cleaning agents
- Oven cleaners
- Glass cleaners
- Cleaning agents for ceramic-glass cooktops
- Hard, abrasive brushes or sponges (e.g., pot scourers, brushes, or sponges which have been previously used with abrasive cleaning agents)
- Eraser sponges
- Sharp metal scrapers
- Steel wool
- Spot cleaning with mechanical cleaning agents
- Stainless-steel spiral pads

If soiling is allowed to sit for any length of time, it may become impossible to remove. If the appliance is used frequently without being cleaned, it may become very difficult to clean. It is therefore best to remove any soiling immediately.

## Removing soiling

Moisture inside the microwave oven can cause damage.

Do not use too much water on the cloth or sponge and do not let water or any other liquid find its way into any internal oven openings.

- Remove soiling immediately with warm water, liquid dish soap, and a clean sponge or a clean, damp microfiber cloth.
- Remove all cleaning agent residues thoroughly with clean water.
- After cleaning, wipe the surfaces dry using a soft cloth.
- For heavier soiling, heat a glass of water inside the oven compartment for 2–3 minutes until the water begins to boil. The steam will collect on the oven compartment walls and soften the soiling. You will then be able to remove the soiling (using a little dish detergent if necessary).
- To neutralize odors in the oven compartment, put a container of water with some lemon juice inside the microwave oven and heat for a few minutes.

# Cleaning and care

## Cleaning the oven compartment

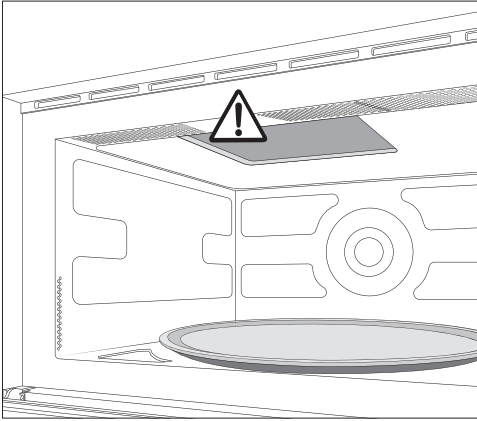

There is a cover protecting the microwave outlet on the ceiling of the oven, which is susceptible to damage.

**Never** remove the cover from the microwave outlet.

Do not use the abrasive side of the dishwashing sponge to clean the ceiling of the oven.

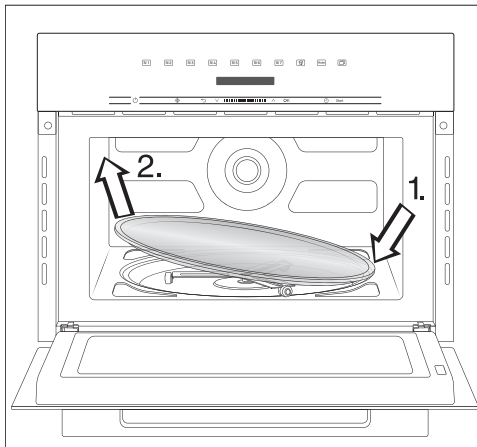

- To remove the turntable, press down on one side (1.) and lift it up by the other (2.).

- Wash the turntable in the dishwasher or by hand with a weak solution of dish detergent.

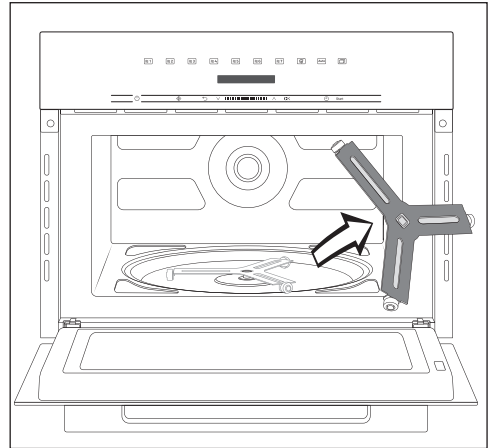

Do not turn the support manually, as this can damage the drive motor.

- Remove the support on which the turntable normally rotates.
- Clean the support and the floor of the oven. Otherwise the turntable will not rotate smoothly.
- Clean the contact surfaces between the turntable and the support.
- Put the support back inside and place the turntable on top.



# Frequently Asked Questions

With the help of the following guide minor faults in the performance of the machine, some of which may result from incorrect operation, can be remedied without contacting the Service Department.

This guide may help you to find the reason for the fault, and how to correct it.

Problem	Possible cause and solution
<b>The display is dark.</b>	<p>You have selected the <b>Time   Display   Clock display Off</b> setting. As a result, the display remains dark when the microwave is switched off.</p> <ul style="list-style-type: none"> <li>■ As soon as you switch on the microwave oven, the main menu will appear. If you want the time of day to be displayed constantly, select the <b>Time   Display   Clock display On</b> setting.</li> </ul> <p>There is no power running to the microwave oven.</p> <ul style="list-style-type: none"> <li>■ Check that the electrical plug of the microwave oven is correctly inserted in the outlet.</li> <li>■ Check if the breaker has tripped. If it has, contact a qualified electrician or Miele Customer Service.</li> </ul>
<b>You cannot start a cooking process.</b>	<p>The door is still open.</p> <ul style="list-style-type: none"> <li>■ Check whether the door is closed properly.</li> </ul> <p>There is no power running to the microwave oven.</p> <ul style="list-style-type: none"> <li>■ Check that the electrical plug of the microwave oven is correctly inserted in the outlet.</li> <li>■ Check if the breaker has tripped. If it has, contact a qualified electrician or Miele Customer Service.</li> </ul>
<b>The sensor controls do not respond.</b>	<p>There is no power running to the microwave oven.</p> <ul style="list-style-type: none"> <li>■ Check that the electrical plug of the microwave oven is correctly inserted in the outlet.</li> <li>■ Check if the breaker has tripped. If it has, contact a qualified electrician or Miele Customer Service.</li> </ul>
Place food in oven <b>appears on the display.</b>	<p>This prompt reminds you that the microwave oven must not be used without any food inside it. There may not be any food inside the microwave oven yet, given that you have not opened the door for a long time (approx. 20 minutes).</p> <ul style="list-style-type: none"> <li>■ Make sure that some food has actually been placed inside the oven.</li> <li>■ Confirm the prompt with <b>OK</b> or by opening and closing the door and selecting the <b>start</b> sensor control.</li> </ul>

## Frequently Asked Questions

Problem	Possible cause and solution
<p>Press OK for 6 seconds <b>appears on the display when the oven is switched on.</b></p>	<p>The  system lock is activated.</p> <ul style="list-style-type: none"> <li>■ You can deactivate the system lock for a cooking process by touching the <i>OK</i> sensor control for at least 6 seconds.</li> <li>■ If you want to permanently deactivate the system lock, select the <i>Safety   System lock    Off</i> setting.</li> </ul>
<p>Power Failure <b>appears on the display.</b></p>	<p>There has been a brief power failure. This has caused the current cooking process to stop.</p> <ul style="list-style-type: none"> <li>■ Switch the microwave oven off and on again.</li> <li>■ Restart the cooking process from the beginning.</li> </ul>
<p>12:00 <b>appears on the display.</b></p>	<p>There was a power failure for more than 150 hours.</p> <ul style="list-style-type: none"> <li>■ Reset the time of day.</li> </ul>
<p><b>The turntable is very jerky.</b></p>	<p>The turntable, support, or floor of the oven may be dirty.</p> <ul style="list-style-type: none"> <li>■ Clean the turntable, support, and floor of the oven.</li> <li>■ Clean the contact surfaces between the turntable and the support.</li> <li>■ Put the support back inside and place the turntable on top.</li> </ul>
<p><b>A noise is heard after the cooking process is complete.</b></p>	<p>After the cooking process the cooling fan will continue to run for a while after a program is complete to prevent moisture from building up in the oven, on the control panel or surrounding cabinetry.</p> <p>The cooling fan will turn off automatically.</p>
<p><b>An abnormal sound can be heard during a cooking process.</b></p>	<p>A metal dish has been used during a cooking process.</p> <ul style="list-style-type: none"> <li>■ Check if the metal dishes you have been using generate sparks (see “Microwave operation – Suitable dishware”).</li> </ul> <p>The food was covered with aluminum foil during a cooking process.</p> <ul style="list-style-type: none"> <li>■ Remove the foil, if applicable.</li> </ul>

## Frequently Asked Questions

Problem	Possible cause and solution
<p><b>The microwave oven has switched itself off.</b></p>	<p>There is insufficient air circulation.</p> <ul style="list-style-type: none"> <li>■ Check whether the vents are blocked. Remove the obstructions, if applicable.</li> </ul>
	<p>For safety reasons, the microwave oven is designed to switch off if it overheats.</p> <ul style="list-style-type: none"> <li>■ Resume the cooking process once the oven has cooled down.</li> </ul>
	<p>The microwave oven keeps switching itself off.</p> <ul style="list-style-type: none"> <li>■ Contact Miele Customer Service.</li> </ul>
<p><b>The food has not been defrosted, heated, or cooked sufficiently on completion of the cooking process.</b></p>	<p>Check whether the cooking process was interrupted without restarting it.</p> <ul style="list-style-type: none"> <li>■ Restart the cooking process to ensure the food gets defrosted, heated, or cooked properly.</li> </ul>
	<p>The cooking duration you set was too short.</p> <ul style="list-style-type: none"> <li>■ Check that the correct duration is selected for the microwave power level. The lower the microwave power level, the longer the duration required.</li> </ul>
<p><b>Food has cooled down too quickly after being reheated or cooked using microwave power.</b></p>	<p>In the microwave, food begins to cook from the outside first, the inside of the food relying on the slower conduction of heat. If food is cooked at a high microwave power level, it is possible that the heat may not have reached the center of the food, so it is hot on the outside but cold in the centre. During the standing time, the heat is transferred to the center of the food.</p> <ul style="list-style-type: none"> <li>■ When reheating food with different densities, such as with menu cooking, it is sensible to start with a low microwave power level and select a longer reheating duration.</li> </ul>
<p><b>The oven interior lighting does not switch on.</b></p>	<p>The lamp is faulty. You can operate the appliance as usual, but the lamp has blown.</p> <ul style="list-style-type: none"> <li>■ Contact Miele Customer Service.</li> </ul>

# Customer Service

---

## Contact in the event of a fault

In the event of a fault which you cannot remedy yourself, please contact your Miele dealer or Miele Customer Service.

You can book a Miele Service Call online at [www.miele.com/service](http://www.miele.com/service).

Contact information for Miele Customer Service can be found at the end of this document.

Please quote the model identifier and serial number of your appliance (SN) when contacting Miele Customer Service. Both pieces of information can be found on the data plate.

This information is given on the data plate, which is visible on the front frame of the oven when the door is fully open.

## Appliance warranty and product registration

You can register your product and/or view the manufacturer's warranty terms and conditions for Miele appliances and vacuum cleaners at [www.mieleusa.com](http://www.mieleusa.com).

**Please have the model and serial number  
of your appliance available when  
contacting Customer Service.**

---

## **U.S.A.**

**Miele, Inc.**

### **National Headquarters**

9 Independence Way  
Princeton, NJ 08540  
[www.mieleusa.com](http://www.mieleusa.com)

### **Customer Support**

Phone: 888-99-MIELE (64353)  
[info@mieleusa.com](mailto:info@mieleusa.com)

### **International Headquarters**

Miele & Cie. KG  
Carl-Miele-Straße 29  
33332 Gütersloh  
Germany

## **Canada**

**Importer  
Miele Limited**

### **Headquarters and Miele Centre**

161 Four Valley Drive  
Vaughan, ON L4K 4V8  
[www.miele.ca](http://www.miele.ca)

### **Customer Care Centre**

Phone: 800-565-6435  
905-532-2272  
[customercare@miele.ca](mailto:customercare@miele.ca)

M 7240 TC

en-US, CA

M.-Nr. 12 003 550 / 00