

## INSTRUCTIONS FOR MODELS

S-2251



### NEED HELP?

For additional assistance or service please contact:

**SPEAKMAN**® Company  
400 Anchor Mill Road  
New Castle, DE 19720

 800-537-2107

 customerservice@speakman.com

 www.speakman.com

92-S-2251-R6



## TOOLS AND SUPPLIES

Thread Seal  
Tape

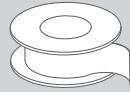

Adjustable  
Wrench



### IMPORTANT



Be sure to read instructions thoroughly before beginning installation. Do not overtighten any connections or damage may occur. This showerhead has an optimal operating range of 20-80 psi.

### SAFETY TIPS

Cover your drain to prevent loss of parts.

### MAINTENANCE

Periodic cleaning using a mild soap and warm water will help keep your Showerhead's appearance in its original condition.

For best results, dry immediately with a soft, clean cloth. **DO NOT USE** harsh and/or abrasive cleaners.

To help restore the finish, occasionally apply a non-abrasive wax to your showerhead body (follow manufacturers' instructions).

On **CHROME PLATED SHOWER HEADS**, a two (2) part white vinegar, one (1) part water solution can be used to break down excessive mineral deposits on the sprays. Let the showerhead soak in the solution for about ½ hour then rinse thoroughly. Brush off any remaining mineral deposits if necessary.

**DO NOT USE** the vinegar/water treatment on any finish other than Chrome.

To reduce mineral build-up, turn the handle to **FLOOD** position to let the water drain out after every use.

### WARRANTY

Additional warranty information can be found at:  
[www.speakman.com](http://www.speakman.com)

- 1 Apply Teflon Tape to the outlet side of shower arm in a clockwise direction.

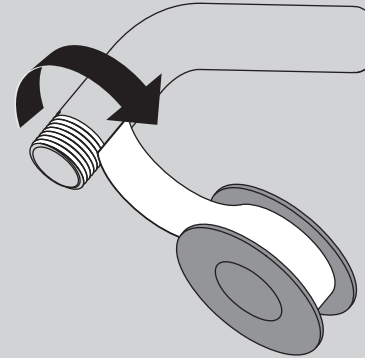

- 2 Thread Showerhead onto shower arm by turning it in a clockwise direction. Tighten with adjustable wrench. Turn water supply on and check for leaks.

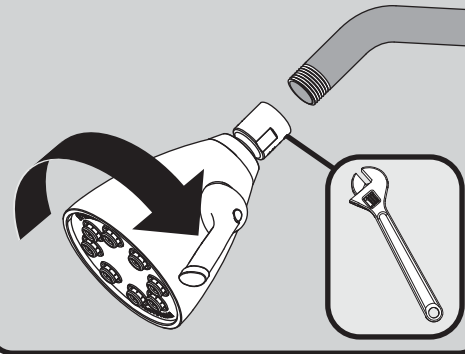

- 3 Adjust spray pattern by rotating side handle to preferred Anystream® position.

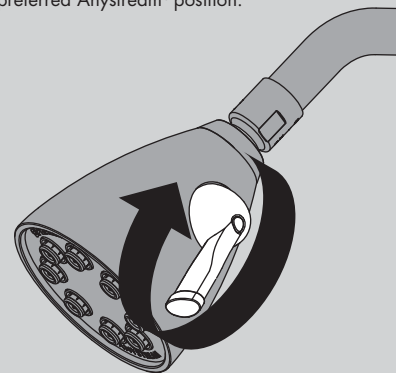

## ROUGH IN DIMENSIONS

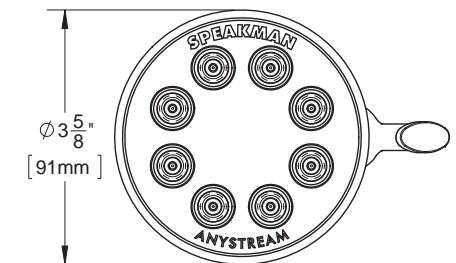
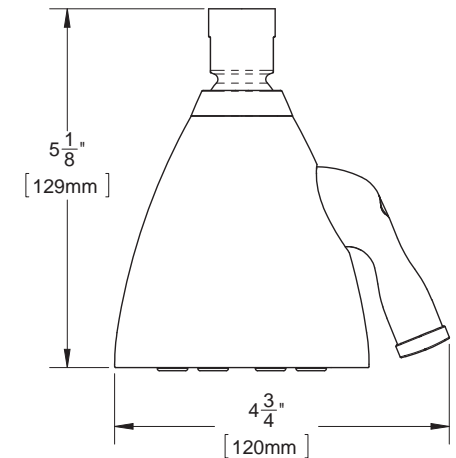

### Specifications:

Inlet: 1/2" NPT FEMALE