

Midea Built-in Electric Oven Instruction

MO5BL



SAVE THESE INSTRUCTIONS CAREFULLY

Read these instructions carefully before using your oven, and keep it carefully. If you follow the instructions, your oven will provide you with many years of good service.

ACKNOWLEDGMENT

Thank you for purchasing our product. We hope you enjoy using the many features and benefits it provides. Before using this product please study this entire Instruction Manual carefully. Keep this manual in a safe place for future reference. Ensure that other people using the product are familiar with these instructions as well.

WARNING

- When the oven is first switched on, it may give off an unpleasant smell. This is due to the bonding agent used for the insulating panels within the oven. This is completely normal, if it does occur, you merely need to wait the smell to disappear before putting food into the oven.
- The appliance and its accessible parts become hot during use. Care should be taken to avoid touching heating elements.
- Children less than 8 years of age shall be kept away from the oven unless being continuously supervised.
- This appliance can be used by children aged from 8 years and above and persons with reduced physical, sensory or mental capabilities or lack of experience and knowledge if they have been given supervision or instruction concerning use of the appliance in a safe way and understand the hazards involved. Children shall not play with the appliance. Cleaning and user maintenance shall not be made by children without supervision.

- Do not use harsh abrasive cleaners or sharp metal scrapers to clean the glass of the oven. This can scratch the surface and may result in permanent damage to the glass.
- Do not allow children to go near the oven when it is operating, especially when the grill is on.
- Ensure that the appliance is switched off before replacing the oven lamp to avoid the possibility of electric shock.
- The means for disconnection must be incorporated in the fixed wiring in accordance with the wiring specifications.

SAFETY HINTS

- Do not use the oven unless you are wearing something on your feet. Do not touch the oven with wet or damp hands or feet.
- For oven: Oven door should not be kept open often during the cooking period.
- The appliance must be installed by an authorized technician to put into use. The producer is not responsible for any damage that might be caused by defective placement, and installation by unauthorized personnel.
- When the door or drawer of oven is open do not leave anything on it, you may unbalance your appliance or break the door.
- Some parts of appliance may be kept heat for a long time; it is required to wait for it to cool down before touching onto the points that are exposed to the heat directly.
- If you will not use the appliance for a long time, it is advised to turn it off at the power source.
- If the supply cord is damaged, it must be replaced by the manufacturer, its service agent or similarly qualified persons in order to avoid a hazard.
- Excess spillage must be removed before cleaning.
- Only use the temperature probe recommended for this oven.
- A steam cleaner shall not be used.

FITTING THE OVEN INTO THE KITCHEN UNIT

Fit the oven into the space provided in the kitchen unit; it may be fitted underneath a worktop or into an upright cupboard. Fix the oven in position by screwing into place, using the two fixing holes in the frame. To locate the fixing holes, open the oven door and look inside. To allow adequate ventilation, the measurements and distances shall be adhered to when fixing the oven.

IMPORTANT

Ensure that cabinetry can withstand temperatures of at least 120 degrees. Materials that cannot withstand such temperatures may melt and deform the unit.

Once the oven has been positioned inside the cabinet electrical wiring must be completely insulated. This is a legal safety requirement. Ensure sufficient space at the rear of the cabinet to allow an air flow clearance of at least 45mm.

DECLARATION OF COMPLIANCE

When you have unpacked the oven, make sure that it has not been damaged in any way. If you have any doubts at all, do not use it: contact a professionally qualified person. Keep packing materials such as plastic bags, polystyrene, or nails out of the reach of children because these are dangerous to children.



HOW TO USE

- Stay on: For the oven to be used in the “◊”, the food may catch fire if the cooking time is set too long. Close supervision is necessary during toasting and the time should not be set too long.
Note: For cooking times which are under sixty minutes, first set to a longer time and then turn the switch back to the time you require.
- To set functions by turning the function knob to desired level.
The oven will automatically start cooking after function, time and temperature are set.
- To set the time of cooking by turning the timer knob to desired time per your food cooking guide.
After the cooking time is up, the unit will “Dong” to stop.
- To set the temperature by turning the temperature knob.
If the unit is not in use, always set the knobs to “0”.

PRODUCT DESCRIPTION

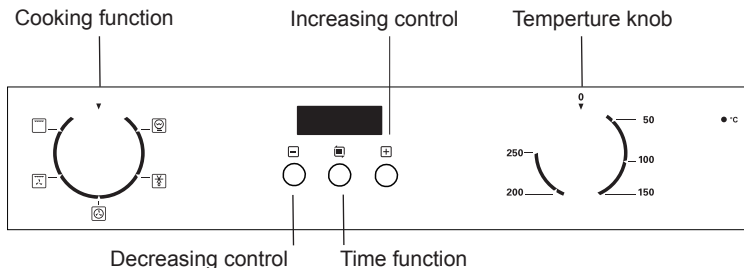

Symbol	Function description
	Oven Lamp: It enables the user to observe the progress of cooking without opening the door.
	Defrost: The circulation of air at room temperature enables quicker thawing of frozen food, (without the use of any heat). It's a gentle but quick way to speed up the defrosting time and thawing of ready-made dishes and cream filled produce etc.
	Convectional with fan: Combination of the fan and back element provides more even heat penetration, saving up to 30-40% of energy. Dishes are lightly browned on the outside and still moist on the inside. Note: This function is suitable for grilling or roasting big pieces of meat at a higher temperature.
	Radiant grilling: The inner grill element switches on and off to maintain temperature. Best results can be obtained from using the top shelf for small items and lower shelves for large items.
	Grilling with fan: The inner grill element work with fan.

OPERATION INSTRUCTIONS

When the oven is first connected to the electrical supply, wait for the display automatically show "12.30", a beep sound once and the "12"." flash. Ensure the correct time of the day is set before using the oven. please note: that is 24 hour clock, for example 2PM shown as 14.00.

To set the correct time of day

- 1> Press "+" "-" button to adjust the hour setting.
- 2> Press " " to confirm the hour setting.
- 3> Press "+" "-" button to adjust the minute setting.
- 4> Press " " to confirm the minute setting and the timer will be in standby mode.

Note: If the display does not flash, pressing the "+" and "-" buttons at the same time for more than 3 seconds.

Oven On and Off

If the timer is in standby mode, press " " for more than 3 seconds, the timer will enter into manual mode and the symbol " ", " will light up continuously.

- 1> Set the desired cooking function and the temperature degree.
- 2> Set the time function, then the oven will start cooking.

If you set Dur or End , after cooking, the oven will automatically turn off.

If you set manual or minute minder, after cooking, turn the cooking function and oven temperature knob to " 0 " position. Press " " and "+" buttons for more than 3 seconds to return to standby mode.

Time function setting

In manual mode, pressing " " can enter the time function setting, the sequence of the function setting is Manual mode - Minute minder-Dur-End-Manual mode. Then select cooking function and adjust the cooking, temperature if needed.

Manual mode :











In manual mode, only the day's time and the symbol " ", " lights up. The cooking duration has to be controlled by the user.

Notes: In manual mode, to ensure the oven is not left on accidentally, after 5 hours, if there is no any button pressed, the timer will flash once a second to warn you the oven will enter into standby mode. Then after 10 hours, the timer will enter into standby mode.

When the timer is flashing in manual mode, press any button to reset the timer if you intend to continue using the oven. Or press " " and "+" together for more than 3 seconds to enter into standby mode if oven will not be used.

Audible warning time adjustment:







This function can be used to receive audible warning at the completion of the adjusted time period.

- 1> Press "  " button to select the minute minder function. The relevant "  " " symbol will flash.
- 2> Use "  " "  " button to adjust minute minder. (Refer to the instructions for setting the correct time of day.) Press "  " button to confirm, the "  " symbol will begin to light continuously. When the "  " symbol begins to light continuously, the audible warning time adjustment is done.
- 3> When the time is up, the timer gives an audible warning and the "  " symbol begins to flash on the screen. Press any button less than 3 seconds, it will stop the audible warning and the "  " symbol disappears on the screen. Audible warning time adjustment is for warning purposes only.
Press "  " and "  " together for more than 3 seconds to enter into standby mode if oven will not be used.

Semi-automatic programming according to cooking period:





This function is used to cook in the desired time range, Put the food into the oven, and the oven is adjusted to the desired cooking function and temperature degree.

The maximum setting of cooking period is 10 hours.

- 1> Press "  " button until you see " Dur " on the timer screen. (Before setting cooking period.)
- 2> Use "  " "  " button to adjust cooking period for the food you wish to cook. (Refer to the instructions for setting the correct time of day.) Press "  " button to confirm the day's time will appear on the screen and the symbols " A " "  " will light on the screen While doing this, the oven will also start to operate.
- 3> At the completion of the set duration, the timer will stop the oven and give an audible warning. Also, the symbol "A" will begin to flash on the screen. After turning the cooking function and oven temperature knob to position Pressing any button less than 3 seconds it will stop the audible warning.
Pressing "  " for more than 3 seconds set the oven to Manual mode again to use the oven.





Semi-automatic programming according to finishing time:





This function is used to cook according to the desired finishing time. Put the food into the oven. The food to be cooked is put into the oven. The oven is adjusted to the desired cooking function and temperature degree.

- 1> Press "  " button until you see " End " on the timer screen. (Before setting finished time).
- 2> Use button to adjust finishing time. (Refer to the instructions for setting the correct time of day.)
- 3> Press "  " button to confirm, the day's time will appear on the screen and the symbols "A" "  " will light on the screen. While doing this, the oven will also start to operate.
- 4> At the completion of the set duration, the timer will stop the oven and give an audible warning Also, the symbol "A" will begin to flash on the screen. After bringing the cooking function and oven temperature knob to " 0 " position Pressing any button less than 3 seconds, it will stop the audible warning.
Pressing "  " for more than 3 seconds set the oven to Manual mode again to use the oven.

Full-automatic programming:

This function is used to cook after a certain period of time with a certain duration, The food to be cooked is put into the oven The oven is adjusted to the desired cooking function. The oven temperature is adjusted to the desired degree depending on the food to be cooked.

First: Press "  " button until you see " Dur " on the timer screen. Use "  "  " button to adjust cooking period for the food you wish to cook. Press "  " button to confirm, the day's time will appear on the screen and the symbols " A " will begin to continuously light on the screen.





Second: keep pressing on "  " button until you see " End " on the timer screen. When you see " End " on the timer screen, Use "  "  " button to adjust finishing time, Press "  " button to confirm, the day's time will appear on the screen and the symbol " A " will begin to continuously light on the screen. The symbol "  " disappears until the time cooking starts.

You can set a time which can be up 23.59 hours after the time obtained by adding the cooking period to the day's time.

The oven will start operating at the time calculated by deducting the cooking period from the set finishing time, and will stop at the set finishing time. The timer will give an audible warning and the symbol "A" will begin to flash .After bringing the cooking function and oven temperature to " 0 " position. any button less than 3 seconds, it will stop the audible warning.

Pressing "  " for more than 3 seconds set the oven to Manual mode again to use the oven. Please note Once setting full:-automatic mode all the, time can no t be changed Change. time means cancle automatic programme and enter into corresponding mode If you need to reset automatic mode, need to stop setting the current mode to set the automatic mode according to the above steps again.

Spectification

- 1> When setting the date of each function, long press on "  " or "  " for more than 3 seconds the date will progressively and rapidly increase or decrease.
- 2> When setting each of the time function, if there is none operation for 5 minutes then it will return to manual mode.
- 3> When setting each of the time function, pressing on "  " for more than 3 seconds can cancel current setting and enter manual mode.
- 4> During time function setting, pressing on " + " and "  " for more than 3 seconds, a beep sounds it can cancle the curent time function setting and enter standby mode.
- 5> We suggest that you run the oven elements for 15 minutes at 200 degrees to burn off any residue from their surfaces.

ACCESSORIES

Wire shelves: For grill. dishes, cake pan with items for roasting and grilling.

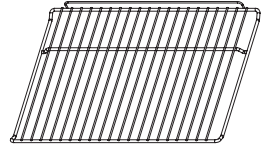

Universal pan: For cooking large quantities of food such as moist cakes, pastries, frozen food etc, or for collecting fat/spillage and meat juices.

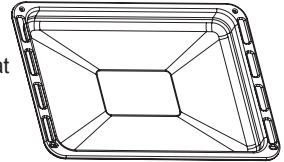

Telescopic runner: Some models may be supplied with telescopic runners. These telescopic runners and slider brackets could be disassembled by unscrewing the screws used to fix it. After disassembled, dishes and tray can be put on the side racks, using functions as Radiant grilling, Double grilling, Double grill with fan.

NOTE: When placing dishes on the oven floor, please DO NOT use functions with bottom heater to prevent heat gathering at bottom. (only for specific models)

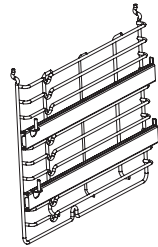

SHELF PLACEMENT WARNING

To ensure the oven shelves operate safely, correct placement of the shelves between the side rails is imperative. Shelves and the pan only can be used between the first and fifth layers.

The shelves should use with the right direction, which will ensure that during careful removal of the shelf or tray, hot food items should not slide out.

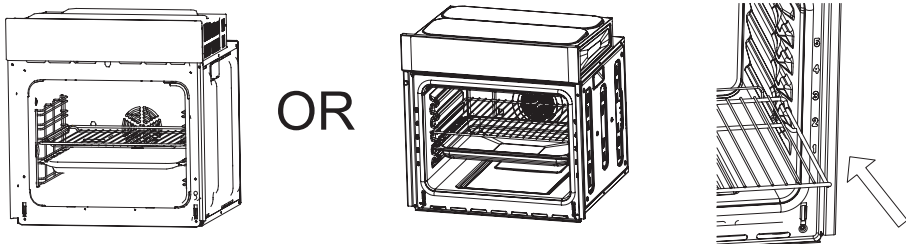

SECURING THE OVEN TO THE CABINET

1. Fit oven into the cabinet recess.
2. Open the oven door.
3. Secure the oven to the kitchen cabinet with two distance holders "A" which fit the holes in the oven frame and fit the two wood screws "B".

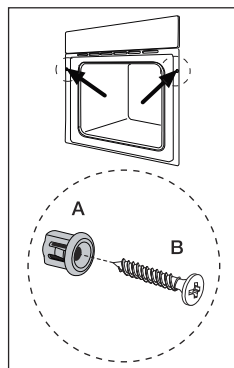

BULB REPLACEMENT

For replacement, process as follows:

- 1 > Disconnect power from the mains outlet or switch off the circuit breaker of the unit's mains outlet.
- 2 > Unscrew the glass lamp cover by turning it counter-clockwise (Note, it may be stiff) and replace the bulb with a new one of the same type.
- 3 > Screw the glass lamp cover back in place.

Note: Only use 25-40W/220V-240V, T300°C halogen lamps.

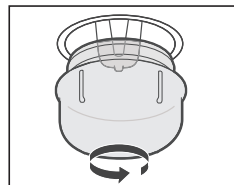

VENTILATING OPENINGS

When cooking is finished, the cavity temperature is over 70 degree. The ventilating opening will continue working for 15 minutes after the oven stop cooking.

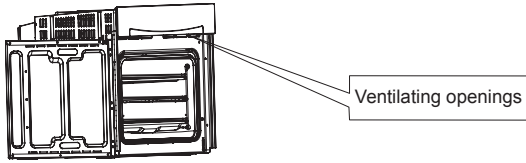

CONNECTION OF THE OVEN

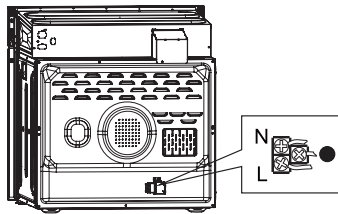

INSTALLATION

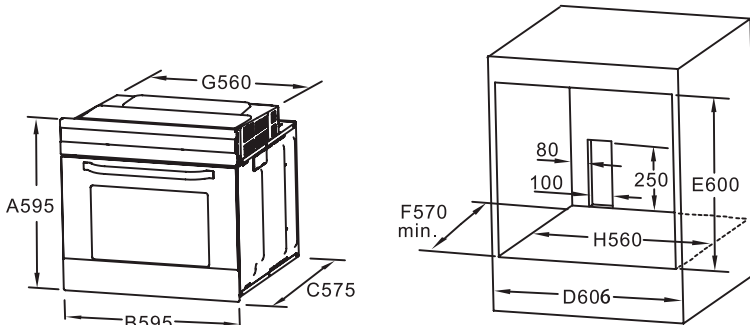

Remark:

1. The cabinet does not include the power switch or socket dimensions.

NOTE: The number of accessories included depends on the particular appliance model purchased.

REMOVING THE DOOR FROM OVEN (OPTIONAL)

Disassembly of oven door components

1. To remove the door, open the door to the maximum angle. Then pull the buckle at the door hinge backward.

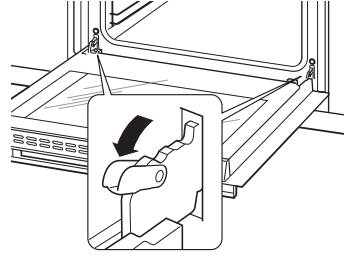

2. Close the door to an angle approximately 30°. Hold the door with one hand on each side. Lift up and slowly pull the door out from the oven.

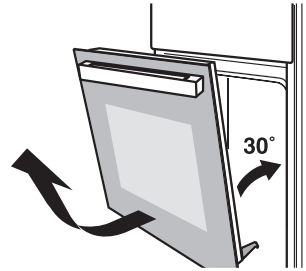

3. Open the door rotation bracket assembly. Refer the action in the following picture.

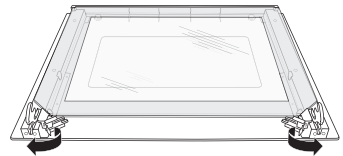

4. Lift up the inner glass door outer glass and pull it out, then take the middle glass door out in the same way.

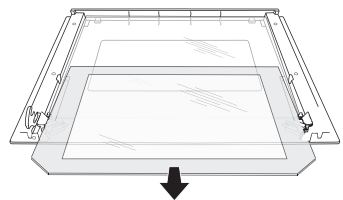

WARNING:

Don't forcibly pull out the door and take care with glass door panels during the dismantling process.

WARNING:

Ensure the hinge springs do not become loose, causing potential injury.

WARNING:

Do not lift or carry the oven door by the door handle.

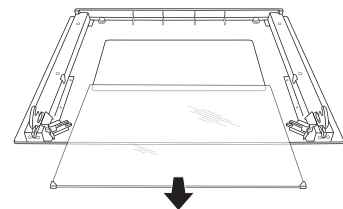

CLEANING AND MAINTENANCE

For the sake of a good appearance and reliability, keep the unit clean. The modern design of the unit facilitates maintenance to a minimum. The parts of the unit which come into contact with food have to be cleaned regularly.

- Before any maintenance and cleaning, disconnect the power.
- Set all controls in the OFF position.
- Wait until the inside of the unit is not hot but only slightly warm - cleaning is easier than that when it is warm.
- Clean the surface of the unit with a damp cloth, soft brush or fine sponge and then wipe dry. In case of heavy soiling, use hot water with non- abrasive cleaning product.
- For cleaning the glass of the oven door, do not use abrasive cleaners or sharp metal scrapers, which can scratch the surface or damage the glass.
- Never leave acidic substances (lemon juice, vinegar) on stainless steel parts.
- Do not use a high pressure cleaner for cleaning the unit . The baking pans may be washed in mild detergent.

This appliance is marked according to the European directive 2002/96/EC on Waste Electrical and Electronic Equipment (WEEE).

By ensuring this product is disposed correctly, you will help prevent potential negative consequences for the environment and human health, which could otherwise be caused by inappropriate waste handling of this product. The symbol on the product indicates that this product may not be treated as household waste. Instead it shall be handed over to the applicable collection point for the recycling of electrical and electronic equipment. Disposal must be carried out in accordance with local environmental regulations for waste disposal. For more detailed information about treatment, recovery and recycling of this product, please contact your local city office, your household waste disposal service or the shop where you purchased the product.



Maintenance schedule:

To ensure the appliance continues to operate at peak performance, we recommend a routine service call every 3 years for the life of the appliance.

FOR SPARE PARTS OR TO FIND THE ADDRESS OF
YOUR NEAREST STATE SPARE PARTS CENTRE IN AUSTRALIA

MIDEA HOME APPLIANCES AUSTRALIA PTY LTD
11/75 Lorimer Street, Docklands, Melbourne, 3008
After-sales service No.: 1800 88 60 10