

SENCOR®

SAC MT7042C/
SAC MT7043C



MOBILE AIR CONDITIONER WI-FI

Translation of the original manual



SENCOR®

**SAC MT7042C/
SAC MT7043C**

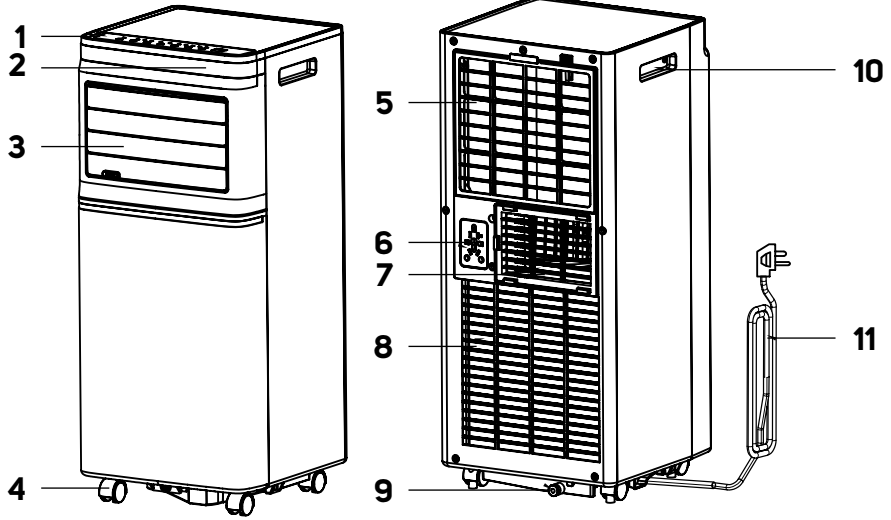
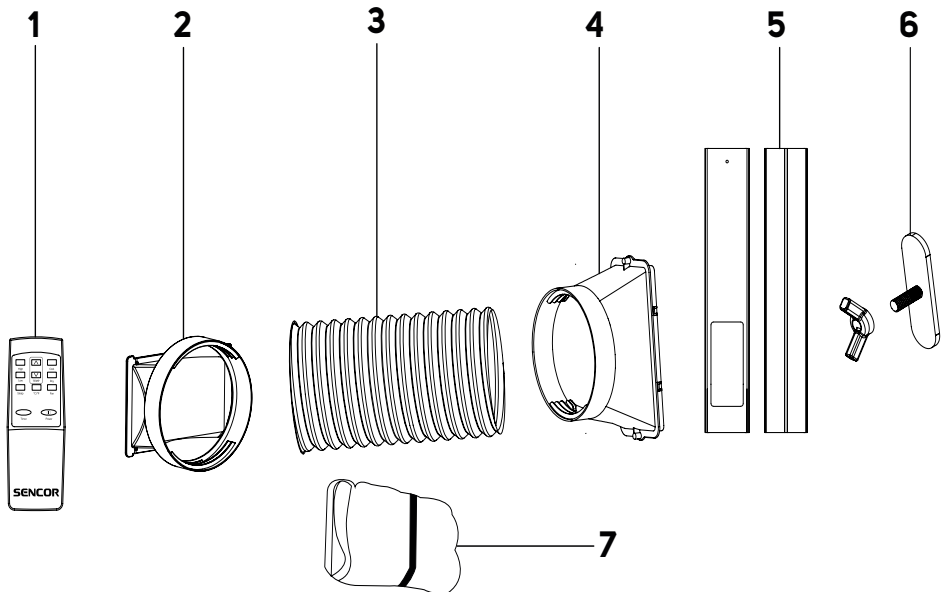

A**B**

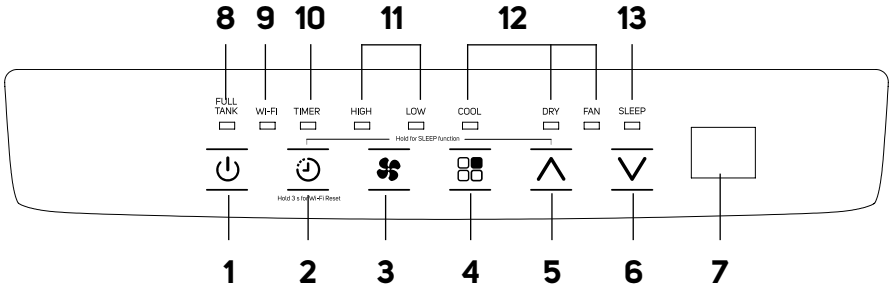
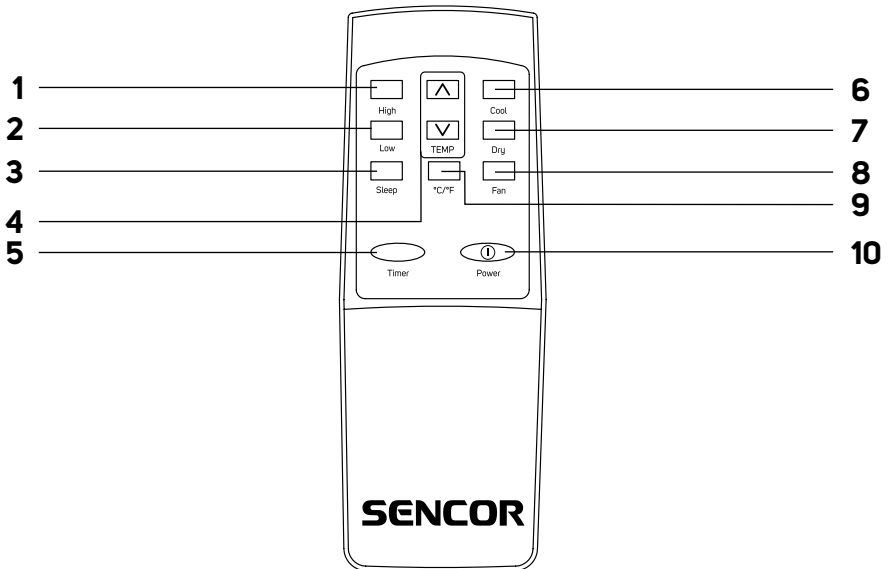
C**D**

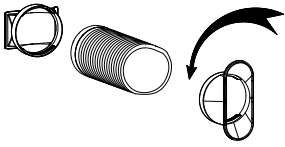
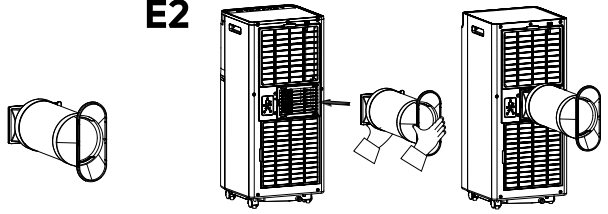
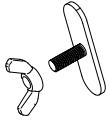
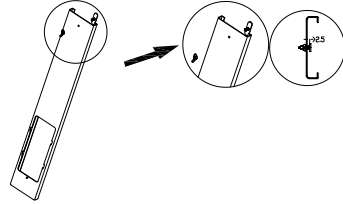
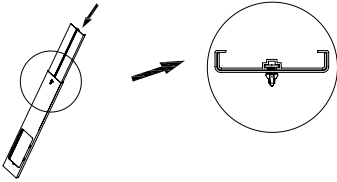
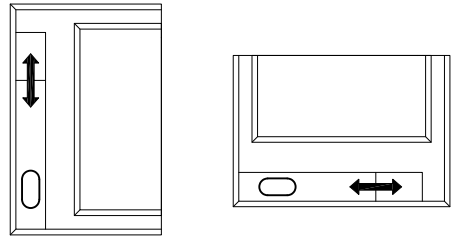
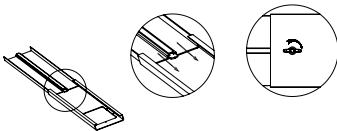
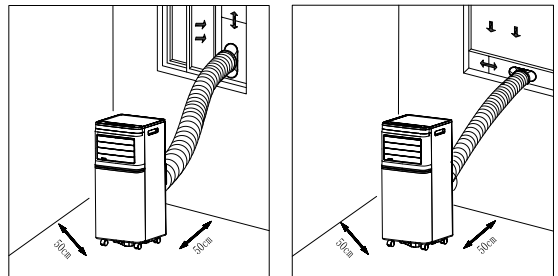
E1**E2****F1****F2****F3****F4****F5****F6**

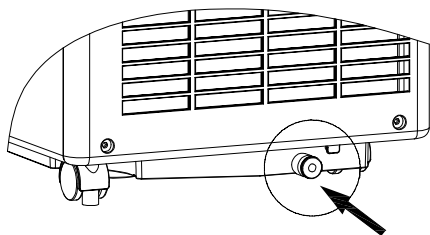
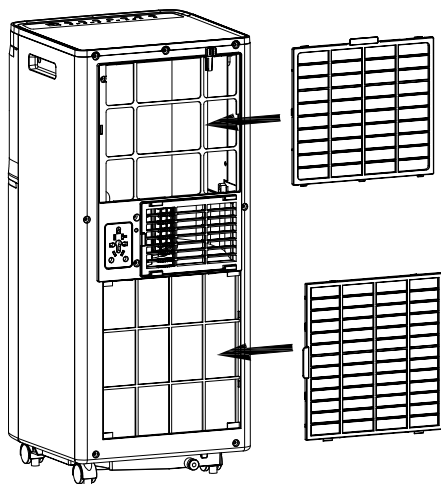
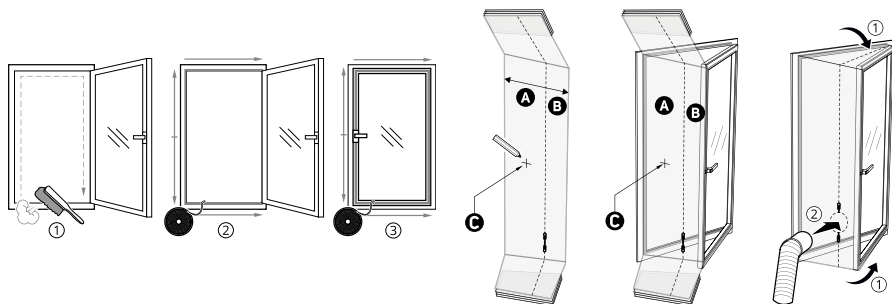
G**H****I**

Important Safety Instructions

READ CAREFULLY AND STORE FOR FUTURE USE.



This symbol means that failure to follow the instructions can cause death or serious injury.



WARNING:

In order to prevent death or injury to the user or other persons and damage to property, the following instructions must be followed. Incorrect use as a result of not following the instructions may cause death, injury or damage.

- This appliance may only be used by children aged 8 years and older and by persons with physical, sensory or mental impairments or lack of experience and knowledge, if they are supervised or have been instructed on the safe use of the appliance and understand the potential hazards. Cleaning and maintenance must not be performed by unsupervised children. Children must not play with the appliance.
- If the power cord is damaged, it must be replaced by an authorised service centre or by another similarly qualified person, this will prevent the creation of a dangerous situation. It is forbidden to use the appliance if it has a damaged power cord.

- The appliance must be stored in a manner that prevents its mechanical damage.
- The appliance must be stored in a well ventilated location, where the dimensions of the room correspond to the dimensions specified for its operation.
- The appliance must be stored in a room where an open flame is not continuously in use (e.g. running gas appliance) or where there are sources of ignition (e.g. running electrical heating element).
- Before connecting the appliance to a power socket, check that the rated voltage on its rating label matches the electrical voltage in the power socket.
- Connect the appliance only to a properly earthed socket.
- The power socket must be freely accessible so that it is possible to quickly disconnect the power cord from the power source if necessary.
- The appliance is designed for use in household, offices and similar types of areas. Do not use it in very dusty or humid rooms such as laundries or bathrooms, in areas where chemical or explosive substances are stored, in industrial surroundings or outdoors.
- Keep the appliance away from open flames or heat sources.
- Do not place the appliance on unstable surfaces such as carpets with very long and thick fibres.
- The appliance may only be used on a dry, stable, smooth and horizontal surface.
- The appliance is equipped with travel wheels so pay extra attention when handling it so that it does not fall down

stairs or travel down from sloped areas. If necessary secure the wheels using the stoppers.

- Only use original parts to assemble the appliance. Before starting to assemble the appliance, make sure that it is turned off and disconnected from the power socket.
- Prior to connecting the appliance to a power socket, make sure that the appliance is correctly assembled according to the instructions in this user's manual.
- Do not touch the appliance with wet or damp hands. This applies especially when it is connected to a power socket.
- Do not expose the appliance to dripping or splashing water or immerse it in water or other liquid.
- Do not cover or insert anything into the air inlet or air outlet openings. This could damage the appliance.
- During operation there needs to be sufficient space for air circulation of at least 50 cm on all sides of the appliance.
- Do not expose yourself to a cold air current for a long time. This could have a negative effect on your health.
- To turn the appliance on or off, always use the appropriate buttons on the control panel or the remote control. Do not turn off the appliance by disconnecting the power cord from the power socket.
- Always turn off the appliance and disconnect it from the power socket when leaving it without supervision, when not using it and before moving, disassembling or cleaning it.
- Do not attempt to remove the outer case of the appliance.

- Unplug the appliance from the power socket by pulling the plug, not the power cord. Otherwise, damage to the power cable or socket could occur.
- Do not use the appliance if damaged in any way, or with a damaged mains cable or plug.
- Store the appliance in a vertical position. It may be transported in a vertical position or tilted on the side. If you have already used the appliance, check that all the condensate has been drained. After transporting it, wait at least 1 hour before using the appliance.
- Do not use the appliance if it is not working correctly, if it has been damaged or has been submerged in water. To avoid a hazardous situation arising, do not repair the device yourself or modify it in any way. All repairs should be carried out by an authorised service centre. Tampering with the appliance may result in the loss of your legal rights regarding faulty performance or warranty for quality.
- The installation must be carried out in accordance with the installation instructions. Improper installation can result in water leaks, electric shock or fire.
- To prevent the risk of fire or electric shock, do not use this appliance with a timer or other similar device that could start this appliance spontaneously.
- The appliance must be installed in accordance with the national wiring regulations.
- Use this product only for the purposes described in this instruction manual. Otherwise, this may result in damage or excessive noise and vibration.

- Use only accessories and components that are supplied with the device and tools specifically intended for installation. The use of non-standard parts and accessories may lead to water leakage, electric shock, fire, injury or property damage.
- DO NOT adjust the length of the unit's power cord or use an extension cord to power the unit.
- DO NOT plug the unit into an outlet where other electrical appliances are already plugged in. The wrong choice of power supply may result in fire or electric shock.
- Do not cover the cord with carpet. Do not place carpets, mouldings or other coverings on the cord. Do not place the cord under furniture or appliances. Place the cord where nothing can run over or trip over it. If this occurs, immediately disconnect the unit from the socket.
- If the unit is tipped over during use, turn it off and immediately disconnect it from the main power supply. Visually inspect the unit for any damage. If you suspect that the unit has been damaged in any way, contact a technician or customer service.
- In the event of a thunderstorm, the power supply must be disconnected to prevent damage to the device caused by lightning.
- If there is a strange sound or smell or smoke, disconnect the power supply.



Read this user's manual.



A3

Warning:
Fire hazard.

SPECIFIC INFORMATION FOR APPLIANCES USING REFRIGERANT GAS R290

- Please read the warning carefully.
- For defrosting and cleaning, do not use any other tools than those recommended by the manufacturer.
- This appliance should be placed in an environment free from sources of ignition for continuous operation (e.g. open flame, gas or electric appliances).
- Do not drill or burn into the appliance.
- Refrigerant gases may be odourless.
- This appliance should be placed in rooms with an area of more than 6 m².
- This appliance contains approximately 135 g of R290 refrigerant gas.
- R290 is a refrigerant gas that meets European environmental protection directives. Do not drill holes into any part of the cooling circuit.
- The room in which this appliance is installed, operated, or stored must be such that refrigerants cannot accumulate

in the event of a leak, which could cause an explosion or fire as a result of the refrigerant igniting when electric heaters, cookers, or other sources of ignition are switched on.

- The appliance must be stored in such a manner that its mechanical damage is prevented.
- Persons working with or repairing cooling circuits must have appropriate authorisation issued by an authorised institution that certifies this person's competence to work with refrigerants in accordance with the specific assessment of the association for this sector.
- Maintenance tasks must be performed solely on the basis of the recommendations of this appliance's manufacturer. Maintenance and repair tasks that required the contribution of other qualified expert personnel may only be performed under the supervision of specialised experts in the flammable refrigerants sector.
- Check the rating label for the type of refrigerant gas used in your appliance.
- Do not cover the vents.
- Adhere to national codes relating to gas.

EXPLANATION OF SYMBOLS PLACED ON THE PRODUCT OR IN THE ACCOMPANYING DOCUMENTATION



The product meets all the basic requirements of the applicable EU directives.



This symbol on products or accompanying documents means that used electric or electronic products must not be added to ordinary municipal waste.



This symbol on the accumulator or battery means that the used battery must not be added to normal municipal waste.

- Thank you for purchasing our SENCOR product; we hope it will serve to your satisfaction.
- Before using this appliance, please familiarise yourself with the user manual, even if you are already familiar with using similar types of appliances. Use the appliance only as described in this user manual. Keep the manual for future reference.
- It is recommended to keep the original packaging, packing material, receipt and confirmation of the extent of the seller's liability or warranty certificate at least for the duration of the legal right to file defect claims or the quality warranty. When transporting the appliance, we recommend repackaging it in the original box provided by the manufacturer.







DESCRIPTION OF THE APPLIANCE

A1 Control panel	A7 Air outlet for connecting a flexible hose
A2 Decorative panel	A8 Lower air inlet protective grille with filter
A3 Air outflow	A9 Lower drain hole
A4 Castors	A10 Handles (located on both sides)
A5 Rear air inlet protective grille	A11 Power cord
A6 Power cord storage space	

DESCRIPTION OF ACCESSORIES

B1 Remote control	connection
B2 Adapter for connection to the air outlet	B5 Window insert
B3 Flexible air exhaust hose	B6 Wing nut
B4 Adapter for window	B7 Textile window seal kit

DESCRIPTION OF THE CONTROL PANEL

C1  On/Off button	C8 Full reservoir indicator light
C2  button to set the timer	C9 Wi-Fi indicator light
C3  button to adjust fan speed	C10 Timer indicator light
C4  button to select the operating mode	C11 Fan speed indicator lights (high/low)
C5  button	C12 Operating mode indicators (cooling/dehumidifier/fan)
C6  button	C13 Sleep mode indicator
C7 Display	

REMOTE CONTROL

D1 High speed button	D6 COOL button
D2 Low speed button	D7 DRY button
D3 SLEEP button to set the sleep mode	D8 FAN button
D4 TEMP buttons	D9 °C/°F button
D5 TIMER button to set the timer	D10 POWER button for switching on/off

INSTALLATION

Installation Location for the Mobile Air Conditioner

- Remove the mobile air conditioner from the packaging and make sure that you have removed all parts and accessories. We recommend that two adults remove the mobile air conditioner from the package.

- Locate the mobile air conditioner on an even, dry and stable surface and within reach of a grounded power socket. Do not place it on an unstable or inclined surface from which the mobile air conditioner could slide, fall, become damaged or lead to injury.
- The mobile air conditioner must be located in such a way that it is not exposed to direct sunlight.
- Check that there are no heat sources (e.g. heating, portable heaters, stoves, etc.) in the vicinity of the place where the mobile air conditioner will be located.
- The mobile air conditioner is equipped with castors that facilitate handling. Do not use the castors if you need to move the air conditioner on a carpet or similar surface. Avoid running over objects.
- For optimum efficiency, maintain a minimum distance of 50 cm from walls or other obstacles.
- Place the mobile air conditioner at a sufficient distance from curtains, drapes or blinds.
- Make sure that the drain hose does not touch any objects.



Note:

Do not use the mobile air conditioner to cool a room with computer servers, etc. Installation, adjustment, maintenance and repair must only be carried out by a qualified person.

Installation of the Flexible Hose for the Mobile Air Conditioner

- The flexible hose must be connected to the mobile air conditioner and installed in the window in accordance with the operating mode you want to set. Install the flexible hose if you want to select the operating modes: cooling or sleeping. The flexible hose does not need to be installed if you want to set the fan or dehumidification mode.
1. Stretch the flexible hose to the required length.
 2. Attach the adapter for connection to the outlet to one end of the flexible hose and screw it counterclockwise. Attach the adapter for connection to the window to the other end of the flexible hose and screw it counterclockwise – see Figure **E1**.
 3. Place the flexible hose onto the air outlet and insert it into the air outlet – see Figure **E2**.

Installation of the Flexible Hose in a Sliding Window

- The window insert is designed to be compatible with most sliding windows (both vertical and horizontal). Nonetheless, for certain types of sliding windows it may be necessary to modify the installation procedure described below.
1. Unscrew the wing nut – see Figure **F1**.
 2. Insert the screw from below into the main panel of the window insert, fit the washer and screw the wing nut – see Figure **F2**. However, do not tighten the nut tightly, leave a free space of about 2.5 cm.
 3. Insert the additional panel into the main panel of the window insert – see Figure **F3**. When inserting the additional panel, make sure that the lower part of the wing nut fits into the groove in the additional panel.
 4. Set the desired length/width of the window insert according to the window into which you will install it – see Figure **F4**. Tighten the wing nut to fix the length of the window insert – see Figure **F5**.
 5. Open the sliding window sash and place the window insert into the opening.
 6. Carefully close the sliding window sash. Hold the window insert in place with one hand to ensure it remains secure.
 7. Install the flexible hose with the adapter in place into the opening in the window insert – see Figure **F6**.



Note:

If necessary, cut off part of the window insert if the window is too small.

Installation of the Flexible Hose Using Textile Seal

- The textile seal is suitable for tilt, casement, or roof windows. The textile seal is equipped with a Velcro tape, which makes it easier to install the seal in the window. Open the window and install the textile seal in the resulting gap. We recommend that you properly degrease the area where you will be attaching the textile seals with a suitable product. Remove the protective paper from the tape and stick the tape to the window frame.
- In order to insert the flexible hose, the seal is equipped with an integrated zipper. Open the zipper in such a place that you can easily insert a flexible hose into the opening.
- It is not necessary to remove the textile seal from the window if you do not use the mobile air conditioner. The window can also be closed with the seal installed.



Note:

When installing, avoid excessive bending of the hose. To ensure proper operation of the mobile air conditioner, it is important that you do not overload or bend the hose unnecessarily. Excessive load or bending may damage the hose.

Installation of the Sleeve

- Open the window. Clean dust and grease from the window frame and pane in locations where the Velcro tape is to be installed. Stick the Velcro part and the sleeve part according to the diagram in Figure 1.



COMMISSIONING

- Check that the mobile air conditioner is correctly assembled and that the flexible hose is properly attached in accordance with the instructions above.
- Make sure that the mobile air conditioner is located in a suitable place at sufficient distance from the power socket.
- Insert the power plug into a properly grounded power socket.
- The mobile air conditioner will switch to the stand-by mode.

CONTROLS OF THE MOBILE AIR CONDITIONER

A. CONTROL PANEL

Mobile Air Conditioner On/Off

- Press the  button briefly and the mobile air conditioner will switch on and start by default.
- Press the  button again to switch the mobile air conditioner off and into standby mode. To switch off completely, disconnect the plug from the power socket.



Warning:

Do not turn on the mobile air conditioner immediately after it is turned off. Wait a few minutes before switching on again. Otherwise, the compressor could be damaged.







Note:

Never switch off the mobile air conditioner by unplugging the power cord from the power socket. Turn off the mobile air conditioner with the  button, wait several minutes and then disconnect the power cord.

OPERATING MODES



1. Cooling Mode

- Press the  button repeatedly until the **COOL** indicator lights up on the control panel.
- Use the  buttons to set the desired temperature. You can set the temperature in the range from 17 to 30 °C.
- Press the  button to adjust the fan speed. Press the  button repeatedly to switch the speed in the following order: High – Low. Each time the button is pressed, the respective indicator will also be lit on the control panel.

2. Dehumidifier Mode

- Press the  button repeatedly until the **DRY** indicator lights up on the control panel.
- The humidity in the room is reduced in this mode. Condensed moisture accumulates in the reservoir. Methods of condensate drainage can be found in the chapter **"CONDENSATE DRAIN"** in the next part of the user's manual.
- In this mode it is not possible to set the temperature or the speed of the fan. The fan speed is automatically set to low speed.

3. Fan Mode



- Press the  button repeatedly until the **FAN** indicator lights up on the control panel.
- In this mode, the fan will circulate the air in the room, but will not cool it.
- Press the  button to adjust the fan speed. Press the  button repeatedly to switch the speed in the following order: High – Low. Each time the button is pressed, the respective indicator will also be lit on the control panel.

MOBILE AIR CONDITIONER FUNCTIONS





1. Timer Functions

- The mobile air conditioner allows you to set two different timers – the on timer and the off timer of the mobile air conditioner.

a) Timer for Turning On the Mobile air conditioner

- The timer for turning on the mobile air conditioner allows you to activate it after a set period.
- While the mobile air conditioner is in standby mode, press the  button. The numeric display will start blinking, and the timer indicator lights up.
- Use the  buttons to set the time after which the air conditioner should turn on. The time can be set in a range from 1 to 24 hours, in 1-hour increments.
- Wait approximately 5 seconds for the time to be saved in memory. The countdown for the set time will then begin automatically.
- Once the set time has elapsed, the air conditioner will start in the last operating mode.



b) Timer for Turning Off the Mobile air conditioner

- The timer for turning off the mobile air conditioner allows you to deactivate it after a set period.
- While the mobile air conditioner is running, press the  button. The numeric display will start blinking, and the timer indicator lights up.
- Use the  buttons to set the time after which the air conditioner should turn off. The time can be set in a range from 1 to 24 hours, in 1-hour increments.
- Wait approximately 5 seconds for the time to be saved in memory. The countdown for the set time will then begin automatically.
- Once the set time has elapsed, the air conditioner will turn off and switch to standby mode.
- If you need to switch off the appliance, press the  button. The remaining countdown time will flash. Press the  button again and the timer will be canceled.

2. Sleep Timer

- The sleep timer is used to reduce energy consumption during the night when a constant temperature is not required. The function also

ensures comfort during sleep, as the operation of the air conditioner is muted and the display light is dimmed.

- Select the cooling mode and set the default temperature. Then press the  and  buttons simultaneously to activate the sleep function.
- The fan speed is automatically set to low.
- The sleep function cannot be set in the fan and dehumidifier modes.

B. REMOTE CONTROL

Inserting and Replacing Batteries

- Slide out the battery compartment cover, which is located on the rear side of the remote control. Place 2 AAA/LR03 (2 x 1.5 V) alkaline batteries into the battery compartment and close the cover.
- When inserting the batteries ensure the correct polarity as shown in the battery compartment.
- When replacing batteries, always use new batteries of the same type, never combine old and new batteries or batteries of various types.



Note:

Taking the batteries out of the remote control will delete all the settings. After new batteries are inserted the default remote control setting as programmed by the manufacturer will be renewed.

- If you will not be using the remote control for longer than 2 months, remove the batteries.



Caution:

Dispose of used batteries in accordance with local regulations. Do not throw batteries into mixed household waste. Do not use old and new batteries at the same time. Do not use alkaline, standard or rechargeable batteries at the same time. Do not throw the batteries into a fire. They might explode or electrolyte might leak.

Using the remote control

- For the remote control to work properly, make sure that the maximum distance between the control and the mobile air conditioner does not exceed 8 m and that there is no obstacle between the control and the mobile air conditioner that could prevent signal transmission.
- Point the remote control directly at the mobile air conditioner. The signal transmission is confirmed by a short sound signal.
- Do not expose the remote control to direct sunlight or high temperatures. Otherwise the signal may not be transmitted.

Mobile air conditioner On/Off

- Press the **POWER** button briefly and the mobile air conditioner will switch on and start by default.
- Press the **POWER** button again to switch the mobile air conditioner off and into standby mode. To switch off completely, disconnect the plug from the power socket.



Warning:

Do not turn on the mobile air conditioner immediately after it is turned off. Wait a few minutes before switching on again. Otherwise, the compressor could be damaged.



Note:

Never switch off the mobile air conditioner by unplugging the power cord from the power socket. Turn off the mobile air conditioner with the **POWER** button, wait several minutes and then disconnect the power cord.

OPERATING MODES

1. Cooling Mode

- Press the **COOL** button.
- Use the  buttons to set the desired temperature. You can set the temperature in the range from 17 to 30 °C.

- Use the **HIGH/LOW** buttons to set the fan speed, **HIGH** for high speed, **LOW** for low speed.

2. Dehumidifier Mode

- Press the **DRY** button.
- The humidity in the room is reduced in this mode. Condensed moisture accumulates in the reservoir. Methods of condensate drainage can be found in the chapter "**CONDENSATE DRAIN**" in the next part of the user's manual.
- In this mode it is not possible to set the temperature or the speed of the fan. The fan speed is automatically set to low speed.

3. Fan Mode

- Press the **FAN** button.
- In this mode, the fan will circulate the air in the room, but will not cool it.
- Use the **HIGH/LOW** buttons to set the fan speed, **HIGH** for high speed, **LOW** for low speed.

MOBILE AIR CONDITIONER FUNCTIONS

1. Timer Functions

- The mobile air conditioner allows you to set two different timers – the on timer and the off timer of the mobile air conditioner.

a) Timer for Turning On the Mobile air conditioner

- The timer for turning on the mobile air conditioner allows you to activate it after a set period.
- While the mobile air conditioner is in standby mode, press the **TIMER** button. The numeric display will start blinking, and the timer indicator lights up.
- Use the  buttons to set the time after which the air conditioner should turn on. The time can be set in a range from 1 to 24 hours, in 1-hour increments.
- Wait approximately 5 seconds for the time to be saved in memory. The countdown for the set time will then begin automatically.
- Once the set time has elapsed, the air conditioner will start in the last operating mode.

b) Timer for Turning Off the Mobile air conditioner

- The timer for turning off the mobile air conditioner allows you to deactivate it after a set period.
- While the mobile air conditioner is running, press the **TIMER** button. The numeric display will start blinking, and the timer indicator lights up.
- Use the  buttons to set the time after which the air conditioner should turn off. The time can be set in a range from 1 to 24 hours, in 1-hour increments.
- Wait approximately 5 seconds for the time to be saved in memory. The countdown for the set time will then begin automatically.
- Once the set time has elapsed, the air conditioner will turn off and switch to standby mode.
- If you need to cancel the timer, press the **TIMER** button. The remaining countdown time will flash. Press the **TIMER** button again and the timer will be cancelled.

2. Sleep Timer

- The sleep timer is used to reduce energy consumption during the night when a constant temperature is not required. The function also ensures comfort during sleep, as the operation of the air conditioner is muted and the display light is dimmed.
- Select the cooling mode and set the default temperature. Then press the **SLEEP** button to turn on the sleep function.
- The fan speed is automatically set to low.
- The sleep function cannot be set in the fan and dehumidifier modes.

Changing Temperature Units

- Press the °C/°F button to change the temperature units from °C to °F and vice versa.

C. OPERATION VIA SENCOR HOME APP

- This mobile air conditioner can be controlled via the Sencor HOME app.
- Download the application to your smartphone, register and control your portable air conditioning via the application.



- If you already have the app installed, add portable air conditioning to your devices.

Adding the Mobile air conditioner to the Device List via Bluetooth

- You can add the mobile air conditioner to the Sencor HOME app by pairing via Bluetooth.
1. Switch on the Bluetooth function on your mobile phone.
 2. Switch on the mobile air conditioner.
 3. Open the app and on the app's home page, click the "+" icon.
 4. The device itself will offer the "Do not add / Go to add" options.
 5. Click on "Go to add" and the app will automatically guide you through the addition.



Note:

If the Bluetooth connection fails or is not possible, make sure there are no solid obstacles between your phone and the mobile air conditioner and that the two devices are close together.

Adding the Mobile air conditioner to the Device List via QR Code

- The mobile air conditioner can also be added to the Sencor HOME app using the QR code provided below. On the home screen of the application, click on the "+" icon and on the Add device screen, click on the [-] icon in the top right corner.

QR Code for Adding the Control Panel of the Mobile air conditioner to the Sencor HOME App



Manually Adding the Mobile air conditioner to the Device List

- On the main screen, click "Add Device" or the "+" icon in the top right corner.
- A screen with appliance categories and a list of appliances will appear.
- Click "Cooling" and select the mobile air conditioner model from the list of products.
- On the next screen, you will be prompted to select a Wi-Fi network. Select the network, enter your password and click "Next".
- Check that the mobile air conditioner is ready for pairing. It is important that the mobile air conditioner is connected to a power source and is in stand-by mode. The Wi-Fi indicator will flash quickly on the control panel. If the indicator does not flash, press and hold the  button for 3 seconds until the Wi-Fi indicator flashes rapidly. In the app, confirm that the Wi-Fi indicator is blinking rapidly and click "Next".
- The mobile air conditioner is automatically added to the device list. The Wi-Fi indicator will turn on.
- In the device list on the main screen, click on the mobile air conditioner icon to access the mobile air conditioner controls.

Wi-Fi reset

- Press the  button for 3 seconds while the mobile air conditioner is in operation. The Wi-Fi settings will be reset and the Wi-Fi indicator will blink rapidly (twice per second).

CONDENSATE DRAIN OUTLET

- The mobile air conditioner is equipped with two drain holes, each of which drains condensate from a different part of the air conditioner. If the mobile air conditioner is used frequently, the condensate must be regularly checked and drained. If you select the dehumidifier operating mode, we recommend draining the condensate using a drain hose that you connect to the upper drain hole.



Note:

In cooling and fan operation modes (assuming low humidity in the room) it may not be necessary to drain the condensate. The mobile air conditioner is designed to increase its efficiency with a small amount of water in the condensate reservoir.

Condensate Outlet from the Lower Drain Hole

- If the water level in the reservoir reaches a predetermined level, the mobile air conditioner will stop running, an audible warning will sound and the full reservoir indicator light will illuminate. To drain the condensate from the air conditioner, proceed as follows:
1. Unplug the power cord from the power socket.
 2. Carefully move the mobile air conditioner to the drain point.
 3. Place a container under the lower drain hole into which the condensate will flow – see Figure G. Carefully remove the drain plug. If necessary, connect the drain hose and allow the condensate to drain. You can tilt the mobile air conditioner slightly backwards during draining the condensate.
 4. As soon as the reservoir is empty (condensate has stopped flowing), disconnect the drain hose, if used, and replace the drain plug. Before switching on the mobile air conditioner again, check that the drain plug is correctly inserted and seals well. Otherwise, condensate may leak during operation and damage the floor or carpet.
 5. Plug the power cord into the power socket and the mobile air conditioner will automatically resume operation.



Note:

If you turn off the mobile air conditioner with the  button, its operation will not automatically resume and it will be necessary to set it again.



Note:

If the mobile air conditioner is added to the list of devices in the Sencor HOME application, the full reservoir warning will also appear directly in the application, as well as other warning messages.

Continuous drainage

1. Unplug the power cord from the power socket.
2. Remove the drain plug. Connect the drain hose. If the length of the drain hose is not sufficient, it will be necessary to purchase a longer hose of the same type. Never extend the drain hose by adjusting it.
3. Connect the end of the drain hose to the drain hole.
4. Unplug the power cord into the power socket and switch on the mobile air conditioner.



Note:

The drain hose should be installed at the same height or lower than the drain hole. Otherwise, the condensate will not drain properly from the reservoir.

SAFETY PROTECTION ELEMENTS

Audible Warning and Shutoff When Reservoir is Full

- If the water level in the reservoir reaches a predetermined level, the mobile air conditioner will stop running, an audible warning will sound and the full reservoir indicator light will illuminate.
- The condensate reservoir must be emptied. Follow the instructions in the “CONDENSATE DRAIN” section.

Protection of the Compressor

- The compressor is equipped with a time protection against damage when switching on again for a period of 3 minutes. If the mobile air conditioner is switched on shortly after it is switched off, the operation of the compressor will start only after 3 minutes.

Room and Coil Temperature Sensor Malfunction

1. Detects sensor malfunction when switched on or in operation.
2. When a fault is detected when switching on, it immediately puts the mobile air conditioner in an error state. If it returns to normal during this time, the mobile air conditioner will switch to the standby mode.

TIPS FOR PROPER USE

- To ensure that the mobile air conditioner works correctly, we recommend that you observe the following:
 - Close all windows and doors of the room where the mobile air conditioner is used. If you have installed a mobile air conditioner in a room only temporarily, you can leave the door slightly ajar (about 1 cm) to ensure proper ventilation.
 - Prevent direct sunlight from entering the room. Close the curtains or blinds to ensure economical operation of the air conditioner.
 - Do not block the air outlet and inlet openings.
 - Check that there is no heat source turned on in the room.
 - Never use the mobile air conditioner in an excessively humid environment, such as in laundries.
 - Never use the mobile air conditioner outdoors.
 - Check that the mobile air conditioner is located on a flat surface. If necessary, install special brakes on the castors.

MAINTENANCE AND CLEANING

- Before cleaning, turn off the mobile air conditioner, wait several minutes and then disconnect the power cord from the power socket.

Cleaning the Protective Grilles and Air Filters

- When using the mobile air conditioner regularly, clean the protective grilles and air filters at least once every two weeks to prevent dust from clogging the fan.
- Carefully remove the protective grilles and remove the filters – see Figure H. Use a vacuum cleaner to remove dust from the grilles and filters.
- In case of heavy soiling, wash the filter by hand in a solution of lukewarm water (max. 40°C) and neutral detergent. Then thoroughly rinse under flowing water and allow to dry naturally. Do not dry it in a clothes dryer or in direct sunlight. Once the filters are dry, you can install them back in their place.
- In case of heavier soiling, you can wipe the protective grilles with a slightly damp cloth and then wipe them dry with a clean cloth.



Note:

Do not use mobile air conditioning without properly installed air filters and protective grilles. Never install wet or damp air filters and protective grilles in mobile air conditioners.

Cleaning the outer casing

- To clean the outer case, use a soft wiping cloth dipped in a solution of lukewarm water and neutral detergent. Then wipe the surface dry.
- When cleaning, do not spray water or any other liquid on the mobile air conditioner, do not water it or submerge it in water or in any other liquid.
- Do not use abrasive cleaning products, solvents, petrol, etc. for cleaning.

Mobile air conditioner Storage

- Keep the mobile air conditioner running in a heated room in fan mode for about 12 hours to dry it out and prevent mould.
- Disconnect the flexible hose and store it in a safe place out of the reach of children.
- Drain all condensate from the reservoir – see the chapter “CONDENSATE DRAIN”.
- Clean the air filters and reattach them. Wipe the outer case of the mobile air conditioner. Remove the batteries from the remote control.
- Store the air conditioner in a cold, dry and dark location.

Recommissioning

- Make sure that the power cord and plug are not damaged and the air filters are clean. Insert new batteries in the remote control. Follow the instructions in the **Inserting and Replacing Batteries** section. Install the mobile air conditioner according to the guidelines provided in the previous section of the manual, “Installation”.

TROUBLESHOOTING

- Before contacting an authorised service centre, check this equipment by following these instructions:

Problem	Possible cause	Troubleshooting
The mobile air conditioner did not switch on.	The supply cable is not connected to the power socket, or the power socket is not under voltage.	Plug the plug properly into the power socket, or check that the socket is live.
	The condensate reservoir is full.	Empty the reservoir according to the instructions in the “CONDENSATE DRAIN” section.
	The ambient temperature is too low or high.	We recommend using a mobile air conditioner at temperatures from 5°C to 35°C.
	The temperature in the room is lower than the set temperature (cooling operating mode).	Adjust the set temperature.
The mobile air conditioner is not cooling sufficiently.	The mobile air conditioner is exposed to direct sunlight.	Move the mobile air conditioner or shade it.
	The windows and doors of the room are open and warm air flows into the room or the heat sources are switched on in the room.	Ensure that all windows and doors are closed, or turn off heat sources.
	The air filter is dirty.	Switch off the air conditioner and clean the air filter according to the instructions in “Cleaning the Air Filter”.
	Air inlet or outlet openings are blocked.	Remove the cause of the blockage.
The mobile air conditioner is too loud.	The air conditioner is placed on an uneven surface.	Turn off the air conditioner, unplug the power cord from the power socket and move it to a flat and level place.
The compressor is not working.	Overheating protection has been activated.	Wait 3 minutes until the temperature drops. After that, operation is automatically resumed.

The remote control doesn't work.	The distance between the control and the mobile air conditioner is too large.	Approach the mobile air conditioner and make sure that there are no obstacles between the control and the mobile air conditioner.
	The remote control does not point at the signal sensor.	
	The batteries are flat.	Replace the batteries.

* This is the conversion of the value to the climatic conditions typical for Central Europe. For an ordinary room with a standard height ceiling. Values may vary if used in rugged areas, areas with multiple heat sources, heavily glazed and/or poorly insulated areas. If you know that you are buying a mobile air conditioner for a space with the above described properties, choose a model with a higher power for the given area.

The declared noise emission value of the appliance is 64/61 dB (A), which is the A sound pressure level relative to a reference sound power of 1 pW.

Error Messages

Display	Meaning	Solution
E1	Room temperature sensor malfunction	Contact an authorised service centre.
E2	Temperature tube sensor malfunction	Contact an authorised service centre.
The full reservoir indicator light has turned on.	Condensate reservoir is full.	Empty the reservoir according to the instructions in the "CONDENSATE DRAIN" section.



Note:

If any of the above malfunctions occur, turn off the mobile air conditioner and check the cause of the malfunction. Turn it on again, and if this fault occurs again, turn it off, disconnect the power cord from the power socket and contact the manufacturer, an authorised service centre or a person with appropriate qualifications and entrust them with the repair of the fault.



Note:

The efficiency of the mobile air conditioner may be reduced if it is used outside the range of operating temperatures listed above.

DISPOSAL OF USED BATTERIES

Batteries contain environmentally damaging compounds and therefore do not belong in standard municipal waste. Take used batteries for proper disposal at a designated battery collection point.

SENCOR hereby declares that the SAC MT7042C radio device conforms to the 2014/53/EU directive. The full text of the Declaration of Conformity can be found at www.sencor.eu.

INSTRUCTIONS AND INFORMATION ON DISPOSAL OF USED PACKAGING MATERIAL

Dispose of used packaging material at the designated municipal waste disposal site.

TECHNICAL SPECIFICATIONS

Power supply	220–240 V~ / 50 Hz
Cooling power output	7,000 BTU/hour
Cooling power consumption	760 W
Current consumption	3.4 A
EER cooling factor	2.6
Dehumidification capacity	20 l/day
Capacity of the built-in condensate reservoir	0,7 l
Coolant type and weight	R290 / 135 g
Air flow volume	300 / 220 m ³ /hour (high/low)
Sound pressure level	64/61 dB (A) (high/low)
Sound power level	55/52 dB (A) (high/low)
Maximum permissible value of operating pressure (low/high):	2/2,6 MPa
Dimensions of the mobile air conditioner (W × D × H)	300 × 294 × 695 mm
Weight	18.7 kg
Operating temperature (cooling)	17 to 30 °C
Recommended room area (Central Europe)*	21–26 m ²
Recommended room size (Central Europe)*	54–67 m ³
Maximum room size	26 m ² / 67 m ³ (ceiling height 2.6 m)

Wireless technology used	Wi-Fi: IEEE 802.11 B/G/N20 support
	Bluetooth: Bluetooth 4.2 Low Energy

DISPOSAL OF USED ELECTRICAL AND ELECTRONIC EQUIPMENT

Used electrical and electronic products must not be disposed of in ordinary municipal waste. To enable the proper disposal, renewal and recycling of these products, deliver them to the designated collection points. Alternatively, in some European Union states or other European countries the products can be returned to the local retailer when buying an equivalent new product. By disposing of this product correctly, you help to conserve valuable natural resources and prevent any potential adverse impact on the environment and human health that could result from improper waste disposal. For more details, contact your local authority or nearest collection point. Fines may be imposed for the improper disposal of this type of waste as per national regulations.

For business entities in European Union States

If you wish to dispose of electrical and electronic equipment, please request the necessary information from your retailer or supplier.

Disposal in other countries outside the European Union

To dispose of this product elsewhere, request the necessary information on the correct disposal method from local authorities or your retailer.

Changes to text and technical parameters are reserved.