



# User Guide

AC750 Wireless Dual Band Router  
Archer C20



# Contents

About This Guide .....	1
<b>Chapter 1. Get to Know About Your Router .....</b>	<b>2</b>
1. 1. Product Overview.....	3
1. 2. Panel Layout.....	3
1. 2. 1.Top View .....	3
1. 2. 2.The Back Panel.....	4
<b>Chapter 2. Connect to the Internet .....</b>	<b>6</b>
2. 1. Position Your Router .....	7
2. 2. Connect Your Router.....	7
<b>Chapter 3. Log In to the Router .....</b>	<b>10</b>
<b>Chapter 4. Configure the Router in Wireless Router Mode .....</b>	<b>12</b>
4. 1. Network Map .....	13
4. 2. Operation Mode .....	15
4. 3. Network .....	16
4. 3. 1.Status.....	16
4. 3. 2.Change the Internet Settings.....	18
4. 3. 3.Change the LAN Settings.....	20
4. 3. 4.Configure to Support IPTV Service .....	20
4. 3. 5.Specify DHCP Server Settings .....	22
4. 3. 6.Set Up a Dynamic DNS Service Account.....	24
4. 3. 7.Static Routing .....	26
4. 4. TP-Link Cloud Service .....	29
4. 4. 1.Register a TP-Link ID .....	29
4. 4. 2.Change Your TP-Link ID Information .....	29
4. 4. 3.Manage the User TP-Link IDs.....	31
4. 4. 4.Manage the Router via the TP-Link Tether App.....	32
4. 5. EasyMesh with Seamless Roaming.....	32
4. 6. Wireless Settings.....	36
4. 6. 1.Specify Wireless Settings .....	36
4. 6. 2.Guest Network .....	39
4. 6. 3.IoT Network.....	41

4. 6. 4.	Wireless Schedule .....	42
4. 6. 5.	WPS.....	43
4. 6. 6.	Advanced Wireless Settings.....	45
4. 7.	NAT Forwarding.....	46
4. 7. 1.	Share Local Resources on the Internet by Port Forwarding.....	46
4. 7. 2.	Open Ports Dynamically by Port Triggering .....	48
4. 7. 3.	Make Xbox Online Games Run Smoothly by UPnP.....	50
4. 7. 4.	Make Applications Free from Port Restriction by DMZ.....	51
4. 8.	Parental Controls .....	52
4. 9.	QoS .....	55
4. 10.	Network Security .....	55
4. 10. 1.	Protect the Network from Cyber Attacks .....	56
4. 10. 2.	Access Control .....	56
4. 10. 3.	IP & MAC Binding .....	59
4. 10. 4.	ALG.....	61
4. 10. 5.	IoT Security.....	61
4. 11.	IPv6 .....	62
4. 12.	Smart Life Assistant .....	65
4. 13.	Manage the Router .....	67
4. 13. 1.	Firmware Update.....	67
4. 13. 2.	Backup and Restore Configuration Settings .....	69
4. 13. 3.	Change Password.....	71
4. 13. 4.	Local Management .....	71
4. 13. 5.	Remote Management .....	72
4. 13. 6.	HTTP Referer Head Check .....	74
4. 13. 7.	System Log.....	75
4. 13. 8.	CWMP Settings.....	75
4. 13. 9.	Diagnostics.....	77
4. 13. 10.	Set System Time and Language .....	78
4. 13. 11.	Reboot & Reboot Schedule .....	81
4. 13. 12.	Control the LED .....	82

## **Chapter 5. Configure the Router in Access Point Mode .....** 83

5. 1.	Network Map .....	84
5. 2.	Operation Mode .....	85
5. 3.	Network .....	86
5. 3. 1.	LAN Settings.....	86
5. 3. 2.	DHCP Server Settings.....	87

5. 3. 3.	Access Control	89
5. 4.	Wireless Settings	91
5. 4. 1.	Specify Wireless Settings	91
5. 4. 2.	Guest Network	94
5. 4. 3.	IoT Network	95
5. 4. 4.	Wireless Schedule	96
5. 4. 5.	WPS	97
5. 4. 6.	Advanced Wireless Settings	99
5. 5.	Manage the Router	100
5. 5. 1.	Firmware Update	100
5. 5. 2.	Backup and Restore Configuration Settings	101
5. 5. 3.	Change Password	103
5. 5. 4.	Local Management	103
5. 5. 5.	HTTP Referer Head Check	105
5. 5. 6.	System Log	105
5. 5. 7.	Diagnostics	106
5. 5. 8.	Set System Time and Language	107
5. 5. 9.	Reboot & Reboot Schedule	110
5. 5. 10.	Control the LED	111

## Chapter 6. Configure the Router in Range Extender Mode ..... 112

6. 1.	Network Map	113
6. 2.	Operation Mode	114
6. 3.	Network	115
6. 3. 1.	LAN Settings	115
6. 3. 2.	DHCP Server Settings	116
6. 3. 3.	Access Control	118
6. 4.	Wireless Settings	120
6. 4. 1.	Connect to the Main Network	120
6. 4. 2.	Specify Wireless Settings	121
6. 5.	Manage the Router	122
6. 5. 1.	Firmware Update	122
6. 5. 2.	Backup and Restore Configuration Settings	124
6. 5. 3.	Change Password	125
6. 5. 4.	Local Management	126
6. 5. 5.	HTTP Referer Head Check	127
6. 5. 6.	System Log	128
6. 5. 7.	Diagnostics	128

6. 5. 8.Set System Time and Language .....	130
6. 5. 9.Reboot & Reboot Schedule .....	132
6. 5. 10.Control the LED .....	133

**Chapter 7. FAQ..... 135**



# About This Guide

This guide is a complement to Quick Installation Guide. The Quick Installation Guide provides instructions for quick internet setup, while this guide contains details of each function and demonstrates how to configure them.

Features available in the router may vary by model and software version. Router availability may also vary by region or ISP. All images, steps, and descriptions in this guide are only examples and may not reflect your actual Router experience.

## Conventions

In this guide the following conventions are used:

Convention	Description
<u>Underlined</u>	Underlined words or phrases are hyperlinks. You can click to redirect to a website or a specific section.
Teal	Contents to be emphasized and texts on the web page are in teal, including the menus, items, buttons and so on.
>	The menu structures to show the path to load the corresponding page. For example, <a href="#">Advanced</a> > <a href="#">Wireless</a> > <a href="#">MAC Filtering</a> means the MAC Filtering function page is under the Wireless menu that is located in the Advanced tab.
 <b>Note:</b>	Ignoring this type of note might result in a malfunction or damage to the device.
 <b>Tips:</b>	Indicates important information that helps you make better use of your device.

\*Maximum wireless signal rates are the physical rates derived from IEEE Standard 802.11 specifications. Actual wireless data throughput and wireless coverage are not guaranteed and will vary as a result of 1) environmental factors, including building materials, physical objects, and obstacles, 2) network conditions, including local interference, volume and density of traffic, product location, network complexity, and network overhead, and 3) client limitations, including rated performance, location, connection, quality, and client condition.

## More Info

The latest software, management app and utility can be found at [Download Center](https://www.tp-link.com/support/download/) at <https://www.tp-link.com/support/download/>.

The Quick Installation Guide can be found where you find this guide or inside the package of the router.

Specifications can be found on the product page at <https://www.tp-link.com>.

TP-Link Community is provided for you to discuss our products and share knowledge at <https://community.tp-link.com>.

Our Technical Support contact information can be found at the [Contact Technical Support](https://www.tp-link.com/support/) page at <https://www.tp-link.com/support/>.

## Chapter 1

---

# Get to Know About Your Router

---

This chapter introduces what the router can do and shows its appearance.

It contains the following sections:

- [Product Overview](#)
- [Panel Layout](#)

## 1.1. Product Overview

The TP-Link router is designed to fully meet the need of Small Office/Home Office (SOHO) networks and users demanding higher networking performance. The powerful antennas ensure continuous Wi-Fi signal to all your devices while boosting widespread coverage throughout your home, and the built-in Ethernet ports supply high-speed connection to your wired devices.

Moreover, it is simple and convenient to set up and use the TP-Link router due to its intuitive web interface and the powerful Tether app.





## 1.2. Panel Layout

### 1.2.1. Top View



The router's LEDs (view from left to right) are located on the front panel. You can check the router's working status by following the LED Explanation table.

## LED Explanation

Name	Status	Indication
 (Power)	On	The system has started up successfully.
	Slow Flashing	The system is starting up or firmware is being upgraded. Do not disconnect or power off your router.
	Quick Flashing	WPS connection is in progress (about 2 minutes).
	Off	Power is off.
 (2.4GHz Wireless)	On	The 2.4GHz wireless band is enabled.
	Off	The 2.4GHz wireless band is disabled.
 (5GHz Wireless)	On	The 5GHz wireless band is enabled.
	Off	The 5GHz wireless band is disabled.
 (Ethernet)	On	At least one Ethernet port is connected to a powered-on device.
	Off	No Ethernet port is connected to a powered-on device.
 (Internet)	Green On	Internet service is available.
	Orange On	The router's Internet port is connected, but the internet is not available.
	Off	The router's Internet port is not connected.

### 1.2.2. The Back Panel



The following parts (view from left to right) are located on the rear panel.

Item	Description
Wi-Fi/WPS Button	Press this button for 1 second, and immediately press the WPS button on your device. The Power LED of the router should change from flashing to solid on, indicating successful WPS connection.
	Press and hold this button for about 5 seconds to turn on or off the wireless function of your router.
Reset Button	Press and hold this button until all LEDs turn off to reset the router to its factory default settings.
WAN Port	For connecting to a DSL/Cable modem, or an Ethernet port.
LAN Ports (1/2/3/4)	For connecting your PCs or other wired network devices to the router.
Power On/Off Button 	Press this button to power on or off the router.
Power Port	For connecting the router to a power socket via the provided power adapter.
Antennas	Used for wireless operation and data transmitting. Upright them for the best Wi-Fi performance.

## Chapter 2

---

# Connect to the Internet

---

This chapter contains the following sections:

- [Position Your Router](#)
- [Connect Your Router](#)

## 2.1. Position Your Router

- The product should not be located in a place where it will be exposed to moisture or excessive heat.
- Place the router in a location where it can be connected to multiple devices as well as to a power source.
- Make sure the cables and power cord are safely placed out of the way so they do not create a tripping hazard.
- The router can be placed on a shelf or desktop.
- Keep the router away from strong devices with strong electromagnetic interference, such as Bluetooth devices, cordless phones and microwaves.

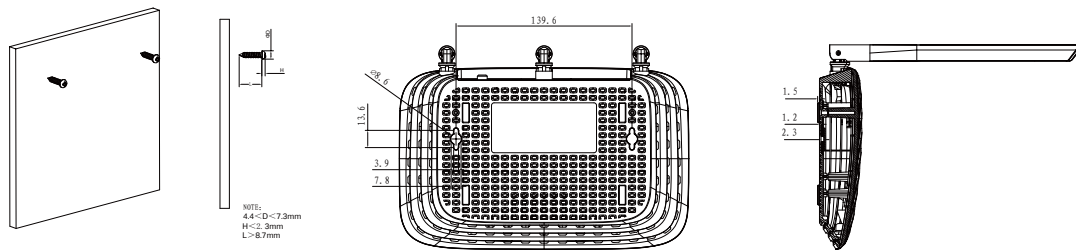

 Note:

The diameter of the screw head,  $4.4\text{mm} < D < 7.3\text{mm}$ , and the distance of two screws is 139.6mm. The screw that project from the wall need around 5mm based, and the length of the screw need to be at least 8.7mm to withstand the weight of the product.

## 2.2. Connect Your Router

This mode enables multiple users to share internet connection via ADSL/Cable Modem.

1. Follow the steps below to connect your router.

If your internet connection is through an Ethernet cable directly from the wall instead of through a DSL / Cable / Satellite modem, connect the Ethernet cable to the router's Internet port, and then follow Step 4 and 5 to complete the hardware connection.

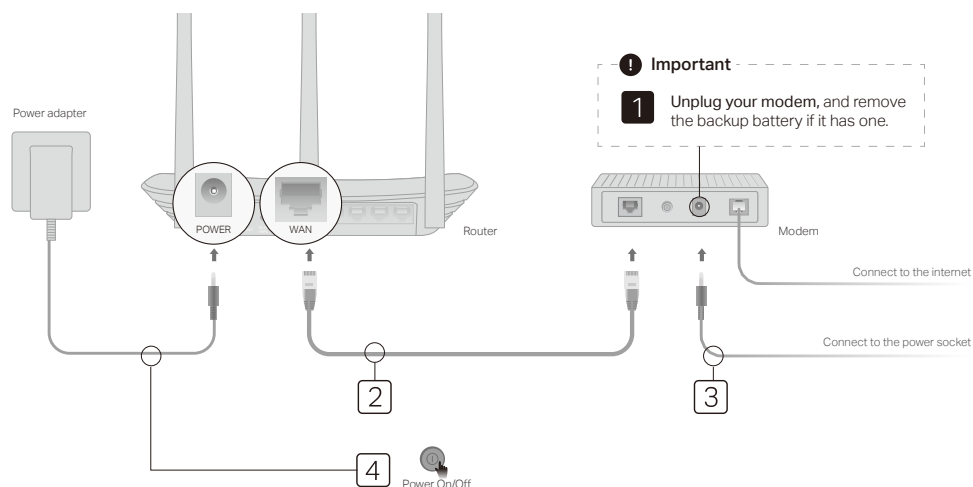

- 1) **Unplug your modem**, and remove the backup battery if it has one.
- 2) Connect the **powered-off** modem to the router's **WAN** port with an Ethernet cable.
- 3) Power on the modem and then wait about **2 minutes** for it to restart.
- 4) Connect the power adapter to the router and turn it on.
- 5) Verify that the hardware connection is correct by checking these LEDs.



#### Note:

If the 2.4GHz and 5GHz Wi-Fi LEDs are off, press and hold the Wi-Fi/WPS button on the rear panel for about 5 seconds, then release the button. Both LEDs will turn on.

## 2. Connect your computer to the router.

### • Method 1: Wired

Turn off the Wi-Fi on your computer and connect it to the router via an Ethernet cable.

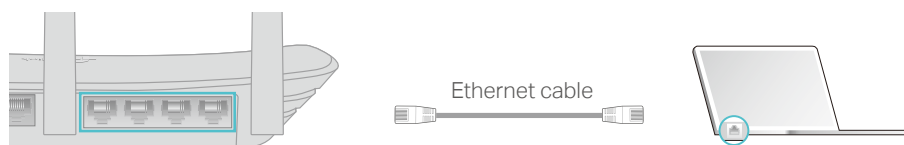

### • Method 2: Wirelessly

- 1) Find the SSID (Network Name) and Wireless Password printed on the label at the bottom of the router.

- 2) Click the network icon of your computer or go to Wi-Fi Settings of your smart device, and then select the SSID to join the network.

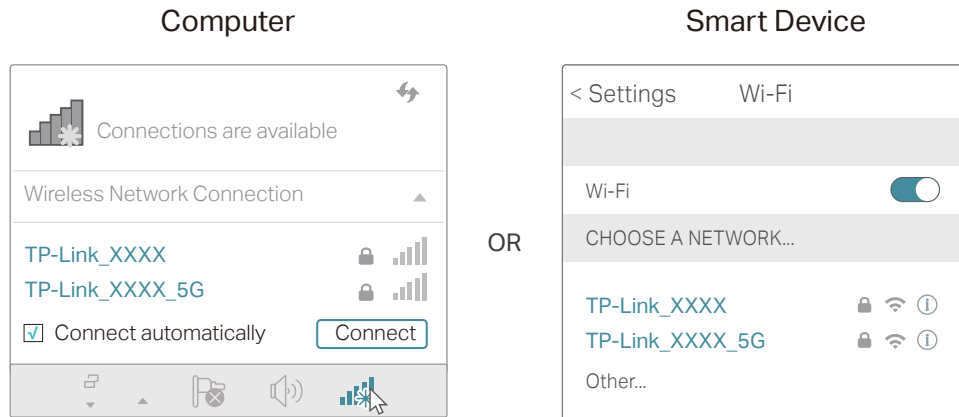

- **Method 3: Use the WPS button**

Wireless devices that support WPS, including Android phones, tablets and most USB network cards, can be connected to your router through this method ( not supported by iOS devices).

**Note:**

The WPS function cannot be configured if the wireless function of the router is disabled. Also, the WPS function will be disabled if your wireless encryption is WEP. Please make sure the wireless function is enabled and is configured with the appropriate encryption before configuring the WPS.

- 1) Tap the WPS icon on the device's screen. Here we take an Android phone as an example.
- 2) Immediately press the WPS button on your router.

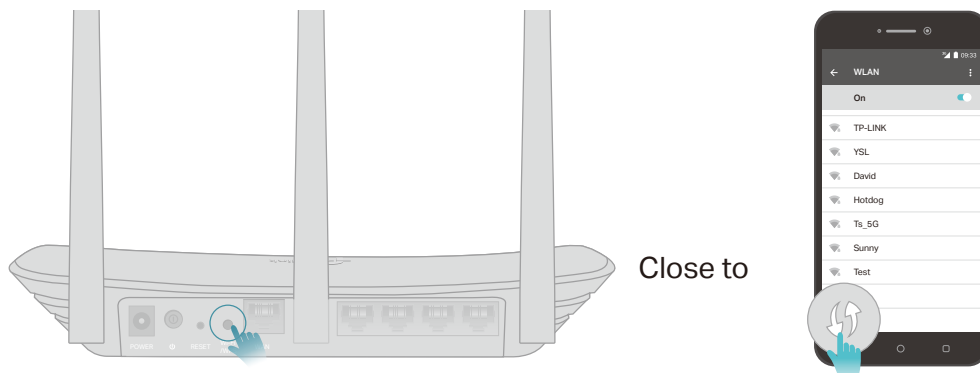

## Chapter 3

---

# Log In to the Router

---

This chapter introduces how to log in to the Web-based Utility of the router.

With the Web-based Utility, it is easy to configure and manage the router. The Web-based Utility can be used on any Windows, Macintosh or UNIX OS with a web browser, such as Microsoft the Internet Explorer, Mozilla Firefox or Apple Safari.

Follow the steps below to log in to your router.

1. Set up the TCP/IP Protocol in [Obtain an IP address automatically](#) mode on your computer.
2. Visit <http://tplinkwifi.net>, and log in with the password you set for the router. .

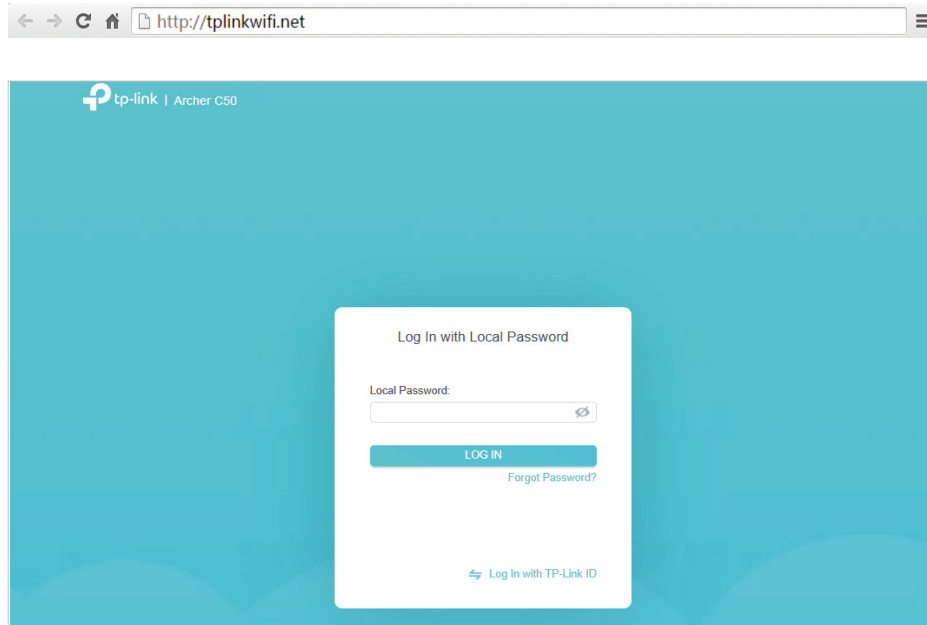

**Note:**

If the login window does not appear, please refer to the [FAQ](#) section.

## Chapter 4

---

# Configure the Router in Wireless Router Mode

---

This chapter presents how to configure the various features of the router working as a wireless router.

It contains the following sections:

- [Network Map](#)
- [Operation Mode](#)
- [Network Map](#)
- [TP-Link Cloud Service](#)
- [EasyMesh with Seamless Roaming](#)
- [Wireless Settings](#)
- [NAT Forwarding](#)
- [Parental Controls](#)
- [QoS](#)
- [Network Security](#)
- [IPv6](#)
- [Smart Life Assistant](#)
- [Manage the Router](#)

## 4.1. Network Map

Network Map outlines device connectivity of your network visually and helps you manage general settings of the network.

1. Visit <http://tplinkwifi.net>, and log in with your TP-Link ID or the password you set for the router.
2. Go to [Network Map](#).
3. Click each network device icon to check and manage general network settings.
  - Click [Internet](#) to check internet status.

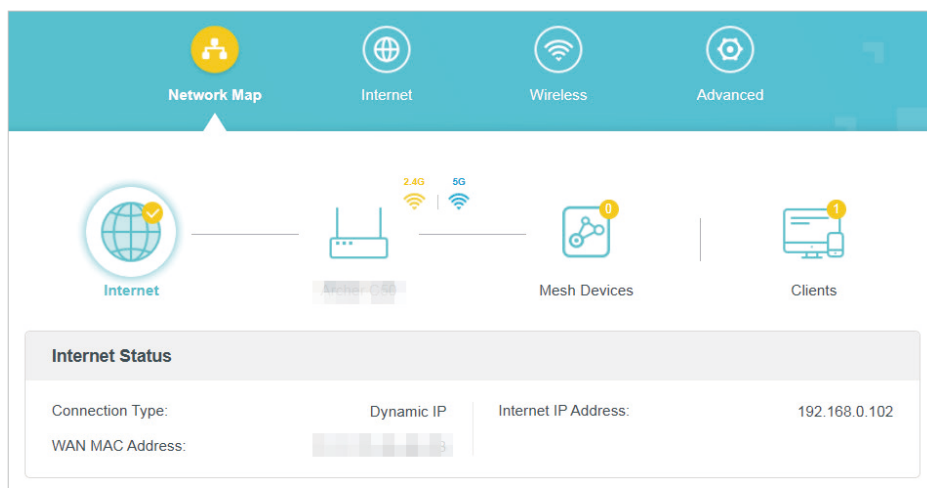

- Click the router to check device status and network settings. You can turn on or off the wireless network or guest network, or click [Edit](#) to change related settings.

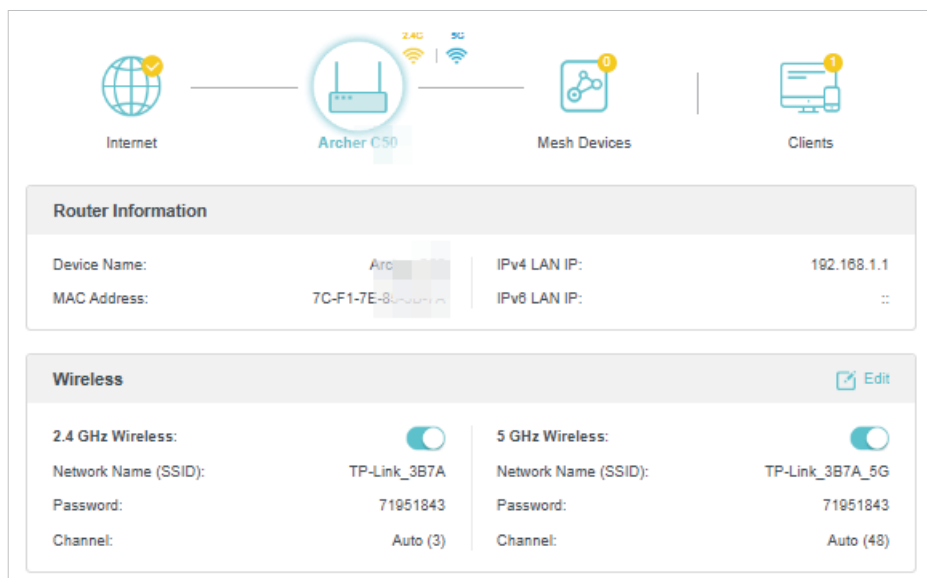

The screenshot displays three main sections of the router's configuration interface:

- Guest Network:** Features two wireless options. The 2.4 GHz Wireless is enabled with a network name (SSID) of TP-Link\_Guest\_3B7A. The 5 GHz Wireless is disabled with a network name (SSID) of TP-Link\_Guest\_3B7A\_5G.
- IoT Network:** Also features two wireless options. Both the 2.4 GHz and 5 GHz Wireless are enabled. The 2.4 GHz network name is TP-Link\_IoT\_3B7A with a password of 71951843. The 5 GHz network name is TP-Link\_IoT\_3B7A\_5G with the same password.
- Ethernet Status:** Shows the status of five ports: Internet (100Mbps Full Duplex), LAN 1 (—), LAN 2 (100Mbps Full Duplex), LAN 3 (—), and LAN 4 (—).

- Click [Mesh Devices](#) to view the devices that form a mesh network with the router.

The screenshot shows the network overview page with a navigation bar containing Internet, Archer, Mesh Devices, and Clients. The **Mesh Devices** section is active, displaying a table with the following data:

Device Info	IP Address	Location	Clients	Connection
EASYMESH DEVICE1 D8-44-89-E8-30-80	192.168.1.199	Living Room	0	

- Click [Clients](#) to view the client devices in your network. You can block devices so they cannot access your network, or set [Speed Limit](#) to limit their upload and download speeds.

The screenshot shows the network overview page with the **Clients** section active. It displays a table of connected clients with the following data:

Device Info	Real-time Rate	Tx/Rx Rate(Mbps)	Duration	Speed Limit	Operation
18101958-BG B0-19-21-AA-B2-58 192.168.1.220 (LAN)	↑ 46.4 Kbps ↓ 11.2 Kbps	---	9 Minutes	---	



**To limit the speeds of a device:**

1. Click  in the **Speed Limit** column.
2. Enable **Speed Limit**.
3. Set the download and upload speed limit according to your needs.

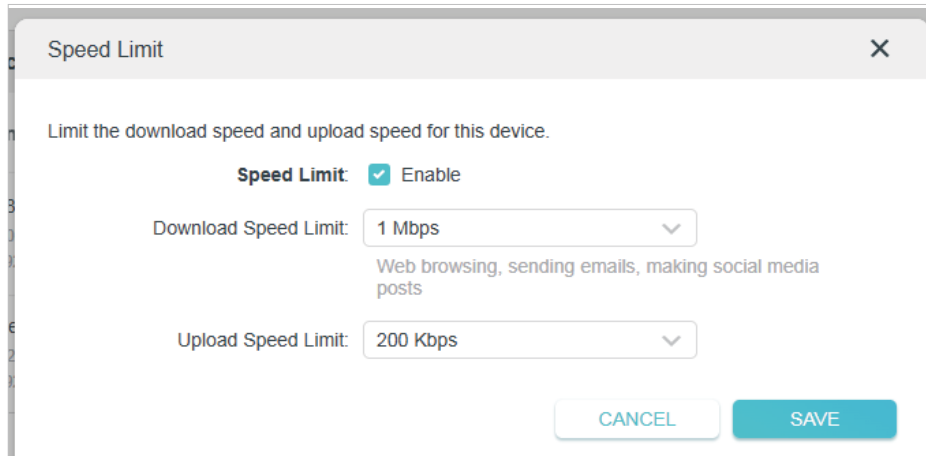

The image shows a 'Speed Limit' configuration dialog box. At the top, it says 'Limit the download speed and upload speed for this device.' Below this, there is a section for 'Speed Limit' with a checked checkbox labeled 'Enable'. Underneath, there are two dropdown menus: 'Download Speed Limit' set to '1 Mbps' and 'Upload Speed Limit' set to '200 Kbps'. A note below the download limit says 'Web browsing, sending emails, making social media posts'. At the bottom right, there are two buttons: 'CANCEL' and 'SAVE'.

4. Click **SAVE**. The speeds of the device will be limited.

## 4.2. Operation Mode

1. Visit <http://tplinkwifi.net>, and log in with the password you set for the router.
2. Go to **Advanced > Operation Mode**.
3. Select the working mode as needed and click **SAVE**.

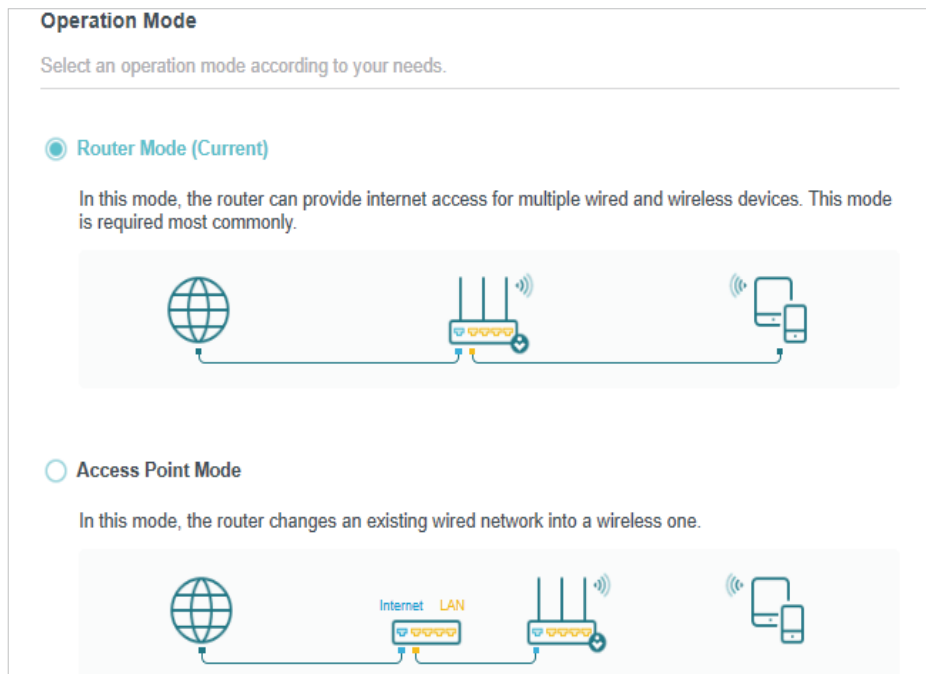

The image shows the 'Operation Mode' selection screen. It has a title 'Operation Mode' and a subtitle 'Select an operation mode according to your needs.' There are two radio button options: 'Router Mode (Current)' which is selected, and 'Access Point Mode'. Below each option is a diagram and a description. The 'Router Mode' diagram shows a globe connected to a router, which is connected to two wireless devices. The 'Access Point Mode' diagram shows a globe connected to a router's 'Internet' port, which is also connected to a 'LAN' port, and then to another router that is connected to two wireless devices.

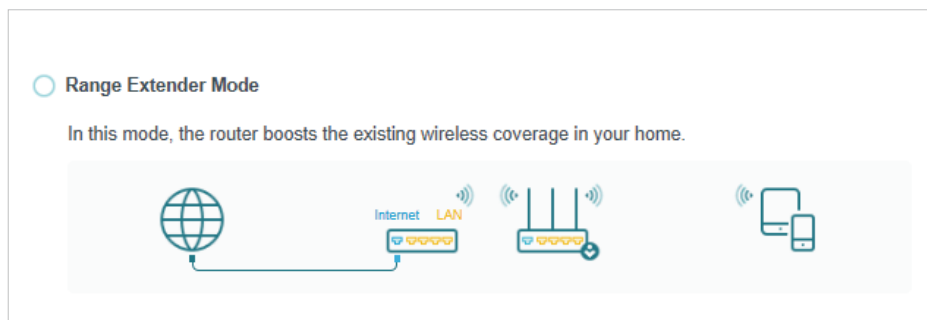

## 4.3. Network

This chapter guides you on how to configure advanced network features.

### 4.3.1. Status

You can view the current status information of the router.

1. Visit <http://tplinkwifi.net>, and log in with your TP-Link ID or the password you set for the router.
2. Go to **Advanced > Network > Status**.

**Status**

Internet status overview is displayed on this page.

**Internet**

Status: Connected

Internet Connection Type: Dynamic IP

IP Address: 192.168.0.103

Subnet Mask: 255.255.255.0

Default Gateway: 192.168.0.1

Primary DNS: 192.168.0.1

Secondary DNS: 0.0.0.0

**LAN**

MAC Address: D8-44-89-E8-30-80

IP Address: 192.168.1.1

Subnet Mask: 255.255.255.0

**DHCP Server**

DHCP Server: Enabled

IP Address Pool: 192.168.1.100-192.168.1.249

**Dynamic DNS**

Service Provider: NO-IP

Host Name:

Status: Disconnected

- **Internet** - This field displays the current settings of the WAN, and you can configure them on the [Advanced > Network > Internet](#) page.
  - **Status** - The current status of the WAN port. It indicates whether the WAN port is connected and whether it can access the internet.
  - **Internet Connection Type** - It indicates the current connection type of your router to establish internet connection.
  - **IP Address** - The current WAN (Internet) IP Address.
  - **Subnet Mask** - The subnet mask associated with the WAN IP Address.
  - **Default Gateway** - The Gateway currently used is shown here.
  - **DNS** - The IP addresses of the primary and secondary DNS (Domain Name System) server.
  - The IP Address, Subnet Mask, Default Gateway and DNS information will be blank or 0.0.0.0 if the IP Address is assigned dynamically and there is no internet connection.
- **LAN** - This field displays the current settings of the LAN, and you can configure them on the [Advanced > Network > LAN](#) page.
  - **MAC Address** - The physical address of the router.
  - **IP Address** - The LAN IP address of the router.
  - **Subnet Mask** - The subnet mask associated with the LAN IP address.
- **DHCP Server** - This field displays the current settings of the DHCP (Dynamic Host Configuration Protocol) server, and you can configure them on the [Advanced > Network > DHCP Server](#) page.
  - **DHCP Server** - It indicates whether the DHCP server is enabled or disabled. If disabled, you must have another DHCP server within your network or else you must configure the computer manually.
  - **IP Address Pool** - It specifies the range of IP addresses that the DHCP Server can assign to devices in the network.
- **Dynamic DNS** - This field displays the current settings of the DDNS (Dynamic Domain Name System) feature, and you can configure it on the [Advanced > Network > Dynamic DNS](#) page.
  - **Service Provider** - The DDNS Service Provider.
  - **Host Name** - The domain name for remote access to your device, website, or server behind the router you have created.
  - **Status** - It indicates whether the router is connected to the DDNS service provider.

### 4.3.2. Change the Internet Settings

After setting up your internet, you can also easily configure the internet settings if needed. You can change the MAC address, configure the DoH (DNS over HTTPS) feature, set up NAT and configure Internet Port Negotiation Speed Setting for the router.

1. Visit <http://tplinkwifi.net>, and log in with your TP-Link ID or the password you set for the router.

2. Go to [Advanced](#) > [Network](#) > [Internet](#).

- **To configure the internet connection settings:**

1. Select Internet Connection Type and configure the settings according to the information provided by your ISP.
2. Click Advanced settings to reveal the advanced settings and change them if needed. It's recommended to keep the default settings.
3. Click SAVE.

- **To change the MAC address:**

You can set the MAC address of your router. Use the default address unless your ISP allows internet access from only a specific MAC address. You have three options:

- [Use Default MAC Address](#) - Do not change the default MAC address of your router in case the ISP does not bind the assigned IP address to the MAC address.
  - [Clone Current Device MAC](#) - Select to copy the current MAC address of the computer that is connected to the router, in case the ISP binds the assigned IP address to the MAC address.
  - [Use Custom MAC Address](#) - Select if your ISP requires you to register the MAC address and enter the correct MAC address in this field, in case the ISP binds the assigned IP address to the specific MAC address.
- **To configure the DoH (DNS over HTTPS) feature:**

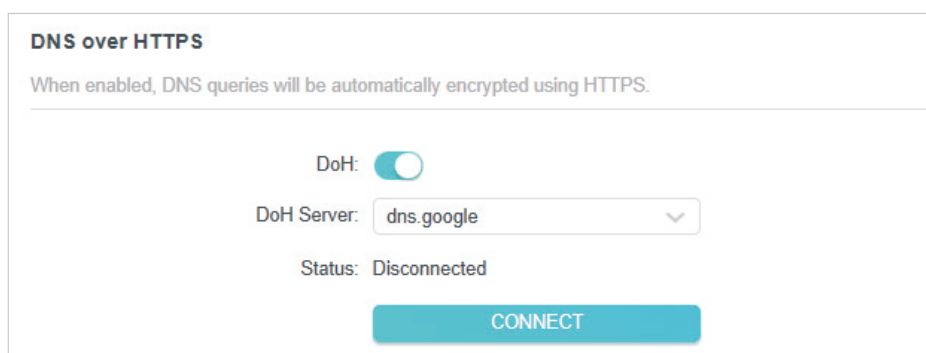

**DNS over HTTPS**

When enabled, DNS queries will be automatically encrypted using HTTPS.

DoH:

DoH Server:

Status: Disconnected

[CONNECT](#)

1. Click to enable DoH (DNS over HTTPS). When enabled, DNS queries will be automatically encrypted using HTTPS.
2. Select a DoH Server from the dropdown list.
3. Click [CONNECT](#).

- **To set up NAT:**

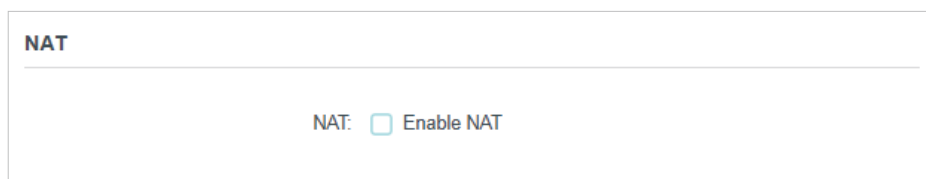

**NAT**

NAT:  Enable NAT

The router's NAT (Network Address Translation) feature makes devices on the LAN use the same public IP address to communicate with devices on the internet, which protects the local network by hiding IP addresses of the devices.

If you want to enable or disable NAT, tick or untick the [Enable NAT](#) checkbox, and click [SAVE](#).

- **To configure Internet Port Negotiation Speed Setting:**

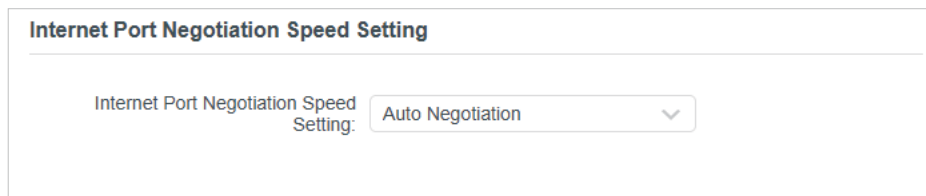

Internet Port Negotiation Speed Setting

Internet Port Negotiation Speed Setting: Auto Negotiation

You can change the internet port speed mode. Auto Negotiation is recommended.

### 4.3.3. Change the LAN Settings

The router is preset with a default LAN IP, which you can use to log in to its web management page. The LAN IP address together with the Subnet Mask also defines the subnet that the connected devices are on. If the IP address conflicts with another device on your local network or your network requires a specific IP subnet, you can change it.

1. Visit <http://tplinkwifi.net>, and log in with your TP-Link ID or the password you set for the router.
2. Go to [Advanced](#) > [Network](#) > [LAN](#).
3. Type in a [new IP Address](#) appropriate to your needs. And leave the Subnet Mask as the default settings.
4. Click [SAVE](#).

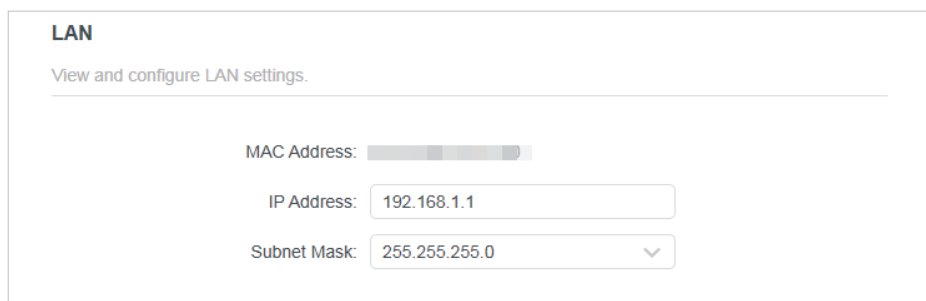

LAN

View and configure LAN settings.

MAC Address:

IP Address:

Subnet Mask:

**Note:** If you have set the Port Forwarding, DMZ or DHCP address reservation, and the new LAN IP address is not in the same subnet with the old one, then you should reconfigure these features.

### 4.3.4. Configure to Support IPTV Service

You can configure IPTV/VLAN settings if you want to enjoy IPTV or VoIP service, or if your ISP requires VLAN tags.

1. Visit <http://tplinkwifi.net>, and log in with your TP-Link ID or the password you set for the router.
2. Go to [Advanced](#) > [Network](#) > [IPTV/VLAN](#).

3. If your ISP provides the networking service based on IGMP technology, e.g., British Telecom(BT) and Talk Talk in UK:

- 1) Tick the **IGMP Proxy** and **IGMP Snooping** checkbox, then select the **IGMP Version**, either V2 or V3, as required by your ISP.

**Multicast**

Check the multicast setting. It is recommended to keep them as default.

IGMP Snooping:  Enable

IGMP Proxy:  Enable

IGMP Version: V2

- 2) Click **SAVE**.
- 3) After configuring IGMP proxy, IPTV can work behind your router now. You can connect your set-top box to any of the router's Ethernet port.

**If IGMP is not the technology your ISP applies to provide IPTV service:**

- 1) Tick **Enable IPTV/VLAN**.
- 2) Select the appropriate **Mode** according to your ISP.
  - Select **Bridge** if your ISP is not listed and no other parameters are required.
  - Select **Custom** if your ISP is not listed but provides necessary parameters.

**IPTV/VLAN**

Configure IPTV/VLAN settings if you want to enjoy IPTV or VoIP service, or if your ISP requires VLAN tags.

IPTV/VLAN:  Enabled

Mode: Bridge

LAN 1:

LAN 2:

LAN 3:

LAN 4:

Vietnam-Viettel

Portugal-Meo

Portugal-Vodafone

Australia-NBN

New Zealand-UFB

Bridge

Custom

- 3) After you have selected a mode, the necessary parameters, including the LAN port for IPTV connection, are predetermined. If not, select the LAN type to determine which port is used to support IPTV service.

**IPTV/VLAN**

Configure IPTV/VLAN settings if you want to enjoy IPTV or VoIP service, or if your ISP requires VLAN tags.

IPTV/VLAN:  Enable

Mode:

LAN1:

LAN2:

LAN3:

LAN4:

Tip: The LAN port cannot be used for EasyMesh Ethernet backhaul when it is set for IPTV or VoIP service.

- 4) Click [SAVE](#).
- 5) Connect the set-top box to the corresponding LAN port which is predetermined or you have specified in Step 3.

## Done!

Your IPTV setup is done now! You may need to configure your set-top box before enjoying your TV.

### 4.3.5. Specify DHCP Server Settings

By default, the DHCP (Dynamic Host Configuration Protocol) Server is enabled and the router acts as a DHCP server; it dynamically assigns TCP/IP parameters to client devices from the IP Address Pool. You can change the settings of the DHCP Server if necessary, and you can reserve LAN IP addresses for specified client devices.

1. Visit <http://tplinkwifi.net>, and log in with your TP-Link ID or the password you set for the router.
2. Go to [Advanced](#) > [Network](#) > [DHCP Server](#).

- **To specify the IP address that the router assigns:**

**DHCP Server**

Dynamically assign IP addresses to the devices connected to the router.

DHCP Server:  Enable

IP Address Pool:  -

Address Lease Time:  minutes

Default Gateway:  (Optional)

Primary DNS:  (Optional)

Secondary DNS:  (Optional)

1. Tick the [Enable](#) checkbox.
2. Enter the starting and ending IP addresses in the [IP Address Pool](#).

3. Enter the [Address Lease Time](#). It is the amount of time a network user will be allowed to connect to the router with the current dynamic IP Address. When time is up, the user will be automatically assigned a new dynamic IP address. The range of the time is 1 ~ 2880 minutes. The default value is 120.
4. Set the [Default Gateway \(Optional\)](#). It is suggested to input the IP address of the LAN port of the router.
5. Set the [DNS Server \(Optional\)](#). Input the DNS IP address provided by your ISP.
6. Set the [Secondary DNS Server \(Optional\)](#). Input the IP address of another DNS server if your ISP provides two DNS servers.
7. Click [SAVE](#).

- **To reserve an IP address for a specified client device:**

1. Click [Add](#) in the [Address Reservation](#) section.

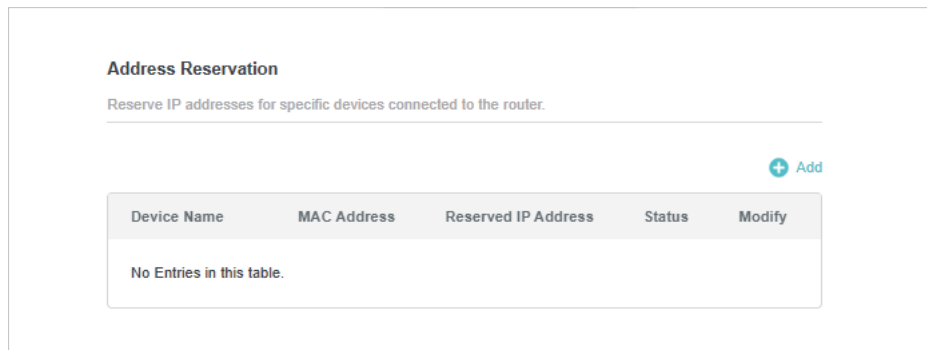

2. Click [VIEW CONNECTED DEVICES](#) and select the you device you want to reserve an IP for. Then the [MAC Address](#) will be automatically filled in. Or enter the [MAC address](#) of the client device manually.

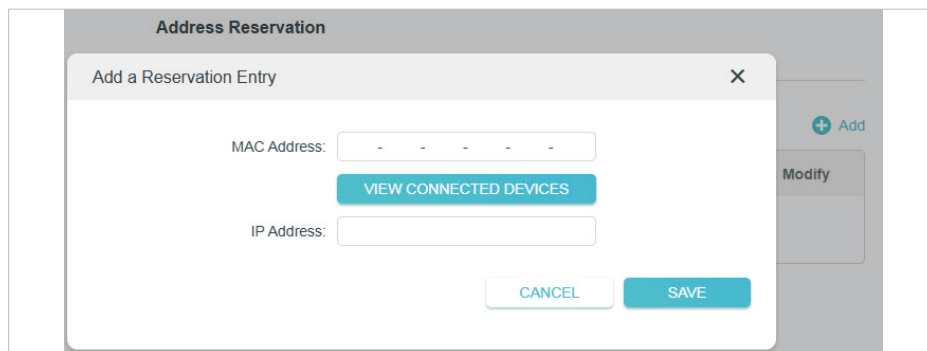

3. Enter the [IP address](#) to reserve for the client device.
4. Click [SAVE](#).

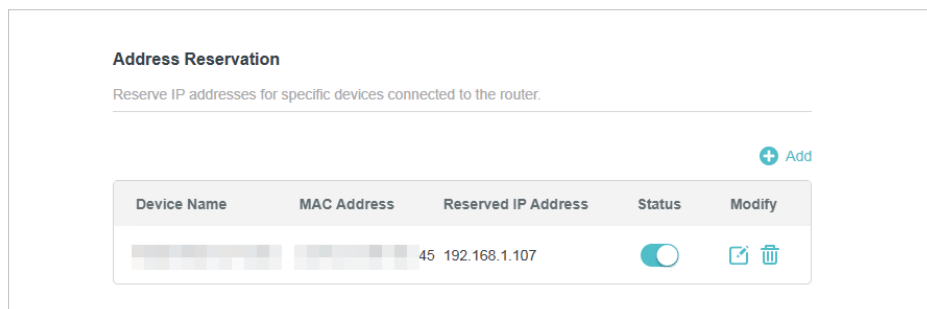

- To view devices assigned with IP addresses by the DHCP server:

You can view the devices that are currently assigned with IP addresses by the DHCP server in [DHCP Client List](#).

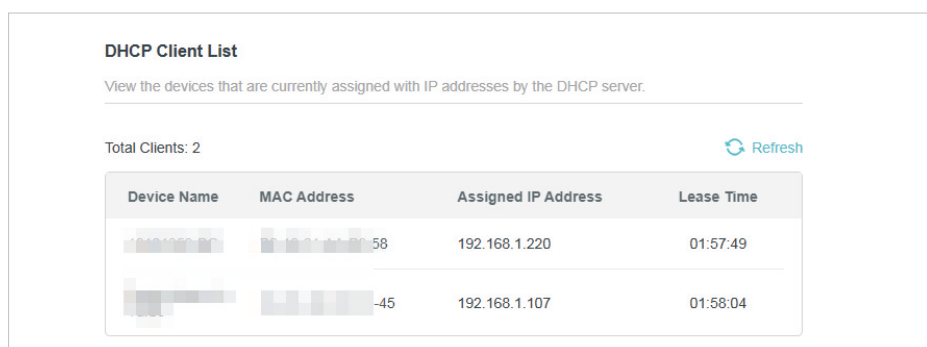

### 4.3.6. Set Up a Dynamic DNS Service Account

Most ISPs assign a dynamic IP address to the router and you can use this IP address to access your router remotely. However, the IP address can change from time to time and you don't know when it changes. In this case, you might apply the DDNS (Dynamic Domain Name Server) feature on the router to allow you and your friends to access your router and local servers (FTP, HTTP, etc.) using a domain name without checking and remembering the IP address.

Note: DDNS does not work if the ISP assigns a private WAN IP address (such as 192.168.1.x) to the router.

1. Visit <http://tplinkwifi.net>, and log in with your TP-Link ID or the password you set for the router.
2. Go to [Advanced](#) > [Network](#) > [Dynamic DNS](#).
3. Select the DDNS [Service Provider](#): TP-Link, NO-IP or DynDNS. It is recommended to select TP-Link so that you can enjoy TP-Link's superior DDNS service. Otherwise, please select NO-IP or DynDNS. If you don't have a DDNS account, you have to register first by clicking [Register Now](#).

### Dynamic DNS

Assign a fixed host name (domain name) for remote access to your device, website, or server behind the router.

---

Service Provider: TP-Link ▼

**Note:** To use TP-Link DDNS service, [log in](#) with your TP-Link ID.

 **Note:** To enjoy TP-Link's DDNS service, you have to log in with a TP-Link ID. If you have not logged in with one, click [log in](#).

- Click [Register](#) in the [Domain Name List](#) if you have selected TP-Link, and enter the [Domain Name](#) as needed.

### Dynamic DNS

Assign a fixed host name (domain name) for remote access to your device, website, or server behind the router.

---

Service Provider: TP-Link ▼

Current Domain Name:

#### Domain Name List

[+ Register](#)

Domain Name	Registered Date	Status	Operation	Delete
No Entries				

If you have selected NO-IP or DynDNS, enter the username, password and domain name of your account. Click [LOGIN AND SAVE](#).

### Dynamic DNS

Assign a fixed host name (domain name) for remote access to your device, website, or server behind the router.

---

Service Provider: NO-IP ▼ [Register Now](#)

Username:

Password:  

Domain Name:

WAN IP binding:  Enable

Status: Disconnected

LOGIN AND SAVE  
LOGOUT

 **Tips:** If you want to use a new DDNS account, please click [Logout](#) first, and then log in with a new account.

### 4.3.7. Static Routing

Static routing is a form of routing that is configured manually by a network administrator or a user by adding entries into a routing table. The manually-configured routing information guides the router in forwarding data packets to the specific destination.

- **To create static routes:**

**I want to:**

Visit multiple networks and servers at the same time.

**For example,** in a small office, my PC can surf the internet through Router A, but I also want to visit my company's network. Now I have a switch and Router B. I connect the devices as shown in the following figure so that the physical connection between my PC and my company's server is established. To surf the internet and visit my company's network at the same time, I need to configure the static routing.

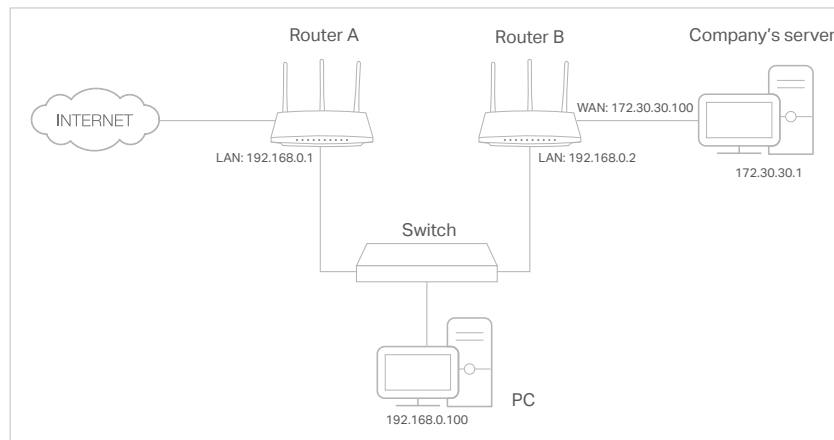

**How can I do that?**

1. Change the routers' LAN IP addresses to two different IP addresses on the same subnet. Disable Router B's DHCP function.
2. Visit <http://tplinkwifi.net>, and log in with your TP-Link ID or the password you set for Router A.
3. Go to **Advanced > Network > Routing**.
4. Click **Add** and finish the settings according to the following explanations:

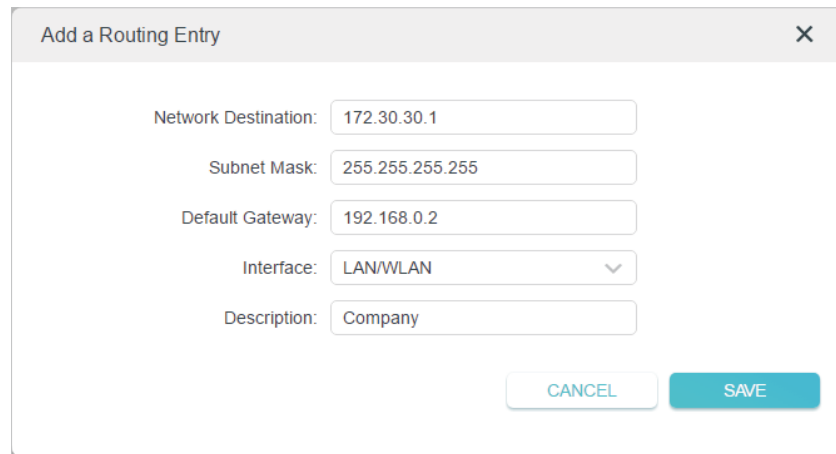

The screenshot shows a dialog box titled "Add a Routing Entry" with a close button (X) in the top right corner. The dialog contains the following fields and values:

- Network Destination: 172.30.30.1
- Subnet Mask: 255.255.255.255
- Default Gateway: 192.168.0.2
- Interface: LAN/WLAN (dropdown menu)
- Description: Company

At the bottom right of the dialog, there are two buttons: "CANCEL" and "SAVE".

**Network Destination:** The destination IP address that you want to assign to a static route. This IP address cannot be on the same subnet with the WAN IP or LAN IP of Router A. In the example, the IP address of the company network is the destination IP address, so here enter 172.30.30.1.

**Subnet Mask:** Determines the destination network with the destination IP address. If the destination is a single IP address, enter 255.255.255.255; otherwise, enter the subnet mask of the corresponding network IP. In the example, the destination network is a single IP, so here enter 255.255.255.255.

**Default Gateway:** The IP address of the gateway device to which the data packets will be sent. This IP address must be on the same subnet with the router's IP which sends out data. In the example, the data packets will be sent to the LAN port of Router B and then to the Server, so the default gateway should be 192.168.0.2.

**Interface:** Determined by the port (WAN/LAN) that sends out data packets. In the example, the data are sent to the gateway through the LAN port of Router A, so **LAN/WLAN** should be selected.

**Description:** Enter a description for this static routing entry.

5. Click **SAVE**.
6. Check the **Routing Table** below. If you can find the entry you've set, the static routing is set successfully.

Add a Routing Entry
✕

Network Destination:

Subnet Mask:

Default Gateway:

Interface:  ▾

Description:

Done! Open a web browser on your PC. Enter the company server's IP address to visit the company network.

- **To view the Routing Table:**

1. Visit <http://tplinkwifi.net>, and log in with your TP-Link ID or the password you set for Router A.
2. Go to [Advanced](#) > [Network](#) > [Routing](#). You can view all valid routing entries that are currently in use in the [Routing Table](#).

**Routing Table**

View all valid routing entries that are currently in use.

---

Active Route Number: 4  Refresh

Network Destination	Subnet Mask	Gateway	Interface
0.0.0.0	0.0.0.0	192.168.0.1	WAN
192.168.0.0	255.255.255.0	192.168.0.101	WAN
192.168.1.0	255.255.255.0	192.168.1.1	LAN/WLAN
192.168.0.2	255.255.255.255	192.168.0.1	WAN

## 4.4. TP-Link Cloud Service

TP-Link Cloud service provides a better way to manage your cloud devices. Log in to your router with a TP-Link ID, and you can easily monitor and manage your home network when you are out and about via the Tether app. To ensure that your router stays new and gets better over time, the TP-Link Cloud will notify you when an important firmware upgrade is available. Surely you can also manage multiple TP-Link Cloud devices with a single TP-Link ID.

### 4.4.1. Register a TP-Link ID

If you have skipped the registration during the Quick Setup process, you can:

1. Visit <http://tplinkwifi.net>, and log in with the password you set for the router.
2. Go to [Advanced](#) > [TP-Link ID](#) or click [TP-Link ID](#) on the very top of the page.
3. Click [Sign Up](#) and follow the instructions to register a TP-Link ID.

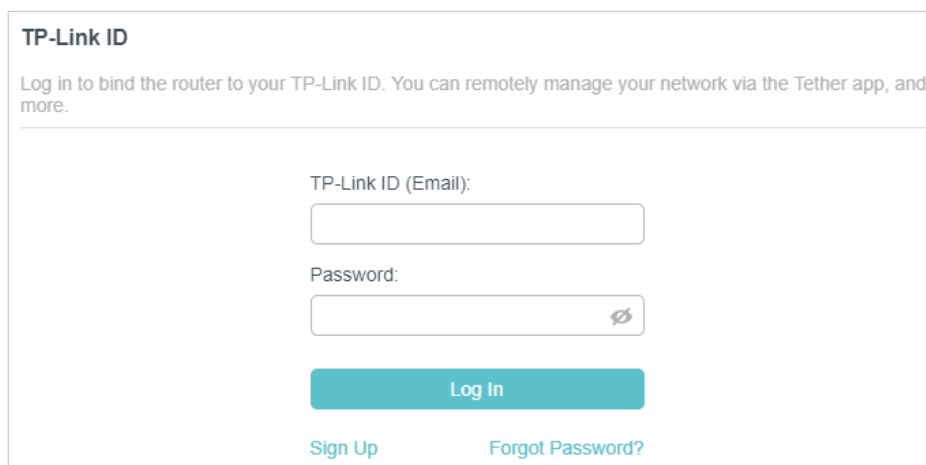

**TP-Link ID**

Log in to bind the router to your TP-Link ID. You can remotely manage your network via the Tether app, and more.

TP-Link ID (Email):

Password:

[Log In](#)

[Sign Up](#) [Forgot Password?](#)

4. After activating your TP-Link ID, come back to the TP-Link ID page to log in. The TP-Link ID used to log in to the router for the first time will be automatically bound as an [Admin](#).

**Note:**

- To learn more about the [Admin](#) and [User](#) TP-Link ID, refer to [Manage the User TP-Link IDs](#).
- Once you have registered a TP-Link ID on the web management page, you can only register another TP-Link ID via the Tether APP. Please refer to [Manage the Router via the TP-Link Tether App](#) to install the app.
- If you want to unbind the admin TP-Link ID from your router, please go to [Advanced](#) > [TP-Link ID](#), and click [Unbind](#) in the [Device Information](#) section.

### 4.4.2. Change Your TP-Link ID Information

Follow the steps below to change your email address and password of your TP-Link ID as needed.

1. Visit <http://tplinkwifi.net>, and log in with your TP-Link ID.

2. Go to [Advanced](#) > [TP-Link ID](#), and focus on the [Account Information](#) section.

- **To change your email address:**

1. Click  behind the Email.
2. Enter the password of your TP-Link ID, then a new email address. And click [SAVE](#).

### Change Email ✕

**Note:** New email or password may not sync to client devices immediately. Please log in again when your device is connected to the Internet to update account information.

- **To change your password:**

1. Click  behind the Password.
2. Enter the current password, then a new password twice. And click [SAVE](#).

### Change Password ✕

Low	Middle	High
-----	--------	------

**Note:** New email or password may not sync to client devices immediately. Please log in again when your device is connected to the Internet to update account information.

### 4.4.3. Manage the User TP-Link IDs

The TP-Link ID used to log in to the router for the first time will be automatically bound as the **Admin** account. An admin account can add or remove other TP-Link IDs to or from the same router as **Users**. All accounts can monitor and manage the router locally or remotely, but user accounts cannot:

- Reset the router to its factory default settings either on the web management page or in the Tether app.
- Add/remove other TP-Link IDs to/from the router.

- **Add TP-Link ID to Manage the Router**

1. Visit <http://tplinkwifi.net>, and log in with your TP-Link ID.
2. Go to **Advanced > TP-Link ID**, and focus on the **Bound Accounts** section.
3. Click **+ Bind**, enter another TP-Link ID as needed and click **SAVE**.

**Note:** If you need another TP-Link ID, please register a new one via the Tether app. Refer to [Manage the Router via the TP-Link Tether App](#) to install the app and register a new TP-Link ID.

4. The new TP-Link ID will be displayed in the Bound Accounts table as a **User**.

Bound Accounts				
<span style="color: teal;">+</span> Bind <span style="color: red;">-</span> Unbind				
<input type="checkbox"/>	ID	Email	Binding Date	Role
<input type="checkbox"/>	1	admin_123@tplink.com	2023-10-27	Admin
<input type="checkbox"/>	2	admin12345@tplink.com	2023-10-27	User

- **Remove TP-Link ID(s) from Managing the Router**

1. Visit <http://tplinkwifi.net>, and log in with your TP-Link ID.
2. Go to **Advanced > TP-Link ID**, and focus on the **Bound Accounts** section.
3. Tick the checkbox(es) of the TP-Link ID(s) you want to remove and click **Unbind**.

Bound Accounts				
<span style="color: green;">+</span> Bind <span style="color: red;">-</span> Unbind				
<input type="checkbox"/>	ID	Email	Binding Date	Role
<input type="checkbox"/>	1	admin_123@tp-link.com	2023-10-27	Admin
<input checked="" type="checkbox"/>	2	admin_123@tp-link.com	2023-10-27	User

#### 4.4.4. Manage the Router via the TP-Link Tether App

The Tether app runs on iOS and Android devices, such as smartphones and tablets.

1. Launch the Apple App Store or Google Play store and search “TP-Link Tether” or simply scan the QR code to download and install the app.



2. Launch the Tether app and log in with your TP-Link ID.

Note: If you don't have a TP-Link ID, create one first.

3. Connect your device to the router's wireless network.
4. Go back to the Tether app, select the model of your router and log in with the password you set for the router.
5. Manage your router as needed.

Note: If you need to remotely access your router from your smart devices, you need to:

- Log in with your TP-Link ID. If you don't have one, refer to [Register a TP-Link ID](#).
- Make sure your smartphone or tablet can access the internet with cellular data or a Wi-Fi network.

### 4.5. EasyMesh with Seamless Roaming

EasyMesh routers and extenders work together to form one unified Wi-Fi network. Walk through your home and stay connected with the fastest possible speeds thanks to EasyMesh's seamless coverage.

Note: Routers and range extenders must be compatible with EasyMesh or OneMesh™. Firmware upgrades may be required.

- **Add a Router as a Satellite Device:**

1. Visit <http://tplinkwifi.net>, and log in with your TP-Link ID or the password you set for the router.
2. Go to **Advanced > EasyMesh**, and enable **EasyMesh**.

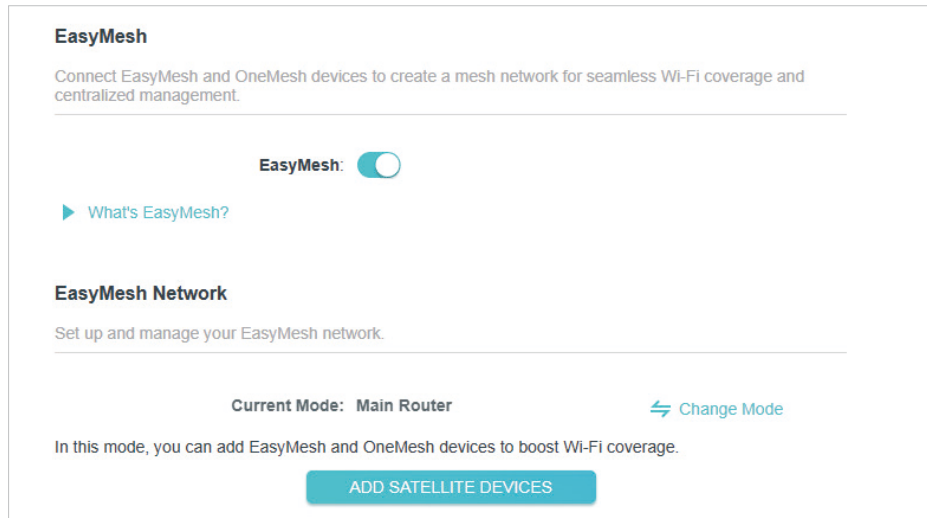

3. Click [ADD SATELLITE DEVICES](#), select [TP-Link Router](#), then click [NEXT](#).

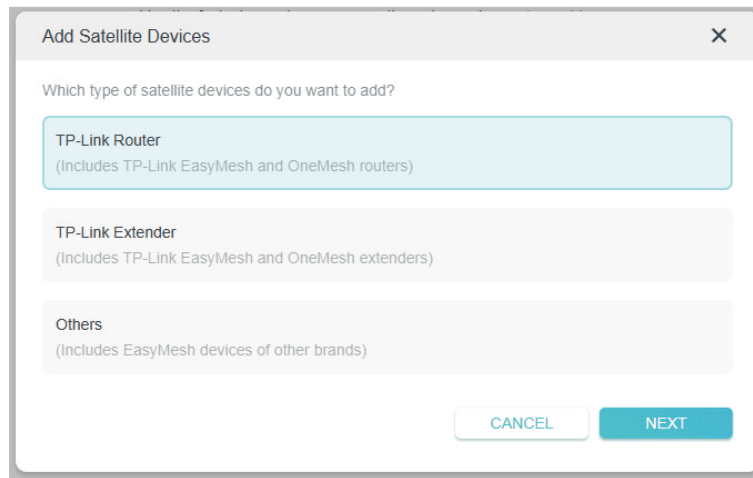

4. Follow the page instructions to prepare your satellite device, then click [DONE](#).

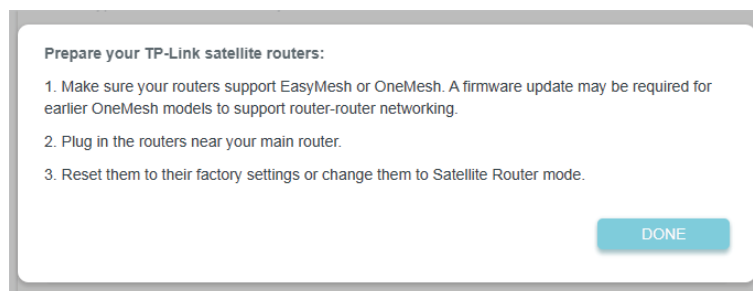

5. Click [ADD](#). When prompted "This device has been added successfully", click [OK](#), then click [FINISH](#).

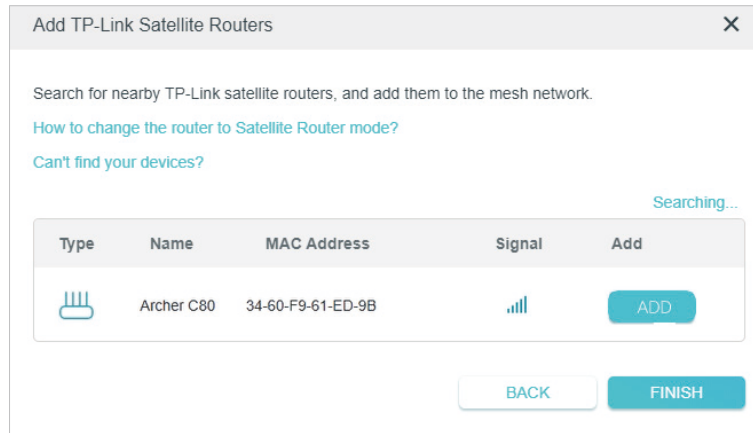

- **Add a Range Extender as a Satellite Device:**

1. Visit <http://tplinkwifi.net>, and log in with your TP-Link ID or the password you set for the router.
2. Go to **Advanced > EasyMesh**, and enable **EasyMesh**.

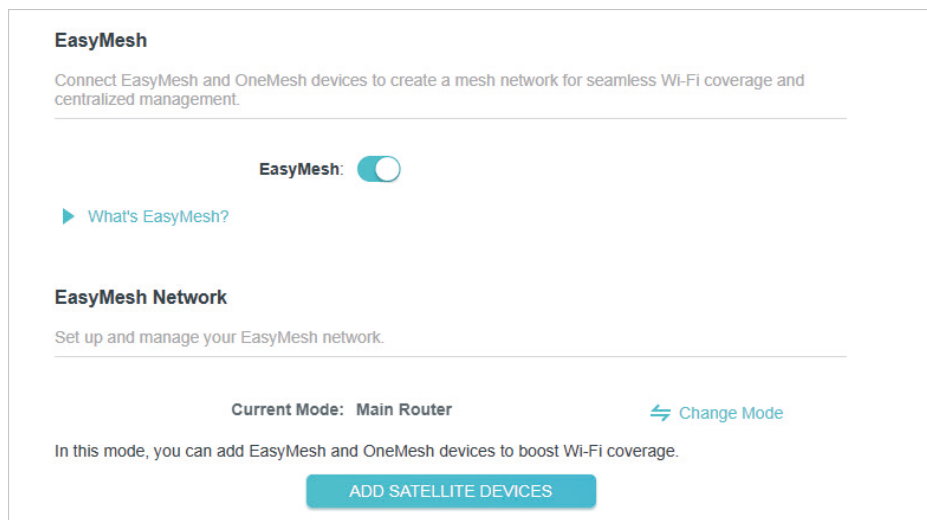

3. Plug in the extender next to the main router.
4. Within 2 minutes, press the WPS button on main router and on the extender. Wait until the WPS process is complete.
5. Done! You can check the mesh device on the router's web page too.

### EasyMesh

Connect EasyMesh and OneMesh devices to create a mesh network for seamless Wi-Fi coverage and centralized management.

---

**EasyMesh:**

Tip: Enable [Smart Connect](#) to work with EasyMesh for better seamless roaming.

[▶ What's EasyMesh?](#)

---

### EasyMesh Network

Set up and manage your EasyMesh network.





---

**Current Mode:** **Main Router** [↔ Change Mode](#)

In this mode, you can add EasyMesh and OneMesh devices to boost Wi-Fi coverage.

**Note:** TP-Link satellite routers will follow the main router's [LED Control](#) Settings.

Satellite Devices: 1



Device Info	IP Address	Location	Clients	Connection	Modify
 AM_E5 00-AA-EB-07-20-66	192.168.0.22	Not set	0		 

[ADD SATELLITE DEVICES](#)

- **Manage Devices in the EasyMesh Network:**

In an EasyMesh network, you can manage all mesh devices and connected clients on your main router's web page.

- **View EasyMesh Devices and Connected Clients in the Network:**

1. Visit <http://tplinkwifi.net>, and log in with your TP-Link ID or the password you set for the router.
2. Go to [Network Map](#).
3. Click  to view all mesh devices, and click  to view all connected clients.

- **Manage an EasyMesh device in the network:**

1. Visit <http://tplinkwifi.net>, and log in with your TP-Link ID or the password you set for the router.
2. Go to [Advanced](#) > [EasyMesh](#).
3. Click the Modify button to view detailed information and change its settings.

- **Name** - Enter a name for the EasyMesh Device.
- **Location** - Select a location for the EasyMesh Device from the dropdown list.
- **Clients** - View the connected client devices.
- Click **Manage** to redirect to the web management page of this device.
- Click **Remove** to delete this device from the EasyMesh network.

4. Click **SAVE**.

## 4.6. Wireless Settings

This chapter guides you on how to configure the wireless settings.

### 4.6.1. Specify Wireless Settings

You can personalize wireless settings as you need.

1. Visit <http://tplinkwifi.net>, and log in with your TP-Link ID or the password you set for the router.
2. Go to **Wireless** or **Advanced > Wireless > Wireless Settings**.

- **To use the Smart Connect function:**

When enabled, the 2.4 GHz and 5 GHz networks share the same network name and password (only one SSID will be displayed), and your wireless device will automatically switch connection to the Wi-Fi band that provides the fastest speed.

1. Go to [Wireless](#) or [Advanced](#) > [Wireless](#) > [Wireless Settings](#).
2. Enable [Smart Connect](#).
3. Keep the default values or set a new SSID and password, and click [SAVE](#). This SSID and password will be applied for the 2.4 GHz and 5 GHz wireless networks. If you want to configure the wireless settings separately for each band, deselect the checkbox to disable this feature.

- **To enable or disable the wireless function:**

1. Go to [Wireless](#) or [Advanced](#) > [Wireless](#) > [Wireless Settings](#).
2. The wireless bands are enabled by default. If you want to disable a wireless band, just deselect its [Enable](#) checkbox.

- **To change the wireless network name (SSID) and wireless password:**

1. Go to [Wireless](#) or [Advanced > Wireless > Wireless Settings](#).
2. Create a new SSID in [Network Name \(SSID\)](#) and customize the password for the network in [Password](#). The value is case-sensitive.

 **Note:** If you change the wireless settings with a wireless device, you will be disconnected when the settings are effective. Please write down the new SSID and password for future use.

- **To hide SSID:**

1. Go to [Wireless](#) or [Advanced > Wireless > Wireless Settings](#).
2. Select [Hide SSID](#), and your SSID won't display when you scan for local wireless networks on your wireless device and you need to manually join the network.

- **To change the security option:**

1. Go to [Wireless](#) or [Advanced > Wireless > Wireless Settings](#).
2. Select an option from the [Security](#) drop-down list. We recommend you don't change the default settings unless necessary.

- **To change the transmit power:**

1. Go to [Advanced > Wireless > Wireless Settings](#).
2. Select an option from the [Transmit Power](#) drop-down list: [High](#), [Middle](#) or [Low](#). The default and recommended setting is [High](#).

- **To change channel settings:**

1. Go to [Advanced > Wireless > Wireless Settings](#).
2. Select a [Channel Width](#) (bandwidth) for the wireless network. It is recommended to just leave it as default.
3. Select an operating [Channel](#) for the wireless network. It is recommended to leave the channel to [Auto](#) if you are not experiencing the intermittent wireless connection issue.

- **To change the transmission mode:**

1. Go to [Advanced > Wireless > Wireless Settings](#).
2. Disable [Smart Connect](#), then select a transmission [Mode](#) according to your wireless client devices. It is recommended to just leave it as default.

- **To Share Network:**

1. Go to [Wireless](#) or [Advanced > Wireless > Wireless Settings](#).
2. Click [Share Network](#) to share the SSID and password to your guests.



### 4.6.2. Guest Network

Guest Network allows you to provide Wi-Fi access for guests without disclosing your host network. When you have guests in your house, apartment, or workplace, you can create a guest network for them. In addition, you can customize guest network settings to ensure network security and privacy.

- **Create a Network for Guests:**

1. Visit <http://tplinkwifi.net>, and log in with your TP-Link ID or the password you set for the router.
2. Go to **Advanced > Wireless > Guest Network** or go to **Wireless** and locate the **Guest Network** section.
3. Create a guest network as needed.
  - 1) Tick the Enable checkbox for the 2.4GHz or 5 GHz wireless network.
  - 2) Customize the SSID. Don't select **Hide SSID** unless you want your guests to manually input the SSID for guest network access.
  - 3) Click **Share Network** to share the SSID and password to your guests.
  - 4) Enable **Bandwidth Control** if you want to limit the network speed of your guests. Then enter the limited bandwidth value.
  - 5) Set the **Effective Time** to keep the guest network on during the selected duration.
  - 6) Select the **Security** type and customize your own password. If **None** is selected, no password is needed to access your guest network.

**Guest Network**

Create a separate network for your guests to ensure network security and privacy.

---

2.4 GHz:  Enable [Share Network](#)

Network Name (SSID):   Hide SSID

Bandwidth Control:  Enable

5 GHz:  Enable [Share Network](#)

Network Name (SSID):   Hide SSID

Bandwidth Control:  Enable

Download Bandwidth:  Mbps

Upload Bandwidth:  Mbps

Security:  ▼

This security type is not considered secure.  
Consider selecting the WPA2-PSK[AES] or WPA3 encryption.

Effective Time:  ▼

4. Click [SAVE](#). Now your guests can access your guest network using the SSID and password you set!

 **Tips:** To view guest network information, go to [Network Map](#) and locate the [Guest Network](#) section. You can turn on or off the guest network function conveniently.

- **Customize Guest Network Options:**

1. Visit <http://tplinkwifi.net>, and log in with your TP-Link ID or the password you set for the router.
2. Go to [Advanced](#) > [Wireless](#) > [Guest Network](#). Locate the [Guest Permissions](#) section.
3. Customize guest network options according to your needs.

**Guest Permissions**

Control the data that guests can access.

---

Allow guests to see each other

Allow guests to access your local network

- [Allow guests to see each other](#)

Tick this checkbox if you want to allow the wireless clients on your guest network to communicate with each other via methods such as network neighbors and Ping.

- [Allow guests to access your local network](#)

Tick this checkbox if you want to allow the wireless clients on your guest network to communicate with the devices connected to your router's LAN ports or main network via methods such as network neighbors and Ping.

4. Click **SAVE**. Now you can ensure network security and privacy!

### 4.6.3. IoT Network

This feature further secures your home network by allowing you to create a dedicated wireless network to manage your IoT devices together, such as smart lights and cameras.

1. Visit <http://tplinkwifi.net>, and log in with your TP-Link ID or the password you set for the router.
2. Go to **Advanced > Wireless > IoT Network** or go to **Wireless** and locate the **IoT Network** section.
3. Create an IoT network as needed.
  - 1) Tick the Enable checkbox for the 2.4GHz or 5 GHz wireless network. For 5 GHz IoT networks, make sure your IoT devices can connect to a 5 GHz network.
  - 2) Customize the SSID. Don't select **Hide SSID** unless you want your IoT devices to manually input the SSID for network access.
  - 3) Click **Share Network** to share the SSID and password to others.
  - 4) Select the **Security** type and customize your own password. If **None** is selected, no password is needed to access the IoT network.

**IoT Network**  
Create a dedicated wireless network to manage your IoT devices together, such as smart lights and camera.

**2.4 GHz:**  Enable [Share Network](#)

Network Name (SSID):   Hide SSID

Security:  ▼

Password:

**5 GHz:**  Enable [Share Network](#)

Make sure your IoT devices can connect to a 5 GHz Network.

Network Name (SSID):   Hide SSID

Security:  ▼

Password:

4. Click **SAVE**. Now you can connect your IoT devices to the dedicated IoT network.

### 4.6.4. Wireless Schedule

The wireless network can be automatically off at a specific time when you do not need the wireless connection.

1. Visit <http://tplinkwifi.net>, and log in with your TP-Link ID or the password you set for the router.
2. Go to [Advanced](#) > [Wireless](#) > [Wireless Schedule](#).

### Wireless Schedule

Schedule when to automatically turn off your wireless network.

**Wireless Schedule:**  Enable

**Note:** Make sure [Time Settings](#) are correct before using this function.

Current Time: 23/09/2024 01:29:33

[+ Add](#)

Wireless Off Time	Repeat	Modify
No Entries in this table.		

3. Tick the [Enable](#) checkbox to enable the wireless schedule function.
4. Click [Add](#) to specify a wireless off period during which you need the wireless off automatically, and click [SAVE](#).

**Add Schedule** ✕

Wireless Off Time: From  To  (next day)

Repeat:  S  M  T  W  T  F  S

5. The wireless schedules added will appear in the list. You can modify the settings here.

[+ Add](#)

Wireless Off Time	Repeat	Modify
23:00-7:00 (next day)	Mon, Tue, Wed, Thu, Fri, Sat	<a href="#">✎</a> <a href="#">✖</a>
20:00-21:00	Every Day	<a href="#">✎</a> <a href="#">✖</a>

**Note:**

- The Effective Time Schedule is based on the time of the router. You can go to [Advanced](#) > [System](#) > [Time & Language](#) to modify the time.
- The wireless network will be automatically turned on after the time period you set.

### 4.6.5. WPS

WPS (Wi-Fi Protected Setup) can help you to quickly and securely connect to a network. This section will guide you to add a new wireless device to your router's network quickly via WPS.

**Note:**

The WPS function cannot be configured if the wireless function of the router is disabled. Please make sure the wireless function is enabled before configuration.

1. Visit <http://tplinkwifi.net>, and log in with your TP-Link ID or the password you set for the router.
2. Go to [Advanced > Wireless > WPS](#).
3. Click to enable the WPS function.
4. Follow one of the following methods to connect your client device to the router's Wi-Fi network.

- **Connect via the Client's PIN**

1. Select [Client's PIN](#).
2. Enter the PIN of your device and click [CONNECT](#). Then your device will get connected to the router.

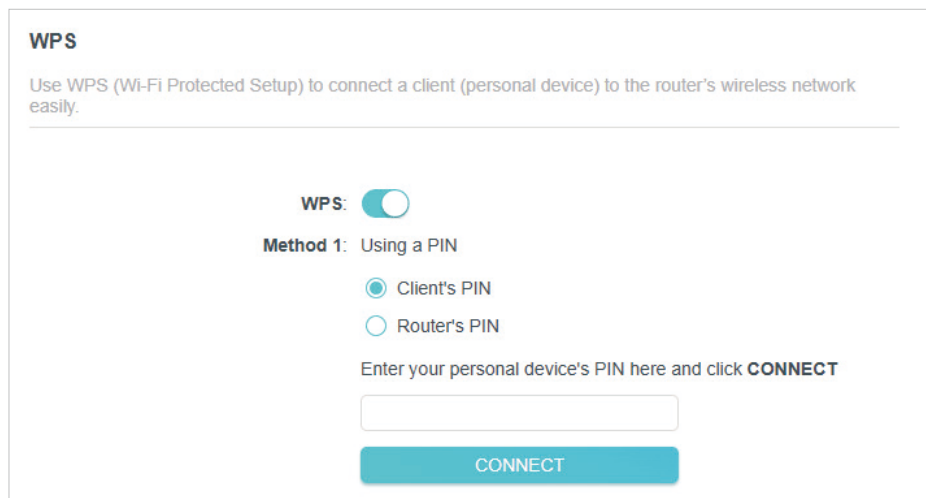

The screenshot shows the WPS configuration interface. At the top, it says 'WPS' and 'Use WPS (Wi-Fi Protected Setup) to connect a client (personal device) to the router's wireless network easily.' Below this, there is a toggle switch for 'WPS' which is turned on. Underneath, it says 'Method 1: Using a PIN'. There are two radio button options: 'Client's PIN' (which is selected) and 'Router's PIN'. Below the radio buttons, there is a text input field and a 'CONNECT' button.

- **Connect via the Router's PIN**

1. Select [Router's PIN](#).
2. Enable [Router's PIN](#). You can click [GET NEW PIN](#) to generate a new one or click [DEFAULT](#) to use the default PIN.
3. Enter the router's PIN on your personal device.

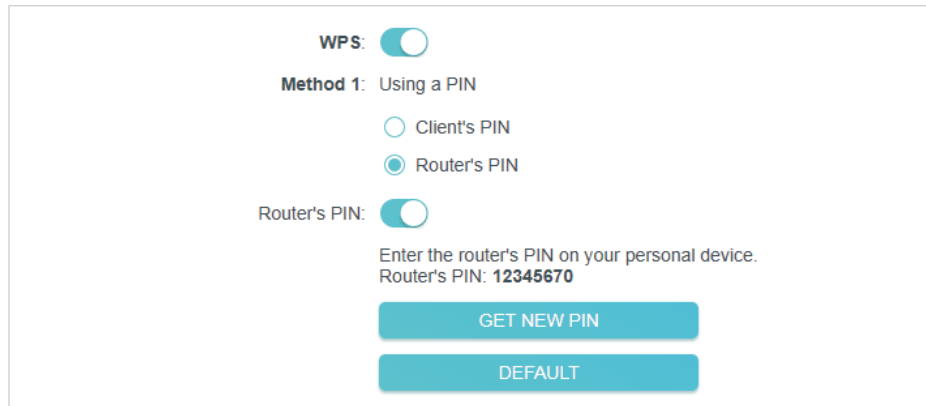

**WPS:**

**Method 1:** Using a PIN

Client's PIN

Router's PIN

**Router's PIN:**

Enter the router's PIN on your personal device.  
Router's PIN: **12345670**

**GET NEW PIN**

**DEFAULT**

Note:

PIN (Personal Identification Number) is an eight-character identification number preset to each router. WPS supported devices can connect to your router with the PIN. The default PIN is printed on the label of the router.

- **Push the WPS Button**

1. Click the **Start** button on the screen or directly press the router's WPS button. Within two minutes, press the WPS button on your client device.
2. A success message will appear on the page if the client device has been successfully added to the router's network. And the Wi-Fi LED of the router should change from flashing to solid on, indicating successful WPS connection.

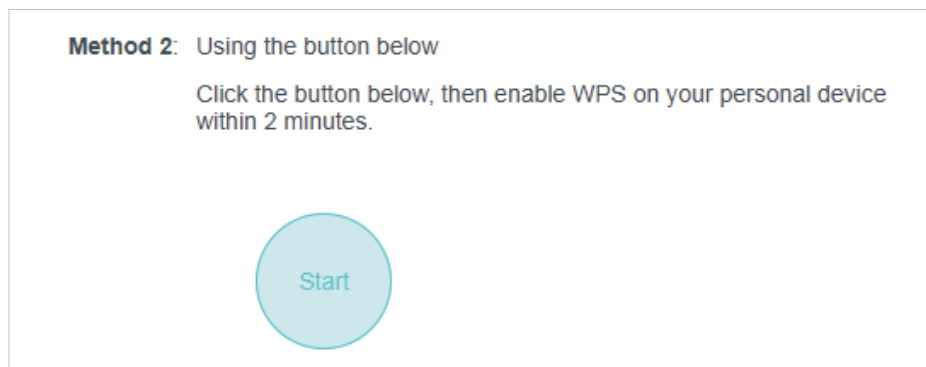

**Method 2:** Using the button below

Click the button below, then enable WPS on your personal device within 2 minutes.

**Start**

#### 4. 6. 6. Advanced Wireless Settings

Check advanced wireless settings for your device.

1. Visit <http://tplinkwifi.net>, and log in with your TP-Link ID or the password you set for the router.
2. Go to **Advanced > Wireless > Additional Settings**.

### Additional Settings

Check advanced wireless settings for your device.

---

WMM:  Enable

Short GI:  Enable

AP Isolation:  Enable

Beacon Interval:

RTS Threshold:

DTIM Interval:

Group Key Update Period:  s

- **WMM** - WMM (Wi-Fi multimedia) function can guarantee the packets with high-priority messages being transmitted preferentially.
- **Short GI** - It is recommended to enable Short GI (Short Guard Interval) function, for it will increase the data capacity by reducing the guard interval time.
- **AP Isolation** - This function isolates all connected wireless stations so that wireless stations cannot access each other through WLAN.
- **Beacon Interval** - Enter a value between 40 and 1000 in milliseconds to determine the duration between beacon packets that are broadcasted by the router to synchronize the wireless network. The default value is 100 milliseconds.
- **RTS Threshold**- Enter a value between 1 and 2346 to determine the packet size of data transmission through the router. By default, the RTS (Request to Send) Threshold size is 2346. If the packet size is greater than the preset threshold, the router will send RTS frames to a particular receiving station and negotiate the sending of a data frame.
- **DTIM Interval** - The value determines the interval of DTIM (Delivery Traffic Indication Message). Enter a value between 1 and 15 intervals. The default value is 1, which indicates the DTIM Interval is the same as Beacon Interval.
- **Group Key Update Period** - Enter a number of seconds (minimum 30) to control the time interval for the encryption key automatic renewal. The default value is 0, meaning no key renewal.

## 4.7. NAT Forwarding

The router's NAT (Network Address Translation) feature makes devices on the LAN use the same public IP address to communicate with devices on the internet, which protects the local network by hiding IP addresses of the devices. However, it also brings about the problem that an external host cannot initiatively communicate with a specified device on the local network.

With the forwarding feature the router can penetrate the isolation of NAT and allows devices on the internet to initiatively communicate with devices on the local network, thus realizing some special functions.

The TP-Link router supports four forwarding rules. If two or more rules are set, the priority of implementation from high to low is Port Forwarding, Port Triggering, UPNP and DMZ.

### 4.7.1. Share Local Resources on the Internet by Port Forwarding

When you build up a server on the local network and want to share it on the internet, Port Forwarding can realize the service and provide it to internet users. At the same time Port Forwarding can keep the local network safe as other services are still invisible from the internet.

Port Forwarding can be used for setting up public services on your local network, such as HTTP, FTP, DNS, POP3/SMTP and Telnet. Different services use different service ports. Port 80 is used in HTTP service, port 21 in FTP service, port 25 in SMTP service and port 110 in POP3 service. Please verify the service port number before the configuration.

#### I want to:

Share my personal website I've built in local network with my friends through the internet.

**For example**, the personal website has been built on my home PC (192.168.0.100). I hope that my friends on the internet can visit my website in some way. The PC is connected to the router with the WAN IP address 218.18.232.154.

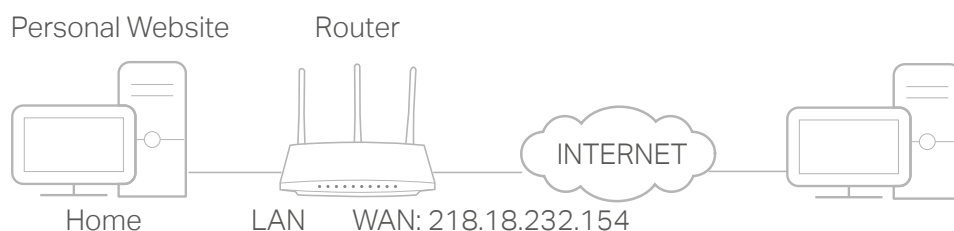

#### How can I do that?

1. Assign a static IP address to your PC, for example 192.168.0.100.
2. Visit <http://tplinkwifi.net>, and log in with your TP-Link ID or the password you set for the router.
3. Go to **Advanced > NAT Forwarding > Port Forwarding**.
4. Click **+ Add**.

**Port Forwarding**

Specify ports to make specific devices or services on your local network accessible over the internet.

[+ Add](#)

Service Name	Device IP Address	External Port	Internal Port	Protocol	Status	Modify
No Entries in this table.						

5. Click [VIEW COMMON SERVICES](#) and select [HTTP](#). The [External Port](#), [Internal Port](#) and [Protocol](#) will be automatically filled in.
6. Click [VIEW CONNECTED DEVICES](#) and select your home PC. The [Device IP Address](#) will be automatically filled in. Or enter the PC's IP address 192.168.0.100 manually in the [Device IP Address](#) field.
7. Click [SAVE](#).

**Add a Port Forwarding Entry** ✕

Service Name:

[VIEW COMMON SERVICES](#)

Device IP Address:

[VIEW CONNECTED DEVICES](#)

External Port:

Internal Port:

Protocol:

Enable This Entry

[CANCEL](#) [SAVE](#)

**Tips:**

- It is recommended to keep the default settings of [Internal Port](#) and [Protocol](#) if you are not clear about which port and protocol to use.
- If the service you want to use is not in the common services list, you can enter the corresponding parameters manually. You should verify the port number that the service needs.
- You can add multiple port forwarding rules if you want to provide several services in a router. Please note that the [External Port](#) should not be overlapped.

**Done!**

Users on the internet can enter [http:// WAN IP](#) (in this example: [http:// 218.18.232.154](#))

to visit your personal website.

 **Tips:**

- The WAN IP should be a public IP address. For the WAN IP is assigned dynamically by the ISP, it is recommended to apply and register a domain name for the WAN referring to [Set Up a Dynamic DNS Service Account](#). Then users on the internet can use [http:// domain name](http://domain name) to visit the website.
- If you have changed the default [External Port](#), you should use <http:// WAN IP: External Port> or <http:// domain name: External Port> to visit the website.

## 4.7.2. Open Ports Dynamically by Port Triggering

Port Triggering can specify a triggering port and its corresponding external ports. When a host on the local network initiates a connection to the triggering port, all the external ports will be opened for subsequent connections. The router can record the IP address of the host. When the data from the internet return to the external ports, the router can forward them to the corresponding host. Port Triggering is mainly applied to online games, VoIPs, video players and common applications including MSN Gaming Zone, Dialpad and Quick Time 4 players, etc.

Follow the steps below to configure the Port Triggering rules:

1. Visit <http://tplinkwifi.net>, and log in with your TP-Link ID or the password you set for the router.
2. Go to [Advanced](#) > [NAT Forwarding](#) > [Port Triggering](#) and click  [Add](#).

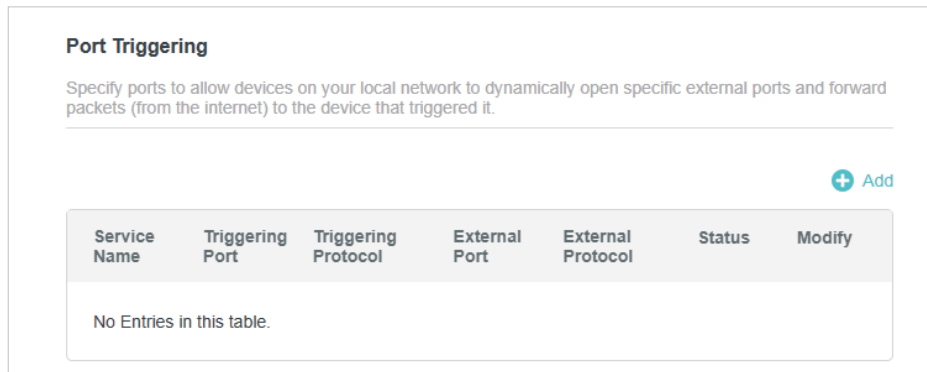

3. Click [VIEW COMMON SERVICES](#), and select the desired application. The [Triggering Port](#), [Triggering Protocol](#) and [External Port](#) will be automatically filled in. The following picture takes application [MSN Gaming Zone](#) as an example.

#### 4. Click **SAVE**.

##### Tips:

- You can add multiple port triggering rules according to your network need.
- The triggering ports can not be overlapped.
- If the application you need is not listed in the Existing Applications list, please enter the parameters manually. You should verify the external ports the application uses first and enter them into [External Port](#) field according to the format the page displays.

### 4.7.3. Make Xbox Online Games Run Smoothly by UPnP

The UPnP (Universal Plug and Play) protocol allows applications or host devices to automatically find the front-end NAT device and send request to it to open the corresponding ports. With UPnP enabled, the applications or host devices on the local network and the internet can freely communicate with each other thus realizing the seamless connection of the network. You may need to enable the UPnP if you want to use applications for multiplayer gaming, peer-to-peer connections, real-time communication (such as VoIP or telephone conference) or remote assistance, etc.

##### Tips:

- UPnP is enabled by default in this router.
- Only the application supporting UPnP protocol can use this feature.
- UPnP feature needs the support of operating system (e.g. Windows Vista/ Windows 7/ Windows 8, etc. Some of operating system need to install the UPnP components).

**For example**, when you connect your Xbox to the router which has connected to the internet to play online games, UPnP will send request to the router to open the corresponding ports allowing the following data penetrating the NAT to transmit. Therefore, you can play Xbox online games without a hitch.

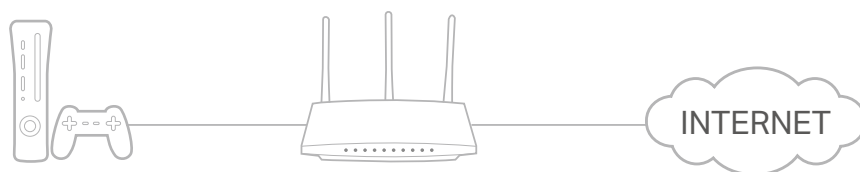

If necessary, you can follow the steps to change the status of UPnP.

1. Visit <http://tplinkwifi.net>, and log in with your TP-Link ID or the password you set for the router.
2. Go to **Advanced > NAT Forwarding > UPnP** and toggle on or off according to your needs.

**UPnP**

Enable UPnP (Universal Plug and Play) to allow devices on your local network to dynamically open ports for applications such as multiplayer gaming and real-time communications.

UPnP:

**UPnP Client List**

Displays the UPnP device information.

Total Clients: 0 [Refresh](#)

Service Description	Client IP Address	Internal Port	External Port	Protocol
No Entries in this table.				

#### 4.7.4. Make Applications Free from Port Restriction by DMZ

When a PC is set to be a DMZ (Demilitarized Zone) host on the local network, it is totally exposed to the internet, which can realize the unlimited bidirectional communication between internal hosts and external hosts. The DMZ host becomes a virtual server with all ports opened. When you are not clear about which ports to open in some special applications, such as IP camera and database software, you can set the PC to be a DMZ host.

**Note:**

When DMZ is enabled, the DMZ host is totally exposed to the internet, which may bring some potential safety hazards. If DMZ is not in use, please disable it in time.

#### I want to:

Make the home PC join the internet online game without port restriction.

**For example,** due to some port restriction, when playing the online games, you can log in normally but cannot join a team with other players. To solve this problem, set your PC

as a DMZ host with all ports open.

### How can I do that?

1. Assign a static IP address to your PC, for example 192.168.0.100.
2. Visit <http://tplinkwifi.net>, and log in with your TP-Link ID or the password you set for the router.
3. Go to [Advanced](#) > [NAT Forwarding](#) > [DMZ](#) and tick to enable DMZ.
4. Click [VIEW CONNECTED DEVICES](#) and select your PC. The [Device IP Address](#) will be automatically filled in. Or enter the PC's IP address 192.168.0.100 manually in the [DMZ Host IP Address](#) field.

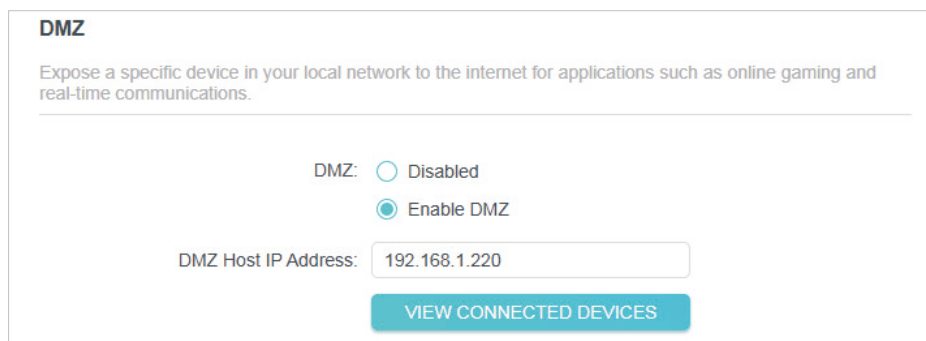

**DMZ**

Expose a specific device in your local network to the internet for applications such as online gaming and real-time communications.

DMZ:  Disabled  
 Enable DMZ

DMZ Host IP Address:

[VIEW CONNECTED DEVICES](#)

5. Click [SAVE](#).

### Done!

The configuration is completed. You've set your PC to a DMZ host and now you can make a team to game with other players.

## 4.8. Parental Controls

Parental Controls allows you to set up unique restrictions on internet access for each member of your family. You can block inappropriate content, set daily limits for the total time spent online and restrict internet access to certain times of the day.

1. Visit <http://tplinkwifi.net>, and log in with your TP-Link ID or the password you set for the router.
2. Go to [Advanced](#) > [Advanced](#) > [Parental Controls](#).
3. Click [+](#) [Add](#) to create a profile for a family member.

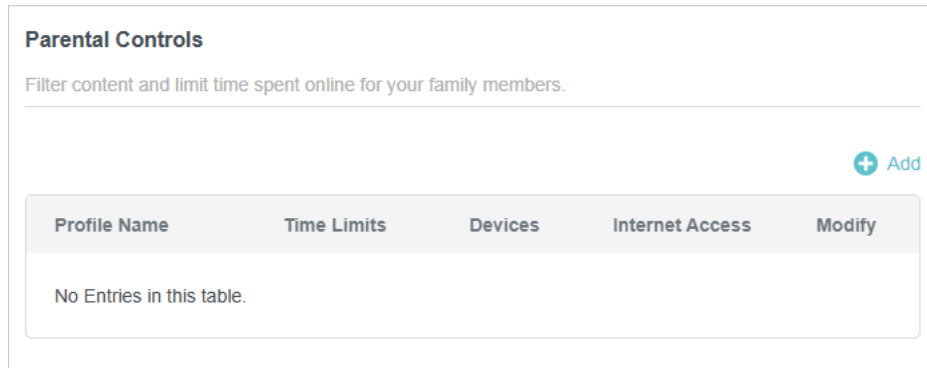

#### 4. Add basic profile information.

- 1) Enter a **Name** for the profile to make it easier to identify.
- 2) Click **+ Add** and select the devices that belong to this family member. Access restrictions will be applied to these devices. Click **Add** when finished.

Note: Only devices that have previously been connected to your router's network are listed here. If you are unable to find the device you want to add, connect it to your network and then try again.

- 3) Click **NEXT**

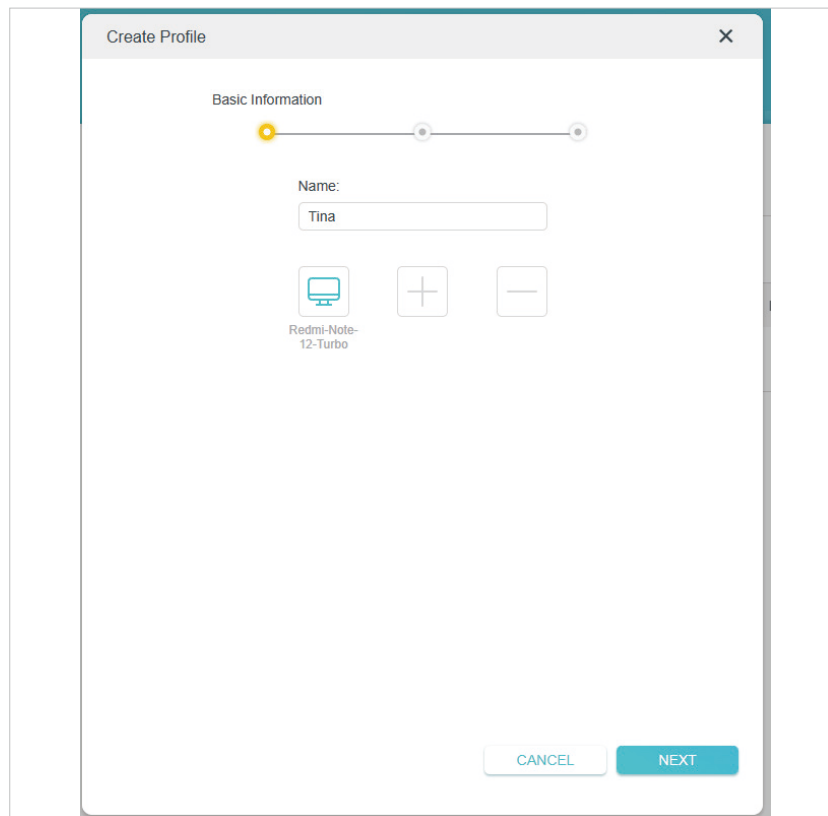

#### 5. Block content for this profile.

- 1) Select the content categories to block in the **Content Filter** list.
- 2) You can also block a specific website. Enter a keyword (for example, "Facebook") or a URL (for example, "www.facebook.com"), then click **Add**.

3) Click **NEXT**.

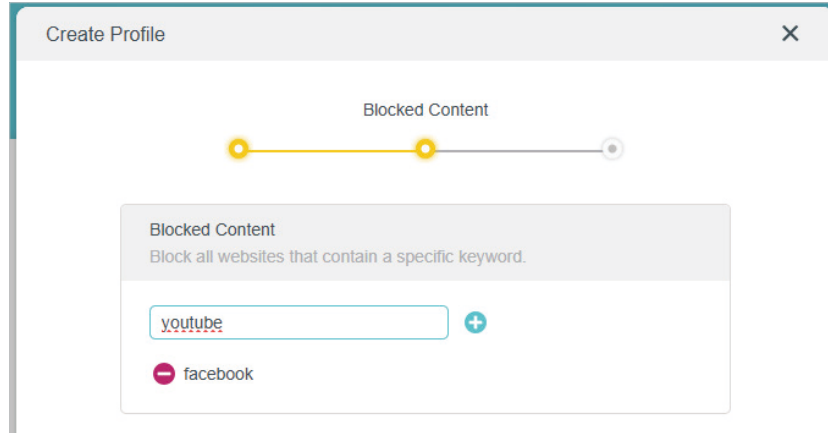

6. Set time restrictions on internet access.

- 1) Set daily **Time Limits** for the total time spent online. You can set daily time limits for **Mon to Fri** and **Sat & Sun** separately.
- 2) Set **Bed Time** to block internet access between certain times. Devices under this profile will be unable to access the internet during this time period. You can set bed time for **School Nights** and **Weekend** separately.
- 3) Click **SAVE**.

The screenshot shows the 'Create Profile' window with the following settings:

- Time Controls:** A visual timeline with three yellow dots.
- Time Limits:**
  - Mon to Fri:
  - Daily Time Limit: 2 hours
  - Sat & Sun:
- Bed Time:**
  - School Nights: (Sun to Thur) 
    - Good Night: 22 : 00
    - Good Morning: 07 : 00
  - Weekend: (Fri & Sat) 
    - Good Night: 22 : 00
    - Good Morning: 07 : 00

Buttons: BACK, SAVE

- 4) After adding a profile, you can pause or restore the network connection for this profile anytime.

**Parental Controls**  
Filter content and limit time spent online for your family members.

+ Add

Profile Name	Time Limits	Devices	Internet Access	Modify
Tina	2 hours	2		
Tim	2 hours	1	 Paused	

## 4.9. QoS

QoS (Quality of Service) allows you to prioritize connection of specific devices for a set duration. Devices set as high priority will be allocated more bandwidth and so continue to run smoothly even when there is heavy traffic on the network.

1. Visit <http://tplinkwifi.net>, and log in with your TP-Link ID or the password you set for the router.
2. Go to **Advanced > Advanced > QoS**.
3. Enable **QoS** to set the total bandwidth. Then click **SAVE**.
4. Enable **Priority** for the desired device and select its effective time in the **Timing** dropdown list.

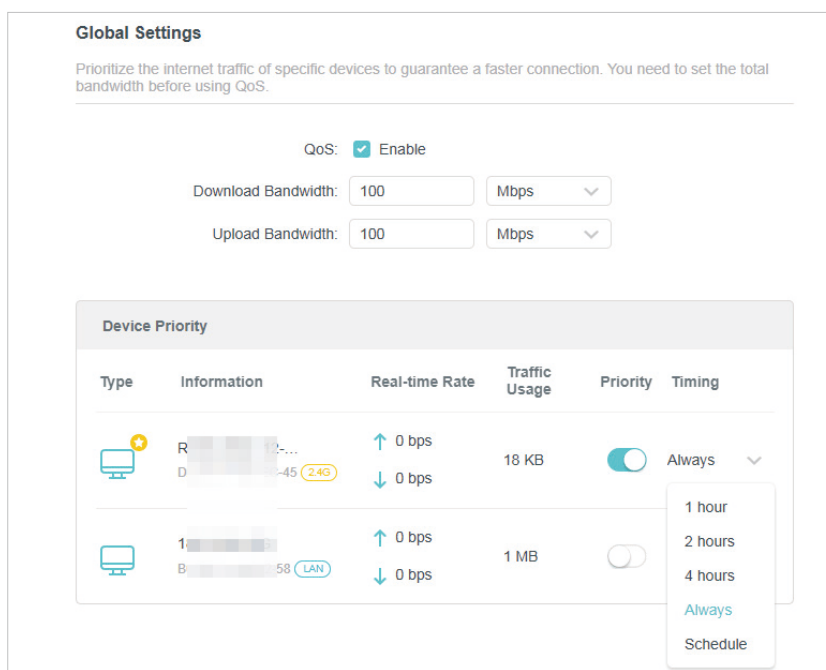

## 4. 10. Network Security

This chapter guides you on how to protect your home network from cyber attacks and unauthorized users by implementing these three network security functions. You can protect your home network from cyber attacks, block or allow specific client devices to access your network using Access Control, you can prevent ARP spoofing and ARP attacks using IP & MAC Binding, protect your network security by isolating your IoT devices.

### 4. 10. 1. Protect the Network from Cyber Attacks

The SPI (Stateful Packet Inspection) Firewall protects the router from cyber attacks and validate the traffic that is passing through the router based on the protocol. This function is enabled by default.

1. Visit <http://tplinkwifi.net>, and log in with your TP-Link ID or the password you set for the router.

2. Go to [Advanced](#) > [Security](#) > [Firewall](#). It's recommended to keep the default settings.

**Firewall**

Check the settings of the firewall that protects your network. It is recommended to keep them as default.

---

SPI Firewall:

Respond to Pings from LAN:

Respond to Pings from WAN:

### 4. 10. 2. Access Control

Access Control is used to block or allow specific client devices to access your network (via wired or wireless) based on a list of blocked devices (Deny List) or a list of allowed devices (Allow List).

#### I want to:

Block or allow specific client devices to access my network (via wired or wireless).

#### How can I do that?

1. Visit <http://tplinkwifi.net>, and log in with your TP-Link ID or the password you set for the router.
2. Go to [Advanced](#) > [Security](#) > [Access Control](#).
3. Toggle on to enable [Access Control](#).
4. Select the access mode to either block (recommended) or allow the device(s) in the list.

#### To block specific device(s):

- 1) Select [Deny List](#).

**Access Control**

Control the access to your network from the specified devices.

---

Access Control:

Access Mode:  Deny List  
Block access to your network from devices in the list.

Allow List

Deny List Clients: 0 + Add

Device Type	Device Name	MAC Address	Modify
No Entries in this table.			

- 2) Click  **Add** and select devices you want to block. Then click **ADD**.

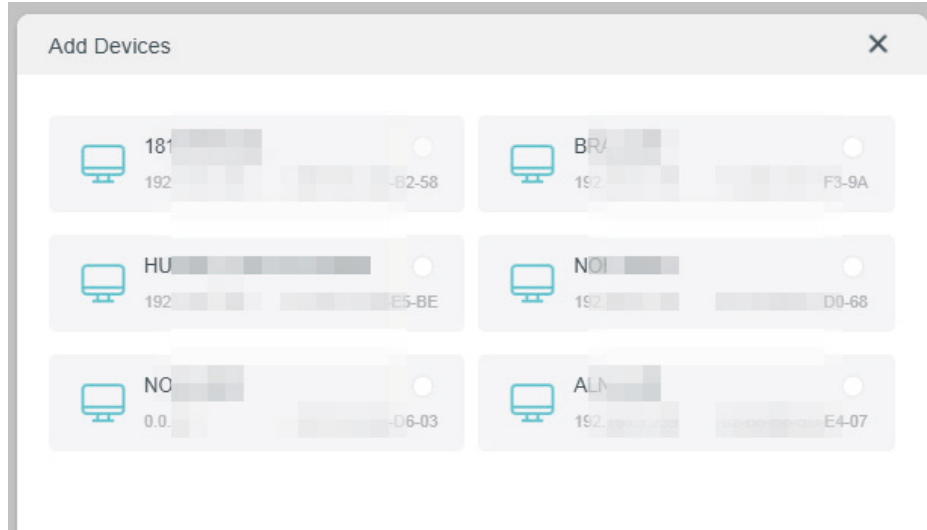

- 3) The **Operation Succeeded** message will appear on the screen, which means the selected devices have been successfully added to the Deny List.

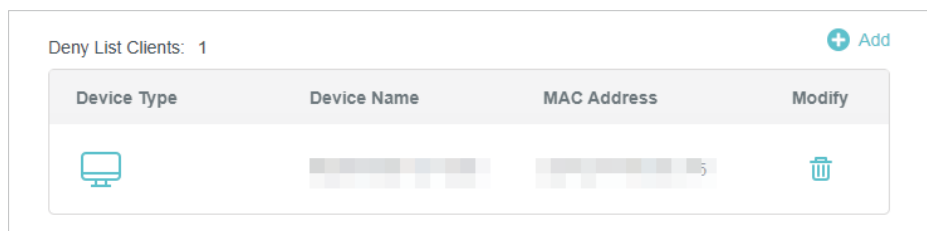

**To allow specific device(s):**

- 1) Select **Allow List**.

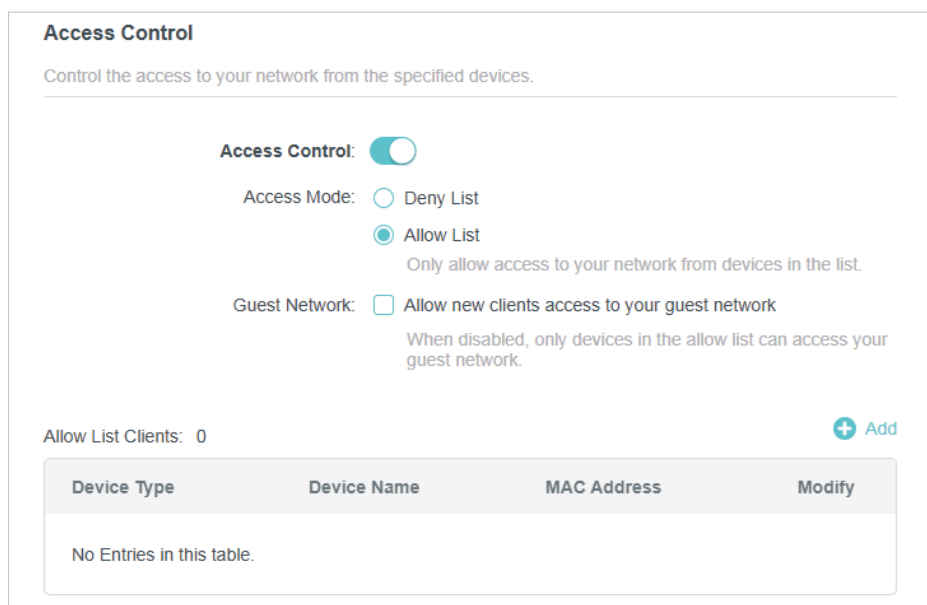

- 2) Tick the [Allow new clients access to your guest network](#) checkbox if you need. When disabled, only devices in the allow list can access your guest network.
- 3) Click [+](#) [Add](#) and select devices you want to add to the Allow List or add it manually. Then click [ADD](#).
  - Select from device list

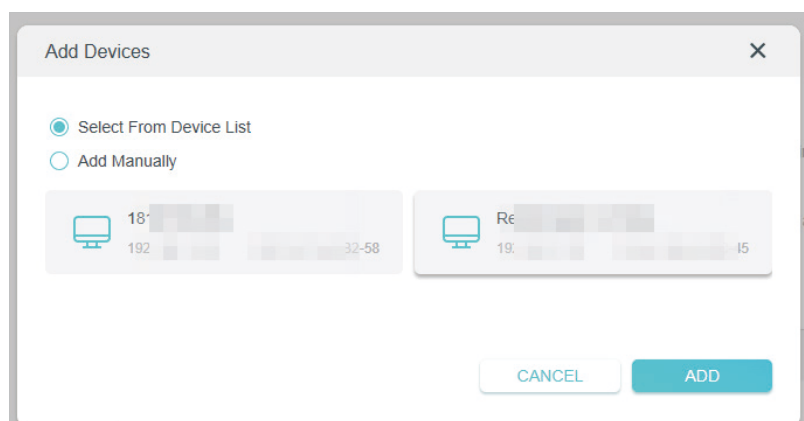

- Add manually

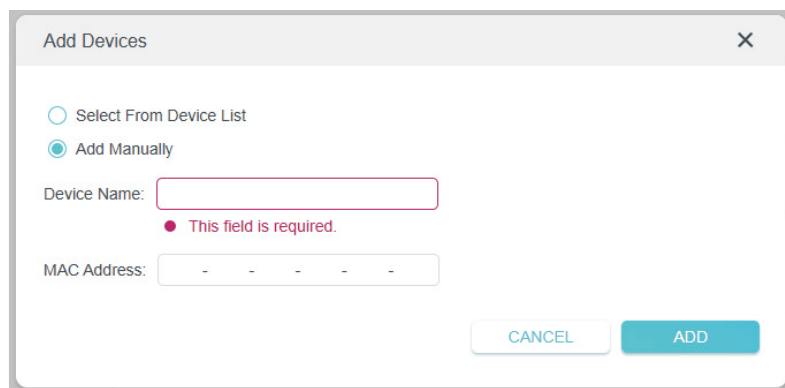

- 4) The [Operation Succeeded](#) message will appear on the screen, which means the selected devices have been successfully added to the Allow List.

## Done!

Now you can block or allow specific client devices to access your network (via wired or wireless) using the [Deny List](#) or [Allow List](#).

### 4. 10. 3. IP & MAC Binding

IP & MAC Binding, namely, ARP (Address Resolution Protocol) Binding, is used to bind network device's IP address to its MAC address. This will prevent ARP Spoofing and other ARP attacks by denying network access to an device with matching IP address in the Binding list, but unrecognized MAC address.

## I want to:

Prevent ARP spoofing and ARP attacks.

## How can I do that?

1. Visit <http://tplinkwifi.net>, and log in with your TP-Link ID or the password you set for the router.
2. Go to [Advanced](#) > [Security](#) > [IP & MAC Binding](#).
3. Enable [IP & MAC Binding](#).

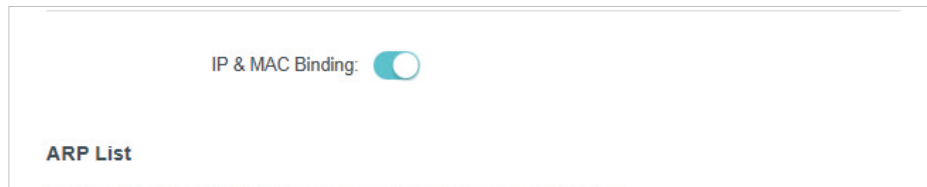

4. Bind your device(s) according to your need.

### To bind the connected device(s):

- 1) Click [+](#) [Add](#) in the [Binding List](#) section.



- 2) Click [VIEW CONNECTED DEVICES](#) and select the device you want to bind. The [MAC Address](#) and [IP Address](#) fields will be automatically filled in.

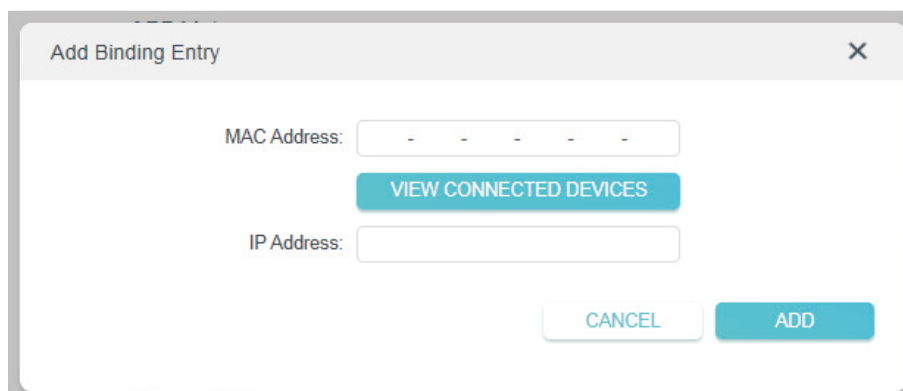

- 3) Click [SAVE](#).

**To bind the unconnected device:**

- 1) Click  **Add** in the **Binding List** section.



- 2) Enter the **MAC Address** and **IP Address** that you want to bind.
- 3) Click **SAVE**. When added, your device will appear in the Binding List and ARP List.
5. To unbind the MAC and IP addresses of a device in the list, click the **Delete** icon in the Binding List.
6. To rebind the MAC and IP addresses of a device deleted, click the toggle button of **Bind** in the ARP List.

**Done!**

Now you don't need to worry about ARP spoofing and ARP attacks!

**4. 10. 4. ALG**

ALG allows customized NAT traversal filters to be plugged into the gateway to support address and port translation for certain application layer "control/data" protocols such as FTP, TFTP, H323 etc. It is recommended to keep the default settings.

You may need to disable SIP ALG when you are using voice and video applications to create and accept a call through the router, since some voice and video communication applications do not work well with SIP ALG.

1. Visit <http://tplinkwifi.net>, and log in with your TP-Link ID or the password you set for the router.
2. Go to [Advanced](#) > [Security](#) > [ALG](#).

**ALG**

Check the ALG (Application Layer Gateway) settings. It is recommended to keep them as default.

PPTP Passthrough:

L2TP Passthrough:

IPSec Passthrough:

FTP ALG:

TFTP ALG:

RTSP ALG:

H323 ALG:

SIP ALG:

#### 4. 10. 5. IoT Security

Some devices, such as IoT devices, are vulnerable to security threats. To keep your important devices and data safe, you can isolate these devices to protect your network from being infected.

1. Visit <http://tplinkwifi.net>, and log in with your TP-Link ID or the password you set for the router.
2. Go to [Advanced](#) > [Security](#) > [IoT Security](#). Enable [IoT Security](#).

**Device Isolation**

Isolate devices(such as IoT devices) to protect your network from security threats.

Device Isolation:  ?

**Note:** We recommend disabling [AP Isolation](#) which may isolate all devices from each other.

Isolated Devices: 0 [+ Add](#)

Device Type	Device Name	MAC Address	Modify
Click Add to add devices that need to be isolated.			

3. Click [+Add](#) to add your IoT devices.

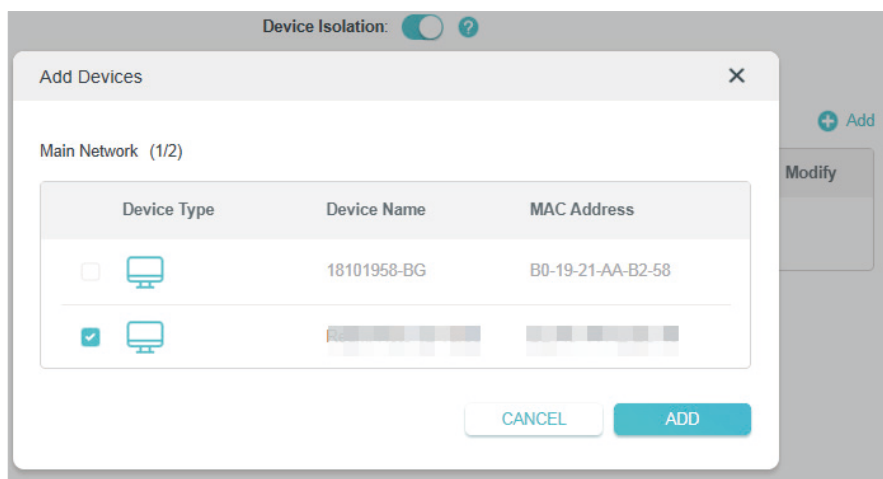

## Done!

While isolated, isolated devices (these devices) can still access the internet and communicate with other isolated devices. However, isolated devices (these devices) cannot transfer data with devices on your home, including managing gateway devices, accessing USB devices, etc.

## 4.11. IPv6

This function allows you to enable IPv6 function and set up the parameters of the router's Wide Area Network (WAN) and Local Area Network (LAN).

1. Visit <http://tplinkwifi.net>, and log in with the password you set for the router.
  2. Go to **Advanced > IPv6**, and you can view the current IPv6 status information of the router.
  3. Enable IPv6 and select the mode: Router or Pass-Through (Bridge).
- If you select **Router**:

**IPv6**

Set up an IPv6 connection if your ISP provides IPv6 service.

---

Mode: Router ▼

Fill in WAN and LAN information as required by different connection types.

- **Normal**: The default connection type.

- 1) Configure the WAN settings.

**WAN**

Configure the WAN connection based on your network topology.

WAN Connection Type:

Get IPv6 Address:

Manually set DNS server

Link-Local Address:

Global Address:

Gateway:

Primary DNS:

Secondary DNS:

2) Configure the LAN settings.

**LAN**

Configure the LAN IPv6 address of the router.

Enable Prefix Delegation:

Address Prefix:

Prefix Length:

Link-Local Address:

Prefix:

IPv6 Address:

3) Click [SAVE](#).

- **PPPoE**: Select this type if your ISP uses PPPoEv6, and provides a username and password.

1) Configure the WAN settings.

**WAN**

Configure the WAN connection based on your network topology.

WAN Connection Type:

Get IPv6 Address:

Use the same PPPoE session as IPv4 

Username:

Password:

Manually set DNS server

Link-Local Address:

Global Address:

Gateway:

Primary DNS:

Secondary DNS:

2) Configure the LAN settings.

**LAN**

Configure the LAN IPv6 address of the router.

Enable Prefix Delegation:

Address Prefix:

Prefix Length:

Link-Local Address:

Prefix:

IPv6 Address:

- **Tunnel 6to4:** Select this type if your ISP uses 6 to 4 deployment fort assigning address.

1) Configure the WAN settings.

**WAN**

Configure the WAN connection based on your network topology.

WAN Connection Type:

Manually set DNS server

Link-Local Address:

Global Address:

Gateway:

Primary DNS:

Secondary DNS:

2) Configure the LAN settings.

**LAN**

Configure the LAN IPv6 address of the router.

Link-Local Address:

Prefix:

IPv6 Address:

- If you select **Pass-Through (Bridge)**:  
Click **SAVE**. No configuration is required.

**IPv6**

Set up an IPv6 connection if your ISP provides IPv6 service.

Mode:

Select this type if your ISP uses Pass-Through (Bridge) network deployment.

## 4. 12. Smart Life Assistant

You can control your network devices using simply the power of your voice with the TP-Link Router Skill for Amazon Alexa or Google Assistant.

1. Visit <http://tplinkwifi.net>, and log in with your TP-Link ID or the password you set for the router.
2. Go to **Advanced > Smart Life Assistant** for further guidance.

### TP-Link Router Skill for Alexa

Control your network devices using simply the power of your voice with the TP-Link Router Skill for Amazon Alexa. Prioritize gaming or your game device, switch off your router's LEDs or ask Alexa to read out the password of the guest network, all without stopping what you're doing.



Follow these steps to set up Alexa control for your TP-Link router.

1. Make sure you have an Alexa device. This feature works with Amazon Echo, Amazon Tap, Echo Dot or other AVS (Alexa Voice Service) enabled devices.
2. Bind the router to your TP-Link ID. Go to **Advanced > TP-Link ID** and log in with your TP-Link ID (or register if you don't have one).
3. Open the Alexa app, then search for and enable the TP-Link Router Skill. [How to enable TP-Link Router Skill in the Alexa app.](#)
4. Download the Tether app. Open it and tap the (☰) icon, then go to **Smart Life Assistants > Alexa** and select the router you want to control.

Set up with TP-Link Tether app.



### TP-Link Router Skill for Google Assistant

Control your TP-Link router using simply the power of your voice with the TP-Link Router Skill for Google Assistant. Enable the guest network, switch off your router's LEDs, or ask Google to read out the name of your router's host network, all without stopping what you're doing.



Follow the instructions below to add the TP-Link router to your Google assistant voice service, then you can control your TP-Link router by voice using the Google Assistant or Google Home app.

1. Open the Google Assistant app, tap the profile photo, then choose Google Assistant > Home control.
2. Tap + to browse the available apps and choose TP-Link Router.
3. Follow the web instructions to sign in with your TP-Link ID.
4. You will see TP-Link Router and your smart devices on the Home control page of the Google Assistant app.

Set up with TP-Link Tether app.



[How to Link your TP-Link Router to Google Assistant](#)

## 4. 13. Manage the Router

### 4. 13. 1. Firmware Update

TP-Link aims at providing better network experience for users.

We will inform you through the web management page if there's any new firmware available for your router. Also, the latest firmware will be released at the TP-Link official website [www.tp-link.com](http://www.tp-link.com), and you can download it from the [Support](#) page for free.

Note:

- Back up your router's configurations before firmware update.
- Do NOT turn off the router during the firmware update.

- **Auto Update:**

1. Visit <http://tplinkwifi.net>, and log in with your TP-Link ID or the password you set for the router.
2. Go to [Advanced](#) > [System](#) > [Firmware Update](#).
3. Enable [Auto Update](#).

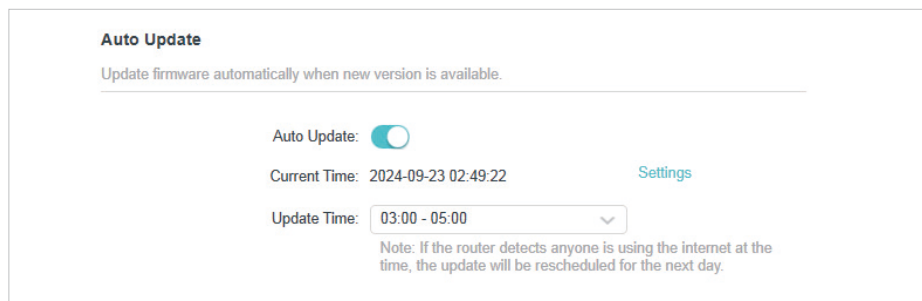

4. Specify the [Update Time](#) and save the settings.

The router will update firmware automatically at the specified time when new version is available.

- **Online Update:**

1. Visit <http://tplinkwifi.net>, and log in with your TP-Link ID or the password you set for the router.
2. Go to [Advanced](#) > [System](#) > [Firmware Update](#).
3. When the latest firmware is available for your router, the update icon  will display in the top-right corner of the page. Click the icon to go to the [Firmware Update](#) page. Alternatively, you can go to [Advanced](#) > [System](#) > [Firmware Update](#), and click **CHECK FOR UPDATES** to see whether the latest firmware is released.

4. Focus on the **Online Update** section, and click **UPDATE** if there is new firmware.

5. Wait a few minutes for the update and reboot to complete.

**Tips:** If there's a new and important firmware update for your router, you will see the prompt notification on your computer as long as a web browser is opened. Click to update, and log in to the web management page with the username and password you set for the router. You will see the **Firmware Update** page.

- **Local Update:**

1. Download the latest firmware file for the router from [www.tp-link.com](http://www.tp-link.com).
2. Visit <http://tplinkwifi.net>, and log in with your TP-Link ID or the password you set for the router.
3. Go to **Advanced > System > Firmware Update**.
4. Focus on the **Local Update** section. Click **BROWSE** to locate the downloaded new firmware file, and click **UPDATE**.

5. Wait a few minutes for the update and reboot to complete.

Note: If you fail to update the firmware for the router, please contact our [Technical Support](#).

- **EasyMesh Satellite Update:**



EasyMesh Satellite Update allows you to remotely check and update the firmware of the satellite devices connected to this router via EasyMesh.

1. Visit <http://tplinkwifi.net>, and log in with your TP-Link ID or the password you set for the router.
2. Go to [Advanced](#) > [System](#) > [Firmware Update](#), and locate the [EasyMesh Satellite Update](#) section.
3. The router's satellite devices will appear on the table. Click [CHECK FOR UPDATES](#) to see whether the latest firmware is released. If you want to update a satellite device, click  on the right of the corresponding device.

Note: The update will take a few minutes and the satellite router will reboot.

**EasyMesh Satellite Update**

Update firmware for TP-Link EasyMesh satellite routers over the internet.

Type	Device Name	Model	Firmware Version	Latest Firmware Version	Update
	EASYMESH DEVICE1	TL-WR846N	1.13.6 Build 240927 Rel. 58199n(4555)	---	

[CHECK FOR UPDATES](#)

Your firmware is up to date!

#### 4.13.2. Backup and Restore Configuration Settings

The configuration settings are stored as a configuration file in the router. You can backup the configuration file to your computer for future use and restore the router to a previous settings from the backup file when needed. Moreover, if necessary you can erase the current settings and reset the router to the default factory settings.

1. Visit <http://tplinkwifi.net>, and log in with your TP-Link ID or the password you set for the router.
2. Go to [Advanced](#) > [System](#) > [Backup & Restore](#).

- **To backup configuration settings:**

Click [BACK UP](#) to save a copy of the current settings to your local computer. A '.bin' file of the current settings will be stored to your computer.

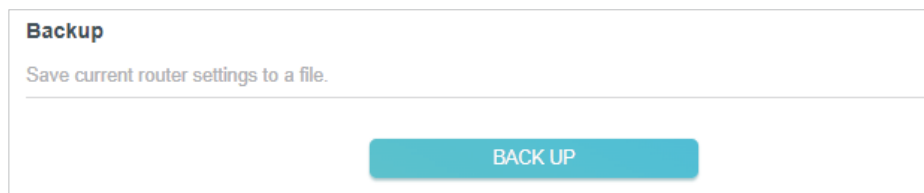

**Backup**  
Save current router settings to a file.

BACK UP

- **To restore configuration settings:**

1. Click [BROWSE](#) to locate the backup configuration file stored on your computer, and click [RESTORE](#).

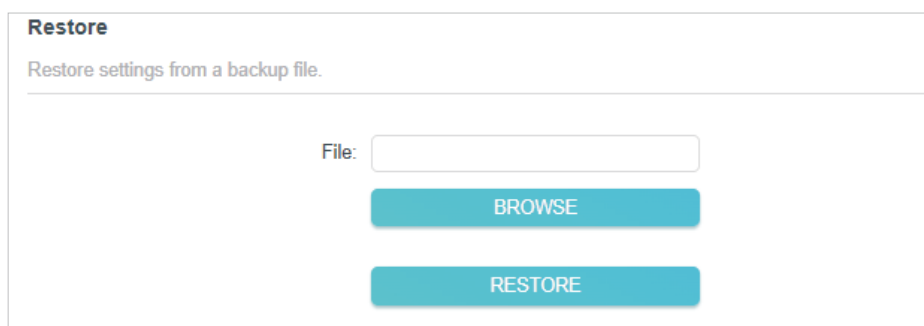

**Restore**  
Restore settings from a backup file.

File:

BROWSE

RESTORE

2. Wait a few minutes for the restoring and rebooting.

 **Note:** During the restoring process, do not turn off or reset the router.

- **To reset the router except your login password and TP-Link ID:**

1. In the [Factory Default Restore](#) section, click [RESTORE](#).

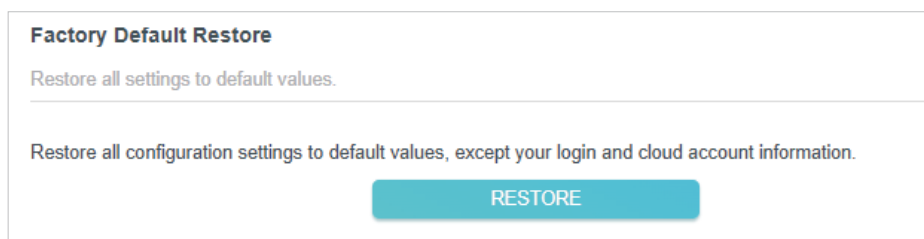

**Factory Default Restore**  
Restore all settings to default values.

Restore all configuration settings to default values, except your login and cloud account information.

RESTORE

2. Wait a few minutes for the resetting and rebooting.

 **Note:**

- During the resetting process, do not turn off the router.
- After reset, you can still use the current login password or the TP-Link ID to log in to the web management page.

- **To reset the router to factory default settings:**

1. Click [FACTORY RESTORE](#) to reset the router.

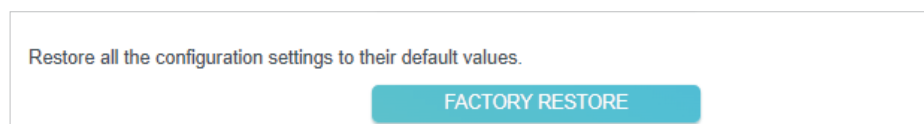

Restore all the configuration settings to their default values.

FACTORY RESTORE

2. Wait a few minutes for the resetting and rebooting.

📌 **Note:**

- During the resetting process, do not turn off or reset the router.
- We strongly recommend you backup the current configuration settings before resetting the router.

### 4.13.3. Change Password

You can change your login password of the web management page.

📌 **Note:** If you are using a TP-Link ID to log in to the web management page, the account management feature will be disabled. To manage the TP-Link ID, go to [Advanced > TP-Link ID](#).

1. Visit <http://tplinkwifi.net>, and log in with the password you set for the router.
2. Go to [Advanced > System > Administration](#) and focus on the [Change Password](#) section.

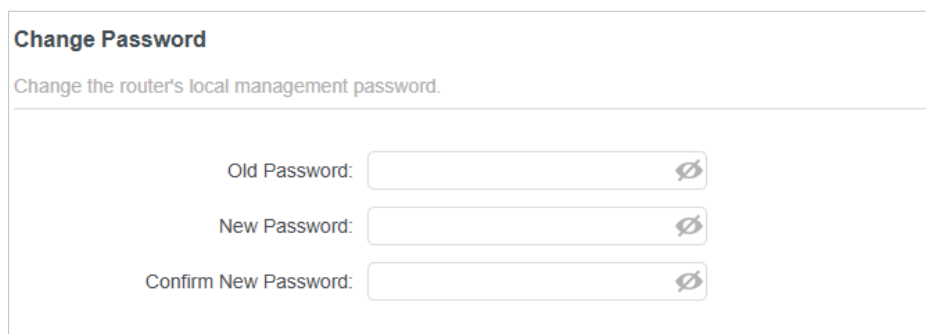

**Change Password**  
Change the router's local management password.

Old Password:

New Password:

Confirm New Password:

3. Enter the old password, then a new password twice (both case-sensitive). Click [SAVE](#).
4. Use the new password for future logins.

### 4.13.4. Local Management

This feature allows you to limit the number of client devices on your LAN from accessing the router by using the MAC address-based authentication.

1. Visit <http://tplinkwifi.net>, and log in with your TP-Link ID or the password you set for the router.
2. Go to [Advanced > System > Administration](#) and complete the settings In [Local Management](#) section as needed.

- **Local Management via HTTPS:**

Tick the [Local Management via HTTPS](#) checkbox to access the router via HTTPS and HTTP, or keep it disabled to access the router only via HTTP. Click [SAVE](#).

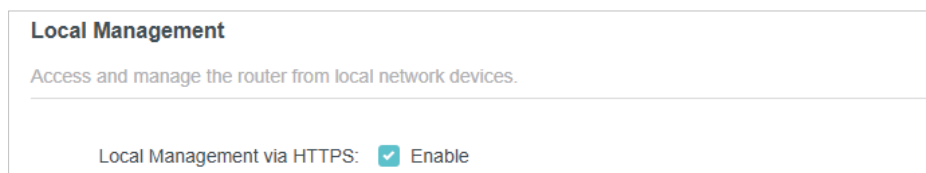

**Local Management**  
Access and manage the router from local network devices.

Local Management via HTTPS:  Enable

- **Allow all LAN connected devices to manage the router:**

Select [All Devices](#) for [Local Managers](#). Click [SAVE](#).

**Local Management**

Access and manage the router from local network devices.

---

Local Management via HTTPS:  Enable

Local Managers: All Devices ▼

- **Allow specific devices to manage the router:**

1. Select [Specified Devices](#) for [Local Managers](#).

**Local Management**

Access and manage the router from local network devices.

---

Local Management via HTTPS:  Enable

Local Managers: Specified Devices ▼

[+ Add Device](#)

Description	MAC Address	Operation
18101958-BG	B0-19-21-AA-B2-58	

2. Click [Add Device](#).

**Add Device** ✕

---

Description:

[VIEW CONNECTED DEVICES](#)

MAC Address:

CANCEL
SAVE

3. Click [VIEW CONNECTED DEVICES](#) and select the device to manage the router from the Connected Devices list, or enter the MAC address of the device manually. Click [SAVE](#). The devices added will appear in the list.

4. Click [SAVE](#).

### 4. 13. 5. Remote Management

This feature allows you to control remote devices' authority to manage the router.

1. Visit <http://tplinkwifi.net>, and log in with your TP-Link ID or the password you set for the router.
2. Go to **Advanced > System > Administration** and complete the settings in **Remote Management** section as needed.

- **Forbid all devices to manage the router remotely:**

Do not tick the **Enable** checkbox of **Remote Management**.

**Remote Management**

Access and manage the router over the internet.

---

**Note:** Remote Management is not supported when you are connected to the internet only via IPv6. If you want to use Remote Management, please make sure you have set up an IPv4 connection first.

Remote Management:  Enable

- **Allow all devices to manage the router remotely:**

**Remote Management**

Access and manage the router over the internet.

---

**Note:** Remote Management is not supported when you are connected to the internet only via IPv6. If you want to use Remote Management, please make sure you have set up an IPv4 connection first.

Remote Management:  Enable

HTTP Port:

Remote Management via HTTPS:  Enable

HTTPS Port:

Web Address for Management:

Remote Managers:  ▼

1. Tick the **Enable** checkbox of **Remote Management**. Tick the **Enable** checkbox of **Remote Management via HTTPS** if you want to allow the manager to access the router via HTTPS.
2. Keep the HTTP and HTTPS port as default settings (recommended) or enter a value between 1024 and 65535.
3. Select **All Devices** for **Remote Managers**.
4. Click **SAVE**.

Devices on the internet can log in to <https://Router's WAN IP address:port number> (such as <https://113.116.60.229:1024>) to manage the router.

 **Tips:**

- You can find the WAN IP address of the router on **Network Map > Internet**.

- The router's WAN IP is usually a dynamic IP. Please refer to [Set Up a Dynamic DNS Service Account](#), if you want to log in to the router through a domain name.

- **Allow a specific device to manage the router remotely:**

**Remote Management**

Access and manage the router over the internet.

---

**Note:** Remote Management is not supported when you are connected to the internet only via IPv6. If you want to use Remote Management, please make sure you have set up an IPv4 connection first.

Remote Management:  Enable

HTTP Port:

Remote Management via HTTPS:  Enable

HTTPS Port:

Web Address for Management:

Remote Managers:  ▼

Only this IP Address:

1. Tick the **Enable** checkbox of **Remote Management**. Tick the **Enable** checkbox of **Remote Management via HTTPS** if you want to allow the manager to access the router via HTTPS.
2. Keep the HTTP and HTTPS port as default settings (recommended) or enter a value between 1024 and 65535.
3. Select **Specified Device** for **Remote Managers**.
4. In the **Only this IP Address** field, enter the IP address of the remote device to manage the router.
5. Click **SAVE**.

Devices using this WAN IP can manage the router by logging in to <http://Router's WAN IP:port number> (such as <http://113.116.60.229:1024>).

 **Tips:** The router's WAN IP is usually a dynamic IP. Please refer to [Set Up a Dynamic DNS Service Account](#), if you want to log in to the router through a domain name.

#### 4. 13. 6. HTTP Referer Head Check

HTTP referer header check function can protect your networks against CSRF attacks.

1. Visit <http://tplinkwifi.net>, and log in with your TP-Link ID or the password you set for the router.
2. Go to **Advanced > System > Administration**, and locate the HTTP Referer Head Check section.

3. HTTP Referer Head Check is enabled by default, and it is recommended to keep the default settings. This feature protects your network against cross-site request forgery (CSRF) attacks.

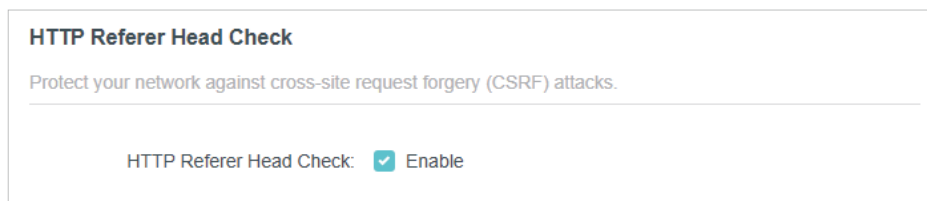

### 4.13.7. System Log

When the router does not work normally, you can save the system log and send it to the technical support for troubleshooting.

- **To save the system log locally:**
  1. Visit <http://tplinkwifi.net>, and log in your TP-Link ID or the password you set for the router.
  2. Go to **Advanced > System > System Log**.
  3. In the **Save Log** section, click **SAVE TO LOCAL** to save the system logs to a local disk.

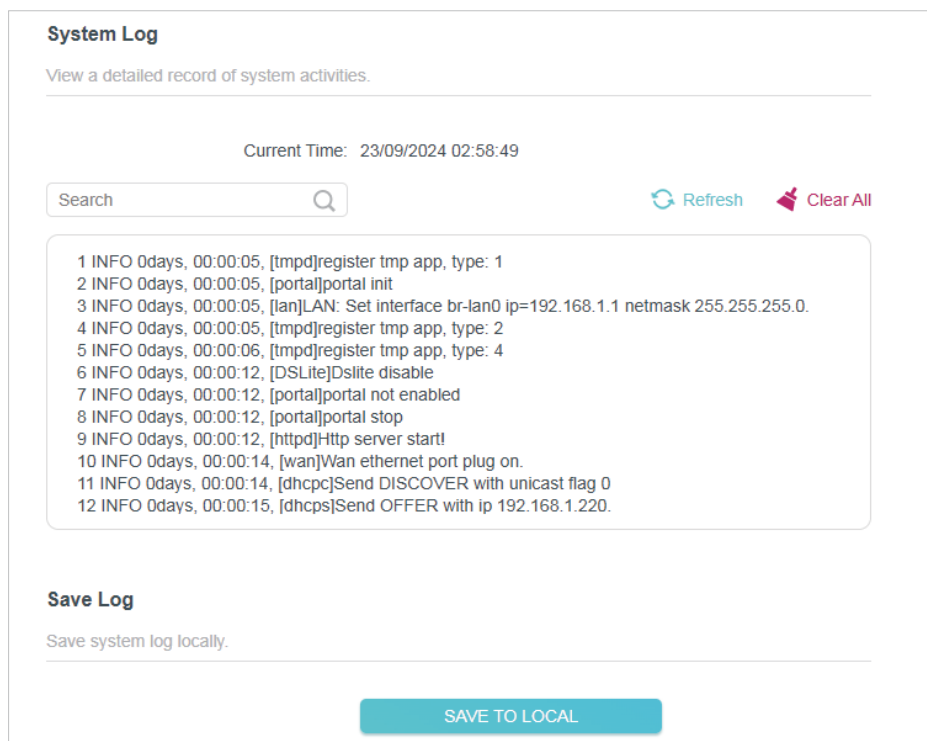

### 4.13.8. CWMP Settings

CPE WAN Management Protocol (also called TR-069) allows Auto-Configuration Server

(ACS) to perform auto-configuration, provision, connection, and diagnostics to this device. You may configure this function under your ISP's instructions.

1. Visit <http://tplinkwifi.net>, and log in your TP-Link ID or the password you set for the router.
2. Go to **Advanced > System > CWMP Settings**.
3. Configure the parameters according to your ISP's instructions, and click **SAVE**.

**CWMP Settings**

CWMP:

Inform:

Inform Interval:  (seconds)

Data Model:

ACS URL:

ACS Username:

ACS Password:

Interface used by TR-069 client:

Connection Request Authentication:

Username:

Password:

Path:

Port:

- **CWMP** - Toggle on to enable the CWMP function.
- **Inform** - Enable to send an inform message to the ACS periodically.
- **Inform Interval** - Enter the time interval when the Inform message will be sent to the ACS.
- **Data Model** - Select under your ISP's instructions the data model according to which the inform message will be sent to the ACS.
- **ACS URL** - Enter the web address of the ACS provided by your ISP.
- **ACS Username/Password** - Enter the username/password to log in to the ACS server.
- **Interface used by TR-069 client** - Select the interface to be used by the TR-069 client.
- **Connection Require Authentication** - Under your ISP's instructions, select the authentication mode. If you select **Basic** or **Digest**, enter the username and password for the ACS server to log in to the router.
- **Path** - Enter the path for the ACS server to log in to the router.

- **Port** - Enter the port that connects to the ACS server.

### 4. 13. 9. Diagnostics

Diagnostics is used to test the connectivity between the router and the host or other network devices.

1. Visit <http://tplinkwifi.net>, and log in with your TP-Link ID or the password you set for the router.
2. Go to **Advanced > System > Diagnostics**.

**Diagnostics**  
Troubleshoot network connectivity problems.

Diagnostic Tools:

IP Address/Domain Name:   
● This field is required.

Ping Packet Number:

Ping Packet Size:  Bytes

**START**

3. Enter the information:
  - 1) Choose **Ping** or **Traceroute** as the diagnostic tool to test the connectivity;
    - **Ping** is used to test the connectivity between the router and the tested host, and measure the round-trip time.
    - **Traceroute** is used to display the route (path) your router has passed to reach the tested host, and measure transit delays of packets across an Internet Protocol network.
  - 2) Enter the **IP Address** or **Domain Name** of the tested host.
  - 3) Modify the **Ping Packet Number** and the **Ping Packet Size**. It's recommended to keep the default value.
  - 4) If you have chosen **Traceroute**, you can modify the **Traceroute Max TTL**. It's recommended to keep the default value.
4. Click **START** to begin the diagnostics.

The figure below indicates the proper connection between the router and the Yahoo server (www.Yahoo.com) tested through **Ping**.

```

Finding host www.yahoo.com by DNS server (1 of 2).
Pinging www.yahoo.com [69.147.80.15] with 64 bytes of data:
Reply from 69.147.80.15: bytes=64 time=233ms TTL=47 (seq=0).
Reply from 69.147.80.15: bytes=64 time=450ms TTL=47 (seq=1).
Reply from 69.147.80.15: bytes=64 time=383ms TTL=47 (seq=2).
Reply from 69.147.80.15: bytes=64 time=250ms TTL=47 (seq=3).
Ping statistics for 69.147.80.15:
Packets: Sent = 4, Received = 4, Lost = 0 (0% loss).
Approximate round trip times in milli-seconds:
Minimum = 233ms, Maximum = 450ms, Average = 329ms

```

The figure below indicates the proper connection between the router and the Yahoo server (www.Yahoo.com) tested through [Traceroute](#).

```

Finding host www.yahoo.com by DNS server (1 of 2).
Tracing route to www.yahoo.com [69.147.80.12]
over a maximum of 30 hops:
 0  33 ms  16 ms  16 ms  192.168.194.221
 1  * * * Request timed out.
 2  100 ms  100 ms  100 ms  172.21.1.1
 3  83 ms  100 ms  100 ms  172.21.5.49
 4  * * 66 ms  172.21.5.9
 5  * 100 ms * 183.233.80.105
 6  * * 66 ms  221.183.53.97
 7  183 ms  83 ms  116 ms  221.183.167.30
 8  150 ms  150 ms  83 ms  221.183.92.214

```

#### 4.13.10. Set System Time and Language

System time is the time displayed while the router is running. The system time you configure here will be used for other time-based functions like Parental Controls. You can choose the way to obtain the system time as needed.

System language is the language displayed when you log into the router. You can change the system language as needed.

1. Visit <http://tplinkwifi.net>, and log in with your TP-Link ID or the password you set for the router.
2. Go to [Advanced](#) > [System](#) > [Time & Language](#).
  - **To get time from the internet:**
    1. Enable [24-Hour Time](#) if you want the time to display in a 24-hour way.
    2. In the [Set Time](#) field, select [Get from Internet](#).

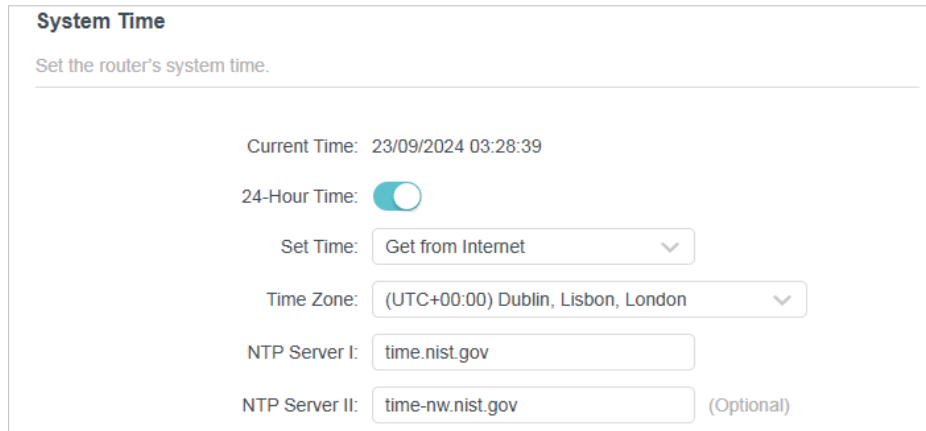

**System Time**  
Set the router's system time.

Current Time: 23/09/2024 03:28:39

24-Hour Time:

Set Time:

Time Zone:

NTP Server I:

NTP Server II:  (Optional)

3. Select your local **Time Zone** from the drop-down list.
4. In the **NTP Server I** field, enter the IP address or domain name of your desired NTP Server.
5. (Optional) In the **NTP Server II** field, enter the IP address or domain name of the second NTP Server.
6. Click **SAVE**.

- **To get time from your computer:**

1. In the **Set Time** field, select **Get from Managing Device**.

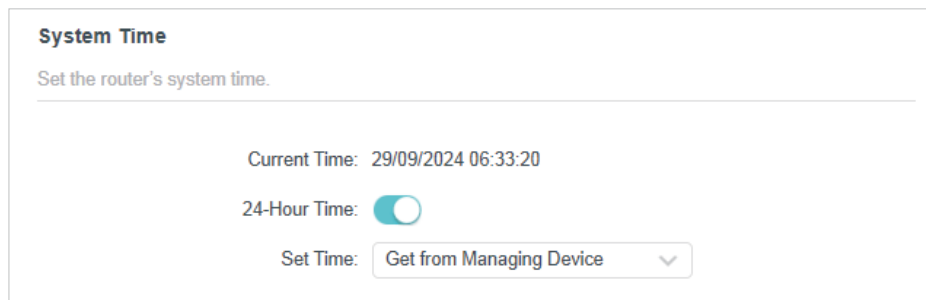

**System Time**  
Set the router's system time.

Current Time: 29/09/2024 06:33:20

24-Hour Time:

Set Time:

2. The time of your computer will then be displayed and click **SAVE**.

- **To manually set the date and time:**

1. In the **Set Time** field, select **Manually**.

**System Time**  
Set the router's system time.

Current Time: 29/09/2024 06:34:16

24-Hour Time:

Set Time: Manually

Date: 29/09/2024

Time: 06 : 32 : 41

2. Set the current **Date** (In DD/MM/YYYY format).
3. Set the current **Time** (In HH/MM/SS format).
4. Click **SAVE**.

- **To set Daylight Saving Time:**

1. Tick the **Enable** box of **Daylight Saving Time**.

**Daylight Saving Time**  
Automatically synchronize the system time with daylight saving time.

Daylight Saving Time:  Enable

Start: 2024 Mar 2nd 02:00

End: 2024 Nov First 02:00

Running Status: Daylight Saving Time is off.

2. Select the correct **Start** date and time when daylight saving time starts at your local time zone.
3. Select the correct **End** date and time when daylight saving time ends at your local time zone.
4. Click **SAVE**.

- **To set system language:**

Select the language from the dropdown list, then click **SAVE**.

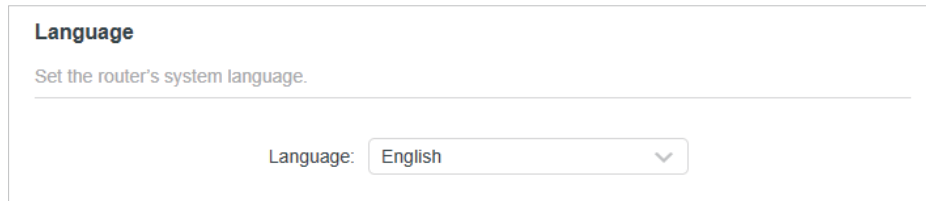

**Language**

Set the router's system language.

Language: English

## 4. 13. 11. Reboot & Reboot Schedule

- **To reboot the router:**

You can reboot the router to clear cache and enhance running performance.

1. Visit <http://tplinkwifi.net>, and log in with your TP-Link ID or the password you set for the router.
2. Go to [Advanced](#) > [System](#) > [Reboot](#).
3. Click [REBOOT](#).

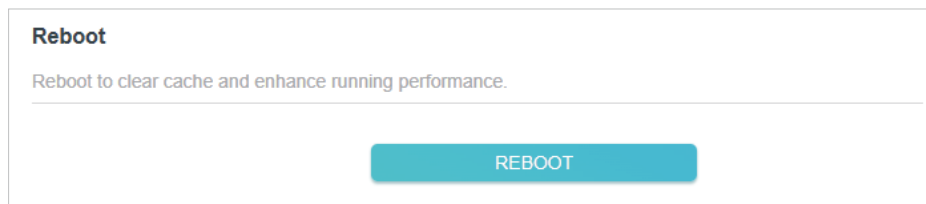

**Reboot**

Reboot to clear cache and enhance running performance.

[REBOOT](#)

- **To set reboot schedule:**

The Scheduled Reboot feature cleans the cache to enhance the running performance of the router.

1. Visit <http://tplinkwifi.net>, and log in with your TP-Link ID or the password you set for the router.
2. Go to [Advanced](#) > [System](#) > [Reboot](#).
3. Tick the [Enable](#) box of [Reboot Schedule](#).

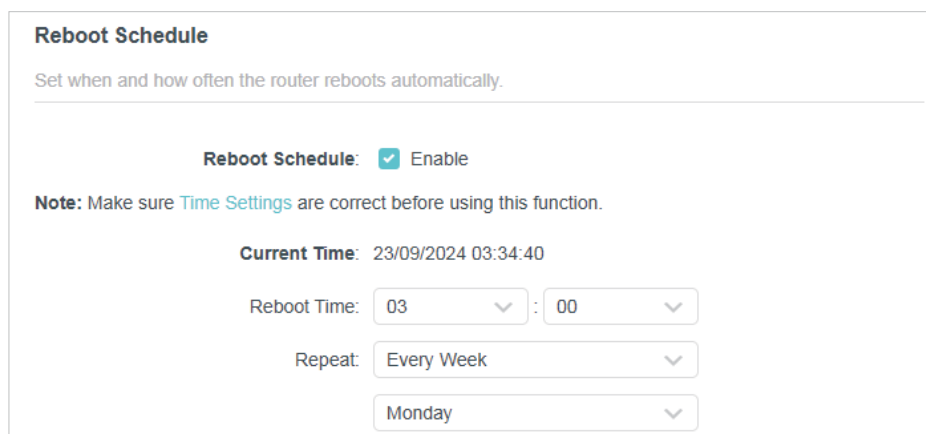

**Reboot Schedule**

Set when and how often the router reboots automatically.

**Reboot Schedule:**  Enable

**Note:** Make sure [Time Settings](#) are correct before using this function.

**Current Time:** 23/09/2024 03:34:40

Reboot Time: 03 : 00

Repeat: Every Week

Monday

4. Specify the **Reboot Time** when the router reboots and **Repeat** to decide how often it reboots.
5. Click **SAVE**.

#### 4. 13. 12. Control the LED

- **To turn off or turn on the LEDs:**

You can turn the router's LEDs on or off.

1. Visit <http://tplinkwifi.net>, and log in with your TP-Link ID or the password you set for the router.
2. Go to **Advanced > System > LED Control**.
3. Toggle the **LED Status** button to turn on or turn off the LEDs.

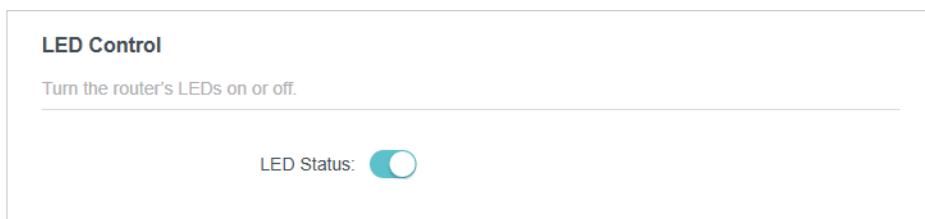

- **To enable Night Mode for the LEDs:**

The LED of the router indicates its activities and status. You can enable the Night Mode feature to specify a time period during which the LED is off.

1. Visit <http://tplinkwifi.net>, and log in with your TP-Link ID or the password you set for the router.
2. Go to **Advanced > System > LED Control**.
3. Enable **Night Mode**.
4. Specify the LED off time, and the LED will be off during this period every day.
5. Click **SAVE**.

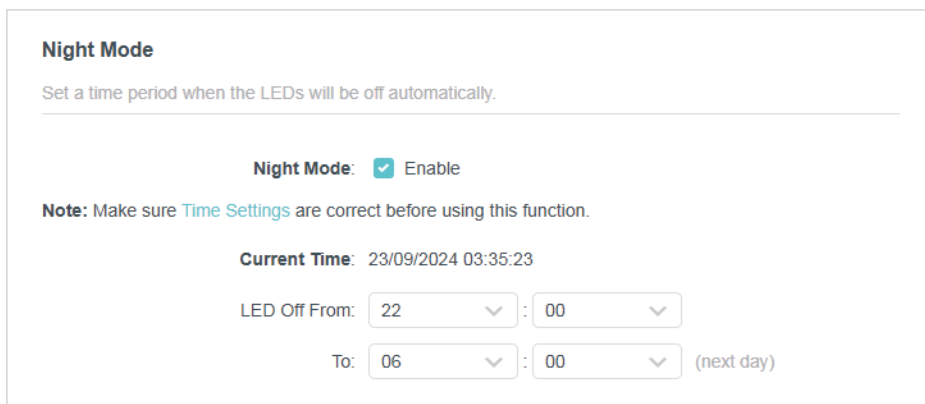

## Chapter 5

---

# Configure the Router in Access Point Mode

---

This chapter presents how to configure the various features of the router working as a wireless router.

It contains the following sections:

- [Network Map](#)
- [Operation Mode](#)
- [Network](#)
- [Wireless Settings](#)
- [Manage the Router](#)

## 5.1. Network Map

Network Map outlines device connectivity of your network visually and helps you manage general settings of the network.

1. Visit <http://tplinkwifi.net>, and log in with your TP-Link ID or the password you set for the router.
2. Go to [Network Map](#).
3. Click each network device icon to check and manage general network settings.
  - Click [Internet](#) to check internet status.

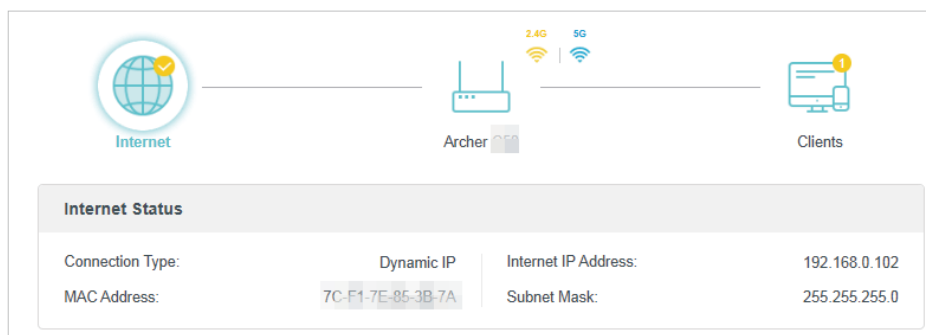

Internet Status			
Connection Type:	Dynamic IP	Internet IP Address:	192.168.0.102
MAC Address:	7C-F1-7E-85-3B-7A	Subnet Mask:	255.255.255.0

- Click the router to check device status and network settings. You can turn on or off the wireless network, guest network and IoT network, or click [Edit](#) to change related settings.

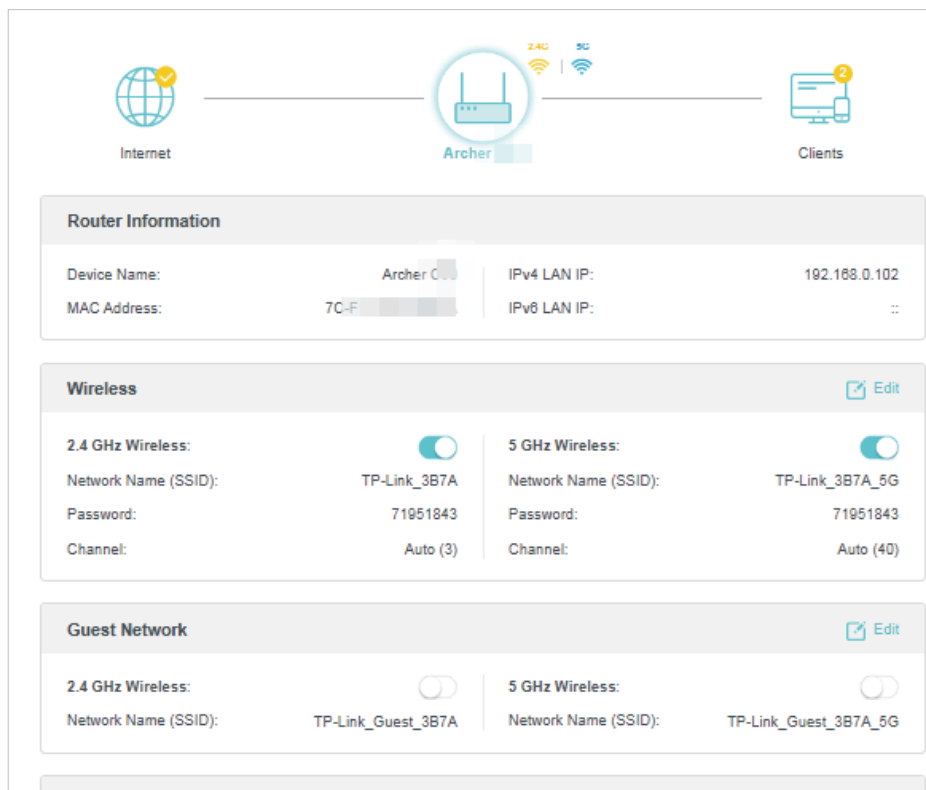

Router Information			
Device Name:	Archer C	IPv4 LAN IP:	192.168.0.102
MAC Address:	7C-F	IPv6 LAN IP:	::

Wireless <span>Edit</span>			
<b>2.4 GHz Wireless:</b> <input checked="" type="checkbox"/>		<b>5 GHz Wireless:</b> <input checked="" type="checkbox"/>	
Network Name (SSID):	TP-Link_3B7A	Network Name (SSID):	TP-Link_3B7A_5G
Password:	71951843	Password:	71951843
Channel:	Auto (3)	Channel:	Auto (40)

Guest Network <span>Edit</span>			
<b>2.4 GHz Wireless:</b> <input type="checkbox"/>		<b>5 GHz Wireless:</b> <input type="checkbox"/>	
Network Name (SSID):	TP-Link_Guest_3B7A	Network Name (SSID):	TP-Link_Guest_3B7A_5G

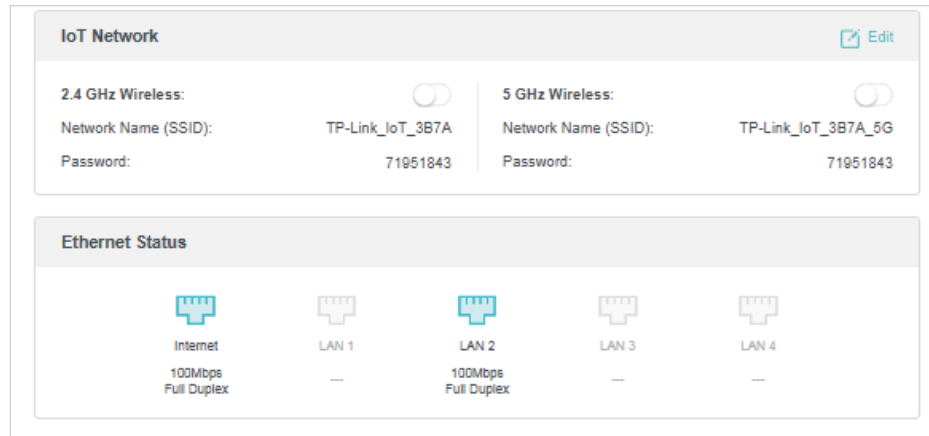

- Click [Clients](#) to view the client devices in your network. You can block devices so they cannot access your network.

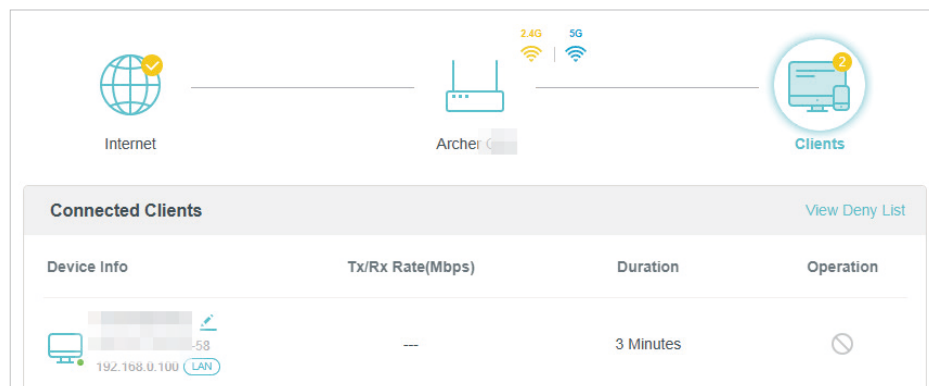

## 5.2. Operation Mode

1. Visit <http://tplinkwifi.net>, and log in with the password you set for the router.
2. Go to [Advanced > Operation Mode](#).
3. Select the working mode as needed and click [SAVE](#).

**Operation Mode**

Select an operation mode according to your needs.

Router Mode

In this mode, the router can provide internet access for multiple wired and wireless devices. This mode is required most commonly.



Access Point Mode (Current)

In this mode, the router changes an existing wired network into a wireless one.

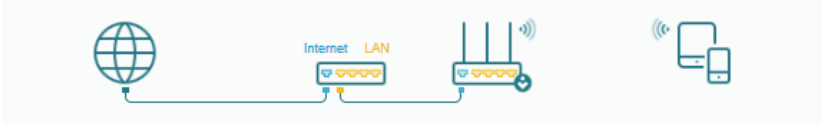

Range Extender Mode

In this mode, the router boosts the existing wireless coverage in your home.



## 5.3. Network

This chapter guides you on how to configure advanced network features.

### 5.3.1. LAN Settings

The router is preset with a default LAN IP, which you can use to log in to its web management page. The LAN IP address together with the Subnet Mask also defines the subnet that the connected devices are on. If the IP address conflicts with another device on your local network or your network requires a specific IP subnet, you can change it.

1. Visit <http://tplinkwifi.net>, and log in with your TP-Link ID or the password you set for the router.
2. Go to **Internet > LAN**.
3. Configure the IP parameters of the LAN and click **SAVE**.

### LAN

View and configure LAN settings.

---

MAC Address: D8-44-89-E8-30-80

IP Type:  Dynamic IP  
 Static IP

IP Address:

Subnet Mask:  ▼

Default Gateway:

- **MAC Address** - The physical address of the LAN ports. The value can not be changed.
- **IP Type** - Either select **Dynamic IP** to get IP address from DHCP server, or **Static IP** to configure IP address manually.
- **IP Address** - Enter the IP address in dotted-decimal notation if your select Static IP.
- **Subnet Mask** - An address code that determines the size of the network. Normally 255.255.255.0 is used as the subnet mask.
- **Default Gateway** - The Gateway currently used is shown here. Enter the Default Gateway in dotted-decimal notation if your select Static IP.

**Note:**

- If you have changed the IP address, you must use the new IP address to login.
- If you select **Dynamic IP**, the DHCP server of the router will not start up.
- If the new IP address you set is not in the same subnet as the old one, the IP Address pool in the DHCP Server will be configured.

### 5.3.2. DHCP Server Settings

When enabled, the DHCP server dynamically assigns TCP/IP parameters to client devices from the IP Address Pool. You can change the settings of the DHCP Server if necessary, and you can reserve LAN IP addresses for specified client devices.

1. Visit <http://tplinkwifi.net>, and log in with your TP-Link ID or the password you set for the router.
  2. Go to **Internet > DHCP Server**.
- **To specify the IP address that the router assigns:**

**DHCP Server**  
Dynamically assign IP addresses to the devices connected to the router.

DHCP Server:  Enable

IP Address Pool: 192.168.1.100-192.16 - 192.168.1.249

Address Lease Time: 120 minutes

Default Gateway: 0.0.0.0 (Optional)

Primary DNS: 0.0.0.0 (Optional)

Secondary DNS: 0.0.0.0 (Optional)

1. Tick the **Enable** checkbox.
  2. Enter the starting and ending IP addresses in the **IP Address Pool**.
  3. Enter the **Address Lease Time**. It is the amount of time a network user will be allowed to connect to the router with the current dynamic IP Address. When time is up, the user will be automatically assigned a new dynamic IP address. The range of the time is 1 ~ 2880 minutes.
  4. Set the **Default Gateway (Optional)**. It is suggested to input the IP address of the LAN port of the router.
  5. Set the **DNS Server (Optional)**. Input the DNS IP address provided by your ISP.
  6. Set the **Secondary DNS Server (Optional)**. Input the IP address of another DNS server if your ISP provides two DNS servers.
  7. Click **SAVE**.
- **To reserve an IP address for a specified client device:**
    1. Click **Add** in the **Address Reservation** section.

**Address Reservation**  
Reserve IP addresses for specific devices connected to the router.

[+ Add](#)

Device Name	MAC Address	Reserved IP Address	Status	Modify
No Entries in this table.				

2. Click **VIEW CONNECTED DEVICES** and select the you device you want to reserve an IP for. Then the **MAC Address** will be automatically filled in. Or enter the **MAC address** of the client device manually.

3. Enter the [IP address](#) to reserve for the client device.
4. Click [SAVE](#).

Device Name	MAC Address	Reserved IP Address	Status	Modify
		45 192.168.1.107	<input checked="" type="checkbox"/>	

- **To view devices assigned with IP addresses by the DHCP server:**

You can view the devices that are currently assigned with IP addresses by the DHCP server in [DHCP Client List](#).

Device Name	MAC Address	Assigned IP Address	Lease Time
		192.168.1.220	01:57:49
		192.168.1.107	01:58:04

### 5.3.3. Access Control

In Access Point mode, the Access Control feature is used to block specific client devices to access your network (via wired or wireless) based on a list of blocked devices (Decy List).

#### I want to:

Block specific client devices to access my network (via wired or wireless).

## How can I do that?

1. Visit <http://tplinkwifi.net>, and log in with your TP-Link ID or the password you set for the router.
2. Go to [Internet > Access Control](#).
3. Toggle on to enable [Access Control](#).

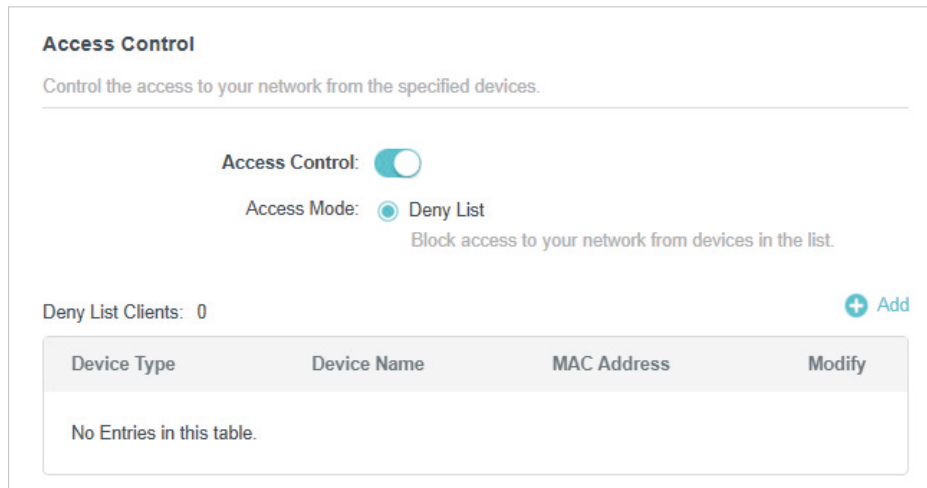

4. Click [+ Add](#) and select devices you want to block. Then click [ADD](#).

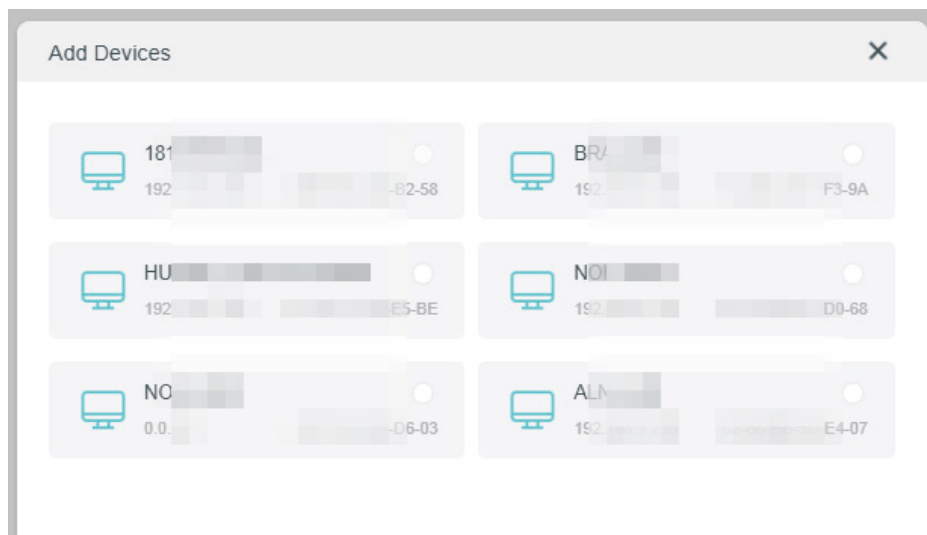

5. The Operation Succeeded message will appear on the screen, which means the selected devices have been successfully added to the Deny List.

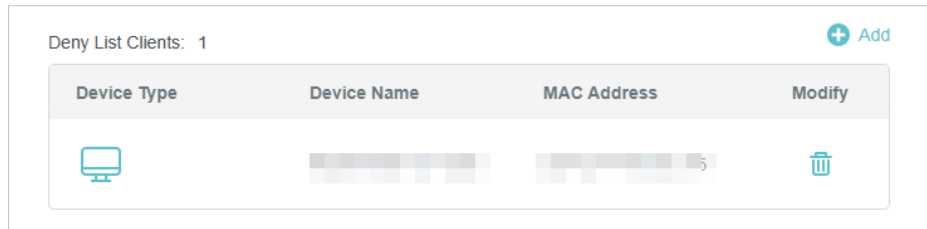

## Done!

Now you can block specific client devices to access your network (via wired or wireless) using the [Deny List](#).

## 5.4. Wireless Settings

This chapter guides you on how to configure the wireless settings.

### 5.4.1. Specify Wireless Settings

You can personalize wireless settings as you need.

1. Visit <http://tplinkwifi.net>, and log in with your TP-Link ID or the password you set for the router.
2. Go to [Wireless > Wireless Settings](#).

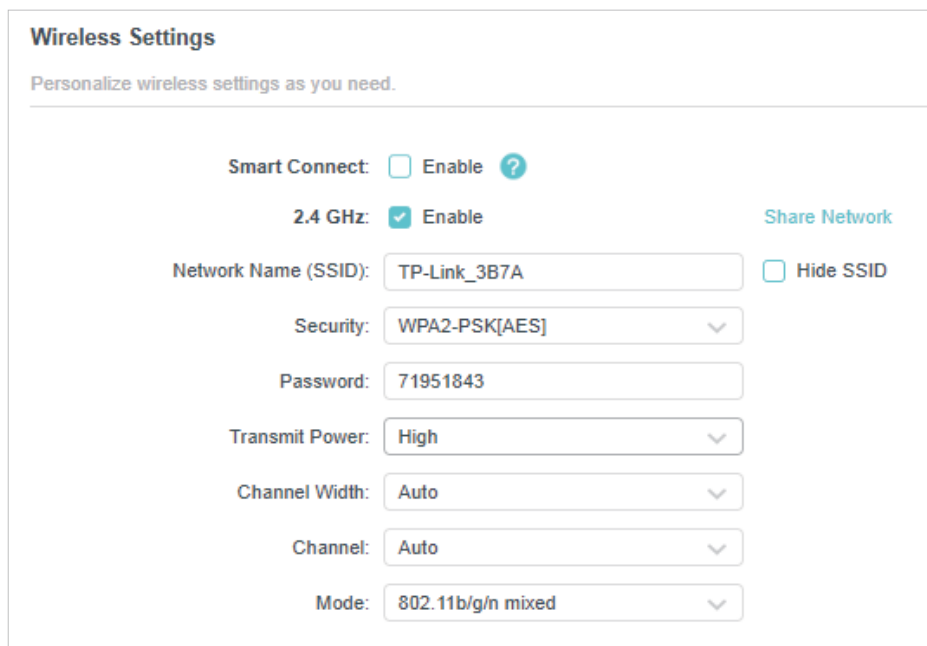

5 GHz:  Enable Share Network

Network Name (SSID):   Hide SSID

Security:  ▼

Password:

Transmit Power:  ▼

Channel Width:  ▼

Channel:  ▼

Mode:  ▼

- **To use the Smart Connect function:**

When enabled, the 2.4 GHz and 5 GHz networks share the same network name and password (only one SSID will be displayed), and your wireless device will automatically switch connection to the Wi-Fi band that provides the fastest speed.

1. Go to [Wireless > Wireless Settings](#).
2. Enable [Smart Connect](#).
3. Keep the default values or set a new SSID and password, and click [SAVE](#). This SSID and password will be applied for the 2.4 GHz and 5 GHz wireless networks. If you want to configure the wireless settings separately for each band, deselect the checkbox to disable this feature.

**Wireless Settings**

Personalize wireless settings as you need.

---

Smart Connect:  Enable Share Network

Wireless Radio:  Enable

Network Name (SSID):   Hide SSID

Security:  ▼

Password:

- **To enable or disable the wireless function:**

1. Go to [Wireless > Wireless Settings](#).
2. The wireless bands are enabled by default. If you want to disable a wireless band, just deselect its [Enable](#) checkbox.

- **To change the wireless network name (SSID) and wireless password:**

1. Go to [Wireless > Wireless Settings](#).

2. Create a new SSID in [Network Name \(SSID\)](#) and customize the password for the network in [Password](#). The value is case-sensitive.

 **Note:** If you change the wireless settings with a wireless device, you will be disconnected when the settings are effective. Please write down the new SSID and password for future use.

- **To hide SSID:**

1. Go to [Wireless > Wireless Settings](#).
2. Select [Hide SSID](#), and your SSID won't display when you scan for local wireless networks on your wireless device and you need to manually join the network.

- **To change the security option:**

1. Go to [Wireless > Wireless Settings](#).
2. Select an option from the [Security](#) drop-down list. We recommend you don't change the default settings unless necessary.

- **To change the transmit power:**

1. Go to [Wireless > Wireless Settings](#).
2. Select an option from the [Transmit Power](#) drop-down list: [High](#), [Middle](#) or [Low](#). The default and recommended setting is [High](#).

- **To change channel settings:**

1. Go to [Wireless > Wireless Settings](#).
2. Select a [Channel Width](#) (bandwidth) for the wireless network. It is recommended to just leave it as default.
3. Select an operating [Channel](#) for the wireless network. It is recommended to leave the channel to [Auto](#) if you are not experiencing the intermittent wireless connection issue.

- **To change the transmission mode:**

1. Go to [Wireless > Wireless Settings](#).
2. Disable [Smart Connect](#), then select a transmission [Mode](#) according to your wireless client devices. It is recommended to just leave it as default.

- **To Share Network:**

1. Go to [Wireless > Wireless Settings](#).
2. Click [Share Network](#) to share the SSID and password to your guests.

### 5.4.2. Guest Network

Guest Network allows you to provide Wi-Fi access for guests without disclosing your host network. When you have guests in your house, apartment, or workplace, you can

create a guest network for them. In addition, you can customize guest network settings to ensure network security and privacy.

- **Create a Network for Guests:**

1. Visit <http://tplinkwifi.net>, and log in with your TP-Link ID or the password you set for the router.
2. Go to [Wireless](#) > [Guest Network](#).
3. Create a guest network as needed.
  - 1) Tick the Enable checkbox for the 2.4GHz or 5 GHz wireless network.
  - 2) Customize the SSID. Don't select [Hide SSID](#) unless you want your guests to manually input the SSID for guest network access.
  - 3) Click [Share Network](#) to share the SSID and password to your guests.
  - 4) Set the [Effective Time](#) to keep the guest network on during the selected duration.
  - 5) Select the [Security](#) type and customize your own password. If [None](#) is selected, no password is needed to access your guest network.

The screenshot shows the 'Guest Network' configuration page. At the top, it says 'Create a separate network for your guests to ensure network security and privacy.' Below this, there are two sections for 2.4 GHz and 5 GHz networks. For each, there is an 'Enable' checkbox (checked), a 'Network Name (SSID)' text box (containing 'TP-Link\_Guest\_3B7A' and 'TP-Link\_Guest\_3B7A\_5G' respectively), a 'Hide SSID' checkbox (unchecked), and a 'Share Network' link. At the bottom, there is a 'Security' dropdown menu (set to 'None') with a warning message: 'This security type is not considered secure. Consider selecting the WPA2-PSK[AES] or WPA3 encryption.' and an 'Effective Time' dropdown menu (set to '4 Hours').

4. Click [SAVE](#). Now your guests can access your guest network using the SSID and password you set!

 **Tips:** To view guest network information, go to [Network Map](#) and locate the [Guest Network](#) section. You can turn on or off the guest network function conveniently.

- **Customize Guest Network Options:**

1. Visit <http://tplinkwifi.net>, and log in with your TP-Link ID or the password you set for the router.
2. Go to [Wireless](#) > [Guest Network](#). Locate the [Guest Permissions](#) section.
3. Customize guest network options according to your needs.

**Guest Permissions**

Control the data that guests can access.

---

Allow guests to see each other

- [Allow guests to see each other](#)

Tick this checkbox if you want to allow the wireless clients on your guest network to communicate with each other via methods such as network neighbors and Ping.

4. Click [SAVE](#). Now you can ensure network security and privacy!

### 5.4.3. IoT Network

This feature further secures your home network by allowing you to create a dedicated wireless network to manage your IoT devices together, such as smart lights and cameras.

1. Visit <http://tplinkwifi.net>, and log in with your TP-Link ID or the password you set for the router.
2. Go to [Wireless > IoT Network](#).
3. Create an IoT network as needed.
  - 1) Tick the Enable checkbox for the 2.4GHz or 5 GHz wireless network. For 5 GHz IoT networks, make sure your IoT devices can connect to a 5 GHz network.
  - 2) Customize the SSID. Don't select [Hide SSID](#) unless you want your IoT devices to manually input the SSID for network access.
  - 3) Click [Share Network](#) to share the SSID and password to others.
  - 4) Select the [Security](#) type and customize your own password. If [None](#) is selected, no password is needed to access the IoT network.

### IoT Network

Create a dedicated wireless network to manage your IoT devices together, such as smart lights and camera.

2.4 GHz:  Enable [Share Network](#)

Network Name (SSID):   Hide SSID

Security:

Password:

5 GHz:  Enable [Share Network](#)

Make sure your IoT devices can connect to a 5 GHz Network.

Network Name (SSID):   Hide SSID

Security:

Password:

4. Click [SAVE](#). Now you can connect your IoT devices to the dedicated IoT network.

#### 5. 4. 4. Wireless Schedule

You can schedule the wireless function of your router. The wireless network can be automatically off at a specific time when you do not need the wireless connection.

1. Visit <http://tplinkwifi.net>, and log in with your TP-Link ID or the password you set for the router.
2. Go to [Wireless](#) > [Wireless Schedule](#).

### Wireless Schedule

Schedule when to automatically turn off your wireless network.

Wireless Schedule:  Enable

**Note:** Make sure [Time Settings](#) are correct before using this function.

Current Time: 23/09/2024 01:29:33

[+ Add](#)

Wireless Off Time	Repeat	Modify
No Entries in this table.		

3. Tick the [Enable](#) checkbox to enable the wireless schedule function.
4. Click [Add](#) to specify a wireless off period during which you need the wireless off automatically, and click [SAVE](#).

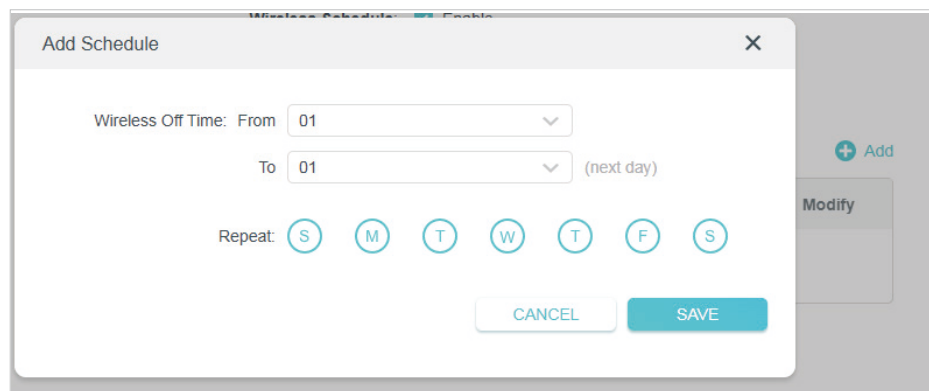

5. The wireless schedules added will appear in the list. You can modify the settings here.

Wireless Off Time	Repeat	Modify
23:00-7:00 (next day)	Mon, Tue, Wed, Thu, Fri, Sat	
20:00-21:00	Every Day	

**Note:**

- The Effective Time Schedule is based on the time of the router. You can go to Advanced > System > Time & Language to modify the time.
- The wireless network will be automatically turned on after the time period you set.

### 5.4.5. WPS

WPS (Wi-Fi Protected Setup) can help you to quickly and securely connect to a network. This section will guide you to add a new wireless device to your router's network quickly via WPS.

**Note:**

The WPS function cannot be configured if the wireless function of the router is disabled. Please make sure the wireless function is enabled before configuration.

1. Visit <http://tplinkwifi.net>, and log in with your TP-Link ID or the password you set for the router.
2. Go to **Wireless > WPS**.
3. Click to enable the WPS function.
4. Follow one of the following methods to connect your client device to the router's Wi-Fi network.

• **Connect via the Client's PIN**

1. Select **Client's PIN**.
2. Enter the PIN of your device and click **CONNECT**. Then your device will get connected to the router.

**WPS**

Use WPS (Wi-Fi Protected Setup) to connect a client (personal device) to the router's wireless network easily.

**WPS:**

**Method 1:** Using a PIN

Client's PIN

Router's PIN

Enter your personal device's PIN here and click **CONNECT**

**CONNECT**

### • Connect via the Router's PIN

1. Select [Router's PIN](#).
2. Enable [Router's PIN](#). You can click [GET NEW PIN](#) to generate a new one or click [DEFAULT](#) to use the default PIN.
3. Enter the router's PIN on your personal device.

**WPS:**

**Method 1:** Using a PIN

Client's PIN

Router's PIN

**Router's PIN:**

Enter the router's PIN on your personal device.  
Router's PIN: **12345670**

**GET NEW PIN**

**DEFAULT**

#### Note:

PIN (Personal Identification Number) is an eight-character identification number preset to each router. WPS supported devices can connect to your router with the PIN. The default PIN is printed on the label of the router.

### • Push the WPS Button

1. Click the [Start](#) button on the screen or directly press the router's WPS button. Within two minutes, press the WPS button on your client device.
2. A success message will appear on the page if the client device has been successfully added to the router's network. And the Wi-Fi LED of the router should change from flashing to solid on, indicating successful WPS connection.

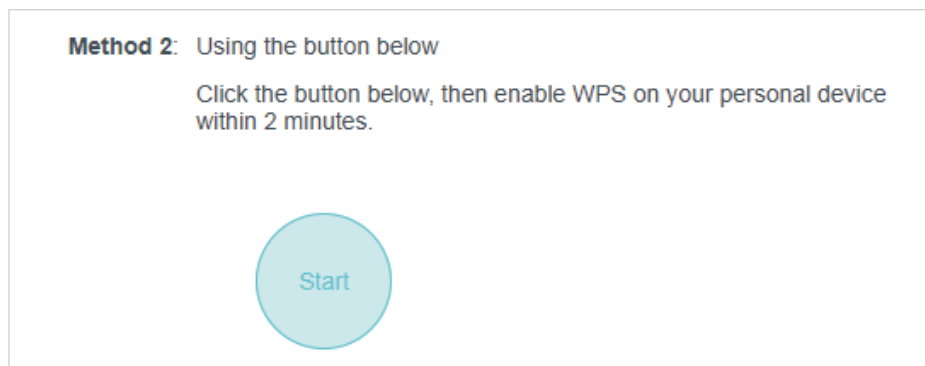

### 5. 4. 6. Advanced Wireless Settings

Check advanced wireless settings for your device.

1. Visit <http://tplinkwifi.net>, and log in with your TP-Link ID or the password you set for the router.
2. Go to [Wireless > Additional Settings](#).

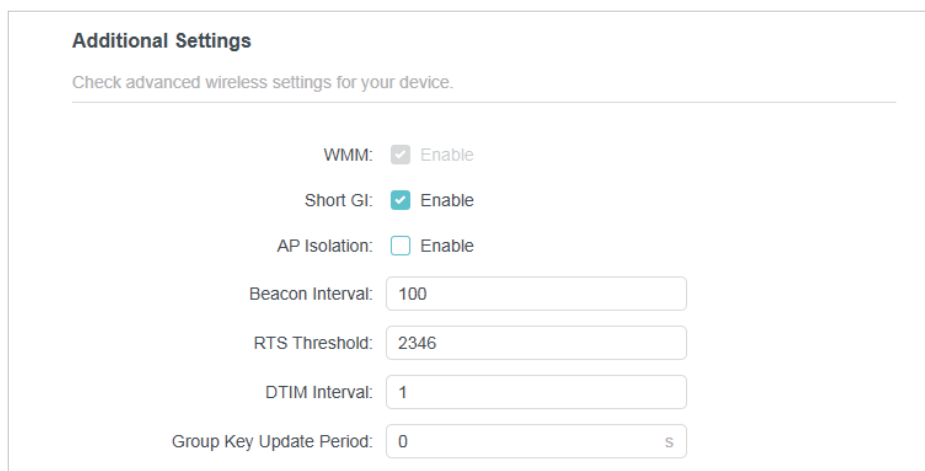

- **WMM** - WMM (Wi-Fi multimedia) function can guarantee the packets with high-priority messages being transmitted preferentially.
- **Short GI** - It is recommended to enable Short GI (Short Guard Interval) function, for it will increase the data capacity by reducing the guard interval time.
- **AP Isolation** - This function isolates all connected wireless stations so that wireless stations cannot access each other through WLAN.
- **Beacon Interval** - Enter a value between 40 and 1000 in milliseconds to determine the duration between beacon packets that are broadcasted by the router to synchronize the wireless network. The default value is 100 milliseconds.
- **RTS Threshold**- Enter a value between 1 and 2346 to determine the packet size of data transmission through the router. By default, the RTS (Request to Send) Threshold

size is 2346. If the packet size is greater than the preset threshold, the router will send RTS frames to a particular receiving station and negotiate the sending of a data frame.

- **DTIM Interval** - The value determines the interval of DTIM (Delivery Traffic Indication Message). Enter a value between 1 and 15 intervals. The default value is 1, which indicates the DTIM Interval is the same as Beacon Interval.
- **Group Key Update Period** - Enter a number of seconds (minimum 30) to control the time interval for the encryption key automatic renewal. The default value is 0, meaning no key renewal.

## 5.5. Manage the Router

### 5.5.1. Firmware Update

TP-Link aims at providing better network experience for users.

We will inform you through the web management page if there's any new firmware available for your router. Also, the latest firmware will be released at the TP-Link official website [www.tp-link.com](http://www.tp-link.com), and you can download it from the [Support](#) page for free.

**Note:**

- Back up your router's configurations before firmware update.
- Do NOT turn off the router during the firmware update.

• **Online Update:**

1. Visit <http://tplinkwifi.net>, and log in with your TP-Link ID or the password you set for the router.
2. Go to [Advanced](#) > [Firmware Update](#).
3. When the latest firmware is available for your router, the update icon  will display in the top-right corner of the page. Click the icon to go to the [Firmware Update](#) page.

Alternatively, you can go to [Advanced](#) > [System](#) > [Firmware Update](#), and click **CHECK FOR UPDATES** to see whether the latest firmware is released.



4. Focus on the [Online Update](#) section, and click **UPDATE** if there is new firmware.

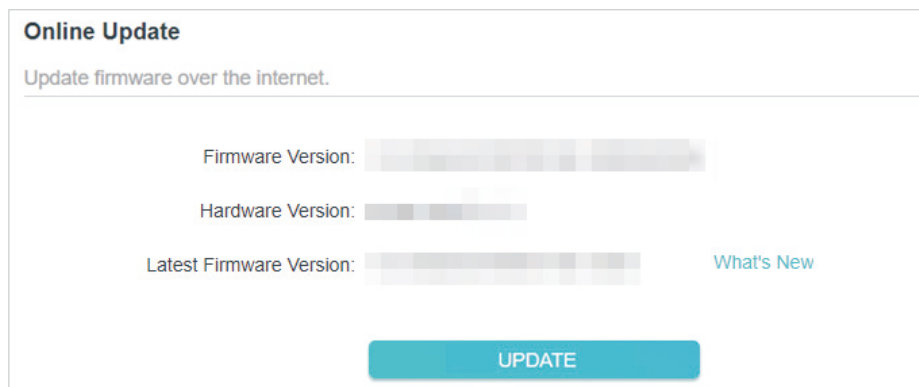

The screenshot shows the 'Online Update' section of the router's web management page. It features a title 'Online Update' and a subtitle 'Update firmware over the internet.' Below this, there are three rows of information: 'Firmware Version:' followed by a blurred text box, 'Hardware Version:' followed by a blurred text box, and 'Latest Firmware Version:' followed by a blurred text box. To the right of the 'Latest Firmware Version:' row is a link labeled 'What's New'. At the bottom center of the section is a large teal button labeled 'UPDATE'.

5. Wait a few minutes for the update and reboot to complete.

 **Tips:** If there's a new and important firmware update for your router, you will see the prompt notification on your computer as long as a web browser is opened. Click to update, and log in to the web management page with the username and password you set for the router. You will see the [Firmware Update](#) page.

- **Local Update:**

1. Download the latest firmware file for the router from [www.tp-link.com](http://www.tp-link.com).
2. Visit <http://tplinkwifi.net>, and log in with your TP-Link ID or the password you set for the router.
3. Go to [Advanced](#) > [Firmware Update](#).
4. Focus on the [Local Update](#) section. Click [BROWSE](#) to locate the downloaded new firmware file, and click [UPDATE](#).

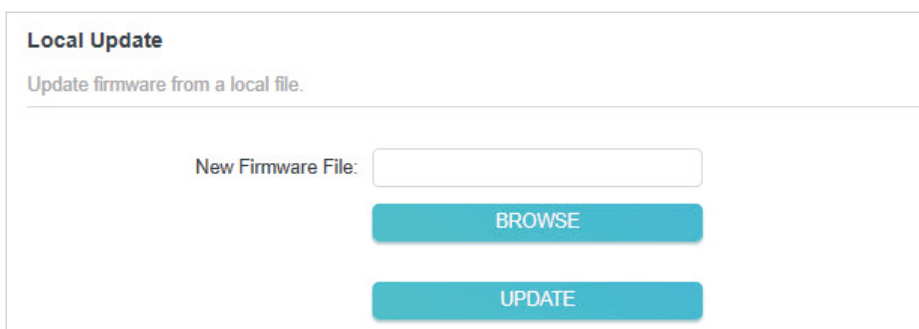

The screenshot shows the 'Local Update' section of the router's web management page. It features a title 'Local Update' and a subtitle 'Update firmware from a local file.' Below this, there is a label 'New Firmware File:' followed by a text input field. Underneath the input field are two teal buttons: 'BROWSE' and 'UPDATE'.

5. Wait a few minutes for the update and reboot to complete.

 **Note:** If you fail to update the firmware for the router, please contact our [Technical Support](#).

## 5.5.2. Backup and Restore Configuration Settings

The configuration settings are stored as a configuration file in the router. You can backup the configuration file to your computer for future use and restore the router to a previous settings from the backup file when needed. Moreover, if necessary you can erase the current settings and reset the router to the default factory settings.

1. Visit <http://tplinkwifi.net>, and log in with your TP-Link ID or the password you set for the router.

2. Go to [Advanced](#) > [Backup & Restore](#).

- **To backup configuration settings:**

Click [BACK UP](#) to save a copy of the current settings to your local computer. A '.bin' file of the current settings will be stored to your computer.

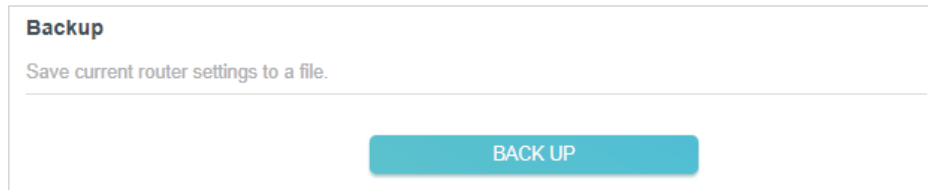

The screenshot shows a web interface titled "Backup". Below the title is the instruction "Save current router settings to a file." At the bottom of the panel is a large teal button labeled "BACK UP".

- **To restore configuration settings:**

1. Click [BROWSE](#) to locate the backup configuration file stored on your computer, and click [RESTORE](#).

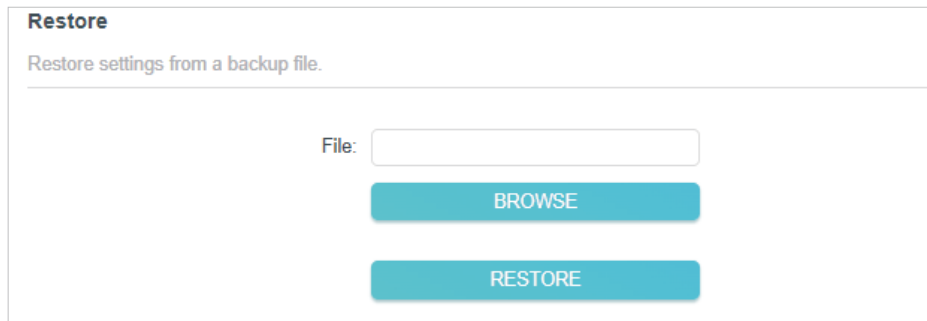

The screenshot shows a web interface titled "Restore". Below the title is the instruction "Restore settings from a backup file." There is a text input field labeled "File:" with a teal "BROWSE" button below it. Below the "BROWSE" button is a teal "RESTORE" button.

2. Wait a few minutes for the restoring and rebooting.

 **Note:** During the restoring process, do not turn off or reset the router.

- **To reset the router except your login password and TP-Link ID:**

1. In the [Factory Default Restore](#) section, click [RESTORE](#).

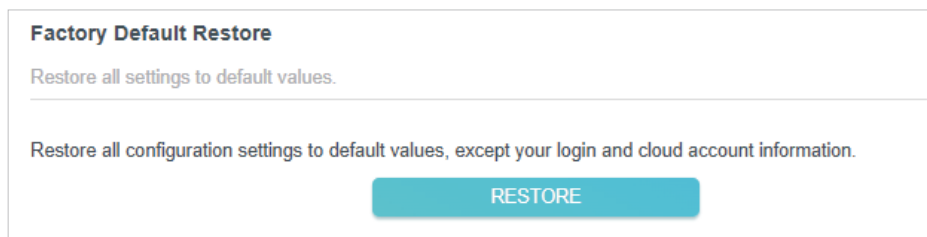

The screenshot shows a web interface titled "Factory Default Restore". Below the title is the instruction "Restore all settings to default values." Below this is a sub-instruction: "Restore all configuration settings to default values, except your login and cloud account information." At the bottom of the panel is a large teal button labeled "RESTORE".

2. Wait a few minutes for the resetting and rebooting.

 **Note:**

- During the resetting process, do not turn off the router.
- After reset, you can still use the current login password or the TP-Link ID to log in to the web management page.

- **To reset the router to factory default settings:**

1. Click [FACTORY RESTORE](#) to reset the router.

Restore all the configuration settings to their default values.

FACTORY RESTORE

2. Wait a few minutes for the resetting and rebooting.

**Note:**

- During the resetting process, do not turn off or reset the router.
- We strongly recommend you backup the current configuration settings before resetting the router.

### 5.5.3. Change Password

You can change your login password of the web management page.

**Note:** If you are using a TP-Link ID to log in to the web management page, the account management feature will be disabled. To manage the TP-Link ID, go to [Advanced > TP-Link ID](#).

1. Visit <http://tplinkwifi.net>, and log in with the password you set for the router.
2. Go to [Advanced > Administration](#) and focus on the [Change Password](#) section.

#### Change Password

Change the router's local management password.

Old Password:

New Password:

Confirm New Password:

3. Enter the old password, then a new password twice (both case-sensitive). Click [SAVE](#).
4. Use the new password for future logins.

### 5.5.4. Local Management

This feature allows you to limit the number of client devices on your LAN from accessing the router by using the MAC address-based authentication.

1. Visit <http://tplinkwifi.net>, and log in with your TP-Link ID or the password you set for the router.
2. Go to [Advanced > Administration](#) and complete the settings in [Local Management](#) section as needed.

• **Local Management via HTTPS:**

Tick the [Local Management via HTTPS](#) checkbox to access the router via HTTPS and HTTP, or keep it disabled to access the router only via HTTP. Click [SAVE](#).

**Local Management**

Access and manage the router from local network devices.

---

Local Management via HTTPS:  Enable

- Allow all LAN connected devices to manage the router:

Select [All Devices](#) for [Local Managers](#). Click [SAVE](#).

**Local Management**

Access and manage the router from local network devices.

---

Local Management via HTTPS:  Enable

Local Managers:

- Allow specific devices to manage the router:

1. Select [Specified Devices](#) for [Local Managers](#).

**Local Management**

Access and manage the router from local network devices.

---

Local Management via HTTPS:  Enable

Local Managers:

[+ Add Device](#)

Description	MAC Address	Operation
18101958-BG	B0-19-21-AA-B2-58	

2. Click [Add Device](#).

**Add Device** ✕

Description:

[VIEW CONNECTED DEVICES](#)

MAC Address:

[CANCEL](#) [SAVE](#)

3. Click [VIEW CONNECTED DEVICES](#) and select the device to manage the router from the Connected Devices list, or enter the MAC address of the device manually. Click [SAVE](#). The devices added will appear in the list.

4. Click **SAVE**.

### 5.5.5. HTTP Referer Head Check

HTTP referer header check function can protect your networks against CSRF attacks.

1. Visit <http://tplinkwifi.net>, and log in with your TP-Link ID or the password you set for the router.
2. Go to **Advanced > Administration**, and locate the HTTP Referer Head Check section.
3. HTTP Referer Head Check is enabled by default, and it is recommended to keep the default settings. This feature protects your network against cross-site request forgery (CSRF) attacks.

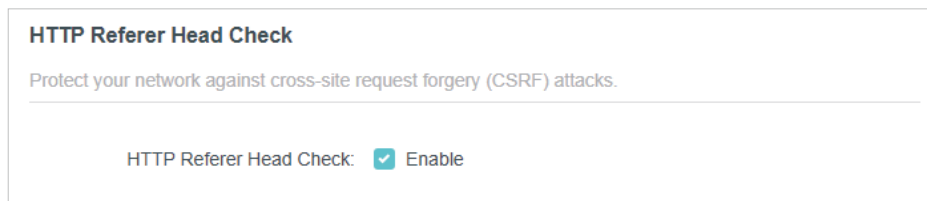

### 5.5.6. System Log

When the router does not work normally, you can save the system log and send it to the technical support for troubleshooting.

- **To save the system log locally:**

1. Visit <http://tplinkwifi.net>, and log in your TP-Link ID or the password you set for the router.
2. Go to **Advanced > System Log**.
3. In the **Save Log** section, click **SAVE TO LOCAL** to save the system logs to a local disk.

### System Log

View a detailed record of system activities.

---

Current Time: 23/09/2024 02:58:49

Refresh
Clear All

```

1 INFO 0days, 00:00:05, [tmpd]register tmp app, type: 1
2 INFO 0days, 00:00:05, [portal]portal init
3 INFO 0days, 00:00:05, [lan]LAN: Set interface br-lan0 ip=192.168.1.1 netmask 255.255.255.0.
4 INFO 0days, 00:00:05, [tmpd]register tmp app, type: 2
5 INFO 0days, 00:00:06, [tmpd]register tmp app, type: 4
6 INFO 0days, 00:00:12, [DSLite]Dslite disable
7 INFO 0days, 00:00:12, [portal]portal not enabled
8 INFO 0days, 00:00:12, [portal]portal stop
9 INFO 0days, 00:00:12, [httpd]Http server start!
10 INFO 0days, 00:00:14, [wan]Wan ethernet port plug on.
11 INFO 0days, 00:00:14, [dhcpc]Send DISCOVER with unicast flag 0
12 INFO 0days, 00:00:15, [dhcps]Send OFFER with ip 192.168.1.220.

```

### Save Log

Save system log locally.

SAVE TO LOCAL

### 5.5.7. Diagnostics

Diagnostics is used to test the connectivity between the router and the host or other network devices.

1. Visit <http://tplinkwifi.net>, and log in with your TP-Link ID or the password you set for the router.
2. Go to [Advanced](#) > [Diagnostics](#).

### Diagnostics

Troubleshoot network connectivity problems.

---

Diagnostic Tools:

IP Address/Domain Name:

● This field is required.

Ping Packet Number:

Ping Packet Size:  Bytes

START

3. Enter the information:

- 1) Choose [Ping](#) or [Traceroute](#) as the diagnostic tool to test the connectivity;

- **Ping** is used to test the connectivity between the router and the tested host, and measure the round-trip time.
  - **Traceroute** is used to display the route (path) your router has passed to reach the tested host, and measure transit delays of packets across an Internet Protocol network.
- 2) Enter the **IP Address** or **Domain Name** of the tested host.
  - 3) Modify the **Ping Packet Number** and the **Ping Packet Size**. It's recommended to keep the default value.
  - 4) If you have chosen **Traceroute**, you can modify the **Traceroute Max TTL**. It's recommended to keep the default value.

4. Click **START** to begin the diagnostics.

The figure below indicates the proper connection between the router and the Yahoo server (www.Yahoo.com) tested through **Ping**.

```
Finding host www.yahoo.com by DNS server (1 of 2).
Pinging www.yahoo.com [69.147.80.15] with 64 bytes of data:
Reply from 69.147.80.15: bytes=64 time=233ms TTL=47 (seq=0).
Reply from 69.147.80.15: bytes=64 time=450ms TTL=47 (seq=1).
Reply from 69.147.80.15: bytes=64 time=383ms TTL=47 (seq=2).
Reply from 69.147.80.15: bytes=64 time=250ms TTL=47 (seq=3).
Ping statistics for 69.147.80.15:
Packets: Sent = 4, Received = 4, Lost = 0 (0% loss).
Approximate round trip times in milli-seconds:
Minimum = 233ms, Maximum = 450ms, Average = 329ms
```

The figure below indicates the proper connection between the router and the Yahoo server (www.Yahoo.com) tested through **Traceroute**.

```
Finding host www.yahoo.com by DNS server (1 of 2).
Tracing route to www.yahoo.com [69.147.80.12]
over a maximum of 30 hops:
 0 33 ms 16 ms 16 ms 192.168.194.221
 1 * * * Request timed out.
 2 * * * Request timed out.
 3 100 ms 100 ms 100 ms 172.21.1.1
 4 83 ms 100 ms 100 ms 172.21.5.49
 5 * * 66 ms 172.21.5.9
 6 * 100 ms * 183.233.80.105
 7 * * 66 ms 221.183.53.97
 8 183 ms 83 ms 116 ms 221.183.167.30
 9 150 ms 150 ms 83 ms 221.183.92.214
```

### 5. 5. 8. Set System Time and Language

System time is the time displayed while the router is running. The system time you configure here will be used for other time-based functions like Parental Controls. You can choose the way to obtain the system time as needed.

System language is the language displayed when you log into the router. You can change the system language as needed.

1. Visit <http://tplinkwifi.net>, and log in with your TP-Link ID or the password you set for the router.
2. Go to [Advanced > Time & Language](#).
  - **To get time from the internet:**
    1. Enable [24-Hour Time](#) if you want the time to display in a 24-hour way.
    2. In the [Set Time](#) field, select [Get from Internet](#).

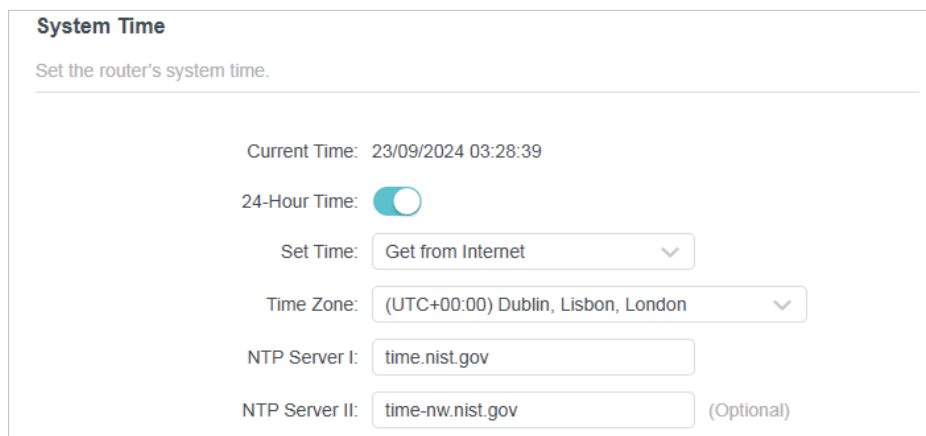

**System Time**  
Set the router's system time.

Current Time: 23/09/2024 03:28:39

24-Hour Time:

Set Time: [Get from Internet](#)

Time Zone: [\(UTC+00:00\) Dublin, Lisbon, London](#)

NTP Server I: [time.nist.gov](#)

NTP Server II: [time-nw.nist.gov](#) (Optional)

3. Select your local [Time Zone](#) from the drop-down list.
4. In the [NTP Server I](#) field, enter the IP address or domain name of your desired NTP Server.
5. (Optional) In the [NTP Server II](#) field, enter the IP address or domain name of the second NTP Server.
6. Click [SAVE](#).

- **To get time from your computer:**

1. In the [Set Time](#) field, select [Get from Managing Device](#).

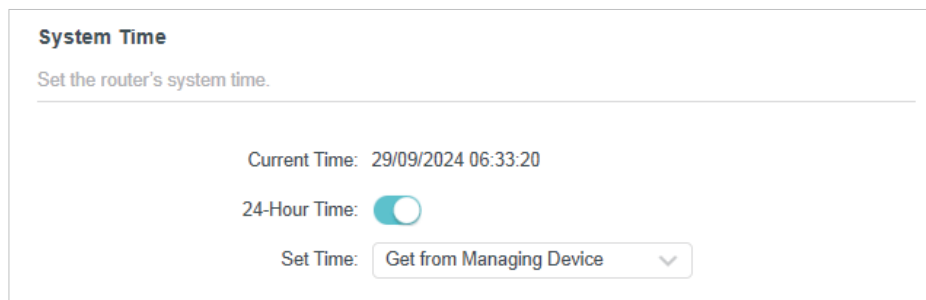

**System Time**  
Set the router's system time.

Current Time: 29/09/2024 06:33:20

24-Hour Time:

Set Time: [Get from Managing Device](#)

2. The time of your computer will then be displayed and click [SAVE](#).

- **To manually set the date and time:**

1. In the **Set Time** field, select **Manually**.

### System Time

Set the router's system time.

Current Time: 29/09/2024 06:34:16

24-Hour Time:

Set Time:

Date:

Time:  :  :

2. Set the current **Date** (In **DD/MM/YYYY** format).
3. Set the current **Time** (In **HH/MM/SS** format).
4. Click **SAVE**.

- **To set Daylight Saving Time:**

1. Tick the **Enable** box of **Daylight Saving Time**.

### Daylight Saving Time

Automatically synchronize the system time with daylight saving time.

Daylight Saving Time:  Enable

Start: 2024

End: 2024

Running Status: Daylight Saving Time is off.

2. Select the correct **Start** date and time when daylight saving time starts at your local time zone.
3. Select the correct **End** date and time when daylight saving time ends at your local time zone.
4. Click **SAVE**.

- **To set system language:**

Select the language from the dropdown list, then click **SAVE**.

### Language

Set the router's system language.

---

Language:

## 5.5.9. Reboot & Reboot Schedule

- **To reboot the router:**

You can reboot the router to clear cache and enhance running performance.

1. Visit <http://tplinkwifi.net>, and log in with your TP-Link ID or the password you set for the router.
2. Go to [Advanced > Reboot](#).
3. Click **REBOOT**.

### Reboot

Reboot to clear cache and enhance running performance.

---

**REBOOT**

- **To set reboot schedule:**

The Scheduled Reboot feature cleans the cache to enhance the running performance of the router.

1. Visit <http://tplinkwifi.net>, and log in with your TP-Link ID or the password you set for the router.
2. Go to [Advanced > Reboot](#).
3. Tick the **Enable** box of **Reboot Schedule**.

### Reboot Schedule

Set when and how often the router reboots automatically.

---

**Reboot Schedule:**  Enable

**Note:** Make sure [Time Settings](#) are correct before using this function.

**Current Time:** 23/09/2024 03:34:40

Reboot Time:  :

Repeat:

- Specify the [Reboot Time](#) when the router reboots and [Repeat](#) to decide how often it reboots.
- Click [SAVE](#).

### 5.5.10. Control the LED

- To turn off or turn on the LEDs:**

You can turn the router's LEDs on or off.

- Visit <http://tplinkwifi.net>, and log in with your TP-Link ID or the password you set for the router.
- Go to [Advanced](#) > [LED Control](#).
- Toggle the [LED Status](#) button to turn on or turn off the LEDs.

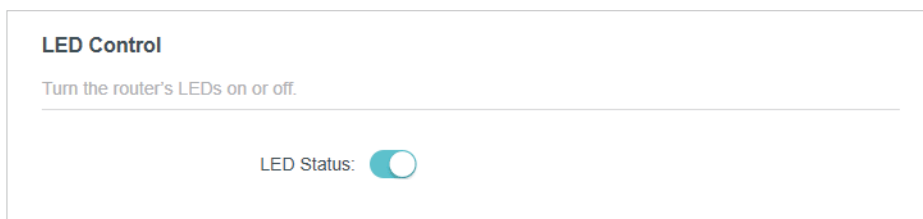

- To enable Night Mode for the LEDs:**

The LED of the router indicates its activities and status. You can enable the Night Mode feature to specify a time period during which the LED is off.

- Visit <http://tplinkwifi.net>, and log in with your TP-Link ID or the password you set for the router.
- Go to [Advanced](#) > [LED Control](#).
- Enable [Night Mode](#).
- Specify the LED off time, and the LED will be off during this period every day.
- Click [SAVE](#).

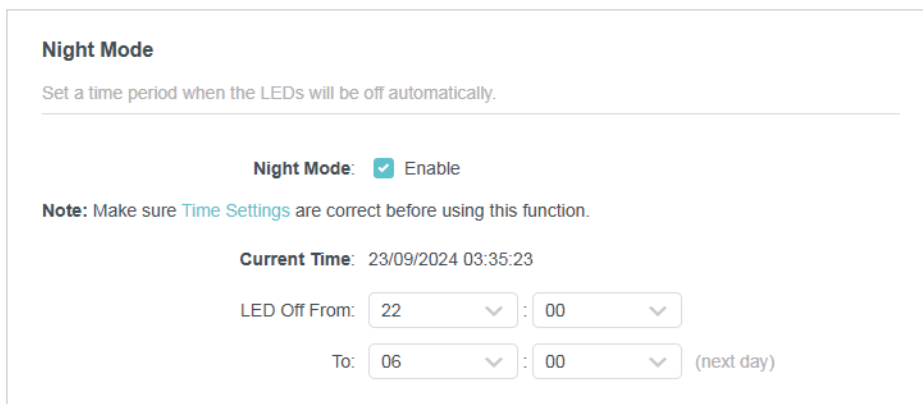

## Chapter 6

---

# Configure the Router in Range Extender Mode

---

This chapter presents how to configure the various features of the router working as a wireless router.

It contains the following sections:

- [Network Map](#)
- [Operation Mode](#)
- [Network](#)
- [Wireless Settings](#)
- [Manage the Router](#)

## 6.1. Network Map

Network Map outlines device connectivity of your network visually and helps you manage general settings of the network.

1. Visit <http://tplinkwifi.net>, and log in with your TP-Link ID or the password you set for the router.
2. Go to [Network Map](#).
3. Click each network device icon to check and manage general network settings.
  - Click [Internet](#) to check internet status.

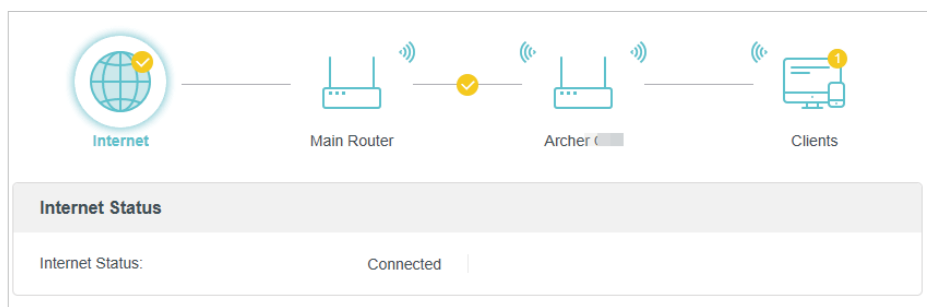

- Click [Main Router](#) to check the connection status to the main network. You can connect or disconnect to the main network, or click [Edit](#) to change related settings.

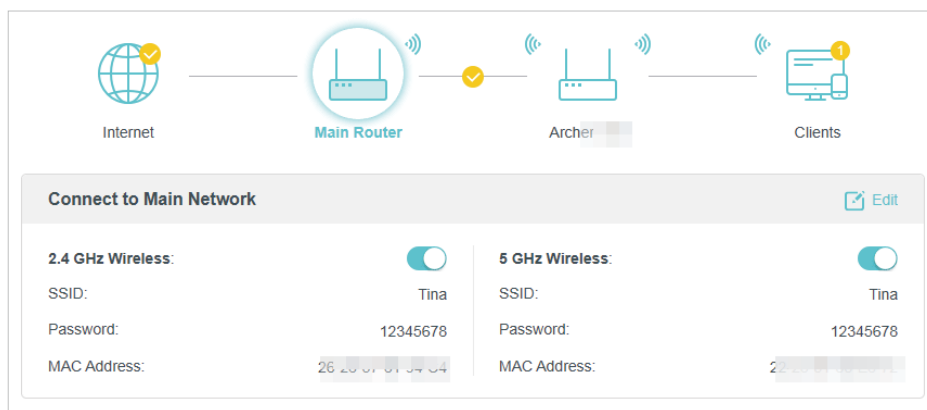

- Click the router to check device status and network settings. You can turn on or off the extended network, or click [Edit](#) to change related settings.

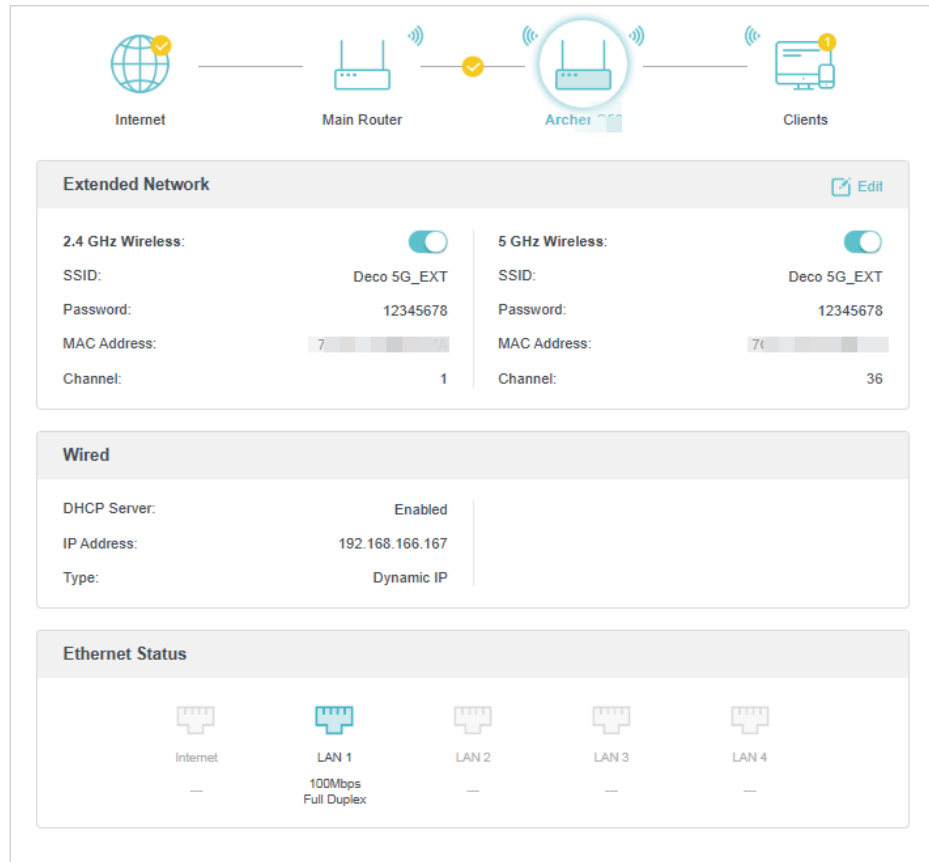

- Click [Clients](#) to view the client devices in your network. You can block devices so they cannot access your network.

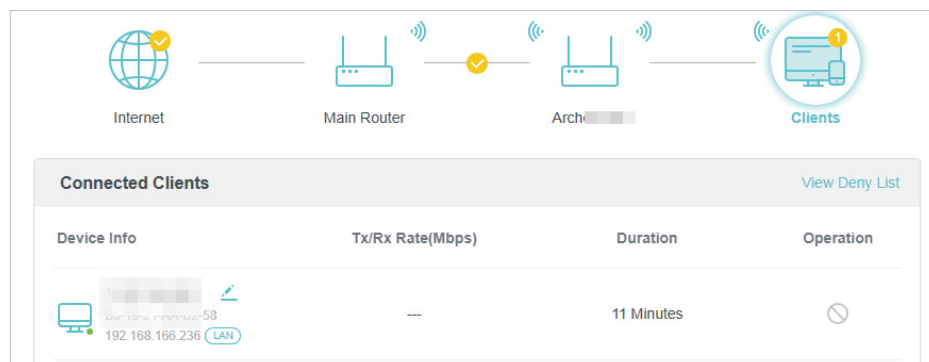

## 6.2. Operation Mode

1. Visit <http://tplinkwifi.net>, and log in with the password you set for the router.
2. Go to [Advanced](#) > [Operation Mode](#).
3. Select the working mode as needed and click [SAVE](#).

**Operation Mode**

Select an operation mode according to your needs.

Router Mode

In this mode, the router can provide internet access for multiple wired and wireless devices. This mode is required most commonly.



Access Point Mode

In this mode, the router changes an existing wired network into a wireless one.

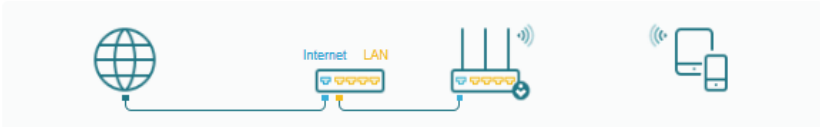

Range Extender Mode (Current)

In this mode, the router boosts the existing wireless coverage in your home.



## 6.3. Network

This chapter guides you on how to configure advanced network features.

### 6.3.1. LAN Settings

The router is preset with a default LAN IP, which you can use to log in to its web management page. The LAN IP address together with the Subnet Mask also defines the subnet that the connected devices are on. If the IP address conflicts with another device on your local network or your network requires a specific IP subnet, you can change it.

1. Visit <http://tplinkwifi.net>, and log in with your TP-Link ID or the password you set for the router.
2. Go to **Internet > LAN**.
3. Configure the IP parameters of the LAN and click **SAVE**.

**LAN**

View and configure LAN settings.

---

MAC Address: D8-44-89-E8-30-80

IP Type:  Dynamic IP  
 Static IP

IP Address:

Subnet Mask:  ▼

Default Gateway:

- **MAC Address** - The physical address of the LAN ports. The value can not be changed.
- **IP Type** - Either select **Dynamic IP** to get IP address from DHCP server, or **Static IP** to configure IP address manually.
- **IP Address** - Enter the IP address in dotted-decimal notation if your select Static IP.
- **Subnet Mask** - An address code that determines the size of the network.
- **Default Gateway** - The Gateway currently used is shown here. Enter the Default Gateway in dotted-decimal notation if your select Static IP.

**Note:**

- If you have changed the IP address, you must use the new IP address to login.
- If you select **Dynamic IP**, the DHCP server of the router will not start up.
- If the new IP address you set is not in the same subnet as the old one, the IP Address pool in the DHCP Server will be configured.

### 6.3.2. DHCP Server Settings

When enabled, the DHCP server dynamically assigns TCP/IP parameters to client devices from the IP Address Pool. You can change the settings of the DHCP Server if necessary, and you can reserve LAN IP addresses for specified client devices.

1. Visit <http://tplinkwifi.net>, and log in with your TP-Link ID or the password you set for the router.
2. Go to **Internet > DHCP Server**.

- **To specify the IP address that the router assigns:**

**DHCP Server:**  Enable

IP Address Pool: 192.168.68.100 - 192.168.68.199

Address Lease Time: 1 minutes

Default Gateway: 192.168.68.1 (Optional)

Primary DNS: 0.0.0.0 (Optional)

Secondary DNS: 0.0.0.0 (Optional)

1. Tick the [Enable](#) checkbox.
2. Enter the starting and ending IP addresses in the [IP Address Pool](#).
3. Enter the [Address Lease Time](#). It is the amount of time a network user will be allowed to connect to the router with the current dynamic IP Address. When time is up, the user will be automatically assigned a new dynamic IP address. The range of the time is 1 ~ 2880 minutes.
4. Set the [Default Gateway \(Optional\)](#). It is suggested to input the IP address of the LAN port of the router.
5. Set the [DNS Server \(Optional\)](#). Input the DNS IP address provided by your ISP.
6. Set the [Secondary DNS Server \(Optional\)](#). Input the IP address of another DNS server if your ISP provides two DNS servers.
7. Click [SAVE](#).

- **To reserve an IP address for a specified client device:**

1. Click [Add](#) in the [Address Reservation](#) section.

**Address Reservation**

Reserve IP addresses for specific devices connected to the router.

[+ Add](#)

Device Name	MAC Address	Reserved IP Address	Status	Modify
No Entries in this table.				

2. Click [VIEW CONNECTED DEVICES](#) and select the you device you want to reserve an IP for. Then the [MAC Address](#) will be automatically filled in. Or enter the [MAC address](#) of the client device manually.

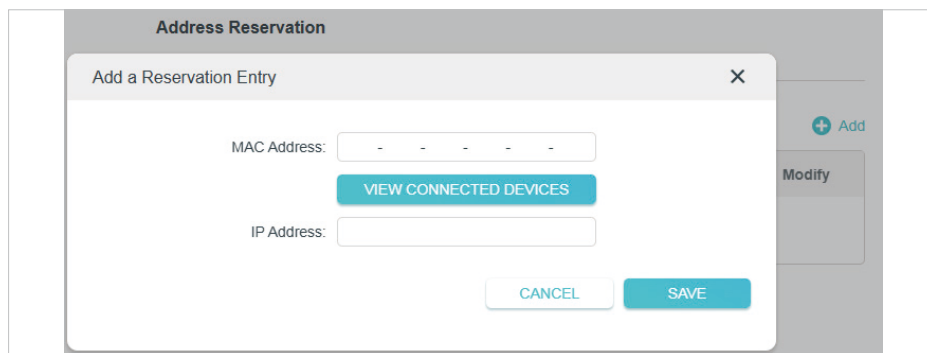

3. Enter the [IP address](#) to reserve for the client device.

4. Click [SAVE](#).

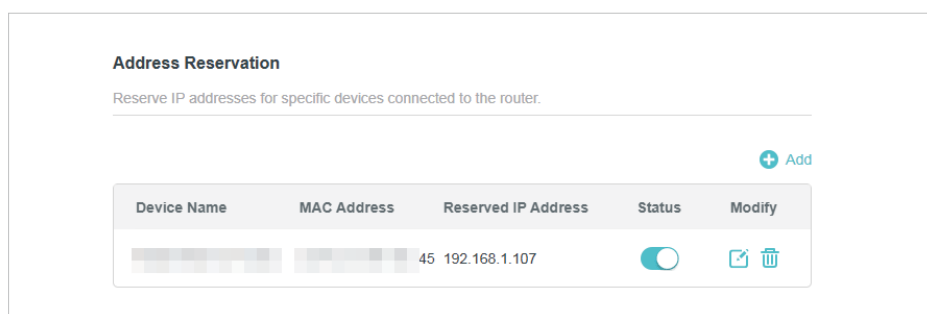

- **To view devices assigned with IP addresses by the DHCP server:**

You can view the devices that are currently assigned with IP addresses by the DHCP server in [DHCP Client List](#).

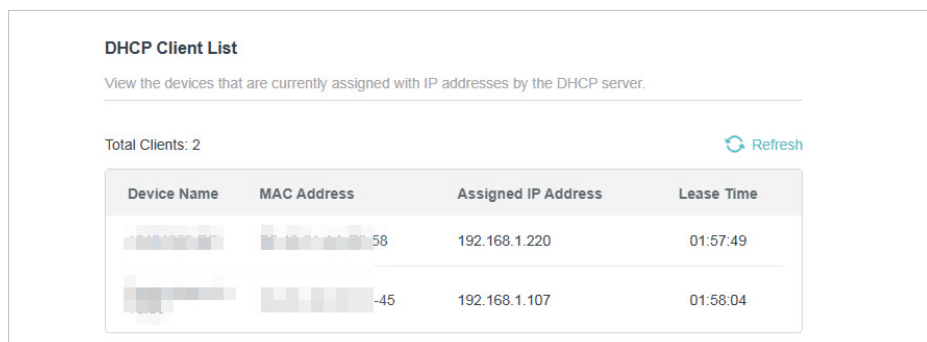

### 6.3.3. Access Control

In Access Point mode, the Access Control feature is used to block specific client devices to access your network (via wired or wireless) based on a list of blocked devices (Decy List).

#### I want to:

Block specific client devices to access my network (via wired or wireless).

## How can I do that?

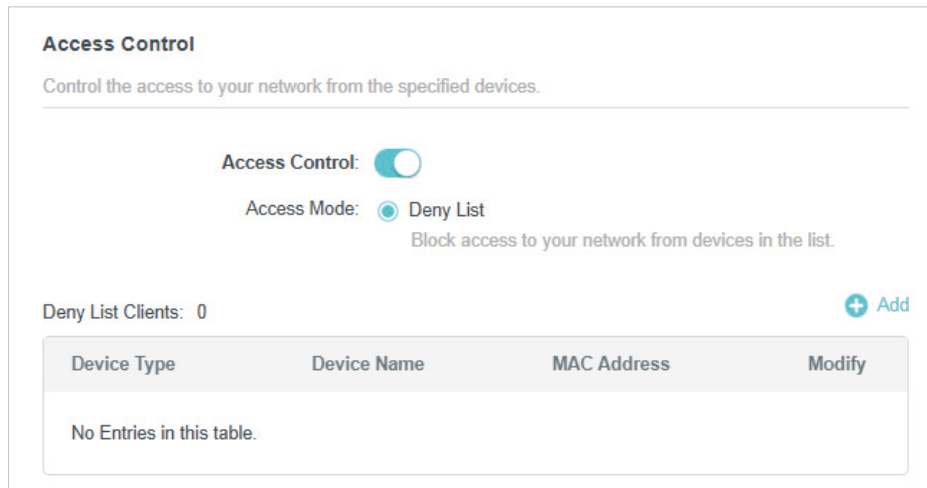

1. Visit <http://tplinkwifi.net>, and log in with your TP-Link ID or the password you set for the router.
2. Go to [Internet > Access Control](#).
3. Toggle on to enable [Access Control](#).

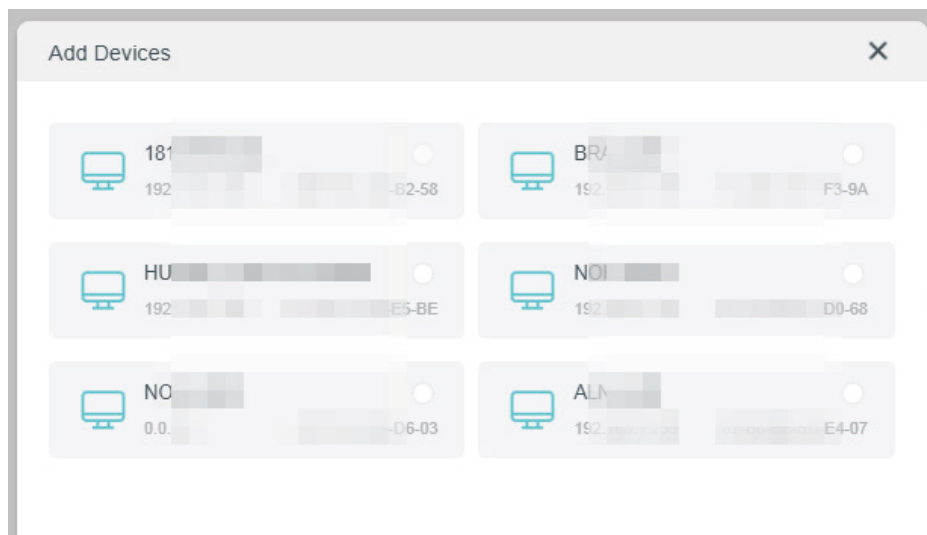

4. Click [+ Add](#) and select devices you want to block. Then click [ADD](#).



5. The Operation Succeeded message will appear on the screen, which means the selected devices have been successfully added to the Deny List.

Deny List Clients: 1 <span style="float: right;">+ Add</span>			
Device Type	Device Name	MAC Address	Modify
	[REDACTED]	[REDACTED]5	

## Done!

Now you can block specific client devices to access your network (via wired or wireless) using the [Deny List](#).

## 6.4. Wireless Settings

This chapter guides you on how to configure the wireless settings.

### 6.4.1. Connect to the Main Network

You can connect the device to an existing Wi-Fi to expand Wi-Fi coverage.

1. Visit <http://tplinkwifi.net>, and log in with your TP-Link ID or the password you set for the router.
2. Go to [Wireless](#) and locate the [Connect to the Network](#) section.

**Connect to the Network**

Connect the device to an existing Wi-Fi to expand Wi-Fi coverage.

---

2.4 GHz:  Enable

[Wi-Fi SCANNER](#)

SSID:

MAC Address:

Lock to AP

Security:

Password:

5 GHz:  Enable

[Wi-Fi SCANNER](#)

SSID:

MAC Address:

Lock to AP

Security:

Password:

3. Click **Wi-Fi SCANNER** and select a main network to connect to.

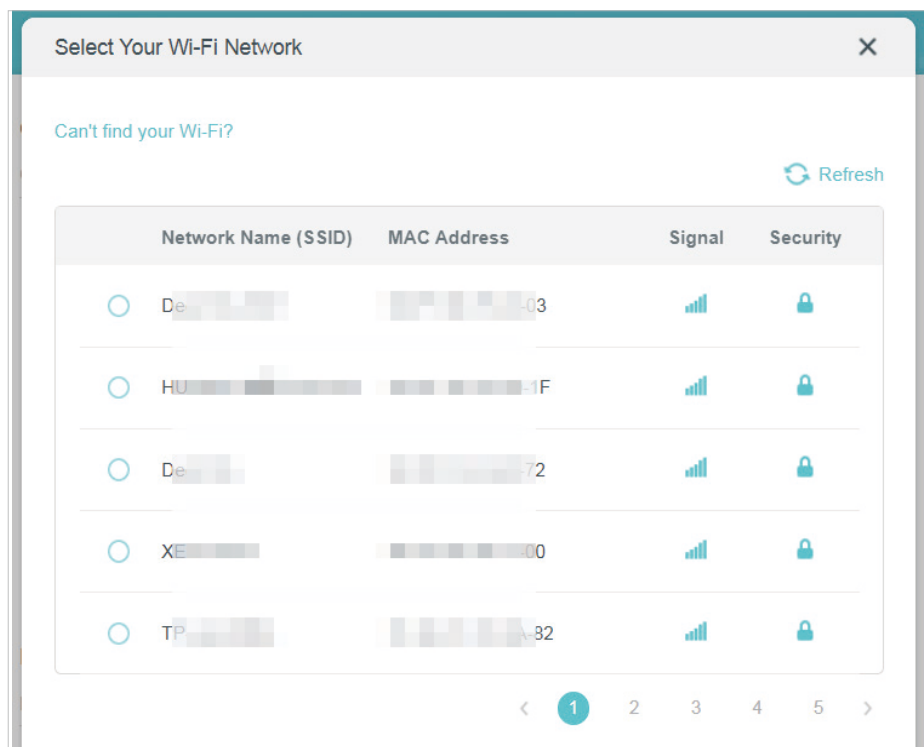

4. Enter the **Password** of the main network.
5. Tick the **Lock to AP** checkbox to stick to one wireless access point all the time even though there is another access point having the same wireless settings.
6. Click **SAVE**.

#### 6. 4. 2. Specify Wireless Settings

You can personalize wireless settings as you need.

1. Visit <http://tplinkwifi.net>, and log in with your TP-Link ID or the password you set for the router.
2. Go to **Wireless** and locate the **Extended Network** section.

**Extended Network**

Personalize settings for your extended network.

---

2.4 GHz:  Enable Share Network

Extended SSID:   Hide SSID

**COPY MAIN NETWORK SSID**

Security:  ▼

Password:

5 GHz:  Enable Share Network

Extended SSID:   Hide SSID

[COPY MAIN NETWORK SSID](#)

Security:  ▼

Password:

- **To enable or disable the wireless function:**

1. Go to [Wireless](#) and locate the [Extended Network](#) section.
2. The wireless bands are enabled by default. If you want to disable a wireless band, just deselect its [Enable](#) checkbox.

- **To change the wireless network name (SSID) and wireless password:**

1. Go to [Wireless](#) and locate the [Extended Network](#) section.
2. Create a new SSID in [Network Name \(SSID\)](#) or click [COPY MAIN NETWORK SSID](#) to copy the SSID of the main network. Customize the password for the network in [Password](#). The value is case-sensitive.

 **Note:** If you change the wireless settings with a wireless device, you will be disconnected when the settings are effective. Please write down the new SSID and password for future use.

- **To hide SSID:**

1. Go to [Wireless](#) and locate the [Extended Network](#) section.
2. Select [Hide SSID](#), and your SSID won't display when you scan for local wireless networks on your wireless device and you need to manually join the network.

- **To change the security option:**

1. Go to [Wireless](#) and locate the [Extended Network](#) section.
2. Select an option from the [Security](#) drop-down list. We recommend you don't change the default settings unless necessary.

## 6. 5. Manage the Router

### 6. 5. 1. Firmware Update

TP-Link aims at providing better network experience for users.

We will inform you through the web management page if there's any new firmware available for your router. Also, the latest firmware will be released at the TP-Link official website [www.tp-link.com](http://www.tp-link.com), and you can download it from the [Support](#) page for free.

📌 **Note:**

- Back up your router's configurations before firmware update.
- Do NOT turn off the router during the firmware update.

• **Online Update:**

1. Visit <http://tplinkwifi.net>, and log in with your TP-Link ID or the password you set for the router.
2. Go to [Advanced > Firmware Update](#).
3. When the latest firmware is available for your router, the update icon  will display in the top-right corner of the page. Click the icon to go to the [Firmware Update](#) page. Alternatively, you can go to [Advanced > Firmware Update](#), and click [CHECK FOR UPDATES](#) to see whether the latest firmware is released.

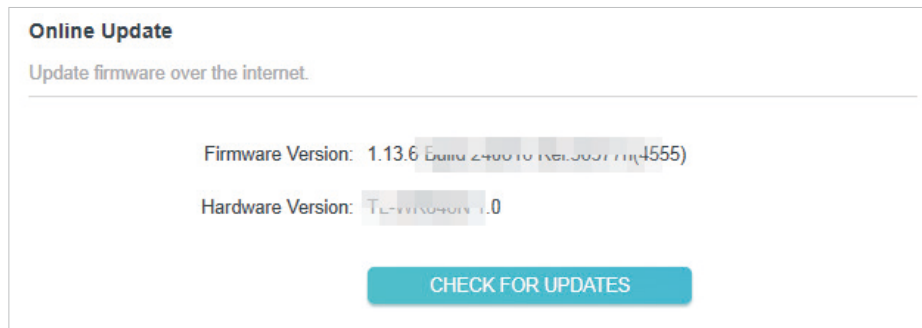

4. Focus on the [Online Update](#) section, and click [UPDATE](#) if there is new firmware.

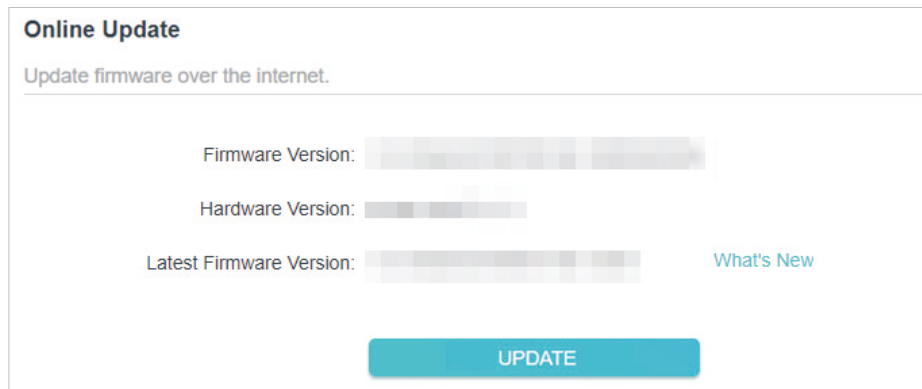

5. Wait a few minutes for the update and reboot to complete.

📌 **Tips:** If there's a new and important firmware update for your router, you will see the prompt notification on your computer as long as a web browser is opened. Click to update, and log in to the web management page with the username and password you set for the router. You will see the [Firmware Update](#) page.

• **Local Update:**

1. Download the latest firmware file for the router from [www.tp-link.com](http://www.tp-link.com).
2. Visit <http://tplinkwifi.net>, and log in with your TP-Link ID or the password you set for the router.

3. Go to [Advanced > Firmware Update](#).
4. Focus on the [Local Update](#) section. Click [BROWSE](#) to locate the downloaded new firmware file, and click [UPDATE](#).

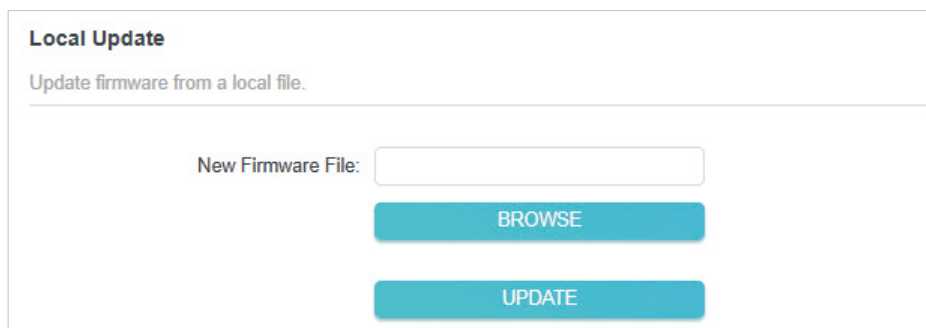

**Local Update**  
Update firmware from a local file.

New Firmware File:

[BROWSE](#)

[UPDATE](#)

5. Wait a few minutes for the update and reboot to complete.

 **Note:** If you fail to update the firmware for the router, please contact our [Technical Support](#).

## 6.5.2. Backup and Restore Configuration Settings

The configuration settings are stored as a configuration file in the router. You can backup the configuration file to your computer for future use and restore the router to a previous settings from the backup file when needed. Moreover, if necessary you can erase the current settings and reset the router to the default factory settings.

1. Visit <http://tplinkwifi.net>, and log in with your TP-Link ID or the password you set for the router.
2. Go to [Advanced > Backup & Restore](#).

- **To backup configuration settings:**

Click [BACK UP](#) to save a copy of the current settings to your local computer. A '.bin' file of the current settings will be stored to your computer.

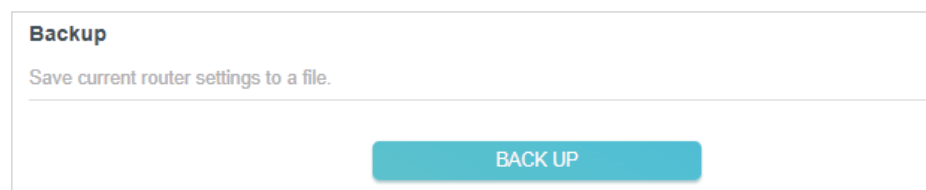

**Backup**  
Save current router settings to a file.

[BACK UP](#)

- **To restore configuration settings:**

1. Click [BROWSE](#) to locate the backup configuration file stored on your computer, and click [RESTORE](#).

**Restore**

Restore settings from a backup file.

---

File:

[BROWSE](#)

[RESTORE](#)

2. Wait a few minutes for the restoring and rebooting.

 **Note:** During the restoring process, do not turn off or reset the router.

- **To reset the router except your login password and TP-Link ID:**

1. In the [Factory Default Restore](#) section, click [RESTORE](#).

**Factory Default Restore**

Restore all settings to default values.

---

Restore all configuration settings to default values, except your login and cloud account information.

[RESTORE](#)

2. Wait a few minutes for the resetting and rebooting.

 **Note:**

- During the resetting process, do not turn off the router.
- After reset, you can still use the current login password or the TP-Link ID to log in to the web management page.

- **To reset the router to factory default settings:**

1. Click [FACTORY RESTORE](#) to reset the router.

Restore all the configuration settings to their default values.

[FACTORY RESTORE](#)

2. Wait a few minutes for the resetting and rebooting.

 **Note:**

- During the resetting process, do not turn off or reset the router.
- We strongly recommend you backup the current configuration settings before resetting the router.

### 6.5.3. Change Password

You can change your login password of the web management page.

 **Note:** If you are using a TP-Link ID to log in to the web management page, the account management feature will be disabled. To manage the TP-Link ID, go to [Advanced](#) > [TP-Link ID](#).

1. Visit <http://tplinkwifi.net>, and log in with the password you set for the router.

2. Go to [Advanced](#) > [Administration](#) and focus on the [Change Password](#) section.

**Change Password**

Change the router's local management password.

---

Old Password:

New Password:

Confirm New Password:

3. Enter the old password, then a new password twice (both case-sensitive). Click [SAVE](#).

4. Use the new password for future logins.

#### 6.5.4. Local Management

This feature allows you to limit the number of client devices on your LAN from accessing the router by using the MAC address-based authentication.

1. Visit <http://tplinkwifi.net>, and log in with your TP-Link ID or the password you set for the router.
2. Go to [Advanced](#) > [Administration](#) and complete the settings in [Local Management](#) section as needed.

- **Local Management via HTTPS:**

Tick the [Local Management via HTTPS](#) checkbox to access the router via HTTPS and HTTP, or keep it disabled to access the router only via HTTP. Click [SAVE](#).

**Local Management**

Access and manage the router from local network devices.

---

Local Management via HTTPS:  Enable

- **Allow all LAN connected devices to manage the router:**

Select [All Devices](#) for [Local Managers](#). Click [SAVE](#).

**Local Management**

Access and manage the router from local network devices.

---

Local Management via HTTPS:  Enable

Local Managers:

- **Allow specific devices to manage the router:**

1. Select [Specified Devices](#) for [Local Managers](#).

**Local Management**  
Access and manage the router from local network devices.

Local Management via HTTPS:  Enable

Local Managers: Specified Devices

[+ Add Device](#)

Description	MAC Address	Operation
18101958-BG	B0-19-21-AA-B2-58	

2. Click [Add Device](#).

**Add Device** [X]

Description:

[VIEW CONNECTED DEVICES](#)

MAC Address:

[CANCEL](#) [SAVE](#)

3. Click [VIEW CONNECTED DEVICES](#) and select the device to manage the router from the Connected Devices list, or enter the MAC address of the device manually. Click [SAVE](#). The devices added will appear in the list.

4. Click [SAVE](#).

### 6.5.5. HTTP Referrer Head Check

HTTP referer header check function can protect your networks against CSRF attacks.

1. Visit <http://tplinkwifi.net>, and log in with your TP-Link ID or the password you set for the router.
2. Go to [Advanced](#) > [Administration](#), and locate the HTTP Referrer Head Check section.
3. HTTP Referrer Head Check is enabled by default, and it is recommended to keep the default settings. This feature protects your network against cross-site request forgery (CSRF) attacks.

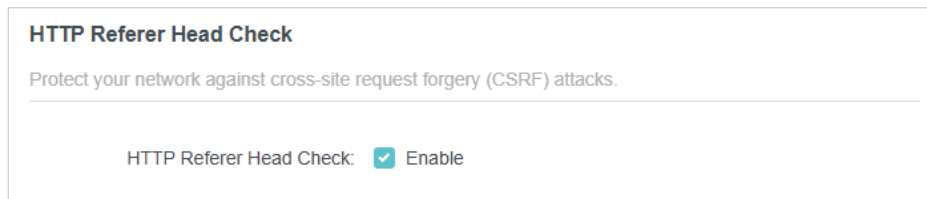

### 6.5.6. System Log

When the router does not work normally, you can save the system log and send it to the technical support for troubleshooting.

- **To save the system log locally:**

1. Visit <http://tplinkwifi.net>, and log in your TP-Link ID or the password you set for the router.
2. Go to [Advanced > System Log](#).
3. In the [Save Log](#) section, click **SAVE TO LOCAL** to save the system logs to a local disk.

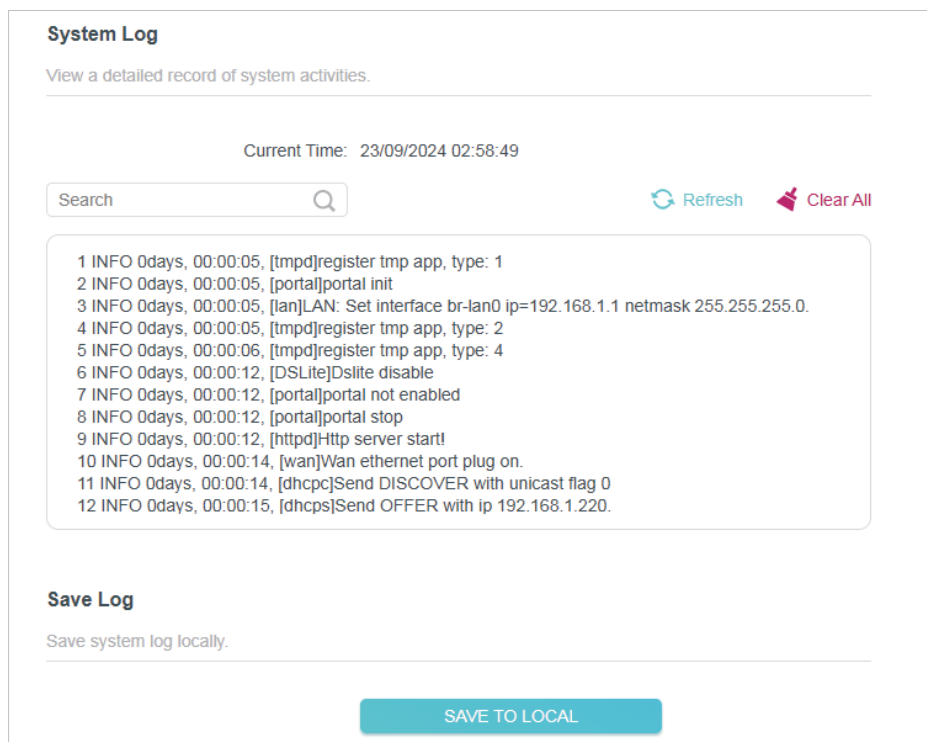

### 6.5.7. Diagnostics

Diagnostics is used to test the connectivity between the router and the host or other network devices.

1. Visit <http://tplinkwifi.net>, and log in with your TP-Link ID or the password you set for the router.

2. Go to [Advanced > Diagnostics](#).

## 3. Enter the information:

- 1) Choose [Ping](#) or [Traceroute](#) as the diagnostic tool to test the connectivity;
  - [Ping](#) is used to test the connectivity between the router and the tested host, and measure the round-trip time.
  - [Traceroute](#) is used to display the route (path) your router has passed to reach the tested host, and measure transit delays of packets across an Internet Protocol network.
- 2) Enter the [IP Address](#) or [Domain Name](#) of the tested host.
- 3) Modify the [Ping Packet Number](#) and the [Ping Packet Size](#). It's recommended to keep the default value.
- 4) If you have chosen [Traceroute](#), you can modify the [Traceroute Max TTL](#). It's recommended to keep the default value.

4. Click [START](#) to begin the diagnostics.

The figure below indicates the proper connection between the router and the Yahoo server (www.Yahoo.com) tested through [Ping](#).

```
Finding host www.yahoo.com by DNS server (1 of 2).
Pinging www.yahoo.com [69.147.80.15] with 64 bytes of data:
Reply from 69.147.80.15: bytes=64 time=233ms TTL=47 (seq=0).
Reply from 69.147.80.15: bytes=64 time=450ms TTL=47 (seq=1).
Reply from 69.147.80.15: bytes=64 time=383ms TTL=47 (seq=2).
Reply from 69.147.80.15: bytes=64 time=250ms TTL=47 (seq=3).
Ping statistics for 69.147.80.15:
    Packets: Sent = 4, Received = 4, Lost = 0 (0% loss),
    Approximate round trip times in milli-seconds:
        Minimum = 233ms, Maximum = 450ms, Average = 329ms
```

The figure below indicates the proper connection between the router and the Yahoo server (www.Yahoo.com) tested through [Traceroute](#).

```

Finding host www.yahoo.com by DNS server (1 of 2).
Tracing route to www.yahoo.com [69.147.80.12]
over a maximum of 20 hops:
 1 33 ms 16 ms 16 ms 192.168.194.221
 2 * * * Request timed out.
 3 100 ms 100 ms 100 ms 172.21.1.1
 4 83 ms 100 ms 100 ms 172.21.5.49
 5 * * 66 ms 172.21.5.9
 6 * 100 ms * 183.233.80.105
 7 * * 66 ms 221.183.53.97
 8 183 ms 83 ms 116 ms 221.183.167.30
 9 150 ms 150 ms 83 ms 221.183.92.214

```

### 6.5.8. Set System Time and Language

System time is the time displayed while the router is running. The system time you configure here will be used for other time-based functions like Parental Controls. You can choose the way to obtain the system time as needed.

System language is the language displayed when you log into the router. You can change the system language as needed.

1. Visit <http://tplinkwifi.net>, and log in with your TP-Link ID or the password you set for the router.
  2. Go to [Advanced > Time & Language](#).
- **To get time from the internet:**
    1. Enable [24-Hour Time](#) if you want the time to display in a 24-hour way.
    2. In the [Set Time](#) field, select [Get from Internet](#).

**System Time**

Set the router's system time.

---

Current Time: 23/09/2024 03:28:39

24-Hour Time:

Set Time:

Time Zone:

NTP Server I:

NTP Server II:  (Optional)

3. Select your local [Time Zone](#) from the drop-down list.
4. In the [NTP Server I](#) field, enter the IP address or domain name of your desired NTP Server.
5. (Optional) In the [NTP Server II](#) field, enter the IP address or domain name of the second NTP Server.
6. Click [SAVE](#).

- **To get time from your computer:**

1. In the **Set Time** field, select **Get from Managing Device**.

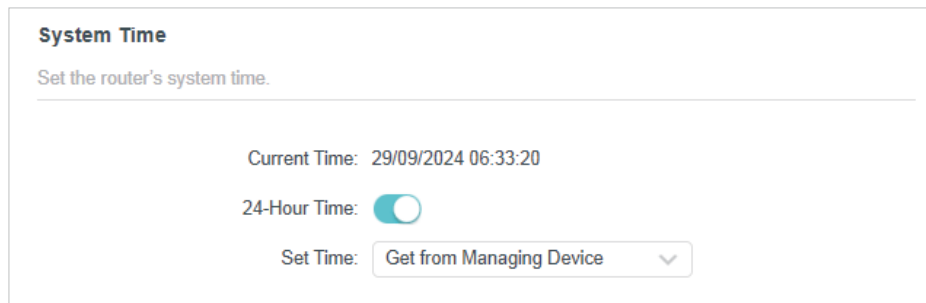

**System Time**  
Set the router's system time.

Current Time: 29/09/2024 06:33:20

24-Hour Time:

Set Time: **Get from Managing Device** ▼

2. The time of your computer will then be displayed and click **SAVE**.

- **To manually set the date and time:**

1. In the **Set Time** field, select **Manually**.

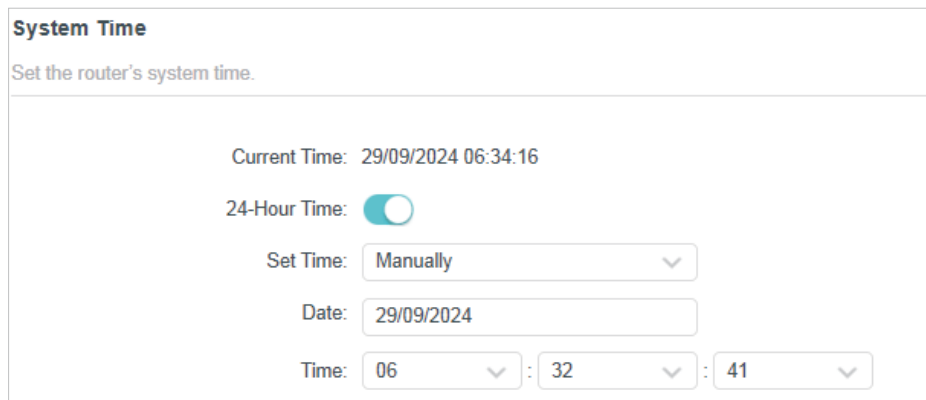

**System Time**  
Set the router's system time.

Current Time: 29/09/2024 06:34:16

24-Hour Time:

Set Time: **Manually** ▼

Date: 29/09/2024

Time: 06 ▼ : 32 ▼ : 41 ▼

2. Set the current **Date** (In **DD/MM/YYYY** format).
3. Set the current **Time** (In **HH/MM/SS** format).
4. Click **SAVE**.

- **To set Daylight Saving Time:**

1. Tick the **Enable** box of **Daylight Saving Time**.

### Daylight Saving Time

Automatically synchronize the system time with daylight saving time.

---

**Daylight Saving Time:**  Enable

Start: 2024

End: 2024

Running Status: Daylight Saving Time is off.

2. Select the correct **Start** date and time when daylight saving time starts at your local time zone.
3. Select the correct **End** date and time when daylight saving time ends at your local time zone.
4. Click **SAVE**.

- **To set system language:**

Select the language from the dropdown list, then click **SAVE**.

### Language

Set the router's system language.

---

Language:

## 6.5.9. Reboot & Reboot Schedule

- **To reboot the router:**

You can reboot the router to clear cache and enhance running performance.

1. Visit <http://tplinkwifi.net>, and log in with your TP-Link ID or the password you set for the router.
2. Go to **Advanced > Reboot**.
3. Click **REBOOT**.

### Reboot

Reboot to clear cache and enhance running performance.

---

- **To set reboot schedule:**

The Scheduled Reboot feature cleans the cache to enhance the running performance of the router.

1. Visit <http://tplinkwifi.net>, and log in with your TP-Link ID or the password you set for the router.
2. Go to [Advanced > Reboot](#).
3. Tick the [Enable](#) box of [Reboot Schedule](#).

**Reboot Schedule**  
Set when and how often the router reboots automatically.

**Reboot Schedule:**  Enable

**Note:** Make sure [Time Settings](#) are correct before using this function.

**Current Time:** 23/09/2024 03:34:40

Reboot Time: 03 : 00

Repeat: Every Week

Monday

4. Specify the [Reboot Time](#) when the router reboots and [Repeat](#) to decide how often it reboots.
5. Click [SAVE](#).

## 6.5.10. Control the LED

- **To turn off or turn on the LEDs:**

You can turn the router's LEDs on or off.

1. Visit <http://tplinkwifi.net>, and log in with your TP-Link ID or the password you set for the router.
2. Go to [Advanced > LED Control](#).
3. Toggle the [LED Status](#) button to turn on or turn off the LEDs.

**LED Control**  
Turn the router's LEDs on or off.

LED Status:

- **To enable Night Mode for the LEDs:**

The LED of the router indicates its activities and status. You can enable the Night Mode feature to specify a time period during which the LED is off.

1. Visit <http://tplinkwifi.net>, and log in with your TP-Link ID or the password you set for the router.
2. Go to [Advanced](#) > [LED Control](#).
3. Enable [Night Mode](#).
4. Specify the LED off time, and the LED will be off during this period every day.
5. Click [SAVE](#).

### Night Mode

Set a time period when the LEDs will be off automatically.

---

**Night Mode:**  Enable

**Note:** Make sure [Time Settings](#) are correct before using this function.

**Current Time:** 23/09/2024 03:35:23

LED Off From:  :

To:  :  (next day)

# FAQ

## Q1. What should I do if I forget my wireless password?

The default wireless password is printed on the label of the router. If the password has been altered, please connect your computer to the router using an Ethernet cable and follow the steps below:

1. Visit <http://tplinkwifi.net>, and log in with the username and password you set for the router.
2. Go to [Wireless](#) to retrieve or reset your wireless password.

## Q2. What should I do if I forget my login password of the Web-based Utility?

- If you are using a TP-Link ID to log in, or you have enabled the Password Recovery feature of the router, click [Forgot password](#) on the login page and then follow the instructions to reset it.
- Alternatively, press and hold the [Reset](#) button of the router for about 6 seconds until the Power LED blinks to restore factory default settings, and then visit <http://tplinkwifi.net> to create a new login password.

 Note:

- Please refer to [Change "Change Password"](#) to learn how to change Password.
- You'll need to reconfigure the router to surf the internet once the router is reset, and please mark down your new password for future use.

## Q3. What should I do if I cannot log in to the router's Web-based Utility?

This can happen for a variety of reasons. Please try the methods below to log in again.

- Make sure your computer has connected to the router correctly and the corresponding LED lights up.
- Make sure the IP address of your computer is configured as [Obtain an IP address automatically](#) and [Obtain DNS server address automatically](#).
- Make sure you enter the correct IP address to log in: <http://tplinkwifi.net> or 192.168.0.1.
- Check your computer's settings:
  - 1) Go to [Start](#) > [Control Panel](#) > [Network and Internet](#), and click [View network status and tasks](#).

- 2) Click [Internet Options](#) on the bottom left.
- 3) Click [Connections](#) and select [Never dial a connection](#).

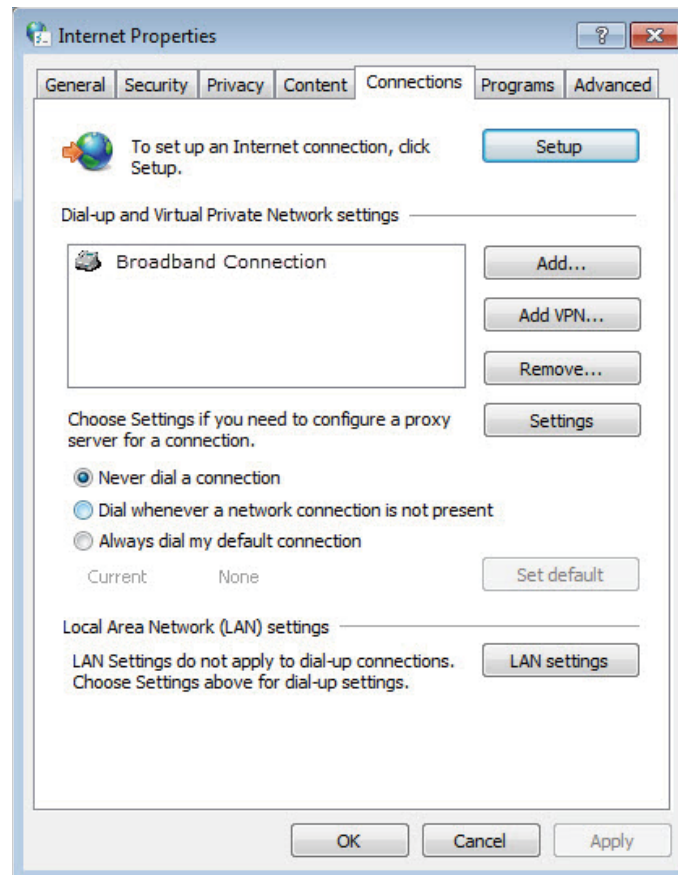

- 4) Click [LAN settings](#) and deselect the following three options, and click [OK](#).

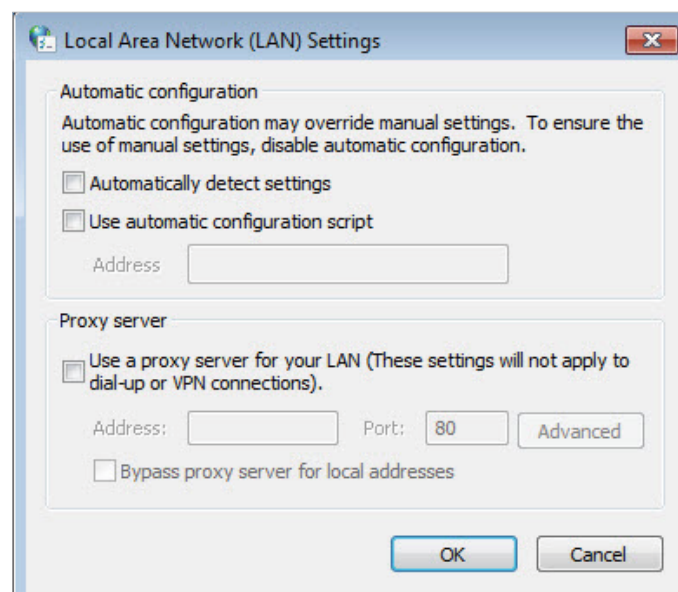

5) Go to **Advanced** > **Restore advanced settings**, and click **OK**.

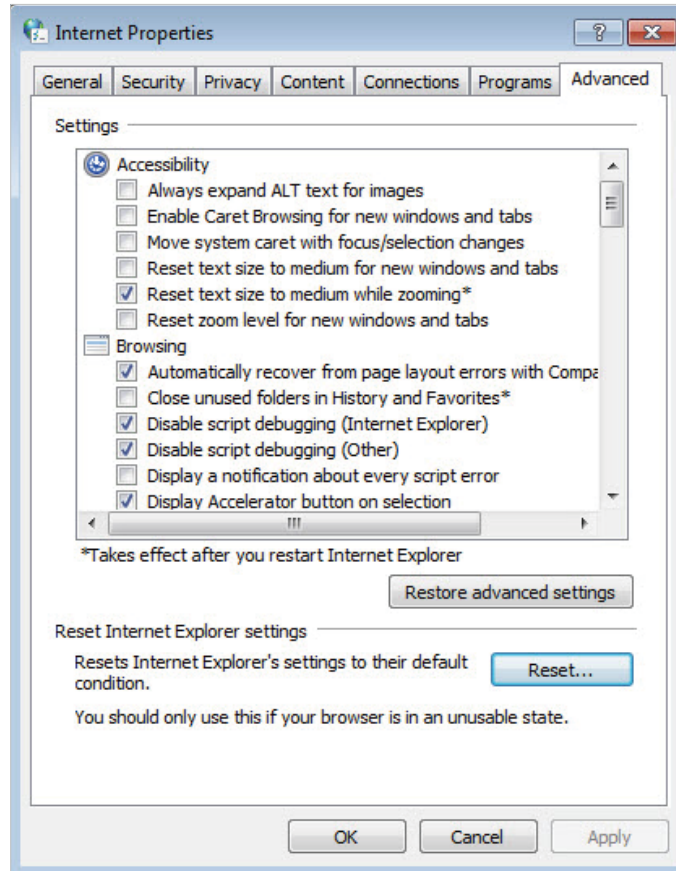

- Use another web browser or computer to log in again.
- Reset the router to factory default settings and try again. If the login still fails, please contact the technical support.

Note: You'll need to reconfigure the router to surf the internet once the router is reset.

#### Q4. What should I do if I cannot access the internet even though the configuration is finished?

1. Visit <http://tplinkwifi.net>, and log in to with the username and password you set for the router.
2. Go to **Advanced** > **Network** > **Status** to check Internet status:

**If IP Address is a valid one, please try the methods below and try again:**

- Your computer might not recognize any DNS server addresses, please manually configure DNS server.

- 1) Go to **Advanced** > **Network** > **DHCP Server**.
- 2) Enter 8.8.8.8 as Primary DNS, and click **Save**.

Tips: 8.8.8.8 is a safe and public DNS server operated by Google.

### DHCP Server

Dynamically assign IP addresses to the devices connected to the router.

---

DHCP Server:  Enable

IP Address Pool:  -

Address Lease Time:  minutes

Default Gateway:  (Optional)

Primary DNS:  (Optional)

Secondary DNS:  (Optional)

- Restart the modem and the router.
  - 1) Power off your modem and the router, and leave them off for 1 minute.
  - 2) Power on your modem first, and wait about 2 minutes.
  - 3) Power on the router, and wait another 1 or 2 minutes and check the Internet access.
- Reset the router to factory default settings and reconfigure the router.
- Upgrade the firmware of the router.
- Check the TCP/IP settings on the particular device if all other devices can get internet from the router.

**If the IP Address is 0.0.0.0, please try the methods below and try again:**

- Make sure the physical connection between the router and the modem is proper.
- Clone the MAC address of your computer.
  - 1) Visit <http://tplinkwifi.net>, and log in with the username and password you set for the router.
  - 2) Go to **Advanced > Network > Internet**, select **Clone Current Device MAC** and click **SAVE**.

### MAC Clone

Set the MAC address of your router. Use the default address unless your ISP allows internet only a specific MAC address.

---

Router MAC Address:

B0 - 19 - 21 - AA - B2 - 58

**Tips:**

- Some ISP will register the MAC address of your computer when you access the Internet for the first time through their Cable modem, if you add a router into your network to share your Internet connection, the ISP will not accept it as the MAC address is changed, so we need to clone your computer's MAC address to the router.
- The MAC addresses of a computer in wired connection and wireless connection are different.



- Modify the LAN IP address of the router.

 Note:

Most TP-Link routers use 192.168.0.1/192.168.1.1 as their default LAN IP address, it may conflict with the IP range of your existent ADSL modem/router. If so, the router is not able to communicate with your modem and cause you can't access the Internet. To resolve this problem, we need to change the LAN IP address of the router to avoid such conflict, for example, 192.168.2.1.

- 1) Visit <http://tplinkwifi.net>, and log in with the username and password you set for the router.
- 2) Go to [Advanced](#) > [Network](#) > [LAN](#).
- 3) Modify the LAN IP address as the follow picture shows. Here we take 192.168.2.1 as an example.
- 4) Click [Save](#).



**LAN**

View and configure LAN settings.

MAC Address: 00-19-66-CA-8B-07

IP Address:

Subnet Mask:  ▼

- Restart the modem and the router.
  - 1) Power off your modem and the router, and leave them off for 1 minute.
  - 2) Power on your modem first, and wait about 2 minutes.
  - 3) Power on the router, and wait another 1 or 2 minutes and check the internet access.
- Double check the Internet Connection Type.
  - 1) Confirm your Internet Connection Type, which can be learned from the ISP.
  - 2) Visit <http://tplinkwifi.net>, and log in with the username and password you set for the router.
  - 3) Go to [Advanced](#) > [Network](#) > [Internet](#).
  - 4) Select your [Internet Connection Type](#) and fill in other parameters.
  - 5) Click [Save](#).

**Internet**

Set up an internet connection with the service information provided by your ISP (internet service provider).

---

Internet Connection Type:

IP Address: 192.168.0.103

Subnet Mask: 255.255.255.0

Default Gateway: 192.168.0.1

Primary DNS: 192.168.0.1

Secondary DNS: 0.0.0.0

[▼ Advanced Settings](#)

DNS Address:

Primary DNS: 192.168.0.1

Secondary DNS: 0.0.0.0

MTU Size:  bytes

The default is 1500, do not change unless necessary.

Host Name:

Get IP with Unicast DHCP

6) Restart the modem and the router.

- Please upgrade the firmware of the router.

If you've tried every method above but cannot access the internet, please contact the technical support.

## Q5. What should I do if I cannot find my wireless network or I cannot connect to the wireless network?

If you fail to find any wireless network, please follow the steps below:

- Make sure the wireless function of your device is enabled if you're using a laptop with a built-in wireless adapter. You can refer to the relevant document or contact the laptop manufacturer.
- Make sure the wireless adapter driver is installed successfully and the wireless adapter is enabled.
  - **On Windows 7**
    - 1) If you see the message [No connections are available](#), it is usually because the wireless function is disabled or blocked somehow.

2) Clicking [Troubleshoot](#) and windows might be able to fix the problem by itself.

- **On Windows XP**

- 1) If you see the message [Windows cannot configure this wireless connection](#), this is usually because windows configuration utility is disabled or you are running another wireless configuration tool to connect the wireless.
- 2) Exit the wireless configuration tool (the TP-Link Utility, for example).
- 3) Select and right click [My Computer](#) on Desktop, and select [Manage](#) to open Computer Management window.
- 4) Expand [Services and Applications](#) > [Services](#), and find and locate [Wireless Zero Configuration](#) in the Services list on the right side.
- 5) Right click [Wireless Zero Configuration](#), and then select [Properties](#).
- 6) Change [Startup type](#) to [Automatic](#), click [Start](#) and make sure the Service status is [Started](#). And then click [OK](#).

**If you can find other wireless network except your own, please follow the steps below:**

- Make sure your computer/device is still in the range of your router/modem. Move closer if it is currently too far away.

**If you can find your wireless network but fail to connect, please follow the steps below:**

- **Authenticating problem/password mismatch:**

- 1) Sometimes you will be asked to type in a PIN number when you connect to the wireless network for the first time. This PIN number is different from the Wireless Password/Network Security Key. Usually you can only find it on the label of your router.



- 2) If you cannot find the PIN or PIN failed, you may choose [Connecting using a security key instead](#), and then type in the [Wireless Password/Network Security Key](#).
- 3) If it continues to show note of [Network Security Key Mismatch](#), it is suggested to confirm the wireless password of your wireless router.

 **Note:** Wireless Password/Network Security Key is case sensitive.

- **Windows unable to connect to XXXX / Can not join this network / Taking longer than usual to connect to this network:**
  - Check the wireless signal strength of your network, if it is weak (1~3 bars), please move the router closer and try again.
  - Change the wireless Channel of the router to 1,6,or 11 to reduce interference from other networks.
  - Re-install or update the driver for your wireless adapter of the computer.

## FCC compliance information statement



**Product Name:** AC750 Wireless Dual Band Router

**Model Number:** Archer C20

Component Name	Model
I.T.E POWER SUPPLY	T090060-2B1

**Responsible party:**

TP-Link Systems Inc.

Address: 10 Mauchly, Irvine, CA 92618

Website: <https://www.tp-link.com/us/>

Tel: +1 626 333 0234

Fax: +1 909 527 6804

E-mail: [sales.usa@tp-link.com](mailto:sales.usa@tp-link.com)

This equipment has been tested and found to comply with the limits for a Class B digital device, pursuant to part 15 of the FCC Rules. These limits are designed to provide reasonable protection against harmful interference in a residential installation. This equipment generates, uses and can radiate radio frequency energy and, if not installed and used in accordance with the instructions, may cause harmful interference to radio communications. However, there is no guarantee that interference will not occur in a particular installation. If this equipment does cause harmful interference to radio or television reception, which can be determined by turning the equipment off and on, the user is encouraged to try to correct the interference by one or more of the following measures:

- Reorient or relocate the receiving antenna.
- Increase the separation between the equipment and receiver.
- Connect the equipment into an outlet on a circuit different from that to which the receiver is connected.
- Consult the dealer or an experienced radio/ TV technician for help.

This device complies with part 15 of the FCC Rules. Operation is subject to the following two conditions:

1. This device may not cause harmful interference.
2. This device must accept any interference received, including interference that may cause undesired operation.

Any changes or modifications not expressly approved by the party responsible for compliance could void the user's authority to operate the equipment.

Note: The manufacturer is not responsible for any radio or TV interference caused by unauthorized modifications to this equipment. Such modifications could void the user's authority to operate the equipment.

### **FCC RF Radiation Exposure Statement**

This equipment complies with FCC RF radiation exposure limits set forth for an uncontrolled environment. This device and its antenna must not be co-located or operating in conjunction with any other antenna or transmitter.

"To comply with FCC RF exposure compliance requirements, this grant is applicable to only Mobile Configurations. The antennas used for this transmitter must be installed to provide a separation distance of at least 20 cm from all persons and must not be co-located or operating in conjunction with any other antenna or transmitter."

We, **TP-Link Systems Inc.**, has determined that the equipment shown as above has been shown to comply with the applicable technical standards, FCC part 15. There is no unauthorized change is made in the equipment and the equipment is properly maintained and operated.

Issue Date: 2025-03-05

### **FCC compliance information statement**

Product Name: I.T.E. Power Supply

Model Number: T090060-2B1

Responsible party:

TP-Link Systems Inc.

Address: 10 Mauchly, Irvine, CA 92618

Website: <https://www.tp-link.com/us/>

Tel: +1 626 333 0234

Fax: +1 909 527 6804

This equipment has been tested and found to comply with the limits for a Class B digital device, pursuant to part 15 of the FCC Rules. These limits are designed to provide reasonable protection against harmful interference in a residential installation. This equipment generates, uses and can radiate radio frequency energy and, if not installed and used in accordance with the instructions, may cause harmful interference to radio communications. However, there is no guarantee that interference will not occur in a particular installation. If this equipment does cause harmful interference to radio or television reception, which can be determined by turning the equipment off and on, the user is encouraged to try to correct the interference by one or more of the following measures:

- Reorient or relocate the receiving antenna.
- Increase the separation between the equipment and receiver.
- Connect the equipment into an outlet on a circuit different from that to which the receiver is connected.

- Consult the dealer or an experienced radio/ TV technician for help.

This device complies with part 15 of the FCC Rules. Operation is subject to the following two conditions:

1. This device may not cause harmful interference.
2. This device must accept any interference received, including interference that may cause undesired operation.

Any changes or modifications not expressly approved by the party responsible for compliance could void the user's authority to operate the equipment.

We, **TP-Link Systems Inc.**, has determined that the equipment shown as above has been shown to comply with the applicable technical standards, FCC part 15. There is no unauthorized change is made in the equipment and the equipment is properly maintained and operated.

Issue Date: 2025-03-05

## CE Mark Warning



This is a class B product. In a domestic environment, this product may cause radio interference, in which case the user may be required to take adequate measures.

### OPERATING FREQUENCY (the maximum transmitted power)

2400 MHz -2483.5 MHz(20dBm)

5150 MHz -5250 MHz(23dBm)

### EU declaration of conformity

TP-Link hereby declares that the device is in compliance with the essential requirements and other relevant provisions of directives 2014/53/EU, 2009/125/EC, 2011 /65/EU and (EU) 2015/863.

The original EU declaration of conformity may be found at <https://www.tp-link.com/en/support/ce/>

### RF Exposure Information

This device meets the EU requirements (2014/53/EU Article 3.1a) on the limitation of exposure of the general public to electromagnetic fields by way of health protection.

The device complies with RF specifications when the device used at 20 cm from your body.

### National Restrictions

Attention: This device may only be used indoors in all EU member states, EFTA countries and Northern Ireland.

Frequency band: 5150 - 5250 MHz:

Indoor use: Inside buildings only. Installations and use inside road vehicles and train carriages are not permitted. Limited outdoor use: If used outdoors, equipment shall not be attached to a fixed installation or to the external body of road vehicles, a fixed infrastructure or a fixed outdoor antenna. Use by unmanned aircraft systems (UAS) is limited to within the 5170 - 5250 MHz band.

	AT	BE	BG	CH	CY	CZ	DE	DK
	EE	EL	ES	FI	FR	HR	HU	IE
	IS	IT	LI	LT	LU	LV	MT	NL
	NO	PL	PT	RO	SE	SI	SK	UK(NI)

UKCA Mark



## UK Declaration of Conformity

TP-Link hereby declares that the device is in compliance with the essential requirements and other relevant provisions of the Radio Equipment Regulations 2017.

The original UK declaration of conformity may be found at <https://www.tp-link.com/support/ukca/>

## National restrictions

Attention: This device may only be used indoors in Great Britain.



## Canadian Compliance Statement

This device contains licence-exempt transmitter(s)/receiver(s) that comply with Innovation, Science and Economic Development Canada's licence-exempt RSS(s). Operation is subject to the following two conditions:

- (1) This device may not cause interference.
- (2) This device must accept any interference, including interference that may cause undesired operation of the device.

L'émetteur/récepteur exempt de licence contenu dans le présent appareil est conforme aux CNR d'Innovation, Sciences et Développement économique Canada applicables aux appareils radio exempts de licence. L'exploitation est autorisée aux deux conditions suivantes :

- 1) L'appareil ne doit pas produire de brouillage;
- 2) L'appareil doit accepter tout brouillage radioélectrique subi, même si le brouillage est susceptible d'en compromettre le fonctionnement.

## Caution:

1. The device for operation in the band 5150–5250 MHz is only for indoor use to reduce the potential for harmful interference to co-channel mobile satellite systems;

## Avertissement:

1. Le dispositif fonctionnant dans la bande 5150–5250 MHz est réservé uniquement pour une utilisation à l'intérieur afin de réduire les risques de brouillage préjudiciable aux systèmes de satellites mobiles utilisant les mêmes canaux;

## Radiation Exposure Statement:

This equipment complies with IC radiation exposure limits set forth for an uncontrolled environment. This equipment should be installed and operated with minimum distance 20cm between the radiator & your body.

## Déclaration d'exposition aux radiations:

Cet équipement est conforme aux limites d'exposition aux rayonnements IC établies pour un environnement non contrôlé. Cet équipement doit être installé et utilisé avec un minimum de 20 cm de distance entre la source de rayonnement et votre corps.

## Industry Canada Statement

CAN ICES-3 (B)/NMB-3(B)



## Korea Warning Statements:

당해 무선설비는 운용중 전파혼신 가능성이 있음.

## NCC Notice & BSMI Notice:

注意!

取得審驗證明之低功率射頻器材，非經核准，公司、商號或使用者均不得擅自變更頻率、加大功率或變更原設計之特性及功能。

低功率射頻器材之使用不得影響飛航安全及干擾合法通信；經發現有干擾現象時，應立即停用，並改善至無干擾時方得繼續使用。

前述合法通信，指依電信管理法規定作業之無線電通信。

低功率射頻器材須忍受合法通信或工業、科學及醫療用電波輻射性電機設備之干擾。

應避免影響附近雷達系統之操作。

高增益指向性天線只得應用於固定式點對點系統。

## 安全諮詢及注意事項

- 請使用原裝電源供應器或只能按照本產品注明的電源類型使用本產品。
- 清潔本產品之前請先拔掉電源線。請勿使用液體、噴霧清潔劑或濕布進行清潔。
- 注意防潮，請勿將水或其他液體潑灑到本產品上。
- 插槽與開口供通風使用，以確保本產品的操作可靠並防止過熱，請勿堵塞或覆蓋開口。
- 請勿將本產品置放於靠近熱源的地方。除非有正常的通風，否則不可放在密閉位置中。

- 不要私自拆開機殼或自行維修，如產品有故障請與原廠或代理商聯繫。

設備名稱：AC750 Wireless Dual Band Router Equipment name			型號（型式）：Archer C20 Type designation (Type)			
單元 Unit	限用物質及其化學符號 Restricted substances and its chemical symbols					
	鉛 Lead (Pb)	汞 Mercury (Hg)	鎘 Cadmium (Cd)	六價鉻 Hexavalent chromium (Cr <sup>6+</sup> )	多溴聯苯 Polybrominated biphenyls (PBB)	多溴二苯醚 Polybrominated diphenyl ethers (PBDE)
PCB	○	○	○	○	○	○
外殼	○	○	○	○	○	○
電源供應器	—	○	○	○	○	○
天線	○	○	○	○	○	○
<p>備考 1. “超出 0.1 wt %” 及 “超出 0.01 wt %” 係指限用物質之百分比含量超出百分比含量基準值          Note 1: “Exceeding 0.1 wt %” and “exceeding 0.01 wt %” indicate that the percentage content of the restricted substance exceeds the reference percentage value of presence condition.</p> <p>備考 2. “○” 係指該項限用物質之百分比含量未超出百分比含量基準值。          Note 2: “o” indicates that the percentage content of the restricted substance does not exceed the percentage of reference value of presence.</p> <p>備考 3. “—” 係指該項限用物質為排除項目。          Note 3: The “-” indicates that the restricted substance corresponds to the exemption.</p>						

運作溫度: 0°C~40°C (32°F~104°F)



Продукт сертифіковано згідно с правилами системи УкрСЕПРО на відповідність вимогам нормативних документів та вимогам, що передбачені чинними законодавчими актами України.



## Safety Information

- Keep the device away from water, fire, humidity or hot environments.
- Do not attempt to disassemble, repair, or modify the device. If you need service, please contact us.
- Do not use damaged charger or USB cable to charge the device.
- Do not use any other chargers than those recommended
- Do not use the device where wireless devices are not allowed.
- Adapter shall be installed near the equipment and shall be easily accessible.
- Use only power supplies which are provided by manufacturer and in the original packing of this product. If you have any questions, please don't hesitate to contact us.











- This product uses radios and other components that emit electromagnetic fields. Electromagnetic fields and magnets may interfere with pacemakers and other implanted medical devices. Always keep the product and its power adapter more than 15 cm (6 inches) away from any pacemakers or other implanted medical devices. If you suspect your product is interfering with your pacemaker or any other implanted medical device, turn off your product and consult your physician for information specific to your medical device.
- Operating Temperature: Operating Temperature: 0°C~40°C (32°F~104°F)













Please read and follow the above safety information when operating the device. We cannot guarantee that no accidents or damage will occur due to improper use of the device. Please use this product with care and operate at your own risk.

### Explanation of the symbols on the product label

Symbols may vary from products.

Note: The product label can be found at the bottom of the product and its I.T.E. power supply.

Symbol	Explanation
	Class II equipment
	Class II equipment with functional earthing
	Alternating current
	DC voltage
	Polarity of output terminals
	Indoor use only
	Dangerous voltage
	Caution, risk of electric shock
	Energy efficiency Marking
	Protective earth
	Earth

Symbol	Explanation
	Frame or chassis
	Functional earthing
	Caution, hot surface
	Caution
	Operator's manual
	Stand-by
	"ON"/"OFF" (push-push)
	Fuse
	Fuse is used in neutral N
	<p>RECYCLING</p> <p>This product bears the selective sorting symbol for Waste electrical and electronic equipment (WEEE). This means that this product must be handled pursuant to European directive 2012/19/EU in order to be recycled or dismantled to minimize its impact on the environment.</p> <p>User has the choice to give his product to a competent recycling organization or to the retailer when he buys a new electrical or electronic equipment.</p>
	Caution, avoid listening at high volume levels for long periods
	Disconnection, all power plugs
m	Switch of mini-gap construction
μ	Switch of micro-gap construction (for US version) Switch of micro-gap / micro-disconnection construction (for other versions except US)
ε	Switch without contact gap (Semiconductor switching device)

## Appendix: 定位您的路由器

- 產品不應放置在會受潮濕或過高溫度的地方。
- 將路由器放置在能夠連接多個設備並接上電源的地方。
- 請確保線和電源線放置在安全位置，以免造成絆倒的危險。
- 將路由器遠離具有強烈電磁干擾的設備，例如藍牙設備、無線電話和微波爐。
- 通常，路由器放置在水平的表面上，例如在架子上或桌面上。
- 該設備還可以安裝在牆上，如下圖所示。

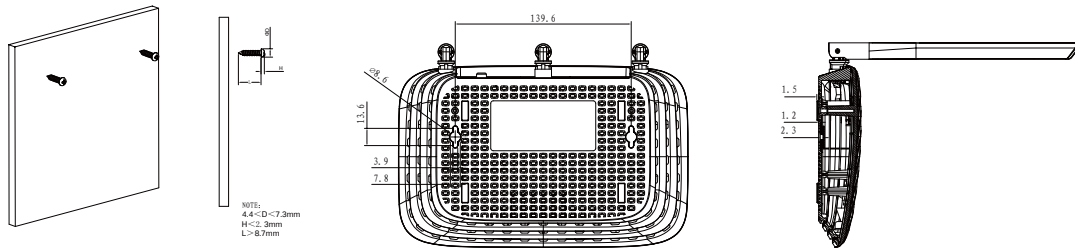

### 注意：

螺絲頭直徑為 $4.4\text{mm} < D < 7.3\text{mm}$ ，兩個螺絲之間的距離為 $139.6\text{mm}$ 。從牆壁突出的螺絲需要約 $5\text{mm}$ 的基底，並且螺絲的長度至少需要 $8.7\text{mm}$ 才能承受產品的重量。