

SENCOR®

SLE XXX801TCSB

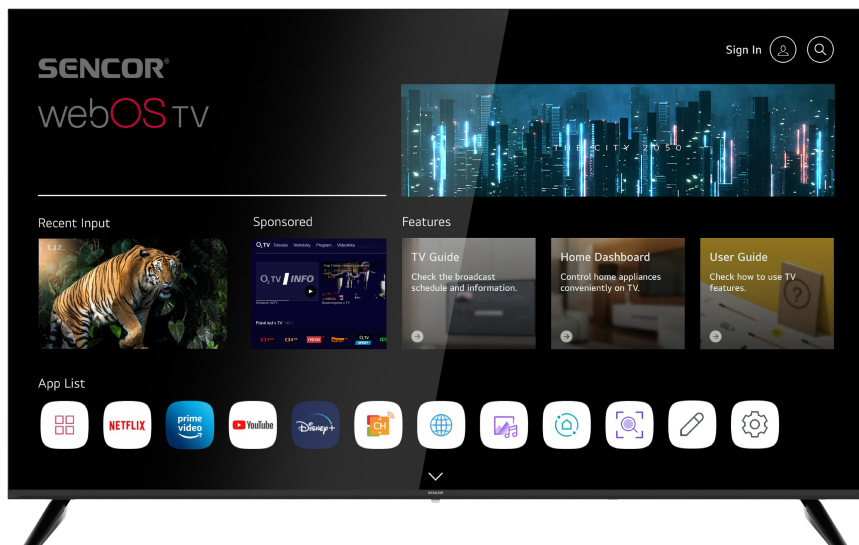

EN ■ QUICK GUIDE

CZ ■ RYCHLÝ PRŮVODCE

SK ■ RÝCHLY SPRIEVODCA

HU ■ GYORS ÚTMUTATÓ

PL ■ KRÓTKI PRZEWODNIK

LED TV

LED TV

LED TV

LED TV

LED TV

English	3
Čeština	9
Slovenčina	15
Magyar	21
Polski	27
Product Information Sheet	33
Informační list produktu	33
Informačný list produktu	33
Termékinformációs lap	33
Arkusz informacji o produkcie	33

LICENSES:



1. Safety instructions

To be able to use this product properly, read this user's manual carefully and keep it for future reference. If you plan to give (sell) this device to a third person, include all documentation, including this manual, with the transaction.



The lightning symbol inside a triangle indicates the device has dangerous voltage that may cause electric shock.



The exclamation point symbol inside an isosceles triangle indicates important operation and repair instructions in the included device documentation.

WARNING

RISK OF ELECTRIC SHOCK – DO NOT OPEN!

TO REDUCE THE RISK OF ELECTRIC SHOCK, DO NOT REMOVE THE COVER (OR BACK SIDE). THERE ARE NO PARTS INSIDE THE DEVICE REPLACEABLE BY THE USER. FOR REPAIRS, CONTACT AND AUTHORIZED SERVICE PROVIDER.

WARNING:

To prevent risk of fire or electric shock, do not expose the device to rain or moisture. The batteries must not be exposed to excessive heat, for example sunlight, fire, etc.



This symbol indicates the device has double insulation between dangerous voltage from the network and user-accessible parts. Replace parts with identical spare parts only.

- Do not leave a static image on the LCD panel for more than 2 hours. The panel might get damaged.

- LCD screens are made using precision technology to provide even the finest image details. Several defective pixels can appear on the screen from time to time, indicated as red, blue, green or black dots (up to 0.001% of the total pixel count of the screen). This does not affect the characteristics and the effectiveness of your TV set.

Before use, please read the detailed safety information in the full user manual available on the website www.sencor.com

2. Installing the stand

Use the supplied or recommended screws to attach the stand. Make sure the supports are properly attached to keep the TV stable. Then connect the TV to the power supply.

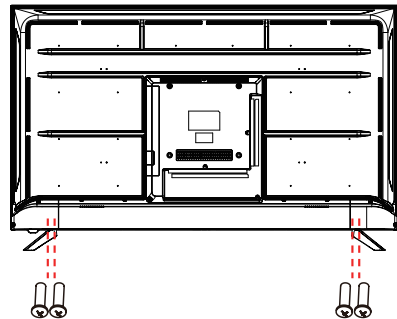

3. Inserting batteries

Open the battery compartment. Insert two AAA batteries. Place the cover back on. Insert two AA batteries into the Magic controller (UHD models only).

4. TV connectors

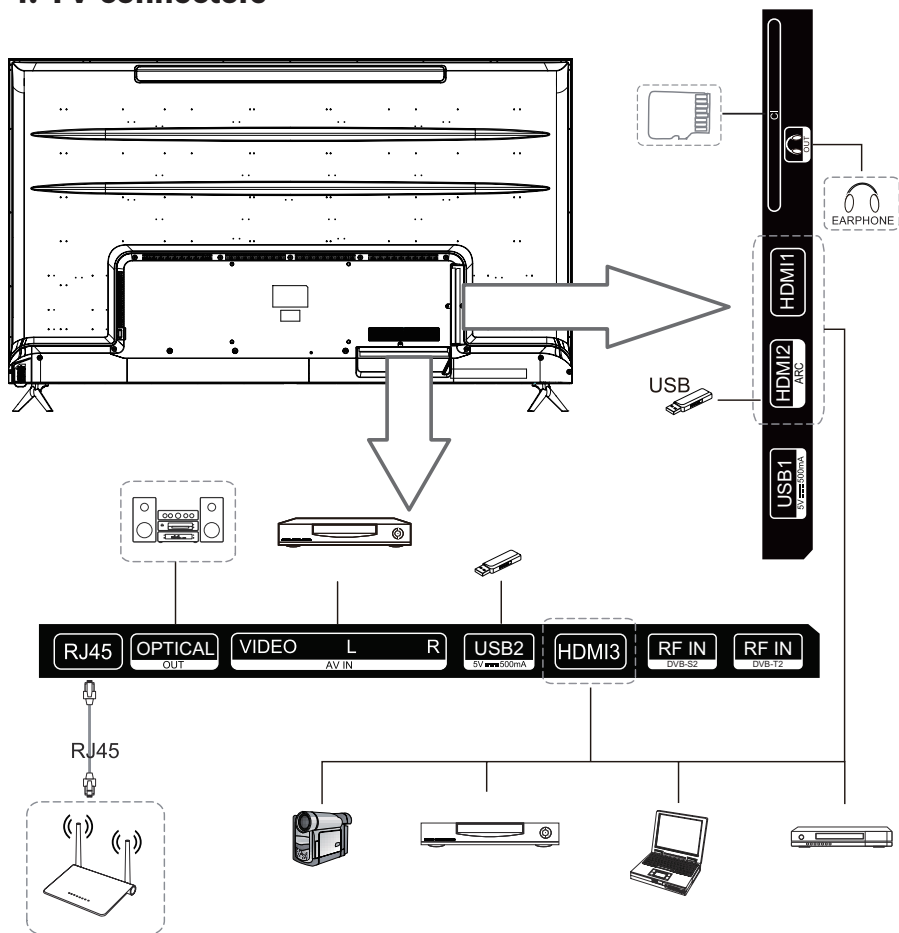

5. Remote controller

POWER: power ON/OFF.

TV/RAD: Switch to TV or radio.

Q: Search.

SUBTITLE: Subtitles On/Off.

⚙️: Enter the quick setup menu.

📺: Input source selection.

0-9: Numeric keys.

LIST: Channel list.

⋮: Show other actions.

🔊: Setting the volume.

📺: Channel switching.

AD: Enabling / disabling the AD function.

GUIDE: TV programme display.

🔇: Mute.

▶️: Play.

🏠: Shows main menu.

⏸️: Pause.

BACK: Back to the previous step.

EXIT: Closes the menu.

🕒: Selects the currently highlighted option.

⬅️/➡️/⬆️/⬇️: The RIGHT/LEFT/UP/DOWN buttons to move through the menu.

TEXT: Opens teletext.

T.OPT: Open the teletext function menu.

MOVIES: Movie search.

REC: Starts recording.

🎞️: Starts live playback.

NETFLIX: launches Netflix.

prime video: launches Prime video.

🔴 🟢 🟡 🔵: Correspond various color functions in the menu or in the teletext.



6. Magic Controller

When paired with the TV, the Magic controller offers an additional cursor for control.

: TV ON/OFF.

: STB ON/OFF.

1-9: numeric keys

: Channel list

QUICK ACCESS: Short press: Number button / Long press: Quick access

AD/SAP: Short press: Other actions
Long press: Audio description

: Mute.

: Setting the volume.

: Channel switching.

: Activates voice recognition.

: Shows main menu.

: Enter the quick setup menu.

WHEEL UP: Scroll up / Go to a higher channel

PRESSING THE WHEEL: Confirmation

WHEEL DOWN: Scroll down / Go to a lower channel

RIGHT/LEFT/UP/DOWN: The RIGHT/LEFT/UP/DOWN buttons to move through the menu.

: Go back.

GUIDE: TV programme display.

: Input source selection.





MOVIES: Movie selection menu.

: Play.

: Pause.

NETFLIX: launches Netflix.

prime video: launches Prime video.

   : Correspond various color functions in the menu or in the teletext.

The icons and positions of the remote control buttons may vary depending on the model.



7. TV control buttons

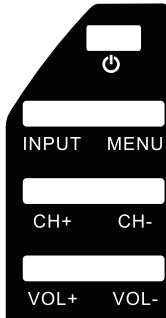

 TV ON/OFF.

INPUT: Source selection.

MENU: Enters main menu.

CH+: Channel selection.

CH-: Channel selection.

VOL+: Volume up.

VOL-: Volume down.

8. After you first turn on the TV

When you first turn on your TV, you'll see a welcome screen where you can select your language and country. Next, select the signal source and perform the initial tuning as instructed on the screen.

9. Included accessories

- Magic Remote (UHD models only)
- Basic remote controller
- Quick guide
- 2 AAA batteries, 2 AA batteries (for Magic controller only)
- Stand and fixing screws

10. Playing from USB disc

Connect a USB device. Press HOME on the remote controller. Open the Photo & Video app. Select the desired storage device. Select and view the desired photo or video.

Compatibility with all USB devices is not guaranteed. Use file system FAT32/NTFS, single partition, no protection. Formatting permanently erases all contents of the memory device! First, test the speed and reliability of each USB device. When the result is unsatisfactory, replace it with another one, mainly faster. The speed of a USB storage device is a prerequisite for reliable recording and time-shifting.

Supported USB formats

Video: AVI, MP4, MPG, MKV, MOV, DAT, VOB

Audio: MP3, WAV, OGG, FLAC

Pictures: JPEG, JPG, PNG

11. Full text of the operating instructions

The full instruction manual is available at www.sencor.com or directly on the TV.

INSTRUCTIONS AND INFORMATION REGARDING THE DISPOSAL OF USED PACKAGING

Dispose of the packaging material at a public waste disposal site.



DISPOSAL OF USED ELECTRICAL AND ELECTRONIC EQUIPMENT

The symbol on the product, its accessories or packaging indicates that the product must not be disposed of in household waste. Dispose of the equipment at an appropriate collection point for the recycling of electrical and electronic equipment. Alternatively, in some European Union states or other European countries you may return your products to your local retailer when buying an equivalent new product.

Correct disposal of this product will help save valuable natural resources and prevent any potential negative impacts on the environment and human health, which could otherwise be caused by improper waste disposal. Contact your local authority or nearest waste collection centre for more details. Improper disposal of this type of waste may be subject to national rules on fines.

For business entities in the European Union

To dispose of electrical or electronic device, request the necessary information from your vendor or supplier.

Disposal in other countries outside the European Union

To dispose of this product, request the necessary information about the correct disposal method from local government departments or from your vendor.



Hereby FAST CR, a.s. declares that the type of SLE 65US801TCSB, SLE 55US801TCSB, SLE 50US801TCSB, SLE 43US801TCSB, SLE 43FS801TCSB, SLE 32S801TCSB and SLE 24S801TCSB are in compliance with Directive 2014/53/EU.

The full text of the EU Declaration of Conformity is available at the following website: www.sencor.com

Text, design and technical specifications are subject to change without notice and we reserve the right to make changes.

Product Information Sheet

COMMISSION DELEGATED REGULATION (EU) 2019/2013

#	INFORMATION	Value	Value	Value	Value	Unit
1	Supplier name or trademark	SENCOR	SENCOR	SENCOR	SENCOR	
2	Model identifier	SLE 32S801TCSB	SLE 43FS801TCSB	SLE 43US801TCSB	SLE 50US801TCSB	
3	Energy Efficiency Class for standard Dynamic Range (SDR)	E	F	F	G	
4	On mode power demand for Standard Dynamic Range (SDR)	25	43	51	68	W
5	Energy Efficiency Class for standard Dynamic Range (HDR)	G	G	G	G	
6	On mode power demand in High Dynamic Range (HDR) mode	39	59	69	103	W
7	Off mode, power demand	0	0	0	0	W
8	Standby mode power demand	0.3	0.4	0.3	0.3	W
9	Networked standby mode power demand	0.7	0.5	0.4	0.5	W
10	Electronic display category	Television	Television	Television	Television	
11	Size ratio	16 : 9	16 : 9	16 : 9	16 : 9	
12	Screen resolution (pixels)	1366 x 768	1920 x 1080	3840 x 2160	3840 x 2160	pixels
13	Screen diagonal	80	108	108	126	cm
14	Screen diagonal	32	43	43	50	inches
15	Visible screen area	27,4	49,8	49,9	67,6	dm ²
16	Panel technology used	LED LCD	LED LCD	LED LCD	LED LCD	
17	Automatic Brightness Control (ABC) available	No	No	No	No	
18	Voice recognition sensor available	No	No	No	No	
19	Room presence sensor available	No	No	No	No	
20	Image refresh frequency rate	60	60	60	60	Hz
21	Minimum guaranteed availability of software and firmware updates (years)	8	8	8	8	
22	Minimum guaranteed availability of spare parts (years)	7	7	7	7	
23	Minimum guaranteed product support (years)	8	8	8	8	
	Minimum duration of the general guarantee offered by the supplier	2	2	2	2	
24	Power supply type:	Internal	Internal	Internal	Internal	
i.	External standardised power supply (included in the product box)	Standard name	N/A	N/A	N/A	N/A
	Input voltage	N/A	N/A	N/A	N/A	V
	Output voltage	N/A	N/A	N/A	N/A	V
ii.	External standardised suitable power supply (if not included in the product box)	Standard name	N/A	N/A	N/A	N/A
	Required output voltage	N/A	N/A	N/A	N/A	V
	Required delivered current	N/A	N/A	N/A	N/A	A
	Required current frequency	N/A	N/A	N/A	N/A	Hz

#	INFORMATION		Value	Value	Unit
1	Supplier name or trademark		SENCOR	SENCOR	
2	Model identifier		SLE 55US801TCSB	SLE 65US801TCSB	
3	Energy Efficiency Class for standard Dynamic Range (SDR)		G	G	
4	On mode power demand for Standard Dynamic Range (SDR)		82	105	W
5	Energy Efficiency Class for standard Dynamic Range (HDR)		G	G	
6	On mode power demand in High Dynamic Range (HDR) mode		122	114	W
7	Off mode, power demand		0	0	W
8	Standby mode power demand		0.3	0.3	W
9	Networked standby mode power demand		0.3	0.5	W
10	Electronic display category		Television	Television	
11	Size ratio		16 : 9	16 : 9	
12	Screen resolution (pixels)		3840 x 2160	3840 x 2160	pixels
13	Screen diagonal		139	164	cm
14	Screen diagonal		55	65	inches
15	Visible screen area		82,3	114,8	dm ²
16	Panel technology used		LED LCD	LED LCD	
17	Automatic Brightness Control (ABC) available		No	No	
18	Voice recognition sensor available		No	No	
19	Room presence sensor available		No	No	
20	Image refresh frequency rate		60	60	Hz
21	Minimum guaranteed availability of software and firmware updates (years):		8	8	
22	Minimum guaranteed availability of spare parts (years)		7	7	
23	Minimum guaranteed product support (years)		8	8	
	Minimum duration of the general guarantee offered by the supplier		2	2	
24	Power supply type:		Internal	Internal	
i.	External standardised power supply (included in the product box)	Standard name	N/A	N/A	
	Input voltage		N/A	N/A	V
	Output voltage		N/A	N/A	V
ii.	External standardised suitable power supply (if not included in the product box)	Standard name	N/A	N/A	
	Required output voltage		N/A	N/A	V
	Required delivered current		N/A	N/A	A
	Required current frequency		N/A	N/A	Hz

#	CZ	SK	HU	PL
1	Název nebo ochranná známka dodavatele	Názov dodávateľa alebo jeho ochranná známka	A szállító neve vagy védjegye	Nazwa dostawcy lub znaktowarowy;
2	Identifikační značka modelu dodavatele	Identifikačný kód modelu dodávateľa	A szállító által megadottmodellazonosító	Identyfikator modelu udostawcy
3	Třída energetické účinnosti u standardního dynamické horozsahu (SDR)	Trieda energetickej účinnosti pre štandardný dynamický rozsah (SDR)	Energiiahatékonysági osztályszabványos dinamikataromány (SDR) esetén	Klasa efektywności energetycznej dla standardowego zakresu dynamicznego (SDR)
4	Příkon v zapnutém stavu u standardního dynamické horozsahu (SDR)	Příkon v režime zapnutia pre štandardný dynamický rozsah (SDR)	Bekapcsolt üzemmóde-nergiaigénye szabványos-dinamikataromány (SDR) esetén	Pobór mocy w trybie włączenia dla standardowego zakresu dynamicznego (SDR)
5	Třída energetické účinnosti (HDR)	Trieda energetickej účinnosti (HDR)	Energiiahatékonysági osztály(HDR)	Klasa efektywności energetycznej (HDR)
6	Příkon v zapnutém stavu v režimu vysoce dynamického rozsahu (HDR)	Příkon v režime zapnutia pre vysoký dynamický rozsah (HDR)	Bekapcsolt üzemmódeenergiaigénye nagydinamikataromány (HDR) esetén	Pobór mocy w trybie włączenia dla szerokiego zakresu dynamicznego (HDR)
7	Vypnutý stav, příkon	Příkon v režime vypnutia	Kikapcsolt üzemmód,energiaigény	Pobór mocy w trybie wyłączenia
8	Příkon v pohotovostním režimu	Příkon v režime pohotovosti	Készletli üzemmód,energiaigény	Pobór mocy w trybieczuwania
9	Příkon v síťovém pohotovostním režimu	Příkon v režime pohotovosti pri zapojení v sieti	Hálózatvezérelt készletli üzemmód, energiaigény	Pobór mocy w trybieczuwania przy podłączeniu do sieci
10	Kategorie elektronickéhodiespleje	Kategória elektronického displeja	Elektronikus kijelző kategóriája	Kategoria wyświetlacz elektronicznego
11	Poměr stran	Pomer strán	Oldalarány	Format obrazu
12	Rozlišení obrazovky (vpixelech)	Rozlíšenie zobrazovacej jednotky (pixeli)	Képernyőfelbontás (képpontok)	Rozdzielczość ekranu (piksele)
13	Úhlopříčka obrazovky	Uhlopriečka zobrazovacej	Képtű	Przekątna ekranu
14	Úhlopříčka obrazovky	Uhlopriečka zobrazovacej	Képtű	Przekątna ekranu
15	Viditelná plocha obrazovky	Viditeľná plocha zobrazovacej	Látható képernyőterület	Widoczna powierzchnia ekranu
16	Použitá technologie panelů	Použitá technológia panelu	Alkalmazott paneltechnológia	Zastosowana technologia panelu
17	Dostupné automatické ovládání jasu (ABC)	K dispozícii je automatická regulácia jasu (ABC)	Automatikus fényerőszabályozó (ABC) rendelkezésre áll	Dostępność funkcji automatycznej regulacji jasności (ABC)
18	Dostupný snímač pro rozpoznávání hlasu	K dispozícii je snímač rozpoznávania reči	Hangfelismerő érzékelőrendelkezésre áll	Dostępność czujnika rozpoznawania mowy
19	Dostupný detektor přítomnosti v místnosti	K dispozícii je snímač přítomnosti v miestnosti	Jelenlétérzékelő rendelkezésre áll	Dostępność czujników obecności w pomieszczeniu
20	Obnovovací frekvence obrazu	Obnovovací kmitočet obrazovky	Képfrekvencia	Częstotliwość odświeżania obrazu
21	Minimální zaručená dostupnost aktualizací softwaru a firmwaru (do):	Minimálna zaručená dostupnosť aktualizácií softvéru a firmvéru (do):	A szoftver- és firmware-frissítések garantált rendelkezésre állása legalább eddig (dátum):	Minimalna gwarantowana dostępność aktualizacji oprogramowania i oprogramowania układowego (do):
22	Minimální zaručená dostupnost náhradních dílů (do):	Minimálna zaručená dostupnosť náhradných dielov (do):	A tartalék alkatrészek garantált rendelkezésre állása legalább eddig (dátum):	Minimalna gwarantowana dostępność części zamiennych (do):

#	CZ	SK	HU	PL
23	Minimální garantovaná podpora výrobku (do):	Minimálna zaručená podpora výrobkov (do):	Garantált terméktámogatás legalább eddig (dátum):	Minimalne gwarantowane wsparcie produktu (do):
24	Typ napájení:	Typ zdroja napájania:	A tápegység típusa:	Typ zasilacza:
i.	Normalizovaný vnější napájecí zdroj (jako součást balení výrobku) Standardní název	Externý normalizovaný zdroj napájania (ktorý je súčasťou balenia výrobku) Štandardný názov	Szabványos külső áramforrás (a termékdobozban) Szabvány neve	Znormalizowany zasilacz zewnętrzny (dostarczony w opakowaniu z produktem) Tytuł normy
	Vstupní napětí	Vstupné napätie	Bemeneti feszültség	Napięcie wejściowe
	Výstupní napětí	Výstupné napätie	Kimeneti feszültség	Napięcie wyjściowe
ii.	Vhodný normalizovaný vnější napájecí zdroj (pokud není součástí balení výrobku) Standardní název	Externý normalizovaný vhodný zdroj napájania (ak nie je súčasťou balenia výrobku) Štandardný názov	Külső, szabványos megfelelő áramforrás (ha a termékdoboznak nem része) Szabvány neve	Odpowiedni znormalizowany zasilacz zewnętrzny (jeżeli nie jest dostarczony w opakowaniu z produktem) Tytuł normy
	Požadované výstupní napětí	Požadované výstupné napätie	Előírt kimeneti feszültség	Wymagane napięcie wyjściowe
	Požadovaný dodávaný proud	Požadovaný prúd	Előírt szállított áram	Wymagane natężenie prądu
	Požadovaný kmitočet proudu	Požadovaná frekvencia prúdu	Előírt áramfrekvencia	Wymagana częstotliwość prądu