

FRIGIDAIRE

Use & Care

TABLE OF CONTENTS

Product Registration.....	2	Energy-Saving Tips.....	7
Important Safety Instructions.....	2	Care and Cleaning.....	8
First Steps.....	4	Before You Call.....	9
Setting the Temperature Control.....	6	Major Appliance Warranty.....	11
Optional Features.....	6		

PRODUCT REGISTRATION

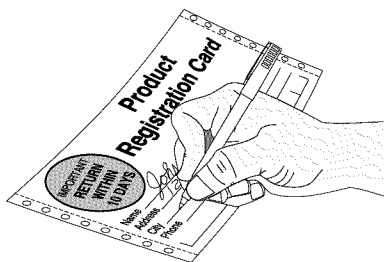

Read and Save These Instructions

This Owner's Guide provides specific operating instructions for your model. Use your appliance only as instructed in this guide. These instructions are not meant to cover every possible condition and situation that may occur. Common sense and caution must be practiced when installing, operating, and maintaining any appliance.

Record Your Model and Serial Numbers

Record the model and serial numbers in the space provided below.

Model Number: _____

Serial Number: _____

Purchase Date: _____

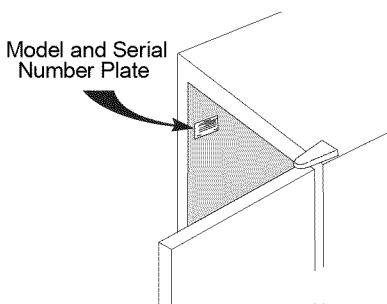

Register Your Product

The self-addressed **PRODUCT REGISTRATION CARD** (shown above) should be filled in completely, signed and returned to Electrolux Home Products.

This Use and Care Guide provides operating instructions for your model. Use your unit only as instructed in this Use and Care Guide.

IMPORTANT SAFETY INSTRUCTIONS



WARNING

Please read all instructions before using this unit.

Definitions

 This is the safety alert symbol. It is used to alert you to potential personal injury hazards. Obey all safety messages that follow this symbol to avoid possible injury or death.



DANGER

DANGER indicates an imminently hazardous situation which, if not avoided, will result in death or serious injury.



WARNING

WARNING indicates a potentially hazardous situation which, if not avoided, could result in death or serious injury.



CAUTION

CAUTION indicates a potentially hazardous situation which, if not avoided, may result in minor or moderate injury.



IMPORTANT

IMPORTANT indicates installation, operation or maintenance information which is important but not hazard-related.



WARNING

For your safety

- Do not store or use gasoline or other flammable vapors and liquids in the vicinity of this unit or any other appliance. Read product labels for flammability and other warnings.
- Do not operate the unit in the presence of explosive fumes.
- Remove and discard any spacers used to secure the shelves during shipping. Small objects are a choke hazard to children. 
- Remove all staples from the carton. Staples can cause severe cuts, and also destroy finishes if they come in contact with other appliances or furniture.

IMPORTANT SAFETY INSTRUCTIONS

WARNING

Child Safety

- Destroy carton, plastic bags, and any exterior wrapping material immediately after the unit is unpacked. Children should never use these items for play. Cartons covered with rugs, bedspreads, plastic sheets or stretch wrap may become airtight chambers and can quickly cause suffocation.
- An empty, discarded appliance is a very dangerous attraction to children.
- Remove the door(s) of any appliance that is not in use, even if it is being discarded.

WARNING

Proper Disposal of Your Appliance

Risk of child entrapment

Child entrapment and suffocation are not problems of the past. Junked or abandoned appliances are still dangerous – even if they will sit for “just a few days”. If you are getting rid of your old appliance, please follow the instructions below to help prevent accidents.

We strongly encourage responsible appliance recycling/disposal methods. Check with your utility company or visit www.recyclemyoldfridge.com for more information on recycling your old appliance.

Before you throw away your old appliance:

- Remove door.
- Leave shelves in place so children may not easily climb inside.
- Have the refrigerant removed by a qualified technician.

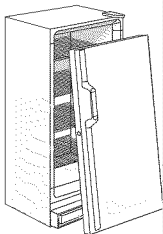

WARNING

Avoid fire hazard or electric shock. Do not use an extension cord or an adapter plug. Do not remove any prong from power cord.

Grounding type wall receptacle

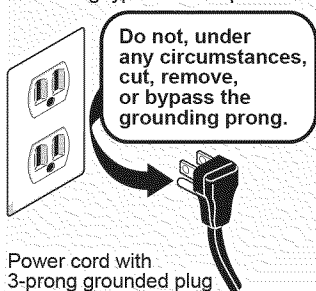

Power cord with 3-prong grounded plug

WARNING

Electrical Information

These guidelines must be followed to ensure that safety mechanisms in the design of this appliance will operate properly.

- Refer to the serial plate for correct electrical rating. The power cord of the appliance is equipped with a three-prong grounding plug for your protection against electrical shock hazards. It must be plugged directly into a properly grounded three-prong receptacle, protected with a 15-amp time delay fuse or circuit breaker. The receptacle must be installed in accordance with the local codes and ordinances. Consult a qualified electrician. Receptacles protected by Ground Fault Circuit Interrupters (GFCI) are NOT RECOMMENDED. Do NOT use an extension cord or adapter plug.
- If voltage varies by 10% or more, appliance performance may be affected. Operating the unit with insufficient power can damage the compressor. Such damage is not covered under the warranty. If you suspect your household voltage is high or low, consult your power company for testing.
- To prevent the appliance from being turned off accidentally, do not plug unit into an outlet controlled by a wall switch or pull cord.
- Do not pinch, knot, or bend power cord in any manner.

IMPORTANT SAFETY INSTRUCTIONS

FIRST STEPS

⚠ WARNING

Other Precautions

- Never unplug the unit by pulling on the power cord. Always grip the plug firmly and pull straight out from the receptacle.
- To avoid electrical shock, unplug the appliance before cleaning and before replacing a light bulb.
- Do not operate the unit in the presence of explosive fumes.

ℹ NOTE

Turning the temperature control to OFF turns off the compressor but does not disconnect power to the light bulb or other electrical components.

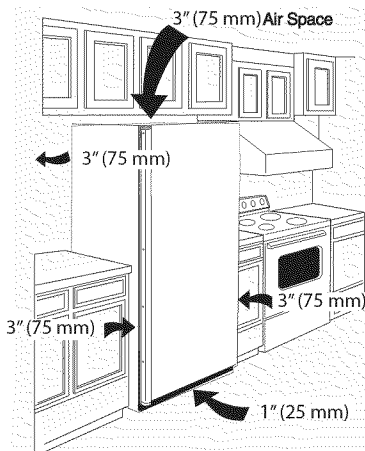

FIRST STEPS

This Use & Care Guide provides general operating instructions for your model. Use the unit only as instructed in this Use & Care Guide. **Before starting the unit, follow these important first steps.**

Location

Choose a place that is near a grounded electrical outlet.

For the most efficient operation, the appliance should be located where surrounding temperatures will not exceed 110°F (43°C). The Freeze Control Feature is designed to automatically maintain the selected interior temperature within these boundaries.

Allow space around the unit for good air circulation. Leave a 3 inch (75 mm) space on all sides of the unit for adequate circulation.

ℹ NOTE

The exterior walls of the unit may become quite warm as the compressor works to transfer heat from the inside. Temperatures as much as 30° F warmer than room temperature can be expected. For this reason it is particularly important in hotter climates to allow enough space for air circulation around your appliance.

Leveling

The appliance must have all bottom corners resting firmly on a solid floor. The floor must be strong enough to support a fully loaded unit.

ℹ NOTE

It is very important for your appliance to be level in order to function properly. If the unit is not leveled during installation, the door may be misaligned and not close or seal properly, causing cooling, frost, or moisture problems.

To Level Your Appliance:

After discarding crating screws, use a carpenter's level to level the unit from front-to-back. Adjust the plastic leveling feet in front, ½ bubble higher, so that the door closes easily when left halfway open.

Cleaning

Wash any removable parts of the appliance interior and exterior with mild detergent and warm water. Wipe dry. **DO NOT USE HARSH CLEANERS ON THESE SURFACES.**

Do not use razor blades or other sharp instruments which can scratch the appliance surface when removing adhesive labels. Any glue left from the tape can be removed with a mixture of warm water and mild detergent or the residue can be touched with the sticky side of tape already removed. **DO NOT REMOVE THE SERIAL PLATE.**



CAUTION

To allow door to close and seal properly, **DO NOT** let food packages extend past the front of shelves.

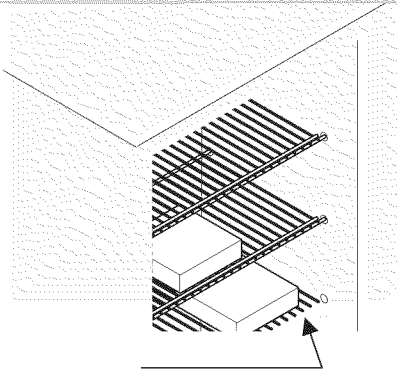

To install the shelf grommet to the shelf:

1. With the wire shelf installed, press the shelf grommet down onto the wire that is anchored into the appliance wall. Be sure to keep the larger end of the shelf grommet away from the wall.

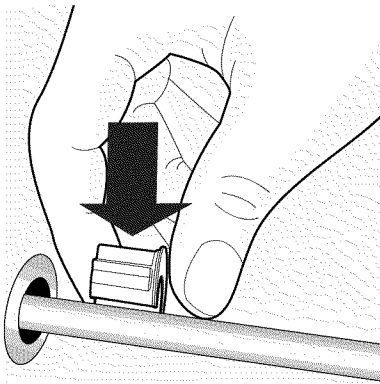

2. Push the shelf grommet onto the wire until it snaps in place.

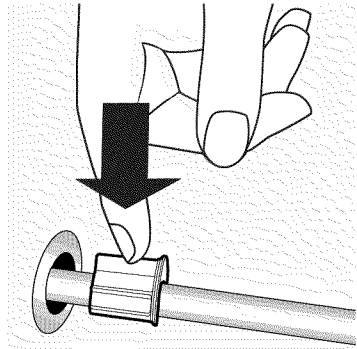

3. Slide the shelf grommet into the grommet already in the unit wall until it is flush.

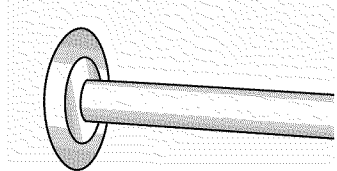

To install the handle clips to the basket:

1. Place the basket on a firm, flat surface.
2. With the narrow side of the handle clip on the inside of the basket, snap the handle clip to the recessed area in the basket.

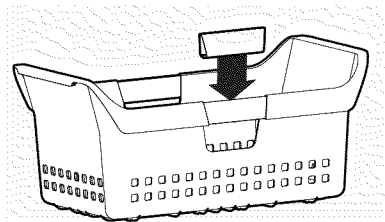
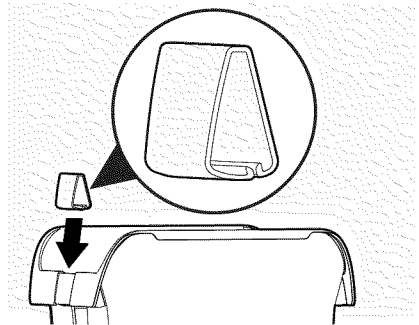

FIRST STEPS

3. Once the inside surface snaps in place, continue the process by rolling the handle clip slightly outward and pressing down firmly to snap onto the outside surface. If installed incorrectly, the handle clip will not lay flat.

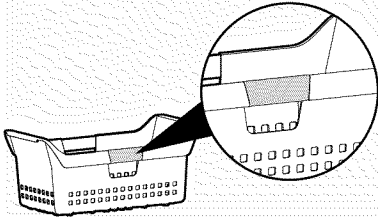

Door Removal

If door must be removed, unplug the unit.

1. Gently lay appliance on its back, on a rug or blanket.
2. Remove 2 base screws and base panel.
3. Remove wire from clips on bottom of cabinet if required.
4. Unplug connector, if required, by holding the cabinet connector in place, and pulling door connector out.
5. Remove bottom hinge screws.
6. Remove plastic top hinge cover.
7. Remove screws from top hinge.
8. Remove top hinge from cabinet.
9. Remove door and bottom hinge from cabinet.
10. To replace door, reverse the above order and securely tighten all screws to prevent hinge slippage.

SETTING THE TEMPERATURE CONTROL

Cool Down Period

For safe food storage, allow 4 hours for the unit to cool down completely. The appliance will run continuously for the first several hours.

Temperature Control

The temperature control is located inside the unit. The temperature is factory preset to provide satisfactory food storage temperatures. However, the temperature control is adjustable to provide a range of temperatures for your personal satisfaction. If a colder temperature is desired, turn the temperature control knob toward COLDEST, and allow several hours for temperatures to stabilize between adjustments.

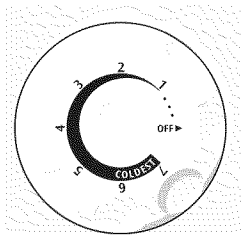

OPTIONAL FEATURES

NOTE

Your appliance may have some, or all of the features listed below. Become familiar with these features, and their use and care.

Tilt-Out Shelf

This shelf is located inside on the door and provides additional storage space. To access an item, tilt top of "basket" shelf down.

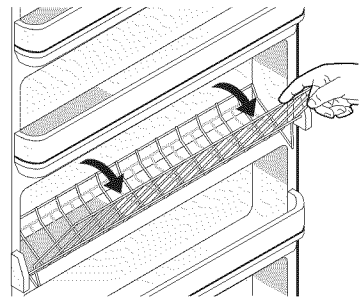

Adjustable Interior Shelves

Multi-position adjustable interior shelves can be moved to any position for larger or smaller packages. The shipping spacers that stabilize the shelves for shipping should be removed and discarded.

Slide-Out Basket (some models)

The slide-out basket located at the bottom of the unit provides separate storage space for items that are difficult to store on shelves. To remove the basket, pull out and lift up.

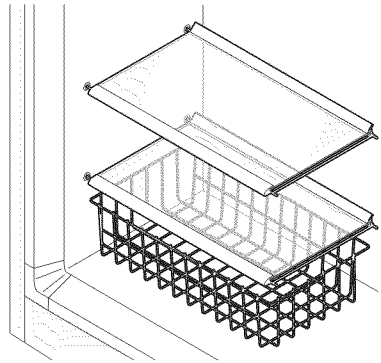

Adjustable Interior Shelves
and Slide-Out Basket

ENERGY-SAVING TIPS



- The appliance should be located in the coolest area of the room, away from heat-producing appliances or heating ducts, and out of direct sunlight.
- Level the unit so the door closes tightly.
- Do not overcrowd the appliance or block cold air vents. Doing so causes the unit to run longer and use more energy.
- Shelves should not be lined with aluminum foil, wax paper or paper toweling. Liners interfere with cold air circulation, making the appliance less efficient, which could cause food spoilage.
- Cover foods and wipe containers dry before placing them in the unit. This cuts down on moisture build-up inside the unit.
- Organize and label food to reduce door openings and extended searches. Remove as many items as needed at one time, and close door as soon as possible.

CARE AND CLEANING

Automatic Freeze Control

The Freeze Control Feature will maintain proper interior temperature even when the unit is placed in an area where the surrounding temperature drops down to 10° F (-12° C).

Interior Light

The light comes on automatically when the door is opened. To replace the light bulb, turn the temperature control to OFF and **unplug the electrical cord**. Replace the old bulb with a bulb of the same wattage.

Cleaning the Inside

Wash inside surfaces of the unit with a solution of 2 tbsp. (25 g) of baking soda in 1 qt. (1 l) warm water. Rinse and dry. Wring excess water out of the sponge or cloth when cleaning in the area of the controls, or any electrical parts.

Wash the removable parts with the baking soda solution mentioned above or mild detergent and warm water. Rinse and dry. **Never** use metallic scouring pads, brushes, abrasive cleaners, or alkaline solutions on any surface. Do not wash removable parts in a dishwasher.

Cleaning the Outside

Wash the cabinet with warm water and mild liquid detergent. Rinse well and wipe dry with a clean soft cloth.

WARNING

If leaving door open while on vacation, make certain that children cannot get into the appliance and become entrapped.

Vacation and Moving Tips

Vacations: If the unit will not be used for several months, remove all food and unplug the power cord. Clean and dry the interior thoroughly. Leave the door open slightly, blocking it open if necessary, to prevent odor and mold growth.

Moving: Disconnect the power cord plug from the wall outlet. Remove food and clean the appliance. Secure all loose items such as base panel, baskets, and shelves by taping them securely in place to prevent damage. In the moving vehicle, secure the unit in an upright position, and secure to prevent movement. Also protect outside of unit with a blanket, or similar item.

BEFORE YOU CALL

1-800-944-9044 (United States)
1-800-265-8352 (Canada)

Visit our web site at
www.frigidaire.com.

Before calling for service, review this list. It may save you time and expense. This list includes common occurrences that are not the result of defective workmanship or materials in this appliance.

PROBLEM	CAUSE	CORRECTION
APPLIANCE OPERATION		
Appliance does not run.	<ul style="list-style-type: none"> • Appliance is plugged into a circuit that has a ground fault interrupt. • Temperature Control is in the OFF position. • Appliance may not be plugged in or plug is loose. • House fuse blown or tripped circuit breaker. • Power outage 	<ul style="list-style-type: none"> • Use another circuit. If you are unsure about the outlet, have it checked by a certified technician. • See Setting the Temperature Control section. • Ensure plug is tightly pushed into outlet. • Check/replace fuse with a 15-amp time-delay fuse. Reset circuit breaker. • Check house lights. Call local electric company.
Appliance runs too much or too long.	<ul style="list-style-type: none"> • Room or outside weather is hot. • Appliance has recently been disconnected for a period of time. • Large amounts of warm or hot food have been stored recently. • Door is opened too frequently or too long. • Door may be slightly open. • Temperature control is set too low. • Gasket is dirty, worn, cracked, or poorly fitted. 	<ul style="list-style-type: none"> • It's normal for the appliance to work longer under these conditions. • It takes 4 hours for the appliance to cool down completely. • Warm food will cause appliance to run more until the desired temperature is reached. • Warm air entering the appliance causes it to run more. Open door less often. • See "DOOR PROBLEMS". • Turn control knob to a warmer setting. Allow several hours for the temperature to stabilize. • Clean or change gasket. Leaks in door seal will cause appliance to run longer in order to maintain desired temperatures.
APPLIANCE TEMPERATURES		
Interior temperature is too cold.	<ul style="list-style-type: none"> • Temperature control is set too low. 	<ul style="list-style-type: none"> • Set control to a warmer setting. Allow several hours for temperature to stabilize.
Temperature inside is too warm.	<ul style="list-style-type: none"> • Temperature control is set too warm. • Door is opened too frequently or too long. • Door may not be seating properly. • Large amounts of warm or hot food has been stored recently. • Appliance has recently been disconnected for a period of time. 	<ul style="list-style-type: none"> • Turn control to a colder setting. Allow several hours for temperature to stabilize. • Warm air enters the appliance every time the door is opened. Open door less often. • See "DOOR PROBLEMS". • Wait until the appliance has had a chance to reach its selected temperature. • Appliance requires 4 hours to cool down completely.
External temperature is too warm.	<ul style="list-style-type: none"> • The external walls can be as much as 30° F warmer than room temperature. 	<ul style="list-style-type: none"> • This is normal while the compressor works to transfer heat from inside the cabinet.

BEFORE YOU CALL

PROBLEM	CAUSE	CORRECTION
SOUND AND NOISE		
Louder sound levels when appliance is on.	<ul style="list-style-type: none"> Modern appliances have increased storage capacity and more stable temperatures. They require a high efficiency compressor. 	<ul style="list-style-type: none"> This is normal. When the surrounding noise is low, you might hear the compressor running while it cools the interior.
Longer sound levels when compressor comes on.	<ul style="list-style-type: none"> Appliance operates at higher pressures during the start of the ON cycle. 	<ul style="list-style-type: none"> This is normal. Sound will level off or disappear as appliance continues to run.
Fan runs when room temperature is below 45°F.	<ul style="list-style-type: none"> Exterior thermostat has activated the heater and fan. 	<ul style="list-style-type: none"> This is normal.
Popping or cracking sound when compressor comes on.	<ul style="list-style-type: none"> Metal parts undergo expansion and contraction, as in hot water pipes. 	<ul style="list-style-type: none"> This is normal. Sound will level off or disappear as appliance continues to run.
Bubbling or gurgling sound, like water boiling.	<ul style="list-style-type: none"> Refrigerant (used to cool appliance) is circulating throughout the system. 	<ul style="list-style-type: none"> This is normal.
Vibrating or rattling noise.	<ul style="list-style-type: none"> Appliance is not level. It rocks on the floor when it is moved slightly. Appliance is touching the wall. 	<ul style="list-style-type: none"> Level the unit. Refer to "Leveling" in the First Steps Section. Re-level the appliance or move appliance slightly. Refer to "Leveling" in the First Steps Section.
Snapping sound.	<ul style="list-style-type: none"> Cold Control turning the appliance on and off. 	<ul style="list-style-type: none"> This is normal.
WATER/MOISTURE/FROST INSIDE APPLIANCE		
Moisture forms on inside walls.	<ul style="list-style-type: none"> Weather is hot and humid. Door may not be seating properly. Door is opened too often or too long. 	<ul style="list-style-type: none"> This is normal. See "DOOR PROBLEMS". Open door less often.
WATER/MOISTURE/FROST OUTSIDE APPLIANCE		
Moisture forms on outside.	<ul style="list-style-type: none"> Door may not be seating properly, causing cold air from inside appliance to meet warm, moist air from outside. 	<ul style="list-style-type: none"> See "DOOR PROBLEMS".
ODOR IN APPLIANCE		
Odor in appliance.	<ul style="list-style-type: none"> Interior needs to be cleaned. Foods with strong odors are in the appliance. 	<ul style="list-style-type: none"> Clean interior with sponge, warm water, and baking soda. Cover the food tightly.
DOOR PROBLEMS		
Door will not close.	<ul style="list-style-type: none"> Appliance is not level. It rocks on the floor when it is moved slightly. 	<ul style="list-style-type: none"> This condition can force the cabinet out of square and misalign the door. Refer to "Leveling" in the First Steps Section.
LIGHT BULB IS NOT ON		
Light bulb is not on.	<ul style="list-style-type: none"> Light bulb may be burned out. No electric current is reaching the unit. 	<ul style="list-style-type: none"> Follow directions under "Interior Light" in the Optional Features Section. See "APPLIANCE OPERATION".

MAJOR APPLIANCE WARRANTY

Your appliance is covered by a one year limited warranty. For one year from your original date of purchase, Electrolux will pay all costs for repairing or replacing any parts of this appliance that prove to be defective in materials or workmanship when such appliance is installed, used and maintained in accordance with the provided instructions.

Exclusions **This warranty does not cover the following:**

1. Products with original serial numbers that have been removed, altered or cannot be readily determined.
2. Product that has been transferred from its original owner to another party or removed outside the USA or Canada.
3. Rust on the interior or exterior of the unit.
4. Products purchased "as-is" are not covered by this warranty.
5. Food loss due to any refrigerator or freezer failures.
6. Products used in a commercial setting.
7. Service calls which do not involve malfunction or defects in materials or workmanship, or for appliances not in ordinary household use or used other than in accordance with the provided instructions.
8. Service calls to correct the installation of your appliance or to instruct you how to use your appliance.
9. Expenses for making the appliance accessible for servicing, such as removal of trim, cupboards, shelves, etc., which are not a part of the appliance when it is shipped from the factory.
10. Service calls to repair or replace appliance light bulbs, air filters, water filters, other consumables, or knobs, handles, or other cosmetic parts.
11. Surcharges including, but not limited to, any after hour, weekend, or holiday service calls, tolls, ferry trip charges, or mileage expense for service calls to remote areas, including the state of Alaska.
12. Damages to the finish of appliance or home incurred during installation, including but not limited to floors, cabinets, walls, etc.
13. Damages caused by: services performed by unauthorized service companies; use of parts other than genuine Electrolux parts or parts obtained from persons other than authorized service companies; or external causes such as abuse, misuse, inadequate power supply, accidents, fires, or acts of God.

DISCLAIMER OF IMPLIED WARRANTIES; LIMITATION OF REMEDIES

CUSTOMER'S SOLE AND EXCLUSIVE REMEDY UNDER THIS LIMITED WARRANTY SHALL BE PRODUCT REPAIR OR REPLACEMENT AS PROVIDED HEREIN. CLAIMS BASED ON IMPLIED WARRANTIES, INCLUDING WARRANTIES OF MERCHANTABILITY OR FITNESS FOR A PARTICULAR PURPOSE, ARE LIMITED TO ONE YEAR OR THE SHORTEST PERIOD ALLOWED BY LAW, BUT NOT LESS THAN ONE YEAR. ELECTROLUX SHALL NOT BE LIABLE FOR CONSEQUENTIAL OR INCIDENTAL DAMAGES SUCH AS PROPERTY DAMAGE AND INCIDENTAL EXPENSES RESULTING FROM ANY BREACH OF THIS WRITTEN LIMITED WARRANTY OR ANY IMPLIED WARRANTY. SOME STATES AND PROVINCES DO NOT ALLOW THE EXCLUSION OR LIMITATION OF INCIDENTAL OR CONSEQUENTIAL DAMAGES, OR LIMITATIONS ON THE DURATION OF IMPLIED WARRANTIES, SO THESE LIMITATIONS OR EXCLUSIONS MAY NOT APPLY TO YOU. THIS WRITTEN WARRANTY GIVES YOU SPECIFIC LEGAL RIGHTS. YOU MAY ALSO HAVE OTHER RIGHTS THAT VARY FROM STATE TO STATE.

If You Need Service Keep your receipt, delivery slip, or some other appropriate payment record to establish the warranty period should service be required. If service is performed, it is in your best interest to obtain and keep all receipts. Service under this warranty must be obtained by contacting Electrolux at the addresses or phone numbers below.

This warranty only applies in the USA and Canada. In the USA, your appliance is warranted by Electrolux Major Appliances North America, a division of Electrolux Home Products, Inc. In Canada, your appliance is warranted by Electrolux Canada Corp. Electrolux authorizes no person to change or add to any obligations under this warranty. Obligations for service and parts under this warranty must be performed by Electrolux or an authorized service company. Product features or specifications as described or illustrated are subject to change without notice.

USA
1.800.944.9044
Frigidaire
10200 David Taylor Drive
Charlotte, NC 28262



Electrolux

Canada
1.800.265.8352
Electrolux Canada Corp.
5855 Terry Fox Way
Mississauga, Ontario, Canada
LSV 3E4